



## INDEX

S.No	Parameter	Page No.
1	Academic and Administrative Audit and Follow up Action Taken	2
2	Collaborative quality initiatives with other institution (s)	234
3	Participation in NIRF	1127
4	Quality audit recognized by state, national or international agencies (ISO Certification, NBA)	1130

Academic and  
Administrative Audit  
and  
Follow up Action  
Taken



# VIGNAN'S INSTITUTE OF MANAGEMENT AND TECHNOLOGY FOR WOMEN

Sponsored by Lavu Educational Society, Approved by AICTE, New Delhi & Affiliated to JNTUH, Hyderabad.  
Kondapur (V), Ghatkesar (M), Medchal - Malkajgiri (D) - 501 301 TS INDIA  
Phone: +08615 200006/07/08 Email: info@vmtw.in

## INTERNAL QUALITY ASSURANCE CELL

### ACADEMIC & ADMINISTRATIVE AUDIT REPORT Evaluation Sheet

Department Name : **Computer Science and Engineering**  
Programme Name : **B. Tech**  
Academic Year : **2017-18**

<b>I. PSOs, POs and Curriculum</b>		
<b>S.No</b>	<b>Parameter</b>	<b>Observations</b>
1.	PSO's and POs attainment.	Attainments calculated. File Available.
2.	PAC & DAC meetings	PAC:22-5-2017 DAC:05-05-2017 Files are maintained in the department.
3.	Stakeholder's feedback and evidence related to curriculum design.	Feedback is collected. File is Available.
4.	Percentage of lab component	Percentage of Lab Component : Based on number of Subjects:38.70 Based on number of Credits:30.1 Based on number of Contact Hours :18.50



  
PRINCIPAL  
Vignan's Institute of Management & Technology For Women  
Kondapur (V), Ghatkesar (M), Medchal-Malkajgiri (D)-501301  
Telangana State



## VIGNAN'S INSTITUTE OF MANAGEMENT AND TECHNOLOGY FOR WOMEN

Sponsored by Lavu Educational Society, Approved by AICTE, New Delhi & Affiliated to JNTUH, Hyderabad.  
Kondapur (V), Ghatkesar (M), Medchal - Malkajgiri (D) - 501 301 TS INDIA  
Phone: +08615 200006/07/08 Email: info@vmtw.in

### II. Faculty information and their contribution

S. No	Parameter	Observations
1.	Teacher- Student ratio	10.80
2.	Faculty Cadre Ratio	Professors : 3 Associate Professors: 3 Assistant Professors: 4
3.	Faculty Qualifications	Ph.D's: 4 Pursuing Ph.D:5 All the faculty have M.Tech/M.E/M.Sc./M.A/M.B.A:
4.	Faculty contribution in writing:	NIL
5.	Awards/Rewards received:	NIL
6.	Faculty in professional organizations: And faculty contribution:	IETE: NIL ISTE: NIL IEI: NIL SDIWC: NIL IAENG: NIL
7.	National level events organized -Conferences: -Workshops/ Seminars: -FDPs: International level events organized -Conferences: -Workshops/Seminars:	<b>EVENTS ORGANISED</b>  FDP: 00 WORKSHOPS : 03 SEMINARS: 02
8.	List of Conferences/seminars/ workshops / FDP's/ any exclusive programs attended for enrichment of teaching - learning process	International Conferences:2 <b>Workshops: 13</b> <b>FDP:2</b> <b>STTP:NIL</b>
9.	Faculty interaction with outside world (BOS/NBA/Examiner for PhD evaluation / selection committee / Academic auditing	NIL
10.	Faculty Load	Faculty load is distributed as per AICTE Norms. Details are made available in Work Load Particular file.



  
PRINCIPAL

Vignans Institute of Management & Technology For Women  
Kondapur (V), Ghatkesar (M), Medchal-Malkajgiri (D)-501301  
Telangana State



# VIGNAN'S INSTITUTE OF MANAGEMENT AND TECHNOLOGY FOR WOMEN

Sponsored by Lavu Educational Society, Approved by AICTE, New Delhi & Affiliated to JNTUH, Hyderabad.  
Kondapur (V), Ghatkesar (M), Medchal - Malkajgiri (D) - 501 301 TS INDIA  
Phone: +08615 200006/07/08 Email: info@vmtw.in

## III. Teaching-Learning Process and Evaluation

S. No	Parameter	Observations
1.	Student performance indices Attendance ,Exams	Detained List: NIL Result Analysis : (PASS PERCENTAGE): II-I : 45.79 II-II :85.85 III-I:72.63 III-II:77.08 IV-I:78.80 IV-II-87.5
2.	Mechanism and activities for slow learners for their improvement and outcomes	Slow Learners were identified based on their performance in Mid-Examinations. Remedial classes were conducted. Details of remedial classes are maintained in separate file.
3.	Student counseling/ mentoring mechanism	One faculty mentor attached to 20 students from I B. Tech. Mentors look after the career, academic and other issues related to mntee student. Mentor book is maintained for every student. <b>A separate file is maintained by every mentor (counselor) in the department.</b>
4.	Tutorial classes	Tutorial classes schedule is included in regular time table. Tutorial classes were conducted as per time table. Tutorial details are maintained in a separate file.
5.	Initiatives taken for innovative mini and major projects -Training for students & faculty	Workshops and guest lectures were organized. File is maintained in ther department.
6.	Best student projects with awards.	2 Projects were identified. Details are available in Project file.



  
PRINCIPAL

Vignans Institute of Management & Technology For Women  
Kondapur (V), Ghatkesar (M), Medchal-Malkajgiri (Dt)-501301  
Telangana State



# VIGNAN'S INSTITUTE OF MANAGEMENT AND TECHNOLOGY FOR WOMEN

Sponsored by Lavu Educational Society, Approved by AICTE, New Delhi & Affiliated to JNTUH, Hyderabad.  
Kondapur (V), Ghatkesar (M), Medchal - Malkajgiri (D) - 501 301 TS INDIA  
Phone: +08615 200006/07/08 Email: info@vmtw.in

7.	Monitoring of teaching--learning process -- Assessment of teaching process in Classrooms. -- Random verification of evaluated answer papers and question paper during the semester. -- Innovative teaching methods presented if any -- Verification of course files	1. HOD monitors the lesson plan for every 15 days through attendance register of the students for different subjects and also marks awarded in midterm examinations.  2. Department committee assesses whether faculty are following the bloom's taxonomy and pattern of question papers as per regulations.  3. PPT's and videos, if any, used by faculty are mentioned in the concerned course files.  Course files are verified by department and Department IQAC Co-ordinator before finalizing the calculation of CO and PO attainments in every semester.
8.	Training programs conducted for students Guest lecturers: Seminars/ workshops:	Training programs - NIL Workshops - NIL Seminars Guest lectures - NIL
9.	Students feedback	1. Feedbacks are collected every semester. 2. The feedback reports are available in the file. The follow up action is initiated only for that faculty who have a feedback less than 3 out of 5 scale. 3. There was no faculty having feedback less than 3 in this academic year Details are maintained in feedback file
10.	Feedback follow-up action	
11.	Scope for Self-learning Certificate courses Online courses	NPTEL No.of faculty Certified : NIL No.of Students Certified : NIL
12.	Placements (%): Industries / Organizations:	No. of Students: 08 No. of Students Placed : 07
13.	Higher studies (%): Institutions:	Students Higher studies: NIL Total No. of Institutions :NIL



  
PRINCIPAL

Vignans Institute of Management & Technology For Women  
Kondapur (V), Ghatkesar (M), Medchal-Malkajgiri (Dt)-501301  
Telangana State



# VIGNAN'S INSTITUTE OF MANAGEMENT AND TECHNOLOGY FOR WOMEN

Sponsored by Lavu Educational Society, Approved by AICTE, New Delhi & Affiliated to JNTUH, Hyderabad.  
Kondapur (V), Ghatkesar (M), Medchal - Malkajiri (D) - 501 301 TS INDIA  
Phone: +08615 200006/07/08 Email: info@vmtw.in

## IV. Research, Consultancy and Extension

Sl.No	Parameter	Observations
1.	Faculty publications in journals: Peer reviewed Journals:	International Journals : 0 National Journals : NIL Scopus Indexed : NIL SCI Indexed : 0
2.	Publications in conferences: - National: - International:	National : 0 International : 0
3.	PhDs -Registered: Submitted: Awarded: PhDs guiding /guided:	NIL
4.	Funded R&D projects and Consultancy work Applied: Ongoing: Completed:	Applied : 06 Ongoing : NIL Completed : 06 PhDs guiding /guided: NIL
5.	Faculty intellectual property rights	IPR : NIL
6.	R&D grants & projects and their outcomes.	06
7.	MOU's with industries/ R&D/ Premier institutes	MOU's with Industries : 04 R&D : NIL Premier Institutes : NIL
8.	Research centers of excellence established: Outcome in research centers:	NIL
9.	Faculty involved in research and Consultancy.	Number of faculty involved in research and Consultancy : 02



  
PRINCIPAL  
Vignans Institute of Management & Technology For Women  
Kondapur (V), Ghatkesar (M), Medchal-Malkajiri (Dt)-501301  
Telangana State



## VIGNAN'S INSTITUTE OF MANAGEMENT AND TECHNOLOGY FOR WOMEN

Sponsored by Lavu Educational Society, Approved by AICTE, New Delhi & Affiliated to JNTUH, Hyderabad.  
Kondapur (V), Ghatkesar (M), Medchal - Malkajgiri (Dt) - 501 301 TS INDIA  
Phone: +08615 200006/07/08 Email: info@vmtw.in

V. Infrastructure and Learning Resources		
Sl. No	Parameter	Observations
1.	Adequacy of infrastructural facilities to improve the teaching learning process Class rooms: Laboratories: ICT class rooms / e- Class Rooms: Seminar halls: Faculty rooms:	Class rooms : 06 Laboratories : 05 E-Class room : 03 Seminar halls : 01 Faculty Rooms : 01
2.	Internet facilities for faculty & Students:	1. Wi-Fi facility also provided to Staff and Students Laptops. 2. Internet facility provided to all computers in Laboratories. 3. Department Office and Staff rooms are having internet by LAN and Wi-Fi.
3.	Technical manpower support	Programmer - 04 Hardware Mechanic - NIL Lab. Technician - 01 Office Assistant - NIL Training Assistant - NIL Total manpower support - 05
4.	Modern / new equipment added in laboratories	60 - Intel Core 2 Duo computers were added.
5.	Details of computing facilities and Improvement.	All the Labs are equipped with adequate facilities as needed.
6.	Department level library resources with Details.	Text books :152 Digital Library: Can access through LAN



  
PRINCIPAL

Vignan's Institute of Management & Technology For Women  
Kondapur (V), Ghatkesar (M), Medchal-Malkajgiri (Dt)-501301  
Telangana State





# VIGNAN'S INSTITUTE OF MANAGEMENT AND TECHNOLOGY FOR WOMEN

Sponsored by Lavu Educational Society, Approved by AICTE, New Delhi & Affiliated to JNTUH, Hyderabad.  
Kondapur (V), Ghatkesar (M), Medchal - Malkajgiri (Dt) - 501 301 TS INDIA  
Phone: +08615 200006/07/08 Email: info@vmtw.in

## VI. Student information, Support and Progression

Sl. No	Parameter	Observations
1.	Add-on Courses	Add-on Courses: 06 Details on Add-on Courses are maintained in a file.
2.	Student prizes: Scholarships	1. Student Prizes - 11 2. Scholarship - 0 3. Department student clubs - 2
3.	Details of coaching provided for GATE/GRE/any other Competitive Exams.	Company Specific CRT Training is given to Students.
4.	Internships	Internships - NIL



  
PRINCIPAL  
Vignani's Institute of Management & Technology For Women  
Kondapur (V), Ghatkesar (M), Medchal-Malkajgiri (Dt)-501301  
Telangana State



# VIGNAN'S INSTITUTE OF MANAGEMENT AND TECHNOLOGY FOR WOMEN

Sponsored by Lavu Educational Society, Approved by AICTE, New Delhi & Affiliated to JNTUH, Hyderabad.  
Kondapur (V), Ghatkesar (M), Medchal - Malkajgiri (D) - 501 301 TS INDIA  
Phone: +08615 200006/07/08 Email: info@vmtw.in

## VII. Governance, Leadership and Management

Sl. No	Parameter	Observations
1.	Teaching and Non-Teaching staff attended for skill development programs	Teaching staff: 22 Non-teaching staff: 05
2.	MoUs with premier Institutions for knowledge exchange	NIL
3.	Quality policy & Quality objectives Committees & duties: Cells & duties:	IQAC monitoring the Quantitative and Qualitative measures.
4.	Maintenance factor -physical observation -Biometric -Attendance monitoring system	1. Attendance register (physical) is maintained for faculty in the department. It is countersigned by both HOD and Principal daily. 2. Student's attendance is monitored daily and absentee's information is sent to their parents through SMS. Monthly attendance percentage sent to their parents through letters by post. 3. Attendance registers of the students (physical) is maintained and countersigned by HOD regularly. 4. The Students having less than 75% attendance information is maintained and informed to the parents periodically.  <b>(Registers are maintained in Department office)</b>
5.	Financial support/leaves for qualification/skill up- gradation:	Financial support is given as per the institution policy. File related to this is maintained in the Department
6.	Risk evaluation/safety measures:	Safety measures are disseminated . Fire Extinguishers are provided in all laboratories.



  
PRINCIPAL  
Vignans Institute of Management & Technology For Women  
Kondapur (V), Ghatkesar (M), Medchal-Malkajgiri (Dt)-501301  
Telangana State



# VIGNAN'S INSTITUTE OF MANAGEMENT AND TECHNOLOGY FOR WOMEN

Sponsored by Lavu Educational Society, Approved by AICTE, New Delhi & Affiliated to JNTUH, Hyderabad.  
Kondapur (V), Ghatkesar (M), Medchal - Malkajiri (D) - 501 301 TS INDIA  
Phone: +08615 200006/07/08 Email: info@vmtw.in

## 1. Suggestions for improvement:

1. No Research Projects.
2. Quality Publications are very Less.
3. Research rigor among faculty is to be focused.

Sign of Department Coordinator:

  
(Vinay Bhushan)

Sign of Academic Auditors 1.

  
(Senthush Kumar K)

2.

  
J. Srilakshmi

3.

  
(K. Bharathi Reddy)

Sign of HOD:

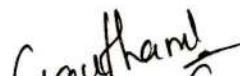
  
(A. Gauthamitha)

**Head of the Department**  
**Computer Science and Engineering**  
Vignan's Institute of Management and Technology for Women  
Kondapur (V), Ghatkesar (M), R.R. Dist-501 301.

Sign of IQAC Coordinator:

  
Co-ordinator  
Internal Quality Assurance Cell  
Vignan's Institute of Management & Technology For Women  
Kondapur (V), Ghatkesar (M), Medchal-Malkajiri (Dt)-501301  
Telangana State



  
PRINCIPAL

Vignan's Institute of Management & Technology For Women  
Kondapur (V), Ghatkesar (M), Medchal-Malkajiri (Dt)-501301  
Telangana State



# VIGNAN'S INSTITUTE OF MANAGEMENT AND TECHNOLOGY FOR WOMEN

Sponsored by Lavu Educational Society, Approved by AICTE, New Delhi & Affiliated to JNTUH, Hyderabad.  
Kondapur (V), Ghatkesar (M), Medchal - Malkajiri (D) - 501 301 TS INDIA  
Phone: +08615 200006/07/08 Email: info@vmtw.in

## INTERNAL QUALITY ASSURANCE CELL

### ACADEMIC & ADMINISTRATIVE AUDIT REPORT

#### Evaluation Sheet

Department Name : BSH  
Programme Name : B. Tech  
Academic Year : 2017-18

I. PSOs, POs and Curriculum		
S.No	Parameter	Observations
1.	PSO's and POs attainment.	Attainments calculated. File Available.
2.	DAC meetings	DAC Meeting:19-07-2017 & 08-12-2017. Files are maintained in the department.
3.	Stakeholder's feedback and evidence related to curriculum design.	Feedback is collected. File is Available.
4.	Percentage of lab component	Percentage of Lab Component : Based on number of Subjects:31.25% Based on number of Credits:20.83% Based on number of Contact Hours :32.75%



  
PRINCIPAL  
Vignan's Institute of Management & Technology For Women  
Kondapur (V), Ghatkesar (M), Medchal-Malkajiri (Dt)-501301  
Telangana State



# VIGNAN'S INSTITUTE OF MANAGEMENT AND TECHNOLOGY FOR WOMEN

Sponsored by Lavu Educational Society, Approved by AICTE, New Delhi & Affiliated to JNTUH, Hyderabad.

Kondapur (V), Ghatkesar (M), Medchal - Malkajgiri (Dt) - 501 301 TS INDIA

Phone: +08615 200006/07/08

Email: info@vmtw.in

## II. Faculty information and their contribution

S. No	Parameter	Observations
1.	Teacher- Student ratio	13.50
2.	Faculty Cadre Ratio	Professors : 1 Associate Professors: 2 Assistant Professors: 13
3.	Faculty Qualifications	Ph.D's: 1 Pursuing Ph.D: Nil All the faculty have M.Tech/M.E/M.Sc./M.A/M.B.A: 15
4.	Faculty contribution in writing:	NIL
5.	Awards/Rewards received:	NIL
6.	Faculty in professional organizations: And faculty contribution:	NIL
7.	National level events organized -Conferences: -Workshops/ Seminars: -FDPs: International level events organized -Conferences: -Workshops/Seminars:	NIL
8.	List of Conferences/seminars/ workshops / FDP's/ any exclusive programs attended for enrichment of teaching - learning process	International Conferences: 5 National Conference: 8 Workshops: Nil FDP's: 15
9.	Faculty interaction with outside world (BOS/NBA/Examiner for PhD evaluation / selection committee / Academic auditing	NIL
10.	Faculty Load	Faculty load is distributed as per AICTE Norms. Details are made available in Work Load Particular file.



*ASH*

PRINCIPAL

Vignan's Institute of Management & Technology For Women  
Kondapur (V), Ghatkesar (M), Medchal-Malkajgiri (Dt)-501301  
Telangana State



# VIGNAN'S INSTITUTE OF MANAGEMENT AND TECHNOLOGY FOR WOMEN

Sponsored by Lavu Educational Society, Approved by AICTE, New Delhi & Affiliated to JNTUH, Hyderabad.

Kondapur (V), Ghatkesar (M), Medchal - Malkajgiri (D) - 501 301 TS INDIA

Phone: +08615 200006/07/08

Email: info@vmtw.in

## III. Teaching-Learning Process and Evaluation

S. No	Parameter	Observations
1.	Student performance indices Attendance ,Exams	Detained List: I-I : 08 I-II : 01  Result Analysis: Pass Percentage I-I : 67.13% I-II : 65.99%
2.	Mechanism and activities for slow learners for their improvement and outcomes	Slow Learners were identified based on their performance in Mid-Examinations. Remedial classes were conducted. Details of remedial classes are maintained in separate file.
3.	Student counseling/ mentoring mechanism	One faculty mentor attached to 20 students from I B. Tech. Mentors look after the career, academic and other issues related to mntee student. Mentor book is maintained for every student. <b>A separate file is maintained by every mentor (counselor) in the department.</b>
4.	Tutorial classes	Tutorial classes schedule is included in regular time table. Tutorial classes were conducted as per time table. Tutorial details are maintained in a separate file.
5.	Initiatives taken for innovative mini and major projects -Training for students & faculty	NIL
6.	Best student projects with awards.	NIL



  
PRINCIPAL  
Vignans Institute of Management & Technology For Women  
Kondapur (V), Ghatkesar (M), Medchal-Malkajgiri (Dt)-501301  
Telangana State



# VIGNAN'S INSTITUTE OF MANAGEMENT AND TECHNOLOGY FOR WOMEN

Sponsored by Lavu Educational Society, Approved by AICTE, New Delhi & Affiliated to JNTUH, Hyderabad.

Kondapur (V), Ghatkesar (M), Medchal - Malkajgiri (D) - 501 301 TS INDIA

Phone: +08615 200006/07/08

Email: info@vmtw.in

7.	Monitoring of teaching--learning process -- Assessment of teaching process in Classrooms. -- Random verification of evaluated answer papers and question paper during the semester. -- Innovative teaching methods presented if any -- Verification of course files	1. HOD monitors the lesson plan for every 15 days through attendance register of the students for different subjects and also marks awarded in midterm examinations.  2. Department committee assesses whether faculty are following the bloom's taxonomy and pattern of question papers as per regulations.  3. PPT's and videos, if any, used by faculty are mentioned in the concerned course files.  Course files are verified by department and Department IQAC Co-ordinator before finalizing the calculation of CO and PO attainments in every semester.
8.	Training programs conducted for students Guest lecturers: Seminars/ workshops:	Training programs - Workshops - Nil Seminars - Nil Guest lecturers - 3
9.	Students feedback	1. Feedbacks are collected every semester. 2. The feedback reports are available in the file. The follow up action is initiated only for that faculty who have a feedback less than 3 out of 5 scale. 3. There was no faculty having feedback less than 3 in this academic year 2019-20.
10.	Feedback follow-up action	Details are maintained in feedback file
11.	Scope for Self-learning Certificate courses Online courses	NIL
12.	Placements (%): Industries / Organizations:	NA
13.	Higher studies (%): Institutions:	NA



*[Signature]*

PRINCIPAL

Vignans Institute of Management & Technology For Women  
Kondapur (V), Ghatkesar (M), Medchal-Malkajgiri (D)-501301  
Telangana State



# VIGNAN'S INSTITUTE OF MANAGEMENT AND TECHNOLOGY FOR WOMEN

Sponsored by Lavu Educational Society, Approved by AICTE, New Delhi & Affiliated to JNTUH, Hyderabad.  
Kondapur (V), Ghatkesar (M), Medchal - Malkajgiri (Dt) - 501 301 TS INDIA  
Phone: +08615 200006/07/08 Email: info@vmtw.in

## IV. Research, Consultancy and Extension

Sl.No	Parameter	Observations
1.	Faculty publications in journals: Peer reviewed Journals:	International Journals : 2 Scopus Indexed : 0 SCI Indexed : 0 <b>Details are also Maintained in separate file-Publication File</b>
2.	Publications in conferences: - National: - International:	National : 0 International : 0 Scopus : 0 SCI : 0
3.	PhDs -Registered: Submitted: Awarded:  PhDs guiding /guided:	NIL
4.	Funded R&D projects and Consultancy work Applied: Ongoing: Completed:	NIL
5.	Faculty intellectual property rights	IPR : NIL
6.	R&D grants & projects and their outcomes.	NIL
7.	MOU's with industries/ R&D/ Premier institutes	NIL
8.	Research centers of excellence established:  Outcome in research centers:	NIL
9.	Faculty involved in research and Consultancy.	NIL



*ASH*

PRINCIPAL

Vignan's Institute of Management & Technology For Women  
Kondapur (V), Ghatkesar (M), Medchal-Malkajgiri (Dt)-501301  
Telangana State





# VIGNAN'S INSTITUTE OF MANAGEMENT AND TECHNOLOGY FOR WOMEN

Sponsored by Lavu Educational Society, Approved by AICTE, New Delhi & Affiliated to JNTUH, Hyderabad.  
Kondapur (V), Ghatkesar (M), Medchal - Malkajgiri (Dt) - 501 301 TS INDIA  
Phone: +08615 200006/07/08 Email: info@vmtw.in

## V. Infrastructure and Learning Resources

Sl. No	Parameter	Observations
1.	Adequacy of infrastructural facilities to improve the teaching learning process Class rooms: Laboratories: ICT class rooms / e- Class Rooms: Seminar halls: Faculty rooms:	Class rooms : 05 Laboratories : 04 E-Class room : 01 Seminar halls : 01 Faculty Rooms : 01
2.	Internet facilities for faculty & Students:	1. Wi-Fi facility also provided to Staff and Students Laptops. 2. Internet facility provided to all computers in Laboratories. 3. Department Office and Staff rooms are having internet by LAN and Wi-Fi.
3.	Technical manpower support	Lab. Technician - 05 Office Assistant - 01 Training Assistant - 00 <b>Total manpower support - 06</b>
4.	Modern / new equipment added in laboratories	NIL
5.	Details of computing facilities and Improvement.	All the Labs are equipped with adequate facilities as needed.
6.	Department level library resources with Details.	Text books --30



  
PRINCIPAL  
Vignan's Institute of Management & Technology For Women  
Kondapur (V), Ghatkesar (M), Medchal-Malkajgiri (Dt)-501301  
Telangana State



# VIGNAN'S INSTITUTE OF MANAGEMENT AND TECHNOLOGY FOR WOMEN

Sponsored by Lavu Educational Society, Approved by AICTE, New Delhi & Affiliated to JNTUH, Hyderabad.  
Kondapur (V), Ghatkesar (M), Medchal - Malkajgiri (D) - 501 301 TS INDIA  
Phone: +08615 200006/07/08 Email: info@vmtw.in

## VI. Student information, Support and Progression

Sl. No	Parameter	Observations
1.	Induction Programs	Induction Program was conducted for newly joined First students. File is maintained in the department.
2.	Student prizes: Scholarships	1. Student Prizes -08 2. Scholarship - 0
3.	Details of coaching provided for GATE/GRE/any other Competitive Exams.	NIL
4.	Internships	NIL



  
PRINCIPAL  
Vignan's Institute of Management & Technology For Women  
Kondapur (V), Ghatkesar (M), Medchal-Malkajgiri (Dt)-501301  
Telangana State



# VIGNAN'S INSTITUTE OF MANAGEMENT AND TECHNOLOGY FOR WOMEN

Sponsored by Lavu Educational Society, Approved by AICTE, New Delhi & Affiliated to JNTUH, Hyderabad.  
Kondapur (V), Ghatkesar (M), Medchal - Malkajgiri (D) - 501 301 TS INDIA  
Phone: +08615 200006/07/08 Email: info@vmtw.in

## VII. Governance, Leadership and Management

Sl. No	Parameter	Observations
1.	Teaching and Non-Teaching staff attended for skill development programs	Teaching staff: Nil Non-teaching staff : 06 NPTEL online certificate courses Number of faculty Certified : Nil
2.	MoUs with premier Institutions for knowledge exchange	NIL
3.	Quality policy & Quality objectives Committees & duties: Cells & duties:	IQAC monitoring the Quantitative and Qualitative measures.
4.	Maintenance factor -physical observation -Biometric -Attendance monitoring system	<ol style="list-style-type: none"><li>1. Attendance register (physical) is maintained for faculty in the department. It is countersigned by both HOD and Principal daily.</li><li>2. Student's attendance is monitored daily and absentee's information is sent to their parents through SMS. Monthly attendance percentage sent to their parents through letters by post.</li><li>3. Attendance registers of the students (physical) is maintained and countersigned by HOD regularly.</li><li>4. The Students having less than 75% attendance information is maintained and informed to the parents periodically.</li></ol> <p><b>(Registers are maintained in Department office)</b></p>
5.	Financial support/leaves for qualification/skill up- gradation:	Financial support is given as per the institution policy.
6.	Risk evaluation/safety measures:	Safety measures are disseminated . Fire Extinguishers are provided in all laboratories.



  
PRINCIPAL

Vignans Institute of Management & Technology For Women  
Kondapur (V), Ghatkesar (M), Medchal-Malkajgiri (Dt)-501301  
Telangana State



# VIGNAN'S INSTITUTE OF MANAGEMENT AND TECHNOLOGY FOR WOMEN

Sponsored by Lavu Educational Society, Approved by AICTE, New Delhi & Affiliated to JNTUH, Hyderabad.  
Kondapur (V), Ghatkesar (M), Medchal - Malkajiri (D) - 501 301 TS INDIA  
Phone: +08615 200006/07/08 Email: info@vmtw.in

## 1. Suggestions for improvement:

1. No Research Projects.
2. Publications are very Less.
3. Research rigor among faculty is to be focused.

Sign of Department Coordinator:

T. Dileep

Sign of Academic Auditors 1.

2.   
(Sankar Kumar)

3.   
(L. Bhram Reddy)

Sign of HOD:

Head of the Department:  
**Basic Sciences and Humanitic**  
Vignan's Institute of Management and Technology for Women  
Kondapur (V), Ghatkesar (M) R R Dist-501 301

Sign of IQAC Coordinator:

Co-ordinator  
Internal Quality Assurance Cell  
Vignan's Institute of Management & Technology For Women  
Kondapur (V), Ghatkesar (M), Medchal-Malkajiri (Dt)-501301  
Telangana State



PRINCIPAL  
Vignan's Institute of Management & Technology For Women  
Kondapur (V), Ghatkesar (M), Medchal-Malkajiri (Dt)-501301  
Telangana State



# VIGNAN'S INSTITUTE OF MANAGEMENT AND TECHNOLOGY FOR WOMEN

Sponsored by Lavu Educational Society, Approved by AICTE, New Delhi & Affiliated to JNTUH, Hyderabad.

Kondapur (V), Ghatkesar (M), Medchal - Malkajiri (D) - 501 301 TS INDIA

Phone: +08615 200006/07/08

Email: info@vmtw.in

## INTERNAL QUALITY ASSURANCE CELL

### ACADEMIC & ADMINISTRATIVE AUDIT REPORT

#### Evaluation Sheet

Department Name : ECE  
Programme Name : B. Tech  
Academic Year : 2017-18

I. PSOs, POs and Curriculum		
S.No	Parameter	Observations
1.	PSO's and POs attainment.	Attainments calculated. File Available.
2.	PAC / DAC meetings	DAC Meeting:10/7/2017 and 7/12/2017 PAC Meeting :7/7/2017  Files are maintained in the department.
3.	Stakeholder's feedback and evidence related to curriculum design.	Feedback is collected.  File is Available.
4.	Percentage of lab component	Percentage of Lab Component : Based on number of Subjects:38.70 Based on number of Credits:17.64 Based on number of Contact Hours :28.34



  
PRINCIPAL

Vignan's Institute of Management & Technology For Women  
Kondapur (V), Ghatkesar (M), Medchal-Malkajiri (Dt)-501301  
Telangana State



# VIGNAN'S INSTITUTE OF MANAGEMENT AND TECHNOLOGY FOR WOMEN

Sponsored by Lavu Educational Society, Approved by AICTE, New Delhi & Affiliated to JNTUH, Hyderabad.  
Kondapur (V), Ghatkesar (M), Medchal - Malkajiri (D) - 501 301 TS INDIA  
Phone: +08615 200006/07/08 Email: info@vmtw.in

## II. Faculty information and their contribution

S. No	Parameter	Observations
1.	Teacher- Student ratio	(183/13)=14.08
2.	Faculty Cadre Ratio	Professors : 1 Associate Professors: 4 Assistant Professors: 8
3.	Faculty Qualifications	Ph.D's: 3 Pursuing Ph.D:3 All the faculty have M.Tech/M.E/M.Sc./M.A/M.B.A:
4.	Faculty contribution in writing:	NIL
5.	Awards/Rewards received:	NIL
6.	Faculty in professional organizations: And faculty contribution:	IETE :1 ORCID :1
7.	National level events organized -Conferences: -Workshops/ Seminars: -FDPs: International level events organized -Conferences: -Workshops/Seminars:	EVENTS ORGANISED  FDP: 1 WORKSHOPS : 1 SEMINARS: 5
8.	List of Conferences/seminars/ workshops / FDP's/ any exclusive programs attended for enrichment of teaching - learning process	FDP:3 WORKSHOP : 4 CONFERENCES: NIL
9.	Faculty interaction with outside world (BOS/NBA/Examiner for PhD evaluation / selection committee / Academic auditing	NIL
10.	Faculty Load	Faculty load is distributed as per AICTE Norms. Details are made available in Work Load Particular file.



  
PRINCIPAL

Vignan's Institute of Management & Technology For Women  
Kondapur (V), Ghatkesar (M), Medchal-Malkajiri (Dt)-501301  
Telangana State



# VIGNAN'S INSTITUTE OF MANAGEMENT AND TECHNOLOGY FOR WOMEN

Sponsored by Lavu Educational Society, Approved by AICTE, New Delhi & Affiliated to JNTUH, Hyderabad.  
Kondapur (V), Ghatkesar (M), Medchal - Malkajgiri (D) - 501 301 TS INDIA  
Phone: +08615 200006/07/08 Email: info@vmtw.in

## III. Teaching-Learning Process and Evaluation

S. No	Parameter	Observations
1.	Student performance indices Attendance ,Exams	Detained List: II-I:4 III-I:1 Result Analysis : (PASS PERCENTAGE): II-I : 60.00 II-II :78.82 III-I:75.95 III-II:43.04 IV-I:50 IV-II-100
2.	Mechanism and activities for slow learners for their improvement and outcomes	Slow Learners were identified based on their performance in Mid-Examinations. Remedial classes were conducted. Details of remedial classes are maintained in separate file.
3.	Student counseling/ mentoring mechanism	One faculty mentor attached to 20 students from I B. Tech. Mentors look after the career, academic and other issues related to mntee student. Mentor book is maintained for every student. <b>A separate file is maintained by every mentor (counselor) in the department.</b>
4.	Tutorial classes	Tutorial classes schedule is included in regular time table. Tutorial classes were conducted as per time table. Tutorial details are maintained in a separate file.
5.	Initiatives taken for innovative mini and major projects -Training for students & faculty	Workshops and guest lectures were organized. File is maintained in ther department.
6.	Best student projects with awards.	2 Projects were identified. Details are available in Project file.



  
PRINCIPAL  
Vignans Institute of Management & Technology For Women  
Kondapur (V), Ghatkesar (M), Medchal-Malkajgiri (Dt)-501301  
Telangana State



# VIGNAN'S INSTITUTE OF MANAGEMENT AND TECHNOLOGY FOR WOMEN

Sponsored by Lavu Educational Society, Approved by AICTE, New Delhi & Affiliated to JNTUH, Hyderabad.

Kondapur (V), Ghatkesar (M), Medchal - Malkajiri (D) - 501 301 TS INDIA

Phone: +08615 200006/07/08

Email: info@vmtw.in

7.	Monitoring of teaching--learning process -- Assessment of teaching process in Classrooms. -- Random verification of evaluated answer papers and question paper during the semester. -- Innovative teaching methods presented if any -- Verification of course files	<ol style="list-style-type: none"><li>1. HOD monitors the lesson plan for every 15 days through attendance register of the students for different subjects and also marks awarded in midterm examinations.</li><li>2. Department committee assesses whether faculty are following the bloom's taxonomy and pattern of question papers as per regulations.</li><li>3. PPT's and videos, if any, used by faculty are mentioned in the concerned course files.</li></ol> <p>Course files are verified by department and Department IQAC Co-ordinator before finalizing the calculation of CO and PO attainments in every semester.</p>
8.	Training programs conducted for students Guest lecturers: Seminars/ workshops:	Training programs Workshops -4 Seminars Guest lectures -4
9.	Students feedback	<ol style="list-style-type: none"><li>1. Feedbacks are collected every semester.</li><li>2. The feedback reports are available in the file. The follow up action is initiated only for that faculty who have a feedback less than 3 out of 5 scale.</li><li>3. There was no faculty having feedback less than 3 in this academic year Details are maintained in feedback file</li></ol>
10.	Feedback follow-up action	
11.	Scope for Self-learning Certificate courses Online courses	NIL
12.	Placements (%): Industries / Organizations:	No. of Students:4 No. of Students Placed : 4
13.	Higher studies (%): Institutions:	Students Higher studies: NIL Total No. of Institutions :NIL



PRINCIPAL

Vignans Institute of Management & Technology For Women  
Kondapur (V), Ghatkesar (M), Medchal-Malkajiri (D)-501301  
Telangana State





# VIGNAN'S INSTITUTE OF MANAGEMENT AND TECHNOLOGY FOR WOMEN

Sponsored by Lavu Educational Society, Approved by AICTE, New Delhi & Affiliated to JNTUH, Hyderabad.  
Kondapur (V), Ghatkesar (M), Medchal - Malkajgiri (D) - 501 301 TS INDIA  
Phone: +08615 200006/07/08 Email: info@vmtw.in

## IV. Research, Consultancy and Extension

Sl.No	Parameter	Observations
1.	Faculty publications in journals: Peer reviewed Journals:	International Journals : 1 National Journals : NIL Scopus Indexed : NIL SCI Indexed : 0
2.	Publications in conferences: - National: - International:	National : 0 International : 0
3.	PhDs -Registered: Submitted: Awarded: PhDs guiding /guided:	NIL
4.	Funded R&D projects and Consultancy work Applied: Ongoing: Completed:	Applied : 1 Ongoing : NIL Completed : 1
5.	Faculty intellectual property rights	IPR : NIL
6.	R&D grants & projects and their outcomes.	NIL
7.	MOU's with industries/ R&D/ Premier institutes	MOU's with Industries : 2 R&D : 1 Premier Institutes : NIL
8.	Research centers of excellence established: Outcome in research centers:	NIL
9.	Faculty involved in research and Consultancy.	Number of faculty involved in research and Consultancy : 1



  
PRINCIPAL

Vignan's Institute of Management & Technology For Women,  
Kondapur (V), Ghatkesar (M), Medchal-Malkajgiri (Dt)-501301  
Telangana State



# VIGNAN'S INSTITUTE OF MANAGEMENT AND TECHNOLOGY FOR WOMEN

Sponsored by Lavu Educational Society, Approved by AICTE, New Delhi & Affiliated to JNTUH, Hyderabad.

Kondapur (V), Ghatkesar (M), Medchal - Malkajgiri (D) - 501 301 TS INDIA

Phone: +08615 200006/07/08

Email: info@vmtw.in

## V. Infrastructure and Learning Resources

Sl. No	Parameter	Observations
1.	Adequacy of infrastructural facilities to improve the teaching learning process Class rooms: Laboratories: ICT class rooms / e- Class Rooms: Seminar halls: Faculty rooms:	Class rooms : 5 Laboratories : 12 E-Class room : 1 Seminar halls : 1 Faculty Rooms : 1
2.	Internet facilities for faculty & Students:	1. Wi-Fi facility also provided to Staff and Students Laptops. 2. Internet facility provided to all computers in Laboratories. 3. Department Office and Staff rooms are having internet by LAN and Wi-Fi.
3.	Technical manpower support	Lab Assistant -7 Lab. Technician -1 Total manpower support - 8
4.	Modern / new equipment added in laboratories	30-Components are added in AE lab
5.	Details of computing facilities and Improvement.	All the Labs are equipped with adequate facilities as needed.
6.	Department level library resources with Details.	Text books -110 Digital Library: Can access through LAN



  
PRINCIPAL

Vignans Institute of Management & Technology For Women  
Kondapur (V), Ghatkesar (M), Medchal-Malkajgiri (Dt)-501301  
Telangana State



# VIGNAN'S INSTITUTE OF MANAGEMENT AND TECHNOLOGY FOR WOMEN

Sponsored by Lavu Educational Society, Approved by AICTE, New Delhi & Affiliated to JNTUH, Hyderabad.  
Kondapur (V), Ghatkesar (M), Medchal - Malkajiri (D) - 501 301 TS INDIA  
Phone: +08615 200006/07/08 Email: info@vmtw.in

## VI. Student information, Support and Progression

Sl. No	Parameter	Observations
1.	Add-on Courses	Add-on Courses: 3 Details on Add-on Courses are maintained in a file.
2.	Student prizes: Scholarships	1. Student Prizes – 8 2. Scholarship – 0 3. Department student clubs – 3
3.	Details of coaching provided for GATE/GRE/any other Competitive Exams.	Company Specific CRT Training is given to Students.
4.	Internships	Internships 4



  
PRINCIPAL  
Vignans Institute of Management & Technology For Women  
Kondapur (V), Ghatkesar (M), Medchal-Malkajiri (Dt)-501301  
Telangana State



# VIGNAN'S INSTITUTE OF MANAGEMENT AND TECHNOLOGY FOR WOMEN

Sponsored by Lavu Educational Society, Approved by AICTE, New Delhi & Affiliated to JNTUH, Hyderabad.  
Kondapur (V), Ghatkesar (M), Medchal - Malkajgiri (D) - 501 301 TS INDIA  
Phone: +08615 200006/07/08 Email: info@vmtw.in

## VII. Governance, Leadership and Management

Sl. No	Parameter	Observations
1.	Teaching and Non-Teaching staff attended for skill development programs	Teaching staff: 1 Non-teaching staff: 1 NPTEL online Certificate courses no of faulty certified: NIL
2.	MoUs with premier Institutions for knowledge exchange	1
3.	Quality policy & Quality objectives Committees & duties: Cells & duties:	IQAC monitoring the Quantitative and Qualitative measures.
4.	Maintenance factor -physical observation -Biometric -Attendance monitoring system	1. Attendance register (physical) is maintained for faculty in the department. It is countersigned by both HOD and Principal daily. 2. Student's attendance is monitored daily and absentee's information is sent to their parents through SMS. Monthly attendance percentage sent to their parents through letters by post. 3. Attendance registers of the students (physical) is maintained and countersigned by HOD regularly. 4. The Students having less than 75% attendance information is maintained and informed to the parents periodically.  <b>(Registers are maintained in Department office)</b>
5.	Financial support/leaves for qualification/skill up- gradation:	Financial support is given as per the institution policy. File related to this is maintained in the Department
6.	Risk evaluation/safety measures:	Safety measures are disseminated . Fire Extinguishers are provided in all laboratories.



  
PRINCIPAL

Vignans Institute of Management & Technology For Women  
Kondapur (V), Ghatkesar (M), Medchal-Malkajgiri (Dt)-501301  
Telangana State



# VIGNAN'S INSTITUTE OF MANAGEMENT AND TECHNOLOGY FOR WOMEN

Sponsored by Lavu Educational Society, Approved by AICTE, New Delhi & Affiliated to JNTUH, Hyderabad.  
Kondapur (V), Ghatkesar (M), Medchal - Malkajiri (D) - 501 301 TS INDIA  
Phone: +08615 200006/07/08 Email: info@vmtw.in

## 1. Suggestions for improvement:

1. No Research Projects.
2. Publications are very Less.
3. Research rigor among faculty is to be focused.

Sign of Department Coordinator:

  
(E. Nagaraju)

Sign of Academic Auditors 1.

  
(Santhosh Kumar K.)

2.   
J. Srilakshmi

3.   
(K. Anant Reddy)

Sign of HOD:

  
Dr. A. Narmada

**Head of the Department**  
**Electronics and Communication Engineering**  
Vignans Institute of Management & Technology For Women  
Kondapur (V), Ghatkesar (M), Medchal-Malkajiri (Dt)-501301

Sign of IQAC Coordinator:

  
Co-ordinator  
Internal Quality Assurance Cell  
Vignans Institute of Management & Technology For Women  
Kondapur (V), Ghatkesar (M), Medchal-Malkajiri (Dt)-501301  
Telangana State





**PRINCIPAL**  
Vignans Institute of Management & Technology For Women  
Kondapur (V), Ghatkesar (M), Medchal-Malkajiri (Dt)-501301  
Telangana State



# VIGNAN'S INSTITUTE OF MANAGEMENT AND TECHNOLOGY FOR WOMEN

Sponsored by Lavu Educational Society, Approved by AICTE, New Delhi & Affiliated to JNTUH, Hyderabad.  
Kondapur (V), Ghatkesar (M), Medchal - Malkajgiri (Dt) - 501 301 TS INDIA  
Phone: +08615 200006/07/08 Email: info@vmtw.in

## INTERNAL QUALITY ASSURANCE CELL

### ACADEMIC & ADMINISTRATIVE AUDIT REPORT

#### Evaluation Sheet

Department Name : **Electronics and Communication Engineering**  
Programme Name : **B. Tech**  
Academic Year : **2018-19**

<b>I. PSOs, POs and Curriculum</b>		
<b>S.No</b>	<b>Parameter</b>	<b>Observations</b>
1.	PSO's and POs attainment.	Attainments Calculated File Available.
2.	DAC meetings	PAC meeting was conducted on : 06-07-2018 DAC meeting was conducted on:07/07/2018 DAC meeting was conducted on:08/12/2018  Files are available in the department.
3.	Stakeholder's feedback and evidence related to curriculum design.	Feedbacks collected. Analysis Done. Available in files.
4.	Percentage of lab component	Percentage of Lab Component Based on number of Subjects:48.27 Based on number of Credits:20.58 Based on number of Contact Hours:54.54



  
PRINCIPAL

Vignan's Institute of Management & Technology For Women  
Kondapur (V), Ghatkesar (M), Medchal-Malkajgiri (Dt)-501301  
Telangana State



# VIGNAN'S INSTITUTE OF MANAGEMENT AND TECHNOLOGY FOR WOMEN

Sponsored by Lavu Educational Society, Approved by AICTE, New Delhi & Affiliated to JNTUH, Hyderabad.  
Kondapur (V), Ghatkesar (M), Medchal - Malkajiri (D) - 501 301 TS INDIA  
Phone: +08615 20006/07/08 Email: info@vmtw.in

## II. Faculty information and their contribution

S. No	Parameter	Observations
1.	Teacher- Student ratio	(269/19)=14.16
2.	Faculty Cadre Ratio	Professors : 1 Associate Professors: 2 Assistant Professors: 13
3.	Faculty Qualifications	Ph.D's:4 Pursuing Ph.D:-2 All the other faculty have M.Tech /M.E/-15
4.	Faculty contribution in writing:	NIL
5.	Awards/Rewards received:	NIL
6.	Faculty in professional organizations: And faculty contribution:	IETE : 1 ORCID:1
7.	National level events organized -Conferences: -Workshops/ Seminars: -FDPs: International level events organized -Conferences: -Workshops/Seminars:	EVENTS ORGANISED FDP: NIL WORKSHOPS : NIL SEMINARS: 5
8.	List of Conferences/seminars/ workshops / FDP's/ any exclusive programs attended for enrichment of teaching - learning process.	FDP:4 WORKSHOP : 4 CONFERENCES: NIL
9.	Faculty interaction with outside world (BOS/NBA/Examiner for PhD evaluation / selection committee / Academic auditing	NIL



  
PRINCIPAL  
Vignans Institute of Management & Technology For Women  
Kondapur (V), Ghatkesar (M), Medchal-Malkajiri (Dt)-501301  
Telangana State



# VIGNAN'S INSTITUTE OF MANAGEMENT AND TECHNOLOGY FOR WOMEN

Sponsored by Lavu Educational Society, Approved by AICTE, New Delhi & Affiliated to JNTUH, Hyderabad.  
Kondapur (V), Ghatkesar (M), Medchal - Malkajgiri (D) - 501 301 TS INDIA  
Phone: +08615 200006/07/08 Email: info@vmtw.in

10.	Faculty Load	Faculty load is distributed as per AICTE Norms. Details are made available in Work Load Particular file.
-----	--------------	---

### III. Teaching-Learning Process and Evaluation

S. No	Parameter	Observations
1.	Student performance indices Attendance ,Exams	No. of Students Detained: II-I:1 III-II:1 IV-II-2 Result Analysis : (PASS PERCENTAGE): II-I : 57.84 II-II :58.82 III-I:42.86 III-II:74.70 IV-I:55.70 IV-II-92.21
2.	Mechanism and activities for slow learners for their improvement and outcomes	Slow Learners are identified based on their performance in their Mid-Examinations. Remedial classes were conducted. Details are available in Remedial file in the Department.
3.	Student counseling/ mentoring mechanism	Every faculty(mentor) is assigned to 20 students. All the II,III,IV B.Tech students are assigned to a mentor. Mentor Book is maintained for every student. Mentoring related files is available in the department.
4.	Tutorial classes	Tutorial classes are included in the regular timetable. Classes were conducted as per the schedule. Tutorial classes related details are maintained in a separate file.
5.	Initiatives taken for innovative mini and major projects -Training for students & faculty	Guest Lectures and Workshops are organized on Latest Technologies.
6.	Best student projects with awards.	2 Projects were identified. Details are maintained in Project file.





PRINCIPAL

Vignans Institute of Management & Technology For Women  
Kondapur (V), Ghatkesar (M), Medchal-Malkajgiri (Dt)-501301  
Telangana State





# VIGNAN'S INSTITUTE OF MANAGEMENT AND TECHNOLOGY FOR WOMEN

Sponsored by Lavu Educational Society, Approved by AICTE, New Delhi & Affiliated to JNTUH, Hyderabad.

Kondapur (V), Ghatkesar (M), Medchal - Malkajgiri (D) - 501 301 TS INDIA

Phone: +08615 200006/07/08

Email: info@vmtw.in

7.	Monitoring of teaching--learning process -- Assessment of teaching process in Classrooms. -- Random verification of evaluated answer papers and question paper during the semester. -- Innovative teaching methods presented if any -- Verification of course files	<ol style="list-style-type: none"><li>1. Lecture Plans submitted by all the subject faculty is monitored by HOD regularly.</li><li>2. Department have a exam committee to evaluate Mid-Exam Question Paper.</li><li>3. All the Question Papers are prepared following Bloom's Taxonomy.</li><li>4. Few faculty used ICT tools to deliver lectures.</li><li>5. Course file were verified by HOD and Department IQAC Co-ordinator. Suggestions were given to the concerned faculty.</li></ol>
8.	Training programs conducted for students Guest lecturers: Seminars/ workshops:	Training programs Workshops -1 Seminars/ Guest lectures -1
9.	Students feedback	Student Feedbacks were collected on all the subjects.
10.	Feedback follow-up action	Collected feedback is analyzed. Follow-Up Actions were initiated based on the students feedback. Details are maintained in Feedback File.
11.	Scope for Self-learning Certificate courses Online courses	<b>NIL</b>
12.	Placements (%): Industries / Organizations:	No. of Students:77 No. of Students Placed : 63 Details are maintained in Placement file
13.	Higher studies (%): Institutions:	Students Higher studies: 3 Total No. of Institutions :3 Details are maintained in higher education file.



  
PRINCIPAL

Vignan's Institute of Management & Technology For Women  
Kondapur (V), Ghatkesar (M), Medchal-Malkajgiri (Dt)-501301  
Telangana State



# VIGNAN'S INSTITUTE OF MANAGEMENT AND TECHNOLOGY FOR WOMEN

Sponsored by Lavu Educational Society, Approved by AICTE, New Delhi & Affiliated to JNTUH, Hyderabad.  
Kondapur (V), Ghatkesar (M), Medchal - Malkajgiri (D) - 501 301 TS INDIA  
Phone: +08615 200006/07/08 Email: info@vmtw.in

## IV. Research, Consultancy and Extension

Sl.No	Parameter	Observations
1.	Faculty publications in journals: Peer reviewed Journals:	International Journals : 5 National Journals : NIL Scopus Indexed : 0 SCI Indexed : 0 <b>Details are also Maintained in separate file-Publication File</b>
2.	Publications in conferences: - National: - International:	National : 0 International : 1 <b>Details are also Maintained in separate file-Publication File</b>
3.	PhDs -Registered: Submitted: Awarded: PhDs guiding /guided:	PhDs -Registered : 0 Submitted : 0 Awarded : 0 PhDs guiding /guided: NIL
4.	Funded R&D projects and Consultancy work Applied: Ongoing: Completed:	Applied : 2 Ongoing :NIL Completed :2
5.	Faculty intellectual property rights	IPR : 3 Patents.
6.	MOU's with industries/ R&D/ Premier institutes	MOU's with Industries : 2 R&D : 1 Premier Institutes : NIL
7.	Research centers of excellence established: Outcome in research centers:	NIL
8.	Faculty involved in research and Consultancy.	Number of faculty involved in research and Consultancy : 2



  
PRINCIPAL

Vignans Institute of Management & Technology For Women  
Kondapur (V), Ghatkesar (M), Medchal-Malkajgiri (Dt)-501301  
Telangana State



# VIGNAN'S INSTITUTE OF MANAGEMENT AND TECHNOLOGY FOR WOMEN

Sponsored by Lavu Educational Society, Approved by AICTE, New Delhi & Affiliated to JNTUH, Hyderabad.

Kondapur (V), Ghatkesar (M), Medchal - Malkajgiri (Dt) - 501 301 TS INDIA

Phone: +08615 200006/07/08

Email: info@vmtw.in

## V. Infrastructure and Learning Resources

Sl. No	Parameter	Observations
1.	Adequacy of infrastructural facilities to improve the teaching learning process Class rooms: Laboratories: ICT class rooms / e- Class Rooms: Seminar halls: Faculty rooms:	Class rooms : 6 Laboratories : 12 E-Class room : 1 Seminar halls : 1 Faculty Rooms : 1
2.	Internet facilities for faculty & Students:	1. Wi-Fi facility also provided to Staff and Students Laptops. 2. Internet facility provided to all computers in Laboratories. 3. Department Office and Staff rooms are having internet by LAN and Wi-Fi.
3.	Technical manpower support	Lab Assistant -7 Lab. Technician -1 Total manpower support - 8
4.	Modern / new equipment added in laboratories	30- New Components are added in EDC lab
5.	Details of computing facilities and Improvement.	Adequate facilities are available as needed.
6.	Department level library resources with Details.	Text books -110 Digital Library: Can access through LAN



PRINCIPAL

Vignani's Institute of Management & Technology For Women  
Kondapur (V), Ghatkesar (M), Medchal-Malkajgiri (Dt)-501301  
Telangana State



# VIGNAN'S INSTITUTE OF MANAGEMENT AND TECHNOLOGY FOR WOMEN

Sponsored by Lavu Educational Society, Approved by AICTE, New Delhi & Affiliated to JNTUH, Hyderabad.

Kondapur (V), Ghatkesar (M), Medchal - Malkajgiri (Dt) - 501 301 TS INDIA

Phone: +08615 200006/07/08

Email: info@vmtw.in

<b>VI. Student information, Support and Progression</b>		
<b>Sl. No</b>	<b>Parameter</b>	<b>Observations</b>
1.	Add-on courses:	Add-on Courses: 4 Details on Add-on Courses are maintained in a file.
2.	Student prizes: Scholarships	1. Student Prizes – 13 2. Scholarship – 0 Department student clubs – 3
3.	Details of coaching provided for GATE/GRE/any other Competitive Exams.	Company Specific CRT has been initiated for placements.
4.	Internships	Internships -32



PRINCIPAL

Vignans Institute of Management & Technology For Women  
Kondapur (V), Ghatkesar (M), Medchal-Malkajgiri (Dt)-501301  
Telangana State



# VIGNAN'S INSTITUTE OF MANAGEMENT AND TECHNOLOGY FOR WOMEN

Sponsored by Lavu Educational Society, Approved by AICTE, New Delhi & Affiliated to JNTUH, Hyderabad.  
Kondapur (V), Ghatkesar (M), Medchal - Malkajgiri (D) - 501 301 TS INDIA  
Phone: +08615 200006/07/08 Email: info@vmtw.in

VII. Governance, Leadership and Management		
Sl. No	Parameter	Observations
1.	Teaching and Non-Teaching staff attended for skill development programs	Teaching staff: 1 Non-teaching staff: 1 NPTEL online Certificate courses no of faculty certified:1
2.	MoUs with premier Institutions for knowledge exchange	1
3.	Quality policy & Quality objectives Committees & duties: Cells & duties:	Quality measures are taken care by IQAC of the institution.
4.	Maintenance factor -physical observation -Biometric -Attendance monitoring system	1. Attendance registers of faculty are maintained in the department. Principal counter-signs the registers everyday. 2. Biometric attendance is maintained for all the faculty. 2. Student's attendance is collected everyday and absentee's information is sent to their parents' mobile through SMS. 3. Attendance registers of the students (physical) is maintained and countersigned by HOD regularly. 4. The Students having less than 75% attendance information is maintained and informed to the parents periodically. <b>(Registers are maintained in Department office)</b>
5.	Financial support/leaves for qualification/skill up- gradation:	Financial assistance is given to the faculty as per the policy of the institution. File is available in Department.
6.	Risk evaluation/safety measures:	Safety measures are followed thoroughly.



*ASH*

PRINCIPAL

Vignans Institute of Management & Technology For Women  
Kondapur (V), Ghatkesar (M), Medchal-Malkajgiri (Dt)-501301  
Telangana State



# VIGNAN'S INSTITUTE OF MANAGEMENT AND TECHNOLOGY FOR WOMEN

Sponsored by Lavu Educational Society, Approved by AICTE, New Delhi & Affiliated to JNTUH, Hyderabad.  
Kondapur (V), Ghatkesar (M), Medchal - Malkajgiri (Dt) - 501 301 TS INDIA  
Phone: +08615 200006/07/08 Email: info@vmtw.in



Suggestions for improvement:

1. DST Projects to be applied.
2. Improvement needed in books and conference proceedings.
3. Enhance quality publications.
4. Collaborative initiatives to be improved

Sign of Department Coordinator:

  
J. Sriikumar

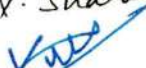
Sign of Academic Auditors

1.   
(S. Sudheer Kumar)
2.   
(K. Bharathi Reddy)
3.   
T. Dileep

Sign of HOD:



**Head of the Department**  
**Electronics and Communication Engineering**  
**Vignan's Institute of Management & Technology For Women**  
Kondapur (V), Ghatkesar (M), Medchal-Malkajgiri (Dt)-501301

Sign of IQAC Coordinator:

**Co-ordinator**  
**Internal Quality Assurance Cell**  
**Vignan's Institute of Management & Technology For Women**  
Kondapur (V), Ghatkesar (M), Medchal-Malkajgiri (Dt)-501301  
Telangana State



  
PRINCIPAL

Vignan's Institute of Management & Technology For Women  
Kondapur (V), Ghatkesar (M), Medchal-Malkajgiri (Dt)-501301  
Telangana State



# VIGNAN'S INSTITUTE OF MANAGEMENT AND TECHNOLOGY FOR WOMEN

Sponsored by Lavu Educational Society, Approved by AICTE, New Delhi & Affiliated to JNTUH, Hyderabad.  
Kondapur (V), Ghatkesar (M), Medchal - Malkajiri (D) - 501 301 TS INDIA  
Phone: +08615 200006/07/08 Email: info@vmtw.in

## INTERNAL QUALITY ASSURANCE CELL

### ACADEMIC & ADMINISTRATIVE AUDIT REPORT

#### Evaluation Sheet

Department Name : BSH  
Programme Name : B. Tech  
Academic Year : 2018-19

I. PSOs, POs and Curriculum		
S.No	Parameter	Observations
1.	PSO's and POs attainment.	Attainments Calculated File Available.
2.	DAC meetings	DAC meetings Dates: 1) 10-07-2018 2) 22-12-2018 File Available.
3.	Stakeholder's feedback and evidence related to curriculum design.	Feedbacks collected. Analysis Done. Available in files.
4.	Percentage of lab component	Percentage of Lab Component : Based on number of Subjects: 40% Based on number of Credits: 24.32% Based on number of Contact Hours : 38.63%



  
PRINCIPAL  
Vignans Institute of Management & Technology For Women  
Kondapur (V), Ghatkesar (M), Medchal-Malkajiri (Dt)-501301  
Telangana State



# VIGNAN'S INSTITUTE OF MANAGEMENT AND TECHNOLOGY FOR WOMEN

Sponsored by Lavu Educational Society, Approved by AICTE, New Delhi & Affiliated to JNTUH, Hyderabad.  
Kondapur (V), Ghatkesar (M), Medchal - Malkajiri (Dt) - 501 301 TS INDIA  
Phone: +08615 200006/07/08 Email: info@vmtw.in

II. Faculty information and their contribution		
S. No	Parameter	Observations
1.	Teacher- Student ratio	14.81
2.	Faculty Cadre Ratio	Professors : 1 Associate Professors: 2 Assistant Professors: 13
3.	Faculty Qualifications	Ph.D's: 1 Pursuing Ph.D: 01 All the faculty have M.Tech/M.E/ M.Sc/MBA :15
4.	Faculty contribution in writing:	NIL
5.	Awards/Rewards received:	NIL
6.	Faculty in professional organizations: And faculty contribution:	NIL
7.	National level events organized -Conferences: -Workshops/ Seminars: -FDPs: International level events organized -Conferences: -Workshops/Seminars:	NIL
8.	List of Conferences/seminars/ workshops / FDP's/ any exclusive programs attended for enrichment of teaching - learning process.	International Conferences: National Conference: 4 Workshops: 4 FDP's: 15 STTP: 5
9.	Faculty interaction with outside world (BOS/NBA/Examiner for PhD evaluation / selection committee / Academic auditing	NIL
10.	Faculty Load	Faculty load is distributed as per AICTE Norms. Details are made available in Work Load Particular file.



  
PRINCIPAL  
Vignans Institute of Management & Technology For Women  
Kondapur (V), Ghatkesar (M), Medchal-Malkajiri (Dt)-501301  
Telangana State





# VIGNAN'S INSTITUTE OF MANAGEMENT AND TECHNOLOGY FOR WOMEN

Sponsored by Lavu Educational Society, Approved by AICTE, New Delhi & Affiliated to JNTUH, Hyderabad.  
Kondapur (V), Ghatkesar (M), Medchal - Malkajgiri (D) - 501 301 TS INDIA  
Phone: +08615 200006/07/08 Email: info@vmtw.in

## III. Teaching-Learning Process and Evaluation

S. No	Parameter	Observations
1.	Student performance indices Attendance ,Exams	Students Detained in this Academic Year: I-I : 02 I-II : 05 Result Analysis: Pass Percentage I-I : 65.40% I-II : 61.70%
2.	Mechanism and activities for slow learners for their improvement and outcomes	Slow Learners are identified based on their performance in their Mid-Examinations. Remedial classes were conducted. Details are available in Remedial file in the Department.
3.	Student counseling/ mentoring mechanism	Every faculty(mentor) is assigned to 20 students. All the I B.Tech students are assigned to a mentor. Mentor Book is maintained for every student. Mentoring related files is available in the department.
4.	Tutorial classes	Tutorial classes are included in the regular timetable. Classes were conducted as per the schedule. Tutorial classes related details are maintained in a separate file.
5.	Initiatives taken for innovative mini and major projects -Training for students & faculty	NIL
6.	Best student projects with awards.	NA
7.	Monitoring of teaching--learning process -- Assessment of teaching process in Classrooms. -- Random verification of evaluated answer papers and question paper during the semester. -- Innovative teaching methods presented if any -- Verification of course files	1. Lecture Plans submitted by all the subject faculty is monitored by HOD regularly. 2. Department have a exam committee to evaluate Mid-Exam Question Paper. 3. All the Question Papers are prepared following Bloom's Taxonomy. 4.Few faculty used ICT tools to deliverlectures. 5. Course file were verified by HOD and Department IQAC Co-ordinator.Suggestions were given to the concerned faculty.



  
PRINCIPAL

Vignans Institute of Management & Technology For Women  
Kondapur (V), Ghatkesar (M), Medchal-Malkajgiri (Dt)-501301  
Telangana State



# VIGNAN'S INSTITUTE OF MANAGEMENT AND TECHNOLOGY FOR WOMEN

Sponsored by Lavu Educational Society, Approved by AICTE, New Delhi & Affiliated to JNTUH, Hyderabad.  
Kondapur (V), Ghatkesar (M), Medchal - Malkajgiri (Dt) - 501 301 TS INDIA  
Phone: +08615 200006/07/08 Email: info@vmtw.in

8.	Training programs conducted for students Guest lecturers: Seminars/ workshops:	Training programs Workshops -0 Seminars - 0 Guest lectures - 02
9.	Students feedback	Student Feedbacks were collected on all the subjects.
10.	Feedback follow-up action	Collected feedback is analyzed. Follow-Up Actions were initiated based on the students feedback. Details are maintained in Feedback File.
11.	Scope for Self-learning Certificate courses Online courses	NIL
12.	Placements (%): Industries / Organizations:	NA
13.	Higher studies (%): Institutions:	NA

## IV. Research, Consultancy and Extension

Sl.No	Parameter	Observations
1.	Faculty publications in journals: Peer reviewed Journals:	NIL
2.	Publications in conferences: - National: - International:	NIL
3.	PhDs -Registered: Submitted: Awarded: PhDs guiding /guided:	NIL
4.	Funded R&D projects and Consultancy work Applied: Ongoing: Completed:	NIL
5.	Faculty intellectual property rights	IPR : NIL



  
PRINCIPAL  
Vignan's Institute of Management & Technology For Women  
Kondapur (V), Ghatkesar (M), Medchal-Malkajgiri (Dt)-501301  
Telangana State



## VIGNAN'S INSTITUTE OF MANAGEMENT AND TECHNOLOGY FOR WOMEN

Sponsored by Lavu Educational Society, Approved by AICTE, New Delhi & Affiliated to JNTUH, Hyderabad.  
Kondapur (V), Ghatkesar (M), Medchal - Malkajgiri (Dt) - 501 301 TS INDIA  
Phone: +08615 200006/07/08 Email: info@vmtw.in

6.	R&D grants & projects and their outcomes.	R&D/Consultancy grants :NIL
7.	MOU's with industries/ R&D/ Premier institutes	NIL
8.	Research centers of excellence established: Outcome in research centers:	NIL
9.	Faculty involved in research and Consultancy.	Number of faculty involved in research and Consultancy : NIL



  
PRINCIPAL

Vignan's Institute of Management & Technology For Women  
Kondapur (V), Ghatkesar (M), Medchal-Malkajgiri (Dt)-501301  
Telangana State



# VIGNAN'S INSTITUTE OF MANAGEMENT AND TECHNOLOGY FOR WOMEN

Sponsored by Lavu Educational Society, Approved by AICTE, New Delhi & Affiliated to JNTUH, Hyderabad.  
Kondapur (V), Ghatkesar (M), Medchal - Malkajgiri (D) - 501 301 TS INDIA  
Phone. +08615 200006/07/08 Email. info@vmtw.in

## V. Infrastructure and Learning Resources

Sl. No	Parameter	Observations
1.	Adequacy of infrastructural facilities to improve the teaching learning process Class rooms: Laboratories: ICT class rooms / e- Class Rooms: Seminar halls: Faculty rooms:	Class rooms : 04 Laboratories : 05 E-Class room : 01 Seminar halls : 01 Faculty Rooms : 01
2.	Internet facilities for faculty & Students:	1. Wi-Fi facility also provided to Staff and Students Laptops. 2. Internet facility provided to all computers in Laboratories. 3. Department Office and Staff rooms are having internet by LAN and Wi-Fi.
3.	Technical manpower support	Lab. Technician - 05 Office Assistant - 01 Total manpower support - 06
4.	Modern / new equipment added in laboratories	Equipments related to Physics Lab were added : 05
5.	Details of computing facilities and Improvement.	Adequate facilities are available as needed.
6.	Department level library resources with Details.	Text books -- 50 <b>Digital Library: Can access in LAN</b> ( Details are maintained in College Website



  
PRINCIPAL  
Vignan's Institute of Management & Technology For Women  
Kondapur (V), Ghatkesar (M), Medchal-Malkajgiri (Dt)-501301  
Telangana State



# VIGNAN'S INSTITUTE OF MANAGEMENT AND TECHNOLOGY FOR WOMEN

Sponsored by Lavu Educational Society, Approved by AICTE, New Delhi & Affiliated to JNTUH, Hyderabad.

Kondapur (V), Ghatkesar (M), Medchal - Malkajgiri (Dt) - 501 301 TS INDIA

Phone: +08615 200006/07/08

Email: info@vmtw.in

## VI. Student information, Support and Progression

Sl. No	Parameter	Observations
1.	Induction Programs	Induction and Orientation programs were conducted for Newly joined 1 year students. Details are maintained in Separate File.
2.	Student prizes: Scholarships	1. Student Prizes – 13 2. Scholarships – 4
3.	Details of coaching provided for GATE/GRE/any other Competitive Exams.	NIL
4.	Internships	NIL



*ASH*

PRINCIPAL

Vignans Institute of Management & Technology For Women  
Kondapur (V), Ghatkesar (M), Medchal-Malkajgiri (Dt)-501301  
Telangana State



# VIGNAN'S INSTITUTE OF MANAGEMENT AND TECHNOLOGY FOR WOMEN

Sponsored by Lavu Educational Society, Approved by AICTE, New Delhi & Affiliated to JNTUH, Hyderabad.  
Kondapur (V), Ghatkesar (M), Medchal - Malkajiri (D) - 501 301 TS INDIA  
Phone: +08615 200006/07/08 Email: info@vmtw.in

## VII. Governance, Leadership and Management

Sl. No	Parameter	Observations
1.	Teaching and Non-Teaching staff attended for skill development programs	Teaching staff: 10 Non-teaching staff : 06 NPTEL online certificate courses Number of faculty Certified : Nil
2.	MoUs with premier Institutions for knowledge exchange	NIL
3.	Quality policy & Quality objectives Committees & duties: Cells & duties:	Quality measures are taken care by IQAC of the institution.
4.	Maintenance factor -physical observation -Biometric -Attendance monitoring system	1. Attendance registers of faculty are maintained in the department.Principal counter-signs the registers everyday. 2.Biometric attendance is maintained for all the faculty. 2. Student's attendance is collected everyday and absentee's information is sent to their parents mobile through SMS. 3. Attendance registers of the students (physical) is maintained and countersigned by HOD regularly. 4. The Students having less than 75% attendance information is maintained and informed to the parents periodically. <b>(Registers are maintained in Department office)</b>
5.	Financial support/leaves for qualification/skill up- gradation:	Financial assistance is given to the faculty as per the policy of the institution.
6.	Risk evaluation/safety measures:	Safety measures are followed thoroughly.



  
PRINCIPAL  
Vignan's Institute of Management & Technology For Women  
Kondapur (V), Ghatkesar (M), Medchal-Malkajiri (Dt)-501301  
Telangana State



# VIGNAN'S INSTITUTE OF MANAGEMENT AND TECHNOLOGY FOR WOMEN

Sponsored by Lavu Educational Society, Approved by AICTE, New Delhi & Affiliated to JNTUH, Hyderabad.  
Kondapur (V), Ghatkesar (M), Medchal - Malkajiri (Dt) - 501 301 TS INDIA  
Phone: +08615 200006/07/08 Email: info@vmtw.in



## 1. Suggestions for improvement:

1. More efforts to be taken to build research attitude among faculty.
2. Evaluation methods can be included with additional components.
3. ICT enabled teaching to be strengthened.
4. Publications to be improved.

Sign of Department Coordinator:

  
(Santosh Kumar K)

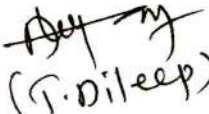
Sign of Academic Auditors 1.

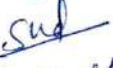
1.   
(T. Dilip)
2.   
K. Bhadravathi Reddy
3.   
(V. Sudheer Kumar)

Sign of HOD:

  
**Head of the Department**  
**Basic Sciences and Humanities**  
Vignans Institute of Management and Technology for Women  
Kondapur (V), Ghatkesar (M), R.F. Dist-501 301

Sign of IQAC Coordinator:

  
Co-ordinator  
Internal Quality Assurance Cell  
Vignans Institute of Management & Technology For Women  
Kondapur (V), Ghatkesar (M), Medchal-Malkajiri (Dt)-501301  
Telangana State



  
PRINCIPAL  
Vignans Institute of Management & Technology For Women  
Kondapur (V), Ghatkesar (M), Medchal-Malkajiri (Dt)-501301  
Telangana State



# VIGNAN'S INSTITUTE OF MANAGEMENT AND TECHNOLOGY FOR WOMEN

Sponsored by Lavu Educational Society, Approved by AICTE, New Delhi & Affiliated to JNTUH, Hyderabad.  
Kondapur (V), Ghatkesar (M), Medchal - Malkajgiri (D) - 501 301 TS INDIA  
Phone: +08615 200006/07/08 Email: info@vmtw.in

## INTERNAL QUALITY ASSURANCE CELL

### ACADEMIC & ADMINISTRATIVE AUDIT REPORT

#### Evaluation Sheet

Department Name : Computer Science and Engineering.

Programme Name : B. Tech

Academic Year : 2018-19

I. PSOs, POs and Curriculum		
S.No	Parameter	Observations
1.	PSO's and POs attainment.	Attainments Calculated File Available.
2.	PAC/DAC meetings	PAC meeting was conducted on : 22/05/2019 DAC meeting was conducted on: 07/05/2018 DAC meeting was conducted on: 14/09/2018
3.	Stakeholder's feedback and evidence related to curriculum design.	Feedbacks collected. Analysis Done. Available in files.
4.	Percentage of lab component	Percentage of Lab Component: Based on number of Subjects:48.27 Based on number of Credits:38.06 Based on number of Contact Hours:20.69



  
PRINCIPAL  
Vignan's Institute of Management & Technology For Women  
Kondapur (V), Ghatkesar (M), Medchal-Malkajgiri (Dt)-501301  
Telangana State





## VIGNAN'S INSTITUTE OF MANAGEMENT AND TECHNOLOGY FOR WOMEN

Sponsored by Lavu Educational Society, Approved by AICTE, New Delhi & Affiliated to JNTUH, Hyderabad.  
Kondapur (V), Ghatkesar (M), Medchal - Malkajgiri (D) - 501 301 TS INDIA  
Phone: +08615 200006/07/08 Email: info@vmtw.in

II. Faculty information and their contribution		
S. No	Parameter	Observations
1.	Teacher- Student ratio	12.5
2.	Faculty Cadre Ratio	Professors : 3 Associate Professors: 3 Assistant Professors:18
3.	Faculty Qualifications	Ph.D's: 3 Pursuing Ph.D:- All the other faculty have M.Tech /M.E/
4.	Faculty contribution in writing:	1
5.	Awards/Rewards received:	NIL
6.	Faculty in professional organizations: And faculty contribution:	IETE: 1 ISTE: 1 IEI: NIL SDIWC: NIL IAENG: NIL
7.	National level events organized -Conferences: -Workshops/ Seminars: -FDPs: International level events organized -Conferences: -Workshops/Seminars:	<b>EVENTS ORGANISED</b> FDP: 00 WORKSHOPS :06 SEMINARS: 03
8.	List of Conferences/seminars/ workshops / FDP's/ any exclusive programs attended for enrichment of teaching - learning process.	International Conferences:2 National Conference: Workshops: 15 FDP's: NIL STTP: NIL
9.	Faculty interaction with outside world (BOS/NBA/Examiner for PhD evaluation / selection committee / Academic auditing	NIL
10.	Faculty Load	Faculty load is distributed as per AICTE Norms. Details are made available in Work Load Particular file.



  
PRINCIPAL  
Vignans Institute of Management & Technology For Women  
Kondapur (V), Ghatkesar (M), Medchal-Malkajgiri (Dt)-501301  
Telangana State



# VIGNAN'S INSTITUTE OF MANAGEMENT AND TECHNOLOGY FOR WOMEN

Sponsored by Lavu Educational Society, Approved by AICTE, New Delhi & Affiliated to JNTUH, Hyderabad.  
Kondapur (V), Ghatkesar (M), Medchal - Malkajgiri (D) - 501 301 TS INDIA  
Phone: +08615 200006/07/08 Email: info@vmtw.in

## III. Teaching-Learning Process and Evaluation

S. No	Parameter	Observations
1.	Student performance indices Attendance ,Exams	Detained List: NIL Result Analysis : (PASS PERCENTAGE): II-I : 45.92 II-II :74.12 III-I:57.80 III-II:71.67 IV-I:74.19 IV-II-89.25
2.	Mechanism and activities for slow learners for their improvement and outcomes	Slow Learners are identified based on their performance in their Mid-Examinations. Remedial classes were conducted. Details are available in Remedial file in the Department.
3.	Student counseling/ mentoring mechanism	Every faculty(mentor) is assigned to 20 students. All the II,III,IV B.Tech students are assigned to a mentor. Mentor Book is maintained for every student. Mentoring related files is available in the department.
4.	Tutorial classes	Tutorial classes are included in the regular timetable. Classes were conducted as per the schedule. Tutorial classes related details are maintained in a separate file.
5.	Initiatives taken for innovative mini and major projects -Training for students & faculty	Guest Lectures and Workshops are organized on Latest Technologies.
6.	Best student projects with awards.	2 Projects were identified. Details are maintained in Project file.





PRINCIPAL

Vignans Institute of Management & Technology For Women  
Kondapur (V), Ghatkesar (M), Medchal-Malkajgiri (Dt)-501301  
Telangana State



# VIGNAN'S INSTITUTE OF MANAGEMENT AND TECHNOLOGY FOR WOMEN

Sponsored by Lavu Educational Society, Approved by AICTE, New Delhi & Affiliated to JNTUH, Hyderabad.  
Kondapur (V), Ghatkesar (M), Medchal - Malkajgiri (D) - 501 301 TS INDIA  
Phone: +08615 200006/07/08 Email: info@vmtw.in

7.	Monitoring of teaching--learning process -- Assessment of teaching process in Classrooms. -- Random verification of evaluated answer papers and question paper during the semester. -- Innovative teaching methods presented if any -- Verification of course files	1. Lecture Plans submitted by all the subject faculty is monitored by HOD regularly. 2. Department have a exam committee to evaluate Mid-Exam Question Paper. 3. All the Question Papers are prepared following Bloom's Taxonomy. 4. Few faculty used ICT tools to deliver lectures. 5. Course file were verified by HOD and Department IQAC Co-ordinator. Suggestions were given to the concerned faculty.
8.	Training programs conducted for students Guest lecturers: Seminars/ workshops:	Training programs - 07 Workshops - 06 Seminars/ Guest lectures - 01
9.	Students feedback	Student Feedbacks were collected on all the subjects.
10.	Feedback follow-up action	Collected feedback is analyzed. Follow-Up Actions were initiated based on the students feedback. Details are maintained in Feedback File.
11.	Scope for Self-learning Certificate courses Online courses	NPTEL No. of faculty Certified : 03 No. of Students Certified : NIL
12.	Placements (%): Industries / Organizations:	No. of Students: 93 No. of Students Placed : 57 Details are maintained in Placement file
13.	Higher studies (%): Institutions:	Students Higher studies: 3 Total No. of Institutions : 1 Details are maintained in higher education



PRINCIPAL

Vignans Institute of Management & Technology For Women  
Kondapur (V), Ghatkesar (M), Medchal-Malkajgiri (Dt)-501301  
Telangana State



## VIGNAN'S INSTITUTE OF MANAGEMENT AND TECHNOLOGY FOR WOMEN

Sponsored by Lavu Educational Society, Approved by AICTE, New Delhi & Affiliated to JNTUH, Hyderabad.  
Kondapur (V), Ghatkesar (M), Medchal - Malkajgiri (Dt) - 501 301 TS INDIA  
Phone: +08615 200006/07/08 Email: info@vmtw.in

### IV. Research, Consultancy and Extension

Sl.No	Parameter	Observations
1.	Faculty publications in journals: Peer reviewed Journals:	International Journals : 1 National Journals : NIL Scopus Indexed : 0 SCI Indexed : 0 <b>Details are also Maintained in separate file-Publication File</b>
2.	Publications in conferences: - National: - International:	National : 0 International : 1 <b>Details are also Maintained in separate file-Publication File</b>
3.	PhDs -Registered: Submitted: Awarded: PhDs guiding /guided:	PhDs -Registered : 01 Submitted : NIL Awarded : NIL
4.	Funded R&D projects and Consultancy work Applied: Ongoing: Completed:	Applied : 04 Ongoing : NIL Completed : 04 PhDs guiding /guided: NIL
5.	Faculty intellectual property rights	IPR : NIL
6.	R&D grants & projects and their outcomes.	04
7.	MOU's with industries/ R&D/ Premier institutes	MOU's with Industries : 05 R&D : NIL Premier Institutes : NIL
8.	Research centers of excellence established: Outcome in research centers:	NIL
9.	Faculty involved in research and Consultancy.	Number of faculty involved in research and Consultancy : 02



  
PRINCIPAL

Vignan's Institute of Management & Technology For Women  
Kondapur (V), Ghatkesar (M), Medchal-Malkajgiri (Dt)-501301  
Telangana State



# VIGNAN'S INSTITUTE OF MANAGEMENT AND TECHNOLOGY FOR WOMEN

Sponsored by Lavu Educational Society, Approved by AICTE, New Delhi & Affiliated to JNTUH, Hyderabad.  
Kondapur (V), Ghatkesar (M), Medchal - Malkajiri (D) - 501 301 TS INDIA  
Phone: +08615 200006/07/08 Email: info@vmtw.in

V. Infrastructure and Learning Resources		
Sl. No	Parameter	Observations
1.	Adequacy of infrastructural facilities to improve the teaching learning process Class rooms: Laboratories: ICT class rooms / e- Class Rooms: Seminar halls: Faculty rooms:	Class rooms : 06 Laboratories : 05 E-Class room : 03 Seminar halls : 01 Faculty Rooms : 01
2.	Internet facilities for faculty & Students:	1. Wi-Fi facility also provided to Staff and Students Laptops. 2. Internet facility provided to all computers in Laboratories. 3. Department Office and Staff rooms are having internet by LAN and Wi-Fi.
3.	Technical manpower support	Programmer - 06 Hardware Mechanic - NIL Lab. Technician - 02 Office .Assistant - NIL Training Assistant - NIL Total manpower support - 08
4.	Modern / new equipment added in laboratories	30- i3 processor computers were added.
5.	Details of computing facilities and Improvement.	Adequate facilities are available as needed.
6.	Department level library resources with Details.	Text books :154 Digital Library: Can access through LAN



  
PRINCIPAL  
Vignan's Institute of Management & Technology For Women  
Kondapur (V), Ghatkesar (M), Medchal-Malkajiri (Dt)-501301  
Telangana State



# VIGNAN'S INSTITUTE OF MANAGEMENT AND TECHNOLOGY FOR WOMEN

Sponsored by Lavu Educational Society, Approved by AICTE, New Delhi & Affiliated to JNTUH, Hyderabad.  
Kondapur (V), Ghatkesar (M), Medchal - Malkajgiri (Dt) - 501 301 TS INDIA  
Phone: +08615 200006/07/08 Email: info@vmtw.in

VI. Student information, Support and Progression		
Sl. No	Parameter	Observations
1.	Add-on courses:	Add-on Courses: 06  Details on Add-on Courses are maintained in a file..
2.	Student prizes: Scholarships	1. Student Prizes - 16 2. Scholarship - 0  Department student clubs - 2
3.	Details of coaching provided for GATE/GRE/any other Competitive Exams.	Company Specific CRT has been initiated for placements.
4.	Internships	Internships - 14



  
PRINCIPAL  
Vignans Institute of Management & Technology For Women  
Kondapur (V), Ghatkesar (M), Medchal-Malkajgiri (Dt)-501301  
Telangana State



# VIGNAN'S INSTITUTE OF MANAGEMENT AND TECHNOLOGY FOR WOMEN

Sponsored by Lavu Educational Society, Approved by AICTE, New Delhi & Affiliated to JNTUH, Hyderabad.  
Kondapur (V), Ghatkesar (M), Medchal - Malkajgiri (Dt) - 501 301 TS INDIA  
Phone: +08615 200006/07/08 Email: info@vmtw.in

## VII. Governance, Leadership and Management

Sl. No	Parameter	Observations
1.	Teaching and Non-Teaching staff attended for skill development programs	Teaching staff: 24 Non-teaching staff: 08
2.	MoUs with premier Institutions for knowledge exchange	NIL
3.	Quality policy & Quality objectives Committees & duties: Cells & duties:	Quality measures are taken care by IQAC of the institution.
4.	Maintenance factor -physical observation -Biometric -Attendance monitoring system	1. Attendance registers of faculty are maintained in the department. Principal counter-signs the registers everyday. 2. Biometric attendance is maintained for all the faculty. 3. Student's attendance is collected everyday and absentee's information is sent to their parents mobile through SMS. 4. Attendance registers of the students (physical) is maintained and countersigned by HOD regularly. 5. The Students having less than 75% attendance information is maintained and informed to the parents periodically. <b>(Registers are maintained in Department office)</b>
5.	Financial support/leaves for qualification/skill up- gradation:	Financial assistance is given to the faculty as per the policy of the institution. File is available in Department.
6.	Risk evaluation/safety measures:	Safety measures are followed thoroughly.



  
PRINCIPAL  
Vignan's Institute of Management & Technology For Women  
Kondapur (V), Ghatkesar (M), Medchal-Malkajgiri (Dt)-501301  
Telangana State





# VIGNAN'S INSTITUTE OF MANAGEMENT AND TECHNOLOGY FOR WOMEN

Sponsored by Lavu Educational Society, Approved by AICTE, New Delhi & Affiliated to JNTUH, Hyderabad.  
Kondapur (V), Ghatkesar (M), Medchal - Malkajgiri (D) - 501 301 TS INDIA  
Phone: +08615 200006/07/08 Email: info@vmtw.in

Suggestions for improvement:

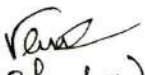
1. Research linkages with national and international institutions to be initiated.
2. Continuous evaluation process to be strengthened.
3. Improvement needed in books and conference proceedings.
4. Enhance quality publications.

Sign of Department Coordinator:   
(Vinay Bhushan)

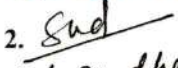
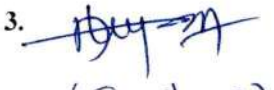
Sign of Academic Auditors 1.   
(K. Dharama Reddy)  
2.   
(V. Sudheer Kumar)  
3.   
(T. Dileep)

  
Sign of HOD: (V. Indrani)

  
Sign of IQAC Coordinator:

**Head of the Department**  
**Computer Science and Engineering**  
Vignan's Institute of Management and Technology for Women  
Kondapur (V), Ghatkesar (M), R.R. Dist-501 301.

**Co-ordinator**  
**Internal Quality Assurance Cell**  
Vignan's Institute of Management & Technology For Women  
Kondapur (V), Ghatkesar (M), Medchal-Malkajgiri (Dt)-501301  
Telangana State



  
**PRINCIPAL**  
Vignan's Institute of Management & Technology For Women  
Kondapur (V), Ghatkesar (M), Medchal-Malkajgiri (Dt)-501301  
Telangana State





**INTERNAL QUALITY ASSURANCE CELL**

**ACADEMIC & ADMINISTRATIVE AUDIT  
REPORT**

**Evaluation Sheet**

Department Name : **Computer Science and engineering.**

Programme Name : **B. Tech**

Academic Year : **2019-20**

<b>I. PSOs, POs and Curriculum</b>		
<b>S.No</b>	<b>Parameter</b>	<b>Observations</b>
1.	PSO's and POs attainment.	Calculations for Attainments are Completed. A file is maintained in the department.
2.	PAC/DAC meetings	DAC: 20/07/2019  PAC :17/08/2019 & 18/04/2019  Files are available in the department.
3.	Stakeholder's feedback and evidence related to curriculum design.	Feedbacks were collected and analysed. A file on stakeholder feedbacks is separately maintained.
4.	Percentage of lab component	Percentage of Lab Component Based on number of Subjects:53.57 Based on number of Credits:38.60 Based on number of Contact Hours:14.28





**PRINCIPAL**

Vignans Institute of Management & Technology For Women  
Kondapur (V), Ghatkesar (M), Medchal-Malkajgiri (Dt)-501301  
Telangana State



# VIGNAN'S INSTITUTE OF MANAGEMENT AND TECHNOLOGY FOR WOMEN

(Sponsored by Lavu Educational Society)

[Affiliated to JNTUH, Hyderabad & Approved by AICTE, New Delhi]

Kondapur (V), Ghatkesar (M), Medchal - Malkajgiri (D) - 501 301. Phone: 96529 10002/3



## II. Faculty information and their contribution

S. No	Parameter	Observations
1.	Teacher- Student ratio	11.43
2.	Faculty Cadre Ratio	Professors : 2 Associate Professors: 4 Assistant Professors: 22
3.	Faculty Qualifications	Ph.D's:3 Pursuing Ph.D: NIL All the other faculty have M.Tech /M.E/
4.	Faculty contribution in writing:	1
5.	Awards/Rewards received:	NIL
6.	Faculty in professional organizations: And faculty contribution:	IETE: 1 ISTE: 1 IEI: 1 SDIWC: NIL IAENG: 1
7.	National level events organized -Conferences: -Workshops/ Seminars: -FDPs: International level events organized -Conferences: -Workshops/Seminars:	EVENTS ORGANISED FDP: 03 WORKSHOPS : 06 SEMINARS: 02
8.	List of Conferences/seminars/ workshops / FDP's/ any exclusive programs attended for enrichment of teaching - learning process	International Conferences: NIL National Conference: NIL Workshops: 21 FDP's: NIL STTP:NIL



  
PRINCIPAL  
Vignan's Institute of Management & Technology For Women  
Kondapur (V), Ghatkesar (M), Medchal-Malkajgiri (Dt)-501301  
Telangana State



# VIGNAN'S INSTITUTE OF MANAGEMENT AND TECHNOLOGY FOR WOMEN

(Sponsored by Lavu Educational Society)

[Affiliated to JNTUH, Hyderabad & Approved by AICTE, New Delhi]

Kondapur (V), Ghatkesar (M), Medchal - Malkajgiri (D) - 501 301. Phone: 96529 10002/3



9.	Faculty interaction with outside world (BOS/NBA/Examiner for PhD evaluation / selection committee / Academic auditing /Chief guest /etc. )	NIL
10.	Faculty Load	Faculty load is distributed as per AICTE Norms.  HOD: 10 HOURS/WEEK PROFESSOR: 8-12 HOURS/WEEK ASSOC.PROF: 12-16 HOURS/WEEK ASSISTANT PROF.: 16-20 HOURS/WEEK Details are made available in Work Load Particular file.



PRINCIPAL

Vignans Institute of Management & Technology For Women  
Kondapur (V), Ghatkesar (M), Medchal-Malkajgiri (Dt)-501301  
Telangana State



### III. Teaching-Learning Process and Evaluation

S. No	Parameter	Observations
1.	Student performance indices Attendance ,Exams	Detained List: NIL Result Analysis : (PASS PERCENTAGE): II-I : 40.71 II-II :78.25 III-I: 65 III-II:66.67 IV-I: 56.07 IV-II : 87.62
2.	Mechanism and activities for slow learners for their improvement and outcomes	Remedial classes were conducted for slow learners based upon their performance in Mid-I examination. Details are Available in Remedial file
3.	Student counseling/ mentoring mechanism	One faculty mentor attached to 20 students from II,III,IV - B. Tech to look after the career, academic and personal problems. Mentor book is maintained for every student.
4.	Tutorial classes	Tutorials are conducted as per curriculum and sheets are available in faculty course files and in a separate file. Tutorial Hours also specified in regular Time Table.
5.	Initiatives taken for innovative mini and major projects -Training for students & faculty	Guest lectures and Workshops were conducted on various technologies.
6.	Best student projects with awards.	2 best projects were selected. Details are maintained in Project file.



*[Signature]*  
PRINCIPAL

Vignans Institute of Management & Technology For Women  
Kondapur (V), Ghatkesar (M), Medchal-Malkajgiri (Dt)-501301  
Telangana State



# VIGNAN'S INSTITUTE OF MANAGEMENT AND TECHNOLOGY FOR WOMEN

(Sponsored by Lavu Educational Society)

[Affiliated to JNTUH, Hyderabad & Approved by AICTE, New Delhi]

Kondapur (V), Ghatkesar (M), Medchal - Malkajgiri (D) - 501 301. Phone: 96529 10002/3



7.	Monitoring of teaching--learning process -- Assessment of teaching process in Classrooms. -- Random verification of evaluated answer papers and question paper during the semester. -- Innovative teaching methods presented if any -- Verification of course files	1. Lesson Plans were verified by HOD. 2. Student Attendance registers were checked by HOD in regular intervals. 3. Department committee assesses whether faculty are following the bloom's taxonomy and pattern of question papers as per regulations. 4. PPT's and video, used by faculty are mentioned in course files. 5. Course files are verified by HOD and Department IQAC Co-ordinator before finalizing the calculation of CO and PO attainments in every semester. Maintained in separate files- containing Lesson plans, Student performance, Course Question banks specified with COs , course materials & final assessment of all the students.
8.	Training programs conducted for students Guest lecturers: Seminars/ workshops:	Training programs - 13 Workshops - 06 Seminars/ Guest lectures - 02
9.	Students feedback	Feedbacks were taken for all the subjects in both the semesters.
10.	Feedback follow-up action	Feedbacks were analyzed. No follow-up action was initiated as the feedback taken from students was satisfactory.
11.	Scope for Self-learning Certificate courses Online courses	NPTEL No.of faculty Certified : 10 No.of Students Certified : 203
12.	Placements (%): Industries / Organizations:	No. of Students:105 No. of Students Placed : 75
13.	Higher studies (%): Institutions:	Students Higher studies: 7



  
PRINCIPAL  
Vignans Institute of Management & Technology For Women  
Kondapur (V), Ghatkesar (M), Medchal-Malkajgiri (Dt)-501301  
Telangana State



# VIGNAN'S INSTITUTE OF MANAGEMENT AND TECHNOLOGY FOR WOMEN

(Sponsored by Lavu Educational Society)

[Affiliated to JNTUH, Hyderabad & Approved by AICTE, New Delhi]

Kondapur (V), Ghatkesar (M), Medchal - Malkajgiri (D) - 501 301. Phone: 96529 10002/3



## IV. Research, Consultancy and Extension

Sl.No	Parameter	Observations
1.	Faculty publications in journals: Peer reviewed Journals:	International Journals : 5 National Journals : NIL Scopus Indexed : 4 OTHERS: 2 SCI Indexed : 0 Details are also Maintained in separate file-Publication File
2.	Publications in conferences: - National: - International:	National : 0 International : 1 Details are also Maintained in separate file-Publication File
3.	PhDs -Registered: Submitted: Awarded: PhDs guiding /guided:	PhDs -Registered : 02 Submitted : NIL Awarded : NIL PhDs guiding /guided: NIL
4.	Funded R&D projects and Consultancy work Applied: Ongoing: Completed:	Applied : 07 Ongoing : NIL Completed : 07
5.	Faculty intellectual property rights	IPR : 01 PATENT
6.	R&D grants & projects and their outcomes.	07
7.	MOU's with industries/ R&D/ Premier institutes	MOU's with Industries : 08 R&D : NIL Premier Institutes : NIL
8.	Research centers of excellence established: Outcome in research centers:	NIL
9.	Faculty involved in research and Consultancy.	Number of faculty involved in research and Consultancy :03



  
PRINCIPAL

Vignans Institute of Management & Technology For Women  
Kondapur (V), Ghatkesar (M), Medchal-Malkajgiri (D)-501301  
Telangana State



## V. Infrastructure and Learning Resources

Sl. No	Parameter	Observations
1.	Adequacy of infrastructural facilities to improve the teaching learning process Class rooms: Laboratories: ICT class rooms / e- Class Rooms: Seminar halls: Faculty rooms:	Class rooms : 06 Laboratories : 05 E-Class room : 03 Seminar halls : 01 Faculty Rooms : 01
2.	Internet facilities for faculty & Students:	1. Internet facility is provided throughout the campus for both Students and Staff. 2. All the computer labs are enabled with the internet facility.
3.	Technical manpower support	Programmer - 06 Hardware Mechanic - 01 Lab. Technician - 01 Office Assistant - 01 Training Assistant - NIL Total manpower support - 09
4.	Modern / new equipment added in laboratories	NIL
5.	Details of computing facilities and Improvement.	All the Labs are equipped with adequate facilities as needed.
6.	Department level library resources with Details.	Text books : 174 Digital Library: Can access through LAN



  
PRINCIPAL

Vignans Institute of Management & Technology For Women  
Kondapur (V), Ghatkesar (M), Medchal-Malkajgiri (Dt)-501301  
Telangana State



# VIGNAN'S INSTITUTE OF MANAGEMENT AND TECHNOLOGY FOR WOMEN

(Sponsored by Lavu Educational Society)

[Affiliated to JNTUH, Hyderabad & Approved by AICTE, New Delhi]

Kondapur (V), Ghatkesar (M), Medchal - Malkajgiri (D) - 501 301. Phone: 96529 10002/3



## VI. Student information, Support and Progression

Sl. No	Parameter	Observations
1.	Add-on Courses	Add-on Courses: 05  Details on Add-on Courses are maintained in a file.
2.	Student prizes: Scholarships Dept. Student clubs:	1. Student Prizes - 16 2. Scholarship - 3 3. Department student clubs - 2
3.	Details of coaching provided for GATE/GRE/any other Competitive Exams.	Company Specific CRT Training is provided for student Placements.
4.	Internships	Internships - 23



PRINCIPAL

Vignans Institute of Management & Technology For Women  
Kondapur (V), Ghatkesar (M), Medchal-Malkajgiri (Dt)-501301  
Telangana State





# VIGNAN'S INSTITUTE OF MANAGEMENT AND TECHNOLOGY FOR WOMEN

(Sponsored by Lavu Educational Society)

[Affiliated to JNTUH, Hyderabad & Approved by AICTE, New Delhi]

Kondapur (V), Ghatkesar (M), Medchal - Malkajiri (D) - 501 301. Phone: 96529 10002/3



## VII. Governance, Leadership and Management

Sl. No	Parameter	Observations
1.	Teaching and Non-Teaching staff attended for skill development programs	Teaching staff: 29 Non-teaching staff: 09
2.	MoUs with premier Institutions for knowledge exchange	02
3.	Quality policy & Quality objectives Committees & duties: Cells & duties:	Quality policy and Quality Objectives were directed by IQAC of the institution. All the measures monitored by IQAC.
4.	Maintenance factor -physical observation -Biometric -Attendance monitoring system	1. Student's attendance is monitored daily and absentee's information is sent to their parents through SMS. Monthly attendance percentage sent to their parents through letters by post 2. Attendance register is maintained for faculty in the department. It is countersigned by Principal daily 3. Attendance registers of the students (physical) is maintained and countersigned by HOD regularly. 4. The Students having less than 75% attendance information is maintained and informed to the parents periodically.
5.	Financial support/leaves for qualification/skill up- gradation:	Incentives were given to faculty as per the institute policy.
6.	Risk evaluation/safety measures:	Safety Measures are followed in all the laboratories.



PRINCIPAL

Vignan's Institute of Management & Technology For Women  
Kondapur (V), Ghatkesar (M), Medchal-Malkajiri (D)-501301  
Telangana State



# VIGNAN'S INSTITUTE OF MANAGEMENT AND TECHNOLOGY FOR WOMEN

(Sponsored by Lavu Educational Society)

[Affiliated to JNTUH, Hyderabad & Approved by AICTE, New Delhi]

Kondapur (V), Ghatkesar (M), Medchal - Malkajgiri (D) - 501 301. Phone: 96529 10002/3



## 1. Suggestions for improvement:

1. Motivate faculty in applying for DST Projects.
2. Encourage faculty to attend more FDP's and workshops.
3. Publications should be improved.

Sign of Department Coordinator:

*Meeera*  
(M. Vishnu Varaha)

Sign of Academic Auditors

1.

*J. Sanil Kumar*

J. Sanil Kumar

2.

*(Santhosh Kumar)*

(Santhosh Kumar)

3.

*(V. Sudheer Kumar)*

(V. Sudheer Kumar)

Sign of HOD :

*N. Indira*

**Head of the Department**  
**Computer Science and Engineering**  
Vignani's Institute of Management and Technology for Women  
Kondapur (V), Ghatkesar (M), R.R. Dist-501 301.

Sign of IQAC Coordinator:

*(Signature)*

**Co-ordinator**  
**Internal Quality Assurance Cell**  
Vignani's Institute of Management & Technology for Women  
Kondapur (V), Ghatkesar (M), Medchal-Malkajgiri Dist-501 301  
Telangana State



*(Signature)*

**PRINCIPAL**

Vignani's Institute of Management & Technology For Women  
Kondapur (V), Ghatkesar (M), Medchal-Malkajgiri (Dt)-501301  
Telangana State



**INTERNAL QUALITY ASSURANCE CELL**

**ACADEMIC & ADMINISTRATIVE AUDIT  
REPORT**

**Evaluation Sheet**

Department Name : **Electronics and Communication Engineering**

Programme Name : **B. Tech**

Academic Year : **2019-20**

<b>I. PSOs, POs and Curriculum</b>		
<b>S.No</b>	<b>Parameter</b>	<b>Observations</b>
1.	PSO's and POs attainment.	Calculations for Attainments are Completed. A file is maintained in the department.
2.	DAC meetings	PAC meeting was conducted on :06-07-2019 DAC meeting was conducted on:17/08/2019 DAC meeting was conducted on:05/12/2019  Files are available in the department.
3.	Stakeholder's feedback and evidence related to curriculum design.	Feedbacks were collected and analysed. A file on stakeholder feedbacks is separately maintained.
4.	Percentage of lab component	Percentage of Lab Component Based on number of Subjects:35.71 Based on number of Credits:18.69 Based on number of Contact Hours:40.00



  
PRINCIPAL

Vignans Institute of Management & Technology For Women  
Kondapur (V), Ghatkesar (M), Medchal-Malkajiri (Dt)-501301  
Telangana State



# VIGNAN'S INSTITUTE OF MANAGEMENT AND TECHNOLOGY FOR WOMEN

Sponsored by Lavu Educational Society, Approved by AICTE, New Delhi & Affiliated to JNTUH, Hyderabad.  
Kondapur (V), Ghatkesar (M), Medchal - Malkajgiri (D) - 501 301 Phone: +91 96529 10002/3



## II. Faculty information and their contribution

S. No	Parameter	Observations
1.	Teacher- Student ratio	(298/21)=14.19
2.	Faculty Cadre Ratio	Professors : 3 Associate Professors: 4 Assistant Professors: 14
3.	Faculty Qualifications	Ph.D's:3 Pursuing Ph.D:-4 All the other faculty have M.Tech /M.E/-18
4.	Faculty contribution in writing:	Books:NIL Book Chapters:NIL
5.	Awards/Rewards received:	NIL
6.	Faculty in professional organizations:  And faculty contribution:	IETE : 1 ISTE:1
7.	National level events organized -Conferences: -Workshops/ Seminars: -FDPs: International level events organized -Conferences: -Workshops/Seminars:	EVENTS ORGANISED FDP: 1 WORKSHOPS : NIL SEMINARS: 2



  
PRINCIPAL

Vignans Institute of Management & Technology For Women  
Kondapur (V), Ghatkesar (M), Medchal-Malkajgiri (Dt)-501301  
Telangana State



# VIGNAN'S INSTITUTE OF MANAGEMENT AND TECHNOLOGY FOR WOMEN

Sponsored by Lavu Educational Society, Approved by AICTE, New Delhi & Affiliated to JNTUH, Hyderabad.  
Kondapur (V), Ghatkesar (M), Medchal - Malkajgiri (D) - 501 301 Phone: +91 96529 10002/3



8.	List of Conferences/seminars/workshops / FDP's/ any exclusive programs attended for enrichment of teaching - learning process.	FDP:9 WORKSHOP : 4 CONFERENCES: NIL
9.	Faculty interaction with outside world (BOS/NBA/Examiner for PhD evaluation / selection committee / Academic auditing /Chief guest /etc. )	NIL
10.	Faculty Load	Faculty load is distributed as per AICTE Norms.  HOD: 10 HOURS/WEEK PROFESSOR: 8-12 HOURS/WEEK ASSOC.PROF: 12-16 HOURS/WEEK ASSISTANT PROF.: 16-20 HOURS/WEEK Details are made available in Work Load Particular file.



  
PRINCIPAL  
Vignans Institute of Management & Technology For Women  
Kondapur (V), Ghatkesar (M), Medchal-Malkajgiri (Dt)-501301  
Telangana State



### III. Teaching-Learning Process and Evaluation

S. No	Parameter	Observations
1.	Student performance indices Attendance ,Exams	Number of Students Detained II-II: 1 IV-II:1 Result Analysis : (PASS PERCENTAGE): II-I : 41.96 II-II :22.52 III-I: 65:00 III-II:26.73 IV-I: 59.04 IV-II:91.57
2.	Mechanism and activities for slow learners for their improvement and outcomes	Remedial classes were conducted for slow learners based upon their performance in Mid-I examination. Details are Available in Remedial file
3.	Student counseling/ mentoring mechanism	One faculty mentor attached to 20 students from II,III,IV - B. Tech to look after the career, academic and personal problems. Mentor book is maintained for every student.
4.	Tutorial classes	Tutorials are conducted as per curriculum and sheets are available in faculty course files and in a separate file. Tutorial Hours also specified in regular Time Table.
5.	Initiatives taken for innovative mini and major projects -Training for students & faculty	Guest lectures and Workshops were conducted on various technologies.
6.	Best student projects with awards.	2 best projects were selected. Details are maintained in Project file.



  
PRINCIPAL

Vignans Institute of Management & Technology For Women  
Kondapur (V), Ghatkesar (M), Medchal-Malkajgiri (Dt)-501301  
Telangana State



# VIGNAN'S INSTITUTE OF MANAGEMENT AND TECHNOLOGY FOR WOMEN

Sponsored by Lavu Educational Society, Approved by AICTE, New Delhi & Affiliated to JNTUH, Hyderabad.  
Kondapur (V), Ghatkesar (M), Medchal - Malkajgiri (D) - 501 301 Phone: +91 96529 10002/3



7.	Monitoring of teaching--learning process -- Assessment of teaching process in Classrooms. -- Random verification of evaluated answer papers and question paper during the semester. -- Innovative teaching methods presented if any -- Verification of course files	1. Lesson Plans were verified by HOD. 2. Student Attendance registers were checked by HOD in regular intervals. 3. Department committee assesses whether faculty are following the bloom's taxonomy and pattern of question papers as per regulations. 4. PPT's and video,used by faculty are mentioned in course files. 5. Course files are verified by HOD and Department IQAC Co-ordinator before finalizing the calculation of CO and PO attainments in every semester. Maintained in separate files- containing Lesson plans, Student performance, Course Question banks specified with COs , course materials & final assessment of all the students.
8.	Training programs conducted for students Guest lecturers: Seminars/ workshops:	Training programs Workshops -5 Seminars/ Guest lectures -5
9.	Students feedback	Feedbacks were taken for all the subjects in both the semesters.
10.	Feedback follow-up action	Feedbacks were analyzed. No follow-up action was initiated as the feedback taken from students was satisfactory.
11.	Scope for Self-learning Certificate courses Online courses	58
12.	Placements (%): Industries / Organizations:	No. of Students:83 No. of Students Placed : 71
13.	Higher studies (%): Institutions:	Students Higher studies: 4 Total No. of Institutions :2



PRINCIPAL

Vignans Institute of Management & Technology For Women  
Kondapur (V), Ghatkesar (M), Medchal-Malkajgiri (Dt)-501301  
Telangana State



# VIGNAN'S INSTITUTE OF MANAGEMENT AND TECHNOLOGY FOR WOMEN

Sponsored by Lavu Educational Society, Approved by AICTE, New Delhi & Affiliated to JNTUH, Hyderabad.  
Kondapur (V), Ghatkesar (M), Medchal - Malkajgiri (D) - 501 301 Phone: +91 96529 10002/3



## IV. Research, Consultancy and Extension

Sl.No	Parameter	Observations
1.	Faculty publications in journals: Peer reviewed Journals:	International Journals : 7 National Journals : NIL Scopus Indexed : 5 SCI Indexed : 0 Details are also Maintained in separate file- Publication File
2.	Publications in conferences: - National: - International:	National : 0 International : 2 Details are also Maintained in separate file- Publication File
3.	PhDs -Registered: Submitted: Awarded: PhDs guiding /guided:	PhDs -Registered : 2 Submitted : 0 Awarded : 0 PhDs guiding /guided: NIL
4.	Funded R&D projects and Consultancy work Applied: Ongoing: Completed:	Applied : 1 Ongoing : NIL Completed : 1
5.	Faculty intellectual property rights	NIL
6.	MOU's with industries/ R&D/ Premier institutes	MOU's with Industries : 2 R&D : NIL Premier Institutes : NIL
7.	Research centers of excellence established: Outcome in research centers:	NIL
8.	Faculty involved in research and Consultancy.	Number of faculty involved in research and Consultancy :1



PRINCIPAL

Vignans Institute of Management & Technology For Women  
Kondapur (V), Ghatkesar (M), Medchal-Malkajgiri (Dt)-501301  
Telangana State





# VIGNAN'S INSTITUTE OF MANAGEMENT AND TECHNOLOGY FOR WOMEN

Sponsored by Lavu Educational Society, Approved by AICTE, New Delhi & Affiliated to JNTUH, Hyderabad.  
Kondapur (V), Ghatkesar (M), Medchal - Malkajgiri (D) - 501 301 Phone: +91 96529 10002/3



## V. Infrastructure and Learning Resources

Sl. No	Parameter	Observations
1.	Adequacy of infrastructural facilities to improve the teaching learning process Class rooms: Laboratories: ICT class rooms / e- Class Rooms: Seminar halls: Faculty rooms:	Class rooms : 6 Laboratories : 10 E-Class room : 1 Seminar halls : 1 Faculty Rooms : 1
2.	Internet facilities for faculty & Students:	1. Internet facility is provided throughout the campus for both Students and Staff. 2. All the computer labs are enabled with the internet facility.
3.	Technical manpower support	Lab Assistant -7 Lab. Technician -1 Total manpower support - 8
4.	Modern / new equipment added in laboratories	4-Components are added in AC lab
5.	Details of computing facilities and Improvement.	All the Labs are equipped with adequate facilities as needed.
6.	Department level library resources with Details.	Text books -130 Digital Library: Can access through LAN



PRINCIPAL

Vignan's Institute of Management & Technology For Women  
Kondapur (V), Ghatkesar (M), Medchal-Malkajgiri (Dt)-501301  
Telangana State



# VIGNAN'S INSTITUTE OF MANAGEMENT AND TECHNOLOGY FOR WOMEN

Sponsored by Lavu Educational Society, Approved by AICTE, New Delhi & Affiliated to JNTUH, Hyderabad.  
Kondapur (V), Ghatkesar (M), Medchal - Malkajiri (D) - 501 301 Phone: +91 96529 10002/3



## VI. Student information, Support and Progression

Sl. No	Parameter	Observations
1.	Add-on Courses	Add-on Courses: 5 Details on Add-on Courses are maintained in a file.
2.	Student prizes: Scholarships Dept. Student clubs:	1. Student Prizes - 10 2. Scholarship - 0 3. Department student clubs - 3
3.	Details of coaching provided for GATE/GRE/any other Competitive Exams.	Company Specific CRT Training is provided for student Placements.
4.	Internships	Internships -38



PRINCIPAL

Vignans Institute of Management & Technology For Women  
Kondapur (V), Ghatkesar (M), Medchal-Malkajiri (Dt)-501301  
Telangana State



# VIGNAN'S INSTITUTE OF MANAGEMENT AND TECHNOLOGY FOR WOMEN

Sponsored by Lavu Educational Society, Approved by AICTE, New Delhi & Affiliated to JNTUH, Hyderabad.  
Kondapur (V), Ghatkesar (M), Medchal - Malkajgiri (D) - 501 301 Phone: +91 96529 10002/3



## VII. Governance, Leadership and Management

Sl. No	Parameter	Observations
1.	Teaching and Non-Teaching staff attended for skill development programs	Teaching staff: 1 Non-teaching staff: 1 NPTEL online Certificate courses no of faulty certified: NIL
2.	MoUs with premier Institutions for knowledge exchange	1
3.	Quality policy & Quality objectives Committees & duties: Cells & duties:	Quality policy and Quality Objectives were directed by IQAC of the institution. All the measures monitored by IQAC.
4.	Maintenance factor -physical observation -Biometric -Attendance monitoring system	1. Student's attendance is monitored daily and absentee's information is sent to their parents through SMS. Monthly attendance percentage sent to their parents through letters by post 2. Attendance register is maintained for faculty in the department. It is countersigned by Principal daily 3. Attendance registers of the students (physical) is maintained and countersigned by HOD regularly. 4. The Students having less than 75% attendance information is maintained and informed to the parents periodically.
5.	Financial support/leaves for qualification/skill up- gradation:	Incentives were given to faculty as per the institute policy.
6.	Risk evaluation/safety measures:	Safety Measures are followed in all the laboratories.



  
PRINCIPAL  
Vignans Institute of Management & Technology For Women  
Kondapur (V), Ghatkesar (M), Medchal-Malkajgiri (Dt)-501301  
Telangana State



# VIGNAN'S INSTITUTE OF MANAGEMENT AND TECHNOLOGY FOR WOMEN

Sponsored by Lavu Educational Society, Approved by AICTE, New Delhi & Affiliated to JNTUH, Hyderabad.  
Kondapur (V), Ghatkesar (M), Medchal - Malkajgiri (D) - 501 301 Phone: +91 96529 10002/3





## 1. Suggestions for improvement:

1. Encourage faculty to attend more FDP's and workshops.
2. Enhance modern teaching learning methods.
3. Publications should be improved.

Sign of Department Coordinator:   
(T. Pullaiah)

Sign of Academic Auditors

1.   
(CV. Sudheekumar)
2.   
(Saurthosh Kumar)
3.   
J. Sunilkumar

Sign of HOD: 

Head of the Department  
Electronics and Communication Engineering  
Vignan's Institute of Management & Technology For Women  
Kondapur (V), Ghatkesar (M), Medchal-Malkajgiri (Dt)-501301

Sign of IQAC Coordinator: 

Coordinator  
Internal Quality Assurance Cell  
Vignan's Institute of Management & Technology For Women  
Kondapur (V), Ghatkesar (M), Medchal-Malkajgiri (Dt)-501301  
Telangana State



  
PRINCIPAL  
Vignan's Institute of Management & Technology For Women  
Kondapur (V), Ghatkesar (M), Medchal-Malkajgiri (Dt)-501301  
Telangana State



**INTERNAL QUALITY ASSURANCE CELL**

**ACADEMIC & ADMINISTRATIVE AUDIT  
REPORT**

**Evaluation Sheet**

Department Name : BSH  
Programme Name : B. Tech  
Academic Year : 2019-20

<b>I. PSOs, POs and Curriculum</b>		
<b>S.No</b>	<b>Parameter</b>	<b>Observations</b>
1.	PSO's and POs attainment.	Calculations for Attainments are Completed. A file is maintained in the department.
2.	DAC meetings	DAC meetings were conducted on 02-08-2019 & 21-12-2019 Files are maintained in the department.
3.	Stakeholder's feedback and evidence related to curriculum design.	Feedbacks were collected and analysed. A file on stakeholder feedbacks is separately maintained.
4.	Percentage of lab component	Percentage of Lab Component : Based on number of Subjects: 40% Based on number of Credits:24.32% Based on number of Contact Hours :38.63%



*[Handwritten Signature]*

PRINCIPAL

Vignans Institute of Management & Technology For Women  
Kondapur (V), Ghatkesar (M), Medchal-Malkajgiri (Dt)-501301  
Telangana State



# VIGNAN'S INSTITUTE OF MANAGEMENT AND TECHNOLOGY FOR WOMEN

(Sponsored by Lavu Educational Society)

[Affiliated to JNTUH, Hyderabad & Approved by AICTE, New Delhi]

Kondapur (V), Ghatkesar (M), Medchal - Malkajgiri (D) - 501 301. Phone: 96529 10002/3



## II. Faculty information and their contribution

S. No	Parameter	Observations
1.	Teacher- Student ratio	14.94
2.	Faculty Cadre Ratio	Professors : 1 Associate Professors: 4 Assistant Professors: 13
3.	Faculty Qualifications	Ph.D's: 1 Pursuing Ph.D: 02 All the faculty have M.Tech/M.E/M.Sc./MBA/M.A.: 17
4.	Faculty contribution in writing:	NIL
5.	Awards/Rewards received:	NIL
6.	Faculty in professional organizations:  And faculty contribution:	NIL
7.	National level events organized -Conferences: -Workshops/ Seminars: -FDPs:  International level events organized -Conferences: -Workshops/Seminars:	NIL



PRINCIPAL

Vignans Institute of Management & Technology For Women  
Kondapur (V), Ghatkesar (M), Medchal-Malkajgiri (Dt)-501301  
Telangana State



# VIGNAN'S INSTITUTE OF MANAGEMENT AND TECHNOLOGY FOR WOMEN

(Sponsored by Lavu Educational Society)

[Affiliated to JNTUH, Hyderabad & Approved by AICTE, New Delhi]

Kondapur (V), Ghatkesar (M), Medchal - Malkajgiri (D) - 501 301. Phone: 96529 10002/3



8.	List of Conferences/seminars/workshops / FDP's/ any exclusive programs attended for enrichment of teaching - learning process	International Conferences: National Conference: Nil Workshops: 10 FDP's: 16
9.	Faculty interaction with outside world (BOS/NBA/Examiner for PhD evaluation / selection committee / Academic auditing /Chief guest /etc. )	NIL
10.	Faculty Load	Faculty load is distributed as per AICTE Norms.  HOD: 10 HOURS/WEEK PROFESSOR: 8-12 HOURS/WEEK ASSOC.PROF: 12-16 HOURS/WEEK ASSISTANT PROF.: 16-20 HOURS/WEEK Details are made available in Work Load Particular file.



  
PRINCIPAL

Vignan's Institute of Management & Technology For Women  
Kondapur (V), Ghatkesar (M), Medchal-Malkajgiri (Dt)-501301  
Telangana State



### III. Teaching-Learning Process and Evaluation

S. No	Parameter	Observations
1.	Student performance indices Attendance ,Exams	Detained List:  I-I : 06 I-II : 03  RESULT ANALYSIS: (PASS PERCENTAGE): I-I : 64.18% I-II : 44.19%
2.	Mechanism and activities for slow learners for their improvement and outcomes	Make up classes conducted for slow learners based upon their performance in Mid-I examination. (If the student get the <60% of marks in Mid Examination then we conducted Remedial classes.) <b>Details are Available in file</b>
3.	Student counseling/ mentoring mechanism	One faculty mentor attached to 20 students from I- B. Tech to look after the career, academic and personal problems. Mentor book is maintained for every student.
4.	Tutorial classes	Tutorials are conducted as per curriculum and sheets are available in <b>faculty course files and in a separate file.</b> <b>Tutorial Hours also specified in regular Time Table.</b>
5.	Initiatives taken for innovative mini and major projects -Training for students & faculty	NA
6.	Best student projects with awards.	NA



  
PRINCIPAL

Vignans Institute of Management & Technology For Women  
Kondapur (V), Ghatkesar (M), Medchal-Malkajgiri (Dt)-501301  
Telangana State





# VIGNAN'S INSTITUTE OF MANAGEMENT AND TECHNOLOGY FOR WOMEN

(Sponsored by Lavu Educational Society)

[Affiliated to JNTUH, Hyderabad & Approved by AICTE, New Delhi]

Kondapur (V), Ghatkesar (M), Medchal - Malkajgiri (D) - 501 301. Phone: 96529 10002/3



7.	Monitoring of teaching--learning process -- Assessment of teaching process in Classrooms. -- Random verification of evaluated answer papers and question paper during the semester. -- Innovative teaching methods presented if any -- Verification of course files	1. Lesson Plans were verified by HOD. 2. Student Attendance registers were checked by HOD in regular intervals. 3. Department committee assesses whether faculty are following the bloom's taxonomy and pattern of question papers as per regulations. 4. PPT's and video,used by faculty are mentioned in course files. 5. Course files are verified by HOD and Department IQAC Co-ordinator before finalizing the calculation of CO and PO attainments in every semester. Maintained in separate files- containing Lesson plans, Student performance, Course Question banks specified with COs , course materials & final assessment of all the students.
8.	Training programs conducted for students Guest lecturers: Seminars/ workshops:	Training programs - Workshops - Nil Seminars - Nil Guest lectures - 05
9.	Students feedback	<b>Feedbacks were taken for all the subjects in both the semesters.</b>
10.	Feedback follow-up action	<b>Feedbacks were analyzed. No follow-up action was initiated as the feedback taken from students was satisfactory.</b>
11.	Scope for Self-learning Certificate courses Online courses	<b>NIL</b>
12.	Placements (%): Industries / Organizations:	<b>NA</b>
13.	Higher studies (%): Institutions:	<b>NA</b>



  
PRINCIPAL  
Vignan's Institute of Management & Technology For Women  
Kondapur (V), Ghatkesar (M), Medchal-Malkajgiri (Dt)-501301  
Telangana State



# VIGNAN'S INSTITUTE OF MANAGEMENT AND TECHNOLOGY FOR WOMEN

(Sponsored by Lavu Educational Society)

[Affiliated to JNTUH, Hyderabad & Approved by AICTE, New Delhi]

Kondapur (V), Ghatkesar (M), Medchal - Malkajgiri (D) - 501 301. Phone: 96529 10002/3



## IV. Research, Consultancy and Extension

Sl.No	Parameter	Observations
1.	Faculty publications in journals: Peer reviewed Journals:	International Journals : Nil National Journals : 2 Scopus Indexed : 2 SCI Indexed : Nil <b>Details are also Maintained in separate file-Publication File</b>
2.	Publications in conferences: - National: - International:	NIL
3.	PhDs -Registered: Submitted: Awarded: PhDs guiding /guided:	NIL
4.	Funded R&D projects and Consultancy work Applied: Ongoing: Completed:	NIL
5.	Faculty intellectual property rights	NIL
6.	R&D grants & projects and their outcomes.	NIL
7.	MOU's with industries/ R&D/ Premier institutes	NIL
8.	Research centers of excellence established:  Outcome in research centers:	NIL
9.	Faculty involved in research and Consultancy.	Number of faculty involved in research and Consultancy :NIL



PRINCIPAL

Vignans Institute of Management & Technology For Women  
Kondapur (V), Ghatkesar (M), Medchal-Malkajgiri (Dt)-501301  
Telangana State



# VIGNAN'S INSTITUTE OF MANAGEMENT AND TECHNOLOGY FOR WOMEN

(Sponsored by Lavu Educational Society)

[Affiliated to JNTUH, Hyderabad & Approved by AICTE, New Delhi]

Kondapur (V), Ghatkesar (M), Medchal - Malkajgiri (D) - 501 301. Phone: 96529 10002/3



## V. Infrastructure and Learning Resources

Sl. No	Parameter	Observations
1.	Adequacy of infrastructural facilities to improve the teaching learning process Class rooms: Laboratories: ICT class rooms / e- Class Rooms: Seminar halls: Faculty rooms:	Class rooms : 05 Laboratories : 05 E-Class room : 01 Seminar halls : 01 Faculty Rooms : 01
2.	Internet facilities for faculty & Students:	1. Internet facility is provided throughout the campus for both Students and Staff. 2. All the computer labs are enabled with the internet facility.
3.	Technical manpower support	Lab. Technician - 05 Office Assistant - 01 <b>Total manpower support - 06</b>
4.	Modern / new equipment added in laboratories	<b>NIL</b>
5.	Details of computing facilities and Improvement.	All the Labs are equipped with adequate facilities as needed.
6.	Department level library resources with Details.	Text books --70



*[Signature]*  
PRINCIPAL

Vignans Institute of Management & Technology For Women  
Kondapur (V), Ghatkesar (M), Medchal-Malkajgiri (Dt)-501301  
Telangana State



# VIGNAN'S INSTITUTE OF MANAGEMENT AND TECHNOLOGY FOR WOMEN

(Sponsored by Lavu Educational Society)

[Affiliated to JNTUH, Hyderabad & Approved by AICTE, New Delhi]

Kondapur (V), Ghatkesar (M), Medchal - Malkajgiri (D) - 501 301. Phone: 96529 10002/3



## VI. Student information, Support and Progression

Sl. No	Parameter	Observations
1.	Induction Programs	Orientation and Induction programs were organized for newly joined students.
2.	Student prizes: Scholarships Dept. Student clubs:	1. Student Prizes -13 2. Scholarship - 10 3. Student Clubs -NIL
3.	Details of coaching provided for GATE/GRE/any other Competitive Exams.	NIL
4.	Internships	NIL



  
PRINCIPAL  
Vignans Institute of Management & Technology For Women  
Kondapur (V), Ghatkesar (M), Medchal-Malkajgiri (Dt)-501301  
Telangana State



# VIGNAN'S INSTITUTE OF MANAGEMENT AND TECHNOLOGY FOR WOMEN

(Sponsored by Lavu Educational Society)

[Affiliated to JNTUH, Hyderabad & Approved by AICTE, New Delhi]

Kondapur (V), Ghatkesar (M), Medchal - Malkajiri (D) - 501 301. Phone: 96529 10002/3



## VII. Governance, Leadership and Management

Sl. No	Parameter	Observations
1.	Teaching and Non-Teaching staff attended for skill development programs	Teaching staff: Nil Non-teaching staff: 06 NPTEL online certificate courses Number of faculty Certified : Nil
2.	MoUs with premier Institutions for knowledge exchange	NIL
3.	Quality policy & Quality objectives Committees & duties: Cells & duties:	Quality policy and Quality Objectives were directed by IQAC of the institution. All the measures monitored by IQAC.
4.	Maintenance factor -physical observation -Biometric -Attendance monitoring system	1. Student's attendance is monitored daily and absentee's information is sent to their parents through SMS. Monthly attendance percentage sent to their parents through letters by post 2. Attendance register is maintained for faculty in the department. It is countersigned by Principal daily 3. Attendance registers of the students (physical) is maintained and countersigned by HOD regularly. 4. The Students having less than 75% attendance information is maintained and informed to the parents periodically.
5.	Financial support/leaves for qualification/skill up- gradation:	Incentives were given to faculty as per the institute policy.
6.	Risk evaluation/safety measures:	Safety Measures are followed in all the laboratories.



  
PRINCIPAL

Vignans Institute of Management & Technology For Women  
Kondapur (V), Ghatkesar (M), Medchal-Malkajiri (Dt)-501301  
Telangana State



# VIGNAN'S INSTITUTE OF MANAGEMENT AND TECHNOLOGY FOR WOMEN

(Sponsored by Lavu Educational Society)

[Affiliated to JNTUH, Hyderabad & Approved by AICTE, New Delhi]

Kondapur (V), Ghatkesar (M), Medchal - Malkajgiri (D) - 501 301. Phone: 96529 10002/3



## 1. Suggestions for improvement:

1. Innovative Teaching Learning methods to be implemented.
2. Motivate faculty to attend more FDP's
3. Research Activities to be improved.

Sign of Department Coordinator:

*(Handwritten signature)*  
(T. Dilip)

Sign of Academic Auditors 1.

*(Handwritten signature)*  
(Santosh Kumar K)

2. *(Handwritten signature)*  
J-SriLakshmi

3. *(Handwritten signature)*  
(V. Sudheer Kumar)

Sign of HOD :

*(Handwritten signature)*

Head of the Department:  
**Basic Sciences and Humanities**  
Vignani's Institute of Management and Technology for Women  
Kondapur (V), Ghatkesar (M), R.R. Dist-501 301

Sign of IQAC Coordinator:

Co-ordinator  
Internal Quality Assurance Cell  
Vignani's Institute of Management & Technology For Women  
Kondapur (V), Ghatkesar (M), Medchal-Malkajgiri (Dt)-501301  
Telangana State



*(Handwritten signature)*

PRINCIPAL

Vignani's Institute of Management & Technology For Women  
Kondapur (V), Ghatkesar (M), Medchal-Malkajgiri (Dt)-501301  
Telangana State



**INTERNAL QUALITY ASSURANCE CELL**  
**ACADEMIC & ADMINISTRATIVE AUDIT REPORT**

**Evaluation Sheet**

Department Name : **Computer Science and Engineering**  
Programme Name : **B. Tech**  
Academic Year : **2020-21**

<b>I. PSOs, POs and Curriculum</b>		
<b>S.No</b>	<b>Parameter</b>	<b>Observations</b>
1.	PSO's and POs attainment.	Attainments were calculated. File is maintained in the Department.
2.	PAC/DAC meetings	PAC: 26/09/2020 DAC: 19/08/2020 DAC: 20/08/2021
3.	Stakeholder's feedback and evidence related to curriculum design.	Feedbacks were Collected and a file is available in the Department.
4.	Percentage of lab component	Percentage of Lab Component: Based on number of Subjects:51.74 Based on number of Credits:47.3 Based on number of Contact Hours:22.58



  
PRINCIPAL  
Vignan's Institute of Management & Technology For Women  
Kondapur (V), Ghatkesar (M), Medchal-Malkajgiri (Dt)-501301  
Telangana State



# VIGNAN'S INSTITUTE OF MANAGEMENT AND TECHNOLOGY FOR WOMEN

(Sponsored by Lavu Educational Society)  
[Affiliated to JNTUH, Hyderabad & Approved by AICTE, New Delhi]

Kondapur (V), Ghatkesar (M), Medchal - Malkajgiri (D) - 501 301. Phone: 96529 10002/3



## II. Faculty information and their contribution

S. No	Parameter	Observations
1.	Teacher- Student ratio	12.5
2.	Faculty Cadre	Professors : 5 Associate Professors: 5 Assistant Professors: 20
3.	Faculty Qualifications	Ph.D's:6 Pursuing Ph.D:- All the other faculty have M.Tech /M.E/-
4.	Faculty contribution in writing:	Books:2 Chapters:0
5.	Awards/Rewards received:	NIL
6.	Faculty in professional organizations: And faculty contribution:	IETE: 1 ISTE: NIL IEI: 1 SDIWC: NIL IAENG: 6
7.	National level events organized -Conferences: -Workshops/ Seminars: -FDPs:  International level events organized -Conferences: -Workshops/Seminars:	<b>EVENTS ORGANISED</b> FDP: NIL WORKSHOPS : 05 SEMINARS: 04



*Radhika*  
PRINCIPAL

Vignans Institute of Management & Technology For Women  
Kondapur (V), Ghatkesar (M), Medchal-Malkajgiri (Dt)-501301  
Telangana State





# VIGNAN'S INSTITUTE OF MANAGEMENT AND TECHNOLOGY FOR WOMEN

(Sponsored by Lavu Educational Society)

[Affiliated to JNTUH, Hyderabad & Approved by AICTE, New Delhi]

Kondapur (V), Ghatkesar (M), Medchal - Malkajgiri (Dt) - 501 301. Phone: 96529 10002/3



8.	List of Conferences/seminars/workshops / FDP's/ any exclusive programs attended for enrichment of teaching - learning process	INTERNATINALCONFERENCES:4 FDP:NIL WORKSHOP : 19 STTP:NIL
9.	Faculty interaction with outside world (BOS/NBA/Examiner for PhD evaluation / selection committee / Academic auditing /Chief guest /etc. )	NIL
10.	Faculty Load	Faculty load is distributed as per AICTE Norms.  HOD: 10 HOURS/WEEK PROFESSOR: 8-12 HOURS/WEEK ASSOC.PROF: 12-16 HOURS/WEEK ASSISTANT PROF.: 16-20 HOURS/WEEK Details are made available in Work Load Particular file.



*[Handwritten Signature]*

PRINCIPAL

Vignans Institute of Management & Technology For Women  
Kondapur (V), Ghatkesar (M), Medchal-Malkajgiri (Dt)-501301  
Telangana State



### III. Teaching-Learning Process and Evaluation

S. No	Parameter	Observations
1.	Student performance indices Attendance ,Exams	Detained List: NIL Result Analysis : (PASS PERCENTAGE): II-I : 48.71 II-II :56.50 III-I:49.8 III-II:66.67 IV-I:56.07 IV-II-90.82
2.	Mechanism and activities for slow learners for their improvement and outcomes	Remedial classes were conducted for slow learners based upon their performance in Mid-I examination. <b>Details are Available in file</b>
3.	Student counseling/ mentoring mechanism	One faculty is assigned to 20 students as a mentor. Mentor is responsible of taking care of academic and other issues related to the mentee Student. Mentor books are available with the mentors. Mentors file is made available in the department.
4.	Tutorial classes	Tutorial classes were conducted regularly. Schedule is Available for both the semesters. Tutorial classes file is maintained in the department separately.
5.	Initiatives taken for innovative mini and major projects -Training for students.	Workshops and guest lectures were organized on various technologies. File is available..
6.	Best student projects with awards.	2 Projects were identified. Details are available in Project file.



  
PRINCIPAL

Vignans Institute of Management & Technology For Women  
Kondapur (V), Ghatkesar (M), Medchal-Malkajgiri (Dt)-501301  
Telangana State



# VIGNAN'S INSTITUTE OF MANAGEMENT AND TECHNOLOGY FOR WOMEN

(Sponsored by Lavu Educational Society)

[Affiliated to JNTUH, Hyderabad & Approved by AICTE, New Delhi]

Kondapur (V), Ghatkesar (M), Medchal - Malkajgiri (D) - 501 301. Phone: 96529 10002/3



7.	Monitoring of teaching--learning process -- Assessment of teaching process in Classrooms. -- Random verification of evaluated answer papers and question paper during the semester. -- Innovative teaching methods presented if any -- Verification of course files	1. HOD monitors the lesson plan for every 15 days through attendance register of the students for different subjects and also marks awarded in midterm examinations. 2. Department committee assesses whether faculty follows the bloom's taxonomy and pattern of question papers as per regulations. 3. ICT tools used by faculty are mentioned in course files. 4. Course files are verified by HOD and Department IQAC Co-ordinator before finalizing the calculation of CO and PO attainments in every semester. Files containing Lesson plans, Student performace, Course Question banks specified with COs , course materials & final assessment of all the students are available in the department.
8.	Training programs conducted for students Guest lecturers: Seminars/ workshops:	Training programs - 14 Workshops - 05 Seminars/Guest lecture - 02
9.	Students feedback	Feedback from students were collected and analyzed .
10.	Feedback follow-up action	As the feedbacks from students were satisfactory no follow-up actions are initiated. File Related to feedbacks is available in the Department.
11.	Scope for Self-learning Certificate courses Online courses	<b>Online courses (NPTEL)</b> The following faculty and Students are certified in various subjects through NPTEL No.of faculty Certified : 06 No.of Students Certified : NIL <b>(Details are maintained in separate file-NPTEL)</b>
12.	Placements (%): Industries / Organizations:	No. of Students:98 No. of Students Placed : 70
13.	Higher studies (%): Institutions:	Students Higher studies: 6 Total No. of Institutions :6 <b>(Details are maintained in Higher Studies File)</b>



  
PRINCIPAL

Vignans Institute of Management & Technology For Women  
Kondapur (V), Ghatkesar (M), Medchal-Malkajgiri (Dt)-501301  
Telangana State.



# VIGNAN'S INSTITUTE OF MANAGEMENT AND TECHNOLOGY FOR WOMEN

(Sponsored by Lavu Educational Society)

[Affiliated to JNTUH, Hyderabad & Approved by AICTE, New Delhi]

Kondapur (V), Ghatkesar (M), Medchal - Malkajgiri (Dt) - 501 301. Phone: 96529 10002/3



## IV. Research, Consultancy and Extension

Sl.No	Parameter	Observations
1.	Faculty publications in journals: Peer reviewed Journals:	International Journals : 15 National Journals : NIL Scopus Indexed : 13 SCI Indexed : 0  <b>Details are also Maintained in separate file-</b>
2.	Publications in conferences: - National: - International:	National : 0 International : 2  <b>Details are also Maintained in separate file- Publication File</b>
3.	PhDs -Registered: Submitted: Awarded:  PhDs guiding /guided:	PhDs -Registered : <b>03</b> Submitted : NIL Awarded : NIL PhDs guiding /guided: 02
4.	Funded R&D projects and Consultancy work Applied: Ongoing: Completed:	Applied : <b>05</b> Ongoing : NIL Completed : 05
5.	Faculty intellectual property rights	IPR : <b>14</b>
6.	R&D grants & projects and their outcomes.	05
7.	MOU's with industries/ R&D/ Premier institutes	MOU's with Industries : 05 R&D : NIL Premier Institutes : NIL
8.	Research centers of excellence established:	NIL
9.	Faculty involved in research and Consultancy.	Number of faculty involved in research and Consultancy : <b>04</b>



  
PRINCIPAL  
Vignans Institute of Management & Technology For Women  
Kondapur (V), Ghatkesar (M), Medchal-Malkajgiri (Dt)-501301  
Telangana State



# VIGNAN'S INSTITUTE OF MANAGEMENT AND TECHNOLOGY FOR WOMEN

(Sponsored by Lavu Educational Society)

[Affiliated to JNTUH, Hyderabad & Approved by AICTE, New Delhi]

Kondapur (V), Ghatkesar (M), Medchal - Malkajgiri (D) - 501 301. Phone: 96529 10002/3



## V. Infrastructure and Learning Resources

Sl. No	Parameter	Observations
1.	Adequacy of infrastructural facilities to improve the teaching learning process Class rooms: Laboratories: ICT class rooms / e- Class Rooms: Seminar halls: Faculty rooms:	Class rooms : 06 Laboratories : 06 E-Class room : 03 Seminar halls : 01 Faculty Rooms : 01
2.	Internet facilities for faculty & Students:	1. Wi-Fi facility is provided to Staff and Students Laptops. 2. Internet facility provided to all computers in Laboratories. 3. All the faculty staff rooms are provided with both LAN and Wi-Fi internet facility.
3.	Technical manpower support	Programmer - 10 Hardware Mechanic - NIL Lab. Technician - 01 Office Assistant - NIL Training Assistant - NIL Total manpower support - 11
4.	Modern / new equipment added in laboratories	30 – i5, 10 <sup>th</sup> gen computers were added.
5.	Details of computing facilities and Improvement.	All the lab requirements are met.
6.	Department level library resources with Details.	Text books 184 - Digital Library: Can access through LAN



  
PRINCIPAL

Vignan's Institute of Management & Technology For Women  
Kondapur (V), Ghatkesar (M), Medchal-Malkajgiri (Dt)-501301  
Telangana State



# VIGNAN'S INSTITUTE OF MANAGEMENT AND TECHNOLOGY FOR WOMEN

(Sponsored by Lavu Educational Society)

[Affiliated to JNTUH, Hyderabad & Approved by AICTE, New Delhi]

Kondapur (V), Ghatkesar (M), Medchal - Malkajiri (D) - 501 301. Phone: 96529 10002/3



## VI. Student information, Support and Progression

Sl. No	Parameter	Observations
1.	Add-on courses:	Add-on Courses: 05  Details on Add-on Courses are maintained in a file
2.	Student prizes: Scholarships	1. Student Prizes - 2 2. Scholarship - 8 3. Department student clubs - 2
3.	Details of coaching provided for GATE/GRE/any other Competitive Exams.	CRT Programs are initiated. Company Specific training is given for placements.
4.	Internships	Internships - 25



PRINCIPAL

Vignans Institute of Management & Technology For Women  
Kondapur (V), Ghatkesar (M), Medchal-Malkajiri (Dt)-501301  
Telangana State



# VIGNAN'S INSTITUTE OF MANAGEMENT AND TECHNOLOGY FOR WOMEN

(Sponsored by Lavu Educational Society)

[Affiliated to JNTUH, Hyderabad & Approved by AICTE, New Delhi]

Kondapur (V), Ghatkesar (M), Medchal - Malkajgiri (D) - 501 301. Phone: 96529 10002/3



## VII. Governance, Leadership and Management

Sl. No	Parameter	Observations
1.	Teaching and Non-Teaching staff attended for skill development programs	Teaching staff: 33 Non-teaching staff: 11
2.	MoUs with premier Institutions for knowledge exchange	01
3.	Quality policy & Quality objectives Committees & duties: Cells & duties:	IQAC is taking care of Qualitative measures.
4.	Maintenance factor -physical observation -Biometric -Attendance monitoring system	1. Attendance register (physical) is maintained for faculty. It is countersigned by Principal daily. 2. Student's attendance is monitored daily and absentee's information is sent to their parents through SMS. 3. Attendance registers of the students (physical) is maintained and countersigned by HOD regularly. 4. The Students having less than 75% attendance information is maintained and informed to the parents periodically. <b>(Registers are maintained in Department office)</b>
5.	Financial support/leaves for qualification/skill up- gradation:	Financial Incentives were given as per the Institute Policy . Details are made available in a Separate file.
6.	Risk evaluation/safety measures:	Safety measures are properly followed in all the labs.



  
PRINCIPAL  
Vignans Institute of Management & Technology For Women  
Kondapur (V), Ghatkesar (M), Medchal-Malkajgiri (D)-501301  
Telangana State



# VIGNAN'S INSTITUTE OF MANAGEMENT AND TECHNOLOGY FOR WOMEN

(Sponsored by Lavu Educational Society)

[Affiliated to JNTUH, Hyderabad & Approved by AICTE, New Delhi]

Kondapur (V), Ghatkesar (M), Medchal - Malkajgiri (D) - 501 301. Phone: 96529 10002/3



## 1. Suggestions for improvement:

1. No research projects.
2. Enhance modern Teaching Learning
3. Improve Publications
4. Books and conferences number to be improved.

Sign of Department Coordinator:

  
(R. Krishna Nayak)

Sign of Academic Auditors

1.   
(T. Dileep)
2.   
(T. Prathal)
3.   
(M. Shyam Sunder)

Sign of HOD:

  
(Dr. J. Ranga Swamy)

**Head of the Department**  
**Computer Science and Engineering**  
Vignans Institute of Management and Technology for Women  
Kondapur (V), Ghatkesar (M), R.R. Dist-501 301.

Sign of IQAC Coordinator:

  
Co-ordinator  
Internal Quality Assurance Cell  
Vignans Institute of Management & Technology For Women  
Kondapur (V), Ghatkesar (M), Medchal-Malkajgiri (Dt)-501301  
Telangana State



  
**PRINCIPAL**  
Vignans Institute of Management & Technology For Women  
Kondapur (V), Ghatkesar (M), Medchal-Malkajgiri (Dt)-501301  
Telangana State





**INTERNAL QUALITY ASSURANCE CELL**

**ACADEMIC & ADMINISTRATIVE AUDIT**

**REPORT**

**Evaluation Sheet**

Department Name : **INFORMATION TECHNOLOGY**

Programme Name : **B. Tech**

Academic Year : **2020-21**

<b>I. PSOs, POs and Curriculum</b>		
<b>S.No</b>	<b>Parameter</b>	<b>Observations</b>
1.	PSO's and POs attainment.	PO attainments were calculated upto 2 <sup>nd</sup> Year.
2.	DAC meetings	DAC meetings were conducted on 24/08/2020 and 22/3/2021. PAC meetings were conducted on 24/08/2020 and 28/3/2021.  Files are maintained in the department.
3.	Stakeholder's feedback and evidence related to curriculum design.	Feedbacks were Collected and a file is available in the Department.
4.	Extent of its satisfaction with curriculum revision	Since the program started in 2019 . Alumni and employers feedback are not required..
5.	Percentage of lab component	<b>Percentage of Lab Components</b> Based on number of Subjects:37.50 Based on number of Credits:21.42 Based on number of Contact Hours :54.54



  
**PRINCIPAL**  
Vignans Institute of Management & Technology For Women  
Kondapur (V), Ghatkesar (M), Medchal-Malkajgiri (Dt)-501301



# VIGNAN'S INSTITUTE OF MANAGEMENT AND TECHNOLOGY FOR WOMEN

(Sponsored by Lavu Educational Society)

[Affiliated to JNTUH, Hyderabad & Approved by AICTE, New Delhi]

Kondapur (V), Ghatkesar (M), Medchal - Malkajiri (D) - 501 301. Phone: 96529 10002/3



## II. Faculty information and their contribution

S. No	Parameter	Observations
1.	Teacher- Student ratio	( 35/4) = 8.75
2.	Faculty Cadre	Professors :0 Associate Professors:2 Assistant Professors:2
3.	Faculty Qualifications	Ph.D's:0 Pursuing Ph.D:1 All the faculty have M.Tech/M.E/
4.	Faculty contribution in writing:	NIL
5.	Awards/Rewards received:	NIL
6.	Faculty in professional organizations: And faculty contribution:	IAENG : 3
7.	National level events organized -Conferences: -Workshops/ Seminars: -FDPs:  International level events organized -Conferences: -Workshops/Seminars:	NIL
8.	List of Conferences/seminars/ workshops / FDP's/ any exclusive programs attended for enrichment of teaching - learning process	FDP:2 WORKSHOP :3 CONFERENCES:0



*[Signature]*

PRINCIPAL

Vignans Institute of Management & Technology For Women  
Kondapur (V), Ghatkesar (M), Medchal-Malkajiri (Dt)-501301  
Telangana State



# VIGNAN'S INSTITUTE OF MANAGEMENT AND TECHNOLOGY FOR WOMEN

(Sponsored by Lavu Educational Society)

[Affiliated to JNTUH, Hyderabad & Approved by AICTE, New Delhi]

Kondapur (V), Ghatkesar (M), Medchal - Malkajgiri (Dt) - 501 301. Phone: 96529 10002/3



9.	Faculty interaction with outside world (BOS/NBA/Examiner for PhD evaluation / selection committee / Academic auditing /Chief guest /etc. )	NIL
10.	Faculty Load	Faculty load is distributed as per AICTE Norms.  HOD: 10 HOURS/WEEK PROFESSOR: 8-12 HOURS/WEEK ASSOC.PROF: 12-16 HOURS/WEEK ASSISTANT PROF.: 16-20 HOURS/WEEK Details are made available in Work Load Particular file.



  
PRINCIPAL  
Vignans Institute of Management & Technology For Women  
Kondapur (V), Ghatkesar (M), Medchal-Malkajgiri (Dt)-501301  
Telangana State



### III. Teaching-Learning Process and Evaluation

S. No	Parameter	Observations
1.	Student performance indices Attendance ,Exams	Detained Students: 2  EXAMS: (PAS PERCENTAGE): II-I : 80.00% II-II : 57.14
2.	Mechanism and activities for slow learners for their improvement and outcomes	Make up classes conducted for slow learners based upon their performance in Mid-I examination. (If the student get the <60% of marks in Mid Examination then we conducted Remedial classes.) <b>Details are Available in file</b>
3.	Student counseling/ mentoring mechanism	One faculty is assigned to 20 students as a mentor. Mentor is responsible of taking care of academic and other issues related to the mentee Student. Mentor books are available with the mentors. Mentors file is made available in the department.
4.	Tutorial classes	Tutorial classes were conducted regularly. Schedule is Available for both the semesters. Tutorial classes file is maintained in the department separately.
5.	Initiatives taken for innovative mini and major projects -Training for students.	CRT Program is initiated.
6.	Best student projects with awards.	NA



  
PRINCIPAL  
Vignans Institute of Management & Technology For Women  
Kondapur (V), Ghatkesar (M), Medchal-Malkajgiri (Dt)-501301  
Telangana State



# VIGNAN'S INSTITUTE OF MANAGEMENT AND TECHNOLOGY FOR WOMEN

(Sponsored by Lavu Educational Society)  
[Affiliated to JNTUH, Hyderabad & Approved by AICTE, New Delhi]

Kondapur (V), Ghatkesar (M), Medchal - Malkajgiri (D) - 501 301. Phone: 96529 10002/3



7.	Monitoring of teaching--learning process -- Assessment of teaching process in Classrooms. -- Random verification of evaluated answer papers and question paper during the semester. -- Innovative teaching methods presented if any -- Verification of course files	1. HOD monitors the lesson plan for every 15 days through attendance register of the students for different subjects and also marks awarded in midterm examinations. 2. Department committee assesses whether faculty follows the bloom's taxonomy and pattern of question papers as per regulations. 3. ICT tools used by faculty are mentioned in course files. 4. Course files are verified by HOD and Department IQAC Co-ordinator before finalizing the calculation of CO and PO attainments in every semester. Files containing Lesson plans, Student performance, Course Question banks specified with COs, course materials & final assessment of all the students are available in the department.
8.	Training programs conducted for students Guest lecturers: Seminars/ workshops:	Training programs Workshops - 1 Seminars - 3
9.	Students feedback	Feedback from students were collected and analyzed.
10.	Feedback follow-up action	As the feedbacks from students were satisfactory no follow-up actions are initiated. File Related to feedbacks is available in the Department.
11.	Scope for Self-learning Certificate courses Online courses	<b>Online courses (NPTEL)</b> The following faculty and Students are certified in various subjects through NPTEL No.of faculty Certified : 1 No.of Students Certified : 0 <b>(Details are maintained in separate file-NPTEL)</b>
12.	Placements (%): Industries / Organizations:	NA



  
PRINCIPAL  
Vignans Institute of Management & Technology For Women  
Kondapur (V), Ghatkesar (M), Medchal-Malkajgiri (Dt)-501301  
Telangana State



# VIGNAN'S INSTITUTE OF MANAGEMENT AND TECHNOLOGY FOR WOMEN

(Sponsored by Lavu Educational Society)

[Affiliated to JNTUH, Hyderabad & Approved by AICTE, New Delhi]

Kondapur (V), Ghatkesar (M), Medchal - Malkajgiri (D) - 501 301. Phone: 96529 10002/3



CSE & ECE

13.	Higher studies (%): Institutions:	NA
-----	--------------------------------------	----

## IV. Research, Consultancy and Extension

Sl.No	Parameter	Observations
1.	Faculty publications in journals: Peer reviewed Journals:	International Journals : 7 Scopus Indexed : 1 SCI Indexed : 0 <b>Details are also Maintained in separate file-Publication File</b>
2.	Publications in conferences: - National: - International:	International : 1 <b>Scopus</b> : <b>SCI</b> : <b>Details are also Maintained in separate file-Publication File</b>
3.	PhDs -Registered: Submitted: Awarded: PhDs guiding /guided:	PhDs -Registered : 0 Submitted : 0 Awarded : 0 <b>PhDs guiding /guided:0</b>
4.	Funded R&D projects and Consultancy work	Applied : 2 Ongoing : 1 Completed : 0
5.	Faculty intellectual property rights	IPR : PATENT : 1
6.	R&D grants & projects and their outcomes.	R&D/Consultancy grants : 1. (One Lakh Rupees only)
7.	MOU's with industries/ R&D/ Premier institutes	1
8.	Research centers of excellence established:	NIL
9.	Faculty involved in research and Consultancy.	Number of faculty involved in research and Consultancy : 1



*[Signature]*  
PRINCIPAL

Vignans Institute of Management & Technology For Women  
Kondapur (V), Ghatkesar (M), Medchal-Malkajgiri (D)-501301  
Telangana State



### V. Infrastructure and Learning Resources

Sl. No	Parameter	Observations
1.	Adequacy of infrastructural facilities to improve the teaching learning process Class rooms: Laboratories: ICT class rooms / e- Class Rooms: Seminar halls: Faculty rooms:	Class rooms : 1 Laboratories : 1 E-Class room : 1 Seminar halls : 1 Faculty Rooms : 1
2.	Internet facilities for faculty & Students:	1. Wi-Fi facility is provided to Staff and Students Laptops. 2. Internet facility provided to all computers in Laboratories. 3. All the faculty staff rooms are provided with both LAN and Wi-Fi internet facility.
3.	Technical manpower support	Programmer -3 Hardware Mechanic -1 Lab. Technician -1 Office .Assistant -1 <b>Total manpower support - 6</b>
4.	Modern / new equipment added in laboratories	<b>NIL</b>
5.	Details of computing facilities and Improvement.	All the lab requirements are met.
6.	Department level library resources with Details.	Text books -- 30 Digital Library: Can access in LAN





PRINCIPAL

Vignans Institute of Management & Technology For Women  
Kondapur (V), Ghatkesar (M), Medchal-Malkajiri (Dt)-501301  
Telangana State



# VIGNAN'S INSTITUTE OF MANAGEMENT AND TECHNOLOGY FOR WOMEN

(Sponsored by Lavu Educational Society)

[Affiliated to JNTUH, Hyderabad & Approved by AICTE, New Delhi]

Kondapur (V), Ghatkesar (M), Medchal - Malkajgiri (D) - 501 301. Phone: 96529 10002/3



## VI. Student information, Support and Progression

Sl. No	Parameter	Observations
1.	Add-on courses:	Add-on Courses: 2 A Separate file is maintained on Add-on Courses.
2.	Student prizes: Scholarships	1. Student Prizes -0 2. Scholarship - 3
3.	Details of coaching provided for GATE/GRE/any other Competitive Exams.	CRT Programs are initiated.
4.	Internships	0



  
PRINCIPAL  
Vignans Institute of Management & Technology For Women  
Kondapur (V), Ghatkesar (M), Medchal-Malkajgiri (Dt)-501301  
Telangana State





## VII. Governance, Leadership and Management

Sl. No	Parameter	Observations
1.	Teaching and Non-Teaching staff attended for skill development programs	Teaching staff: 5 Non-teaching staff: 4 NPTEL online certificate courses: 1
2.	MoUs with premier Institutions for knowledge exchange	1
3.	Quality policy & Quality objectives Committees & duties: Cells & duties:	IQAC is taking care of Qualitative measures.
4.	Maintenance factor -physical observation -Biometric -Attendance monitoring system	1. Attendance register (physical) is maintained for faculty. It is countersigned by Principal daily. 2. Student's attendance is monitored daily and absentee's information is sent to their parents through SMS. 3. Attendance registers of the students (physical) is maintained and countersigned by HOD regularly. 4. The Students having less than 75% attendance information is maintained and informed to the parents periodically. <b>(Registers are maintained in Department office)</b>
5.	Financial support/leaves for qualification/skill up- gradation:	Financial Incentives were given as per the Institute Policy . Details are made available in a Separate file.
6.	Risk evaluation/safety measures:	Safety measures are properly followed in all the labs.



  
PRINCIPAL  
Vignans Institute of Management & Technology For Women  
Kondapur (V), Ghatkesar (M), Medchal-Malkajgiri (Dt)-501301  
Telangana State



**VIGNAN'S INSTITUTE OF MANAGEMENT AND TECHNOLOGY FOR WOMEN**

(Sponsored by Lavu Educational Society)

[Affiliated to JNTUH, Hyderabad & Approved by AICTE, New Delhi]

Kondapur (V), Ghatkesar (M), Medchal - Malkajgiri (D) - 501 301. Phone: 96529 10002/3



1. Suggestions for improvement:

1. Publications must be improved.
2. Motivation needed to improve funded projects.
3. Faculty to be encouraged to attend Professional development Programs regularly.

Sign of Department Coordinator: *Helini*  
(K. Helini)

Sign of Academic Auditors

1. *[Signature]*  
(T. Puttaiah)
2. *[Signature]*  
(T. Dilip)
3. *[Signature]*  
(D. Vishnu Varshika)

Sign of HOD : *[Signature]*  
(B. PHITIK)

*[Signature]*  
Sign of IQAC Coordinator:

Head of the Department  
Information Technology  
Vignans Institute of Management & Technology For Women  
Kondapur (V), Ghatkesar (M) Medchal-Malkajgiri (Dt.)-501301

Co-ordinator  
Internal Quality Assurance Cell  
Vignans Institute of Management & Technology For Women  
Kondapur (V), Ghatkesar (M), Medchal-Malkajgiri (Dt)-501301  
Telangana State



*[Signature]*  
PRINCIPAL  
Vignans Institute of Management & Technology For Women  
Kondapur (V), Ghatkesar (M), Medchal-Malkajgiri (Dt)-501301  
Telangana State



**INTERNAL QUALITY ASSURANCE CELL**

**ACADEMIC & ADMINISTRATIVE AUDIT  
REPORT  
Evaluation Sheet**

Department Name : BSH  
Programme Name : B. Tech  
Academic Year : 2020-21

<b>I. PSOs, POs and Curriculum</b>		
<b>S.No</b>	<b>Parameter</b>	<b>Observations</b>
1.	PSO's and POs attainment.	Attainments are calculated and a file is maintained in the department.
2.	DAC meetings	DAC meetings were conducted on 23-11-2020 & 23-03-2021 Files are maintained in the department.
3.	Stakeholder's feedback and evidence related to curriculum design.	Feedbacks were Collected and a file is available in the Department.
4.	Percentage of lab component	Percentage of Lab Component : Based on number of Subjects: 40% Based on number of Credits:24.32% Based on number of Contact Hours :38.63%



  
PRINCIPAL  
Vignan's Institute of Management & Technology For Women  
Kondapur (V), Ghatkesar (M), Medchal-Malkajgiri (Dt)-501301  
Telangana State



# VIGNAN'S INSTITUTE OF MANAGEMENT AND TECHNOLOGY FOR WOMEN

(Sponsored by Lavu Educational Society)

[Affiliated to JNTUH, Hyderabad & Approved by AICTE, New Delhi]

Kondapur (V), Ghatkesar (M), Medchal - Malkajiri (D) - 501 301. Phone: 96529 10002/3



## II. Faculty information and their contribution

S. No	Parameter	Observations
1.	Teacher- Student ratio	14.75
2.	Faculty Cadre Ratio	Professors : 1 Associate Professors: 6 Assistant Professors: 13
3.	Faculty Qualifications	Ph.D's: 2 Pursuing Ph.D: 02 All the faculty have M.Tech/M.E/M.Sc/MBA/M.A.: 18
4.	Faculty contribution in writing:	NIL
5.	Awards/Rewards received:	NIL
6.	Faculty in professional organizations: And faculty contribution:	NIL
7.	National level events organized -Conferences: -Workshops/ Seminars: -FDPs:  International level events organized -Conferences: -Workshops/Seminars:	NIL
8.	List of Conferences/seminars/ workshops / FDP's/ any exclusive programs attended for enrichment of teaching - learning process	International Conferences: 3 National Conference: 3 Workshops: 19 FDP's: 15



*ASH*

PRINCIPAL

Vignans Institute of Management & Technology For Women  
Kondapur (V), Ghatkesar (M), Medchal-Malkajiri (Dt)-501301  
Telangana State



# VIGNAN'S INSTITUTE OF MANAGEMENT AND TECHNOLOGY FOR WOMEN

(Sponsored by Lavu Educational Society)

[Affiliated to JNTUH, Hyderabad & Approved by AICTE, New Delhi]

Kondapur (V), Ghatkesar (M), Medchal - Malkajiri (D) - 501 301. Phone: 96529 10002/3



9.	Faculty interaction with outside world (BOS/NBA/Examiner for PhD evaluation / selection committee / Academic auditing /Chief guest /etc. )	NIL
10.	Faculty Load	Faculty load is distributed as per AICTE Norms.  HOD: 10 HOURS/WEEK PROFESSOR: 8-12 HOURS/WEEK ASSOC.PROF: 12-16 HOURS/WEEK ASSISTANT PROF.: 16-20 HOURS/WEEK Details are made available in Work Load Particular file.

### III. Teaching-Learning Process and Evaluation

S. No	Parameter	Observations
1.	Student performance indices Attendance ,Exams	Detained List: I-I : 02 I-II : Nil EXAMS: (PASS PERCENTAGE): I-I : 33.90% I-II : 55.44%
2.	Mechanism and activities for slow learners for their improvement and outcomes	Remedial classes conducted for slow learners based upon their performance in Mid Examinations. <b>Details are Available in file.</b>
3.	Student counseling/ mentoring mechanism	One faculty is assigned to 20 students as a mentor. Mentor is responsible of taking care of academic and other issues related to the mentee Student. Mentor books are available with the mentors. Mentors file is made available in the department.
4.	Tutorial classes	Tutorial classes were conducted regularly. Schedule is Available for both the semesters. Tutorial classes file is maintained in the department separately.



*[Signature]*

PRINCIPAL

Vignans Institute of Management & Technology For Women  
Kondapur (V), Ghatkesar (M), Medchal-Malkajiri (Dt)-501301  
Telangana State



# VIGNAN'S INSTITUTE OF MANAGEMENT AND TECHNOLOGY FOR WOMEN

(Sponsored by Lavu Educational Society)

[Affiliated to JNTUH, Hyderabad & Approved by AICTE, New Delhi]

Kondapur (V), Ghatkesar (M), Medchal - Malkajiri (D) - 501 301. Phone: 96529 10002/3



5.	Initiatives taken for innovative mini and major projects -Training for students.	NA
6.	Best student projects with awards.	NA
7.	Monitoring of teaching--learning process -- Assessment of teaching process in Classrooms. -- Random verification of evaluated answer papers and question paper during the semester. -- Innovative teaching methods presented if any -- Verification of course files	<ol style="list-style-type: none"><li>1. HOD monitors the lesson plan for every 15 days through attendance register of the students for different subjects and also marks awarded in midterm examinations.</li><li>2. Department committee assesses whether faculty are following the bloom's taxonomy and pattern of question papers as per regulations.</li><li>3. ICT tools used by faculty are mentioned in course files.</li><li>4. Course files are verified by HOD and Department IQAC Co-ordinator before finalizing the calculation of CO and PO attainments in every semester.</li></ol> <p>Files containing Lesson plans, Student performance, Course Question banks specified with COs , course materials &amp; final assessment of all the students are available in the department.</p>
8.	Training programs conducted for students Guest lecturers: Seminars/ workshops:	Training programs - Workshops - Nil Seminars - Nil Guest lectures - 02
9.	Students feedback	Feedback from students were collected and analyzed .
10.	Feedback follow-up action	As the feedbacks from students were satisfactory no follow-up actions are initiated. File Related to feedbacks is available in the Department.



*[Handwritten Signature]*

PRINCIPAL

Vignan's Institute of Management & Technology For Women  
Kondapur (V), Ghatkesar (M), Medchal-Malkajiri (Dt)-501301  
Telangana State



# VIGNAN'S INSTITUTE OF MANAGEMENT AND TECHNOLOGY FOR WOMEN

(Sponsored by Lavu Educational Society)  
[Affiliated to JNTUH, Hyderabad & Approved by AICTE, New Delhi]

Kondapur (V), Ghatkesar (M), Medchal - Malkajiri (D) - 501 301. Phone: 96529 10002/3



11.	Scope for Self-learning Certificate courses Online courses	<b>Online courses (NPTEL)</b> The following faculty and Students are certified in various subjects through NPTEL No.of faculty Certified : 04 No.of Students Certified : Nil
12.	Placements (%): Industries / Organizations:	NA
13.	Higher studies (%): Institutions:	NA

## IV. Research, Consultancy and Extension

Sl.No	Parameter	Observations
1.	Faculty publications in journals: Peer reviewed Journals:	International Journals : 01 National Journals : 01 Scopus Indexed : 01 SCI Indexed : Nil Details are also Maintained in separate file- Publication File
2.	Publications in conferences: - National: - International:	National : 0 International : 01 Scopus : 0 SCI : 0 Details are also Maintained in separate file- Publication File
3.	PhDs -Registered: Submitted: Awarded:  PhDs guiding /guided:	PhDs -Registered : Nil Submitted : Nil Awarded : Nil  PhDs guiding /guided: Nil



PRINCIPAL

Vignani's Institute of Management & Technology For Women  
Kondapur (V), Ghatkesar (M), Medchal-Malkajiri (Dt)-501301  
Telangana State



# VIGNAN'S INSTITUTE OF MANAGEMENT AND TECHNOLOGY FOR WOMEN

(Sponsored by Lavu Educational Society)

[Affiliated to JNTUH, Hyderabad & Approved by AICTE, New Delhi]

Kondapur (V), Ghatkesar (M), Medchal - Malkajgiri (D) - 501 301. Phone: 96529 10002/3



4.	Funded R&D projects and Consultancy work Applied: Ongoing: Completed:	NIL
5.	Faculty intellectual property rights	NIL
6.	R&D grants & projects and their outcomes.	NIL
7.	MOU's with industries/ R&D/ Premier institutes	NIL
8.	Research centers of excellence established:  Outcome in research centers:	NIL
9.	Faculty involved in research and Consultancy.	NIL



PRINCIPAL

Vignans Institute of Management & Technology For Women  
Kondapur (V), Ghatkesar (M), Medchal-Malkajgiri (Dt)-501301  
Telangana State





# VIGNAN'S INSTITUTE OF MANAGEMENT AND TECHNOLOGY FOR WOMEN

(Sponsored by Lavu Educational Society)

[Affiliated to JNTUH, Hyderabad & Approved by AICTE, New Delhi]

Kondapur (V), Ghatkesar (M), Medchal - Malkajgiri (D) - 501 301. Phone: 96529 10002/3



## V. Infrastructure and Learning Resources

Sl. No	Parameter	Observations
1.	Adequacy of infrastructural facilities to improve the teaching learning process Class rooms: Laboratories: ICT class rooms / e- Class Rooms: Seminar halls: Faculty rooms	Class rooms : 05 Laboratories : 05 E-Class room : 01 Seminar halls : 01 Faculty Rooms : 01
2.	Internet facilities for faculty & Students:	1. Wi-Fi facility is provided to Staff and Students Laptops. 2. Internet facility provided to all computers in Laboratories. All the faculty staff rooms are provided with both LAN and Wi-Fi internet facility
3.	Technical manpower support	Hardware Mechanic - Nil Lab. Technician - 05 Office .Assistant - 01 <b>Total manpower support - 06</b>
4.	Modern / new equipment added in laboratories	<b>NIL</b>
5.	Details of computing facilities and Improvement.	All the lab requirements are met.
6.	Department level library resources with Details.	Text books -- 90 <b>Digital Library: Can access in LAN</b>



*[Signature]*  
PRINCIPAL

Vignans Institute of Management & Technology For Women  
Kondapur (V), Ghatkesar (M), Medchal-Malkajgiri (Dt)-501301  
Telangana State



# VIGNAN'S INSTITUTE OF MANAGEMENT AND TECHNOLOGY FOR WOMEN

(Sponsored by Lavu Educational Society)

[Affiliated to JNTUH, Hyderabad & Approved by AICTE, New Delhi]

Kondapur (V), Ghatkesar (M), Medchal - Malkajiri (D) - 501 301. Phone: 96529 10002/3



## VI. Student information, Support and Progression

Sl. No	Parameter	Observations
1.	Induction Programs	Orientation program is conducted for first year students.
2.	Student prizes: Scholarships Dept. Student clubs:	1. Student publication – Nil 2. Student Prizes – Nil 3. Scholarship – 8
3.	Details of coaching provided for GATE/GRE/any other Competitive Exams.	NIL
4.	Internships	NIL





PRINCIPAL

Vignans Institute of Management & Technology For Women  
Kondapur (V), Ghatkesar (M), Medchal-Malkajiri (Dt)-501301  
Telangana State



# VIGNAN'S INSTITUTE OF MANAGEMENT AND TECHNOLOGY FOR WOMEN

(Sponsored by Lavu Educational Society)

[Affiliated to JNTUH, Hyderabad & Approved by AICTE, New Delhi]

Kondapur (V), Ghatkesar (M), Medchal - Malkajiri (D) - 501 301. Phone: 96529 10002/3



## VII. Governance, Leadership and Management

Sl. No	Parameter	Observations
1.	Teaching and Non-Teaching staff attended for skill development programs	Teaching staff: Nil Non-teaching staff: 06 NPTEL online certificate courses Number of faculty Certified : Nil
2.	MoUs with premier Institutions for knowledge exchange	NIL
3.	Quality policy & Quality objectives Committees & duties: Cells & duties:	IQAC is taking care of Qualitative measures.
4.	Maintenance factor -physical observation -Biometric -Attendance monitoring system	1. Attendance register (physical) is maintained for faculty. It is countersigned by Principal daily. 2. Student's attendance is monitored daily and absentee's information is sent to their parents through SMS. 3. Attendance registers of the students (physical) is maintained and countersigned by HOD regularly. 4. The Students having less than 75% attendance information is maintained and informed to the parents periodically. <b>(Registers are maintained in Department office)</b>
5.	Financial support/leaves for qualification/skill up- gradation:	Financial Incentives were given as per the Institute Policy . Details are made available in a Separate file.
6.	Risk evaluation/safety measures:	Safety measures are properly followed in all the labs.



  
PRINCIPAL

Vignans Institute of Management & Technology For Women  
Kondapur (V), Ghatkesar (M), Medchal-Malkajiri (Dt)-501301  
Telangana State



# VIGNAN'S INSTITUTE OF MANAGEMENT AND TECHNOLOGY FOR WOMEN

(Sponsored by Lavu Educational Society)  
[Affiliated to JNTUH, Hyderabad & Approved by AICTE, New Delhi]

Kondapur (V), Ghatkesar (M), Medchal - Malkajgiri (D) - 501 301. Phone: 96529 10002/3



## 1. Suggestions for improvement:

1. No Research Projects are available.
2. Motivation required to faculty for quality publications.
3. Encourage faculty to attend more FDP's.

Sign of Department Coordinator: *[Signature]*  
(V. Mohan Krishna)

Sign of Academic Auditors

1. *[Signature]*  
(M. Vishnu Varadharaj)
2. *[Signature]*  
(T. Pullatah)
3. *[Signature]*  
(T. Dileep)

Sign of HOD: *[Signature]*

*[Signature]*  
Sign of IQAC Coordinator:

**Head of the Department**  
**Basic Sciences and Humanitie**  
Vignan's Institute of Management and Technology for Women  
Kondapur (V), Ghatkesar (M), R.R. Dist-501 301.

Co-ordinator  
**Internal Quality Assurance Cell**  
Vignan's Institute of Management & Technology For Women  
Kondapur (V), Ghatkesar (M), Medchal-Malkajgiri (Dt)-501301  
Telangana State



*[Signature]*  
**PRINCIPAL**  
Vignan's Institute of Management & Technology For Women  
Kondapur (V), Ghatkesar (M), Medchal-Malkajgiri (Dt)-501301  
Telangana State



**INTERNAL QUALITY ASSURANCE CELL**

**ACADEMIC & ADMINISTRATIVE AUDIT  
REPORT**

**Evaluation Sheet**

Department Name : **Electronics and Communication Engineering**  
Programme Name : **B. Tech**  
Academic Year : **2020-21**

<b>I. PSOs, POs and Curriculum</b>		
<b>S.No</b>	<b>Parameter</b>	<b>Observations</b>
1.	PSO's and POs attainment.	Attainments were calculated. File is maintained in the Department.
2.	PAC/DAC meetings	PAC meeting was conducted on : 22-08-2020 DAC meeting was conducted on:05/09/2020 DAC meeting was conducted on:20/03/2021  Files are available in the department.
3.	Stakeholder's feedback and evidence related to curriculum design.	Feedbacks were Collected and a file is available in the Department.
4.	Percentage of lab component	Percentage of Lab Component: Based on number of Subjects:50.00 Based on number of Credits:19.58 Based on number of Contact Hours:39.57



  
**PRINCIPAL**  
Vignans Institute of Management & Technology For Women  
Kondapur (V), Ghatkesar (M), Medchal-Malkajgiri (Dt)-501301  
Telangana State



# VIGNAN'S INSTITUTE OF MANAGEMENT AND TECHNOLOGY FOR WOMEN

Sponsored by Lavu Educational Society, Approved by AICTE, New Delhi & Affiliated to JNTUH, Hyderabad.  
Kondapur (V), Ghatkesar (M), Medchal - Malkajiri (D) - 501 301 Phone: +91 96529 10002/3



## II. Faculty information and their contribution

S. No	Parameter	Observations
1.	Teacher- Student ratio	(314/22)=14.27
2.	Faculty Cadre	Professors : 3 Associate Professors: 4 Assistant Professors: 15
3.	Faculty Qualifications	Ph.D's:3 Pursuing Ph.D:-4 All the other faculty have M.Tech /M.E/-19
4.	Faculty contribution in writing:	Books: 0 Chapters:4
5.	Awards/Rewards received:	NIL
6.	Faculty in professional organizations: And faculty contribution:	IETE : 1 ISTE:1 ORCID:2
7.	National level events organized -Conferences: -Workshops/ Seminars: -FDPs:  International level events organized -Conferences: -Workshops/Seminars:	EVENTS ORGANISED FDP: 0 WORKSHOPS: 0 SEMINARS: 3
8.	List of Conferences/seminars/ workshops / FDP's/ any exclusive programs attended for enrichment of teaching - learning process	FDP:8 WORKSHOP : 5 CONFERENCES: 1



  
PRINCIPAL

Vignan's Institute of Management & Technology For Women  
Kondapur (V), Ghatkesar (M), Medchal-Malkajiri (Dt)-501301  
Telangana State



# VIGNAN'S INSTITUTE OF MANAGEMENT AND TECHNOLOGY FOR WOMEN

Sponsored by Lavu Educational Society, Approved by AICTE, New Delhi & Affiliated to JNTUH, Hyderabad.  
Kondapur (V), Ghatkesar (M), Medchal - Malkajgiri (D) - 501 301 Phone: +91 96529 10002/3



9.	Faculty interaction with outside world (BOS/NBA/Examiner for PhD evaluation / selection committee / Academic auditing /Chief guest /etc. )	NIL
10.	Faculty Load	Faculty load is distributed as per AICTE Norms. HOD: 10 HOURS/WEEK PROFESSOR: 8-12 HOURS/WEEK ASSOC.PROF: 12-16 HOURS/WEEK ASSISTANT PROF.: 16-20 HOURS/WEEK Details are made available in Work Load Particular file.



  
PRINCIPAL  
Vignans Institute of Management & Technology For Women  
Kondapur (V), Ghatkesar (M), Medchal-Malkajgiri (Dt)-501301  
Telangana State



### III. Teaching-Learning Process and Evaluation

S. No	Parameter	Observations
1.	Student performance indices Attendance .Exams	Detailed List: II-I: 1 Result Analysis : (PASS PERCENTAGE): II-I : 19 II-II :33 III-I:59.82 III-II:42.86 IV-I:64.36 IV-II-94.06
2.	Mechanism and activities for slow learners for their improvement and outcomes	Remedial classes were conducted for slow learners based upon their performance in Mid-I examination. <b>Details are Available in file</b>
3.	Student counseling/ mentoring mechanism	One faculty is assigned to 20 students as a mentor. Mentor is responsible of taking care of academic and other issues related to the mentee Student. Mentor books are available with the mentors. Mentors file is made available in the department.
4.	Tutorial classes	Tutorial classes were conducted regularly. Schedule is Available for both the semesters. Tutorial classes file is maintained in the department separately.
5.	Initiatives taken for innovative mini and major projects -Training for students.	Workshops and guest lectures were organized on various technologies. File is available.
6.	Best student projects with awards.	2 Projects were identified. Details are available in Project file.



*[Handwritten Signature]*

PRINCIPAL

Vignan's Institute of Management & Technology For Women  
Kondapur (V), Ghatkesar (M), Medchal-Malkajgiri (Dt)-501301  
Telangana State





# VIGNAN'S INSTITUTE OF MANAGEMENT AND TECHNOLOGY FOR WOMEN

Sponsored by Lavu Educational Society, Approved by AICTE, New Delhi & Affiliated to JNTUH, Hyderabad.  
Kondapur (V), Ghatkesar (M), Medchal - Malkajgiri (D) - 501 301 Phone: +91 96529 10002/3



7.	Monitoring of teaching--learning process -- Assessment of teaching process in Classrooms. -- Random verification of evaluated answer papers and question paper during the semester. -- Innovative teaching methods presented if any -- Verification of course files	<ol style="list-style-type: none"><li>1. HOD monitors the lesson plan for every 15 days through attendance register of the students for different subjects and also marks awarded in midterm examinations.</li><li>2. Department committee assesses whether faculty follows the bloom's taxonomy and pattern of question papers as per regulations.</li><li>3. ICT tools used by faculty are mentioned in course files.</li><li>4. Course files are verified by HOD and Department IQAC Co-ordinator before finalizing the calculation of CO and PO attainments in every semester.</li></ol> Files containing Lesson plans, Student performance, Course Question banks specified with COs , course materials & final assessment of all the students are available in the department.
8.	Training programs conducted for students Guest lecturers: Seminars/ workshops:	Training programs Workshops -7 Seminars/Guest lecture -3
9.	Students feedback	Feedback from students were collected and analyzed.
10.	Feedback follow-up action	As the feedbacks from students were satisfactory no follow-up actions are initiated. File Related to feedbacks is available in the Department.
11.	Scope for Self-learning Certificate courses Online courses	<b>Online courses</b> The following faculty and Students are certified in various subjects through /NPTEL/Coursera No. of faculty Certified NPTEL : 1 No. of Students Certified : 20 <b>(Details are maintained in separate file-NPTEL)</b>
12.	Placements (%): Industries / Organizations:	No. of Students:101 No. of Students Placed : 83
13.	Higher studies (%): Institutions:	Students Higher studies: 3 Total No. of Institutions :3 <b>(Details are maintained in Higher Studies File)</b>



*[Handwritten Signature]*

PRINCIPAL

Vignan's Institute of Management & Technology For Women  
Kondapur (V), Ghatkesar (M), Medchal-Malkajgiri (Dt)-501301  
Telangana State



# VIGNAN'S INSTITUTE OF MANAGEMENT AND TECHNOLOGY FOR WOMEN

Sponsored by Lavu Educational Society, Approved by AICTE, New Delhi & Affiliated to JNTUH, Hyderabad.  
Kondapur (V), Ghatkesar (M), Medchal - Malkajgiri (D) - 501 301 Phone: +91 96529 10002/3



## IV. Research, Consultancy and Extension

Sl.No	Parameter	Observations
1.	Faculty publications in journals: Peer reviewed Journals:	International Journals : 5 National Journals : NIL Scopus Indexed : 2 SCI Indexed : 0 <b>Details are also Maintained in separate file-Publication File</b>
2.	Publications in conferences: - National: - International:	National : 0 International : 4 <b>Details are also Maintained in separate file-Publication File</b>
3.	PhDs -Registered: Submitted: Awarded:  PhDs guiding /guided:	PhDs -Registered : 0 Submitted : 1 Awarded : 0  PhDs guiding /guided: NIL
4.	Funded R&D projects and Consultancy work Applied: Ongoing: Completed:	Applied : 1 Ongoing : NIL Completed : 1
5.	Faculty intellectual property rights	IPR : 3 PATENTS
6.	MOU's with industries/ R&D/ Premier institutes	MOU's with Industries : 1 R&D : 1 Premier Institutes : NIL
7.	Research centers of excellence established:	NIL
8.	Faculty involved in research and Consultancy.	Number of faculty involved in research and Consultancy : 1



PRINCIPAL

Vignans Institute of Management & Technology For Women  
Kondapur (V), Ghatkesar (M), Medchal-Malkajgiri (Dt)-501301  
Telangana State



### V. Infrastructure and Learning Resources

Sl. No	Parameter	Observations
1.	Adequacy of infrastructural facilities to improve the teaching learning process Class rooms: Laboratories: ICT class rooms / e- Class Rooms: Seminar halls: Faculty rooms:	Class rooms : 6 Laboratories : 14 E-Class room : 1 Seminar halls : 1 Faculty Rooms : 1
2.	Internet facilities for faculty & Students:	1. Wi-Fi facility is provided to Staff and Students Laptops. 2. Internet facility provided to all computers in Laboratories. 3. All the faculty staff rooms are provided with both LAN and Wi-Fi internet facility.
3.	Technical manpower support	Lab. Assistant -7 Lab. Technician -1 Total manpower support - 8
4.	Modern / new equipment added in laboratories	30-Components are added in EDC lab
5.	Details of computing facilities and Improvement.	All the lab requirements are met.
6.	Department level library resources with Details.	Text books -152 Digital Library: Can access through LAN



*[Signature]*

PRINCIPAL

Vignans Institute of Management & Technology For Women  
Kondapur (V), Ghatkesar (M), Medchal-Malkajiri (Dt)-501301  
Telangana State



## VI. Student information, Support and Progression

Sl. No	Parameter	Observations
1.	Add-on courses:	Add-on Courses: 3 Details on Add-on Courses are maintained in a file
2.	Student prizes: Scholarships	1. Student Prizes - 3 2. Scholarship - 3 3. Department student clubs - 3
3.	Details of coaching provided for GATE/GRE/any other Competitive Exams.	CRT Programs are initiated. Company Specific training is given for placements.
4.	Internships	Internships -42



  
**PRINCIPAL**

Vignans Institute of Management & Technology For Women  
Kondapur (V), Ghatkesar (M), Medchal-Malkajiri (Dt)-501301  
Telangana State



<b>VII. Governance, Leadership and Management</b>		
<b>Sl. No</b>	<b>Parameter</b>	<b>Observations</b>
1.	Teaching and Non-Teaching staff attended for skill development programs	Teaching staff: 1 Non-teaching staff: 1 NPTEL online Certificate courses no of faulty certified:1
2.	MoUs with premier Institutions for knowledge exchange	1
3.	Quality policy & Quality objectives Committees & duties: Cells & duties:	IQAC is taking care of Qualitative measures.
4.	Maintenance factor -physical observation -Biometric -Attendance monitoring system	1. Attendance register (physical) is maintained for faculty. It is countersigned by Principal daily. 2. Student's attendance is monitored daily and absentee's information is sent to their parents through SMS. 3. Attendance registers of the students (physical) is maintained and countersigned by HOD regularly. 4. The Students having less than 75% attendance information is maintained and informed to the parents periodically. <b>(Registers are maintained in Department office)</b>
5.	Financial support/leaves for qualification/skill up- gradation:	Financial Incentives were given as per the Institute Policy . Details are made available in a Separate file.
6.	Risk evaluation/safety measures:	Safety measures are properly followed in all the labs.



**PRINCIPAL**

Vignans Institute of Management & Technology For Women  
Kondapur (V), Ghatkesar (M), Medchal-Malkajiri (Dt)-501301  
Telangana State



# VIGNAN'S INSTITUTE OF MANAGEMENT AND TECHNOLOGY FOR WOMEN

Sponsored by Lavu Educational Society, Approved by AICTE, New Delhi & Affiliated to JNTUH, Hyderabad.  
Kondapur (V), Ghatkesar (M), Medchal - Malkajgiri (D) - 501 301 Phone: +91 96529 10002/3





## 1. Suggestions for improvement:

1. Enhance modern Teaching Learning
2. Improve Publications
3. Motivation needed to faculty in attending FDP's.

Sign of Department Coordinator:

  
J. Smil Kumar

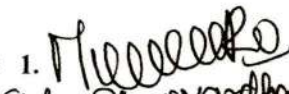
Sign of Academic Auditors

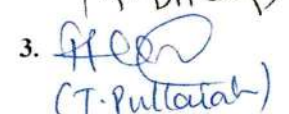
1.   
M. Vishwanath
2.   
T. Dileep
3.   
T. Pullatah

Sign of HOD :



Sign of IQAC Coordinator:



**Head of the Department**  
Electronics and Communication Engineering  
Vignans Institute of Management & Technology For Women  
Kondapur (V), Ghatkesar (M), Medchal-Malkajgiri (Dt.)-501301

**Co-ordinator**  
Internal Quality Assurance Cell  
Vignans Institute of Management & Technology For Women  
Kondapur (V), Ghatkesar (M), Medchal-Malkajgiri (Dt.)-501301  
Telangana State





**PRINCIPAL**  
Vignans Institute of Management & Technology For Women  
Kondapur (V), Ghatkesar (M), Medchal-Malkajgiri (Dt.)-501301  
Telangana State



## INTERNAL QUALITY ASSURANCE CELL

### ACADEMIC & ADMINISTRATIVE AUDIT REPORT Evaluation Sheet

Department Name : BSH  
Programme Name : B. Tech  
Academic Year : 2021-22

<b>I. PSOs, POs and Curriculum</b>		
<b>S.No</b>	<b>Parameter</b>	<b>Observations</b>
1.	PSO's and POs attainment.	PO's are calculated and a file is maintained in department on Attainments.
2.	DAC meetings	DAC meetings were conducted on 27-11-2021 & 03-06-2022 Files are maintained in the department..
3.	Stakeholder's feedback and evidence related to curriculum design.	Stake holders feedback were collected and analysed. Details are maintained in a separate file..
4.	Percentage of lab component	Percentage of Lab Component : Based on number of Subjects: 40% Based on number of Credits:24.32% Based on number of Contact Hours :38.63%



PRINCIPAL

Vignan's Institute of Management & Technology For Women  
Kondapur (V), Ghatkesar (M), Medchal-Malkajgiri (Dt)-501301  
Telangana State



# VIGNAN'S INSTITUTE OF MANAGEMENT AND TECHNOLOGY FOR WOMEN

(Sponsored by Lavu Educational Society)

[Affiliated to JNTUH, Hyderabad & Approved by AICTE, New Delhi]

Kondapur (V), Ghatkesar (M), Medchal - Malkajgiri (D) - 501 301. Phone: 96529 10002/3



## II. Faculty information and their contribution

S. No	Parameter	Observations
1.	Teacher- Student ratio	16.11
2.	Faculty Cadre Ratio	Professors : 2 Associate Professors: 6 Assistant Professors:19
3.	Faculty Qualifications	Ph.D's: 4 Pursuing Ph.D: 02 All the faculty have M.Tech/M.E/M.Sc/MBA: 23
4.	Faculty contribution in writing:	NIL
5.	Awards/Rewards received:	NIL
6.	Faculty in professional organizations:  And faculty contribution:	NIL
7.	National level events organized -Conferences: -Workshops/ Seminars: -FDPs:  International level events organized -Conferences: -Workshops/Seminars:	NIL



PRINCIPAL

Vignans Institute of Management & Technology For Women  
Kondapur (V), Ghatkesar (M), Medchal-Malkajgiri (Dt)-501301  
Telangana State





# VIGNAN'S INSTITUTE OF MANAGEMENT AND TECHNOLOGY FOR WOMEN

(Sponsored by Lavu Educational Society)

[Affiliated to JNTUH, Hyderabad & Approved by AICTE, New Delhi]

Kondapur (V), Ghatkesar (M), Medchal - Malkajgiri (D) - 501 301. Phone: 96529 10002/3



8.	List of Conferences/seminars/ workshops / FDP's/ any exclusive programs attended for enrichment of teaching - learning process	International Conferences: 3 National Conference: 5 Workshops: 16 FDP's: 20
9.	Faculty interaction with outside world (BOS/NBA/Examiner for PhD evaluation / selection committee / Academic auditing	NIL
10.	Faculty Load	Faculty load is distributed as per AICTE Norms.  HOD: 10 HOURS/WEEK PROFESSOR: 8-12 HOURS/WEEK ASSOC.PROF: 12-16 HOURS/WEEK ASSISTANT PROF.: 16-20 HOURS/WEEK Details are made available in Work Load Particular file.



  
PRINCIPAL  
Vignan's Institute of Management & Technology For Women  
Kondapur (V), Ghatkesar (M), Medchal-Malkajgiri (Dt)-501301  
Telangana State



# VIGNAN'S INSTITUTE OF MANAGEMENT AND TECHNOLOGY FOR WOMEN

(Sponsored by Lavu Educational Society)

[Affiliated to JNTUH, Hyderabad & Approved by AICTE, New Delhi]

Kondapur (V), Ghatkesar (M), Medchal - Malkajgiri (D) - 501 301. Phone: 96529 10002/3



## III. Teaching-Learning Process and Evaluation

S. No	Parameter	Observations
1.	Student performance indices Attendance ,Exams	Attendance : Detained List:  I-I : 05 I-II : Nil  EXAMS: (PASS PERCENTAGE): I-I : 66.74% I-II : 65.36%
2.	Mechanism and activities for slow learners for their improvement and outcomes	Remedial classes were conducted for slow learners based upon their performance in Mid examination. Remedial classes details are maintained in Remedial Classes file.
3.	Student counseling/ mentoring mechanism	One faculty mentor attached to 20 students from I B. Tech to look after the career, academic and personal problems. Details of every student is maintained in Student Mentor Book.
4.	Tutorial classes	Tutorials are conducted as per curriculum and sheets are available in faculty course files and in a separate file. Tutorial Hours also specified in regular Time Table.
5.	Initiatives taken for innovative mini and major projects -Training for students & faculty	NA
6.	Best student projects with awards.	NA



  
PRINCIPAL  
Vignans Institute of Management & Technology For Women  
Kondapur (V), Ghatkesar (M), Medchal-Malkajgiri (Dt)-501301  
Telangana State



# VIGNAN'S INSTITUTE OF MANAGEMENT AND TECHNOLOGY FOR WOMEN

(Sponsored by Lavu Educational Society)

[Affiliated to JNTUH, Hyderabad & Approved by AICTE, New Delhi]

Kondapur (V), Ghatkesar (M), Medchal - Malkajgiri (D) - 501 301. Phone: 96529 10002/3



7.	<p>Monitoring of teaching--learning process</p> <ul style="list-style-type: none"> <li>-- Assessment of teaching process in Classrooms.</li> <li>-- Random verification of evaluated answer papers and question paper during the semester.</li> <li>-- Innovative teaching methods presented if any</li> <li>-- Verification of course files</li> </ul>	<ol style="list-style-type: none"> <li>1. HOD monitors the lesson plan for every 15 days through attendance register of the students for different subjects and also marks awarded in midterm examinations.</li> <li>2. Department committee assesses whether faculty are following the bloom's taxonomy and pattern of question papers as per regulations.</li> <li>3. PPT's and videos, if any, used by faculty are mentioned in course files.</li> </ol> <p>Course files are verified by department and Department IQAC Co-ordinator before finalizing the calculation of CO and PO attainments in every semester. (Maintained in separate files- containing Lesson plans, Student performance, Course Question banks specified with COs , course materials &amp; final assessment of all the students.)</p>
8.	<p>Training programs conducted for students Guest lecturers: Seminars/ workshops:</p>	<p><b>Training programs</b> - Workshops - Nil Seminars - Nil Guest lecturers - 5</p>
9.	Students feedback	1. Feedback were collected in all the semesters.
10.	Feedback follow-up action	<ol style="list-style-type: none"> <li>2. The feedback reports are available in the file.</li> <li>3. The follow up action is to be initiated only for that faculty who have feedback less than 3 out of 5 scale, as there was no faculty having feedback less than 3 in this academic year. No follow-up action required.</li> </ol> <p><b>Details are maintained in feedback file</b></p>



*[Signature]*  
PRINCIPAL

Vignani's Institute of Management & Technology For Women  
Kondapur (V), Ghatkesar (M), Medchal-Malkajgiri (Dt)-501301  
Telangana State



# VIGNAN'S INSTITUTE OF MANAGEMENT AND TECHNOLOGY FOR WOMEN

(Sponsored by Lavu Educational Society)

[Affiliated to JNTUH, Hyderabad & Approved by AICTE, New Delhi]

Kondapur (V), Ghatkesar (M), Medchal - Malkajgiri (D) - 501 301. Phone: 96529 10002/3



11.	Scope for Self-learning Certificate courses Online courses	NIL
12.	Placements (%): Industries / Organizations:	NA
13.	Higher studies (%): Institutions:	NA

## IV. Research, Consultancy and Extension

Sl.No	Parameter	Observations
1.	Faculty publications in journals: Peer reviewed Journals:	International Journals : 0 National Journals : 0 Scopus Indexed : 4 SCI Indexed : 2 <b>Details are also Maintained in separate file- Publication File</b>
2.	Publications in conferences: - National: - International:	NIL
3.	PhDs -Registered: Submitted: Awarded:  PhDs guiding /guided:	PhDs -Registered : Nil Submitted : Nil Awarded : Nil PhDs guiding /guided: Nil



PRINCIPAL

Vignans Institute of Management & Technology For Women  
Kondapur (V), Ghatkesar (M), Medchal-Malkajgiri (Dt)-501301  
Telangana State



# VIGNAN'S INSTITUTE OF MANAGEMENT AND TECHNOLOGY FOR WOMEN

(Sponsored by Lavu Educational Society)

[Affiliated to JNTUH, Hyderabad & Approved by AICTE, New Delhi]

Kondapur (V), Ghatkesar (M), Medchal - Malkajgiri (D) - 501 301. Phone: 96529 10002/3



4.	Funded R&D projects and Consultancy work Applied: Ongoing: Completed:	NIL
5.	Faculty intellectual property rights	NIL;
6.	R&D grants & projects and their outcomes.	NIL
7.	MOU's with industries/ R&D/ Premier institutes	NIL;
8.	Research centers of excellence established:  Outcome in research centers:	NIL
9.	Faculty involved in research and Consultancy.	NIL



*[Handwritten Signature]*

PRINCIPAL

Vignan's Institute of Management & Technology For Women  
Kondapur (V), Ghatkesar (M), Medchal-Malkajgiri (Dt)-501301  
Telangana State



# VIGNAN'S INSTITUTE OF MANAGEMENT AND TECHNOLOGY FOR WOMEN

(Sponsored by Lavu Educational Society)

[Affiliated to JNTUH, Hyderabad & Approved by AICTE, New Delhi]

Kondapur (V), Ghatkesar (M), Medchal - Malkajgiri (D) - 501 301. Phone: 96529 10002/3



## V. Infrastructure and Learning Resources

Sl. No	Parameter	Observations
1.	Adequacy of infrastructural facilities to improve the teaching learning process Class rooms: Laboratories: ICT class rooms / e- Class Rooms: Seminar halls: Faculty rooms:	Class rooms : 07 Laboratories : 05 E-Class room : 01 Seminar halls : 01 Faculty Rooms : 02
2.	Internet facilities for faculty & Students:	1. Wi-Fi facility also provided to Staff and Students Laptops. 2. Internet facility provided to all computers in Laboratories. Department Office and Staff rooms are having internet by LAN and Wi-Fi.
3.	Technical manpower support	Lab. Technician - 05 Office Assistant - 01 <b>Total manpower support - 06</b>
4.	Modern / new equipment added in laboratories	Nil
5.	Details of computing facilities and Improvement.	All the Labs are equipped with adequate facilities as needed.
6.	Department level library resources with Details.	Text books -- 105 <b>Digital Library: Can access in LAN</b> ( Details are maintained in College Website



PRINCIPAL

Vignans Institute of Management & Technology For Women  
Kondapur (V), Ghatkesar (M), Medchal-Malkajgiri (Dt)-501301  
Telangana State



# VIGNAN'S INSTITUTE OF MANAGEMENT AND TECHNOLOGY FOR WOMEN

(Sponsored by Lavu Educational Society)

[Affiliated to JNTUH, Hyderabad & Approved by AICTE, New Delhi]

Kondapur (V), Ghatkesar (M), Medchal - Malkajgiri (D) - 501 301. Phone: 96529 10002/3



## VI. Student information, Support and Progression

Sl. No	Parameter	Observations
1.	Bridge courses: Add-on courses: Induction Programs	Orientation program conducted for New join students. Induction programs were organized. Details are available in department file.
2.	Student prizes: Scholarships Dept. Student clubs:	1. Student publication – Nil 2. Student Prizes – 09 3. Scholarship – 211 Department student clubs – Nil
3.	Details of coaching provided for GATE/GRE/any other Competitive Exams.	NA
4.	Internships	NA



  
PRINCIPAL  
Vignans Institute of Management & Technology For Women  
Kondapur (V), Ghatkesar (M), Medchal-Malkajgiri (Dt)-501301  
Telangana State



# VIGNAN'S INSTITUTE OF MANAGEMENT AND TECHNOLOGY FOR WOMEN

(Sponsored by Lavu Educational Society)

[Affiliated to JNTUH, Hyderabad & Approved by AICTE, New Delhi]

Kondapur (V), Ghatkesar (M), Medchal - Malkajgiri (D) - 501 301. Phone: 96529 10002/3



## VII. Governance, Leadership and Management

Sl. No	Parameter	Observations
1.	Teaching and Non-Teaching staff attended for skill development programs	Teaching staff: Nil Non-teaching staff: 05 NPTEL online certificate courses Number of faculty Certified : Nil
2.	MoUs with premier Institutions for knowledge exchange	NIL
3.	Quality policy & Quality objectives Committees & duties: Cells & duties:	IQAC is monitoring the Quantitative and Qualitative measures
4.	Maintenance factor -physical observation -Biometric -Attendance monitoring system	1. Attendance register (physical) is maintained for faculty. It is countersigned by Principal daily. 2. Student's attendance is monitored daily and absentee's information is sent to their parents through SMS. 3. Attendance registers of the students (physical) is maintained and countersigned by HOD regularly. 4. The Students having less than 75% attendance information is maintained and informed to the parents periodically. <b>(Registers are maintained in Department office)</b>
5.	Financial support/leaves for qualification/skill up- gradation:	Financial incentive is being given for publishing papers in peer reviewed journals and for attending the FDP, Conferences. File related to this is maintained in the Department.
6.	Risk evaluation/safety measures:	Safety measures are disseminated as Fire Extinguishers are provided in all laboratories.



  
PRINCIPAL  
Vignan's Institute of Management & Technology For Women  
Kondapur (V), Ghatkesar (M), Medchal-Malkajgiri (Dt)-501301  
Telangana State





# VIGNAN'S INSTITUTE OF MANAGEMENT AND TECHNOLOGY FOR WOMEN

(Sponsored by Lavu Educational Society)

[Affiliated to JNTUH, Hyderabad & Approved by AICTE, New Delhi]

Kondapur (V), Ghatkesar (M), Medchal - Malkajgiri (D) - 501 301. Phone: 96529 10002/3



## 1. Suggestions for improvement:

1. No research projects are available.
2. Faculty must be encouraged to publish more papers.
3. Motivate faculty to attend more FDP's.

Sign of Department Coordinator:

  
(MD. Khalid A.)

Sign of Academic Auditors 1.

  
(Dr. P. Rajendra Prasad)

2.   
(Dr. V. Sruja)

3.   
(K. Helini)

Sign of HOD:

  
Head of the Department  
Basic Sciences and Humanities  
Vignan's Institute of Management and Technology for Women  
Kondapur (V), Ghatkesar (M), R.R. Dist-501 301

Sign of IQAC Coordinator:

  
(G. Rajesh)  
Co-ordinator  
Internal Quality Assurance Cell  
Vignan's Institute of Management & Technology For Women  
Kondapur (V), Ghatkesar (M), Medchal-Malkajgiri (Dt)-501301  
Telangana State





PRINCIPAL  
Vignan's Institute of Management & Technology For Women  
Kondapur (V), Ghatkesar (M), Medchal-Malkajgiri (Dt)-501301  
Telangana State



**INTERNAL QUALITY ASSURANCE CELL**

**ACADEMIC & ADMINISTRATIVE AUDIT**

**REPORT**

**Evaluation Sheet**

Department Name : **INFORMATION TECHNOLOGY**

Programme Name : **B. Tech**

Academic Year : **2021-22**

<b>I. PSOs, POs and Curriculum</b>		
<b>S.No</b>	<b>Parameter</b>	<b>Observations</b>
1.	PSO's and POs attainment.	PO attainments were calculated for 2 <sup>nd</sup> and 3 <sup>rd</sup> Year. Details are made available in Department file.
2.	PAC/DAC meetings	PAC meeting was conducted on : 16/09/2021 and 10/03/2022. DAC meeting was conducted on:06/09/2021 and 03/03/2022.
3.	Stakeholder's feedback and evidence related to curriculum design.	Stake holders feedbacks were collected and analyzed.  Details are maintained in a separate file.
4.	Extent of its satisfaction with curriculum revision	No alumni and employers feedback as the program started in 2019.
5.	Percentage of lab component	<b>Percentage of Lab Component</b> Based on number of Subjects:48.2 Based on number of Credits: 19.76 Based on number of Contact Hours :49.27



PRINCIPAL

Vignan's Institute of Management & Technology For Women  
Kondapur (V), Ghatkesar (M), Medchal-Malkajgiri (Dt)-501301  
Telangana State



# VIGNAN'S INSTITUTE OF MANAGEMENT AND TECHNOLOGY FOR WOMEN

(Sponsored by Lavu Educational Society)

[Affiliated to JNTUH, Hyderabad & Approved by AICTE, New Delhi]

Kondapur (V), Ghatkesar (M), Medchal - Malkajgiri (D) - 501 301. Phone: 96529 10002/3



## II. Faculty information and their contribution

S. No	Parameter	Observations
1.	Teacher- Student ratio	(84/7)=12
2.	Faculty Cadre Ratio	Professors :0 Associate Professors:3 Assistant Professors:4
3.	Faculty Qualifications	Ph.D's:0 Pursuing Ph.D:1 All the faculty have M.Tech/M.E/
4.	Faculty contribution in writing:	Books:3 Chapters:6
5.	Awards/Rewards received:	NIL
6.	Faculty in professional organizations: And faculty contribution:	IAENG: 3
7.	National level events organized -Conferences: -Workshops/ Seminars: -FDPs:  International level events organized -Conferences: -Workshops/Seminars:	NIL
8.	List of Conferences/seminars/ workshops / FDP's/ any exclusive programs attended for enrichment of teaching - learning process	FDP:7 WORKSHOP : 4 CONFERENCES: 3



PRINCIPAL

Vignan's Institute of Management & Technology For Women  
Kondapur (V), Ghatkesar (M), Medchal-Malkajgiri (Dt)-501301  
Telangana State



# VIGNAN'S INSTITUTE OF MANAGEMENT AND TECHNOLOGY FOR WOMEN

(Sponsored by Lavu Educational Society)

[Affiliated to JNTUH, Hyderabad & Approved by AICTE, New Delhi]

Kondapur (V), Ghatkesar (M), Medchal - Malkajgiri (D) - 501 301. Phone: 96529 10002/3



9.	Faculty interaction with outside world (BOS/NBA/Examiner for PhD evaluation / selection committee / Academic auditing /Chief guest /etc. )	NIL
10.	Faculty Load	Faculty load is distributed as per AICTE Norms. Work Load Particular file is available. HOD: 10 HOURS/WEEK PROFESSOR: 8-12 HOURS/WEEK ASSOC.PROF: 12-16 HOURS/WEEK ASSISTANT PROF.: 16-20 HOURS/WEEK

PRINCIPAL

Vignan's Institute of Management & Technology For Women  
Kondapur (V), Ghatkesar (M), Medchal-Malkajgiri (Dt)-501301  
Telangana State





# VIGNAN'S INSTITUTE OF MANAGEMENT AND TECHNOLOGY FOR WOMEN

(Sponsored by Lavu Educational Society)

[Affiliated to JNTUH, Hyderabad & Approved by AICTE, New Delhi]

Kondapur (V), Ghatkesar (M), Medchal - Malkajgiri (D) - 501 301. Phone: 96529 10002/3



## III. Teaching-Learning Process and Evaluation

S. No	Parameter	Observations
1.	Student performance indices Attendance ,Exams	Attendance : Detained List: NIL Result Analysis:  II-I : 42.86 III-I: 40.00 II-II: 78.72 III-II:82.86
2.	Mechanism and activities for slow learners for their improvement and outcomes	Remedial classes were conducted for slow learners based upon their performance in Mid examination. Remedial classes details are maintained in Remedial Classes file.
3.	Student counseling/ mentoring mechanism	One faculty mentor attached to 20 students from II ,III B. Tech to look after the career, academic and personal problems. Details of every student is maintained in Student Mentor Book.
4.	Tutorial classes	Tutorials were conducted as per curriculum and sheets are available in faculty course files. Tutorial Hours also specified in regular Time Table
5.	Initiatives taken for innovative mini and major projects -Training for students & faculty	As the student are still in 2 <sup>nd</sup> and 3 <sup>rd</sup> year, no such Programs were conducted.
6.	Best student projects with awards.	NA



  
PRINCIPAL

Vignans Institute of Management & Technology For Women  
Kondapur (V), Ghatkesar (M), Medchal-Malkajgiri (Dt)-501301  
Telangana State



# VIGNAN'S INSTITUTE OF MANAGEMENT AND TECHNOLOGY FOR WOMEN

(Sponsored by Lavu Educational Society)

[Affiliated to JNTUH, Hyderabad & Approved by AICTE, New Delhi]

Kondapur (V), Ghatkesar (M), Medchal - Malkajgiri (D) - 501 301. Phone: 96529 10002/3



7.	Monitoring of teaching--learning process -- Assessment of teaching process in Classrooms. -- Random verification of evaluated answer papers and question paper during the semester. -- Innovative teaching methods presented if any -- Verification of course files	<ol style="list-style-type: none"><li>1. HOD monitors the lesson plan for every 15 days through attendance register of the students for different subjects and also marks awarded in midterm examinations.</li><li>2. Department committee assesses whether faculty are following the bloom's taxonomy and pattern of question papers as per regulations.</li><li>3. PPT's and videos, if any, used by faculty are mentioned in course files.</li></ol> <p>Course files are verified by department and Department IQAC Co-ordinator before finalizing the calculation of CO and PO attainments in every semester. (Maintained in separate files- containing Lesson plans, Student performance, Course Question banks specified with COs , course materials &amp; final assessment of all the students.)</p>
8.	Training programs conducted for students Guest lecturers: Seminars/ workshops:	Training programs Workshops - 1 Seminars - 2
9.	Students feedback	1. Feedback were collected in all the semesters.
10.	Feedback follow-up action	2. The feedback reports are available in the file. 3. The follow up action is to be initiated only for that faculty who have feedback less than 3 out of 5 scale, as there was no faculty having feedback less than 3 in this academic year. No follow-up action required. Details are maintained in feedback file
11.	Scope for Self-learning Certificate courses Online courses	NPTEL No.of faculty Certified : NIL No.of Students Certified : NIL



  
PRINCIPAL

Vignans Institute of Management & Technology For Women  
Kondapur (V), Ghatkesar (M), Medchal-Malkajgiri (Dt)-501301  
Telangana State



# VIGNAN'S INSTITUTE OF MANAGEMENT AND TECHNOLOGY FOR WOMEN

(Sponsored by Lavu Educational Society)

[Affiliated to JNTUH, Hyderabad & Approved by AICTE, New Delhi]

Kondapur (V), Ghatkesar (M), Medchal - Malkajiri (D) - 501 301. Phone: 96529 10002/3



12.	Placements (%): Industries / Organizations:	NA
13.	Higher studies (%): Institutions:	NA

## IV. Research, Consultancy and Extension

Sl.No	Parameter	Observations
1.	Faculty publications in journals: Peer reviewed Journals:	International Journals : 5 Scopus Indexed : 1 SCI Indexed : 0 Details are also Maintained in separate file- Publication File
2.	Publications in conferences: - National: - International:	International : 1
3.	PhDs -Registered: Submitted: Awarded:  PhDs guiding /guided:	PhDs -Registered :NIL Submitted : NIL Awarded : NIL  <b>PhDs guiding /guided:NIL</b>
4.	Funded R&D projects and Consultancy work Applied: Ongoing: Completed:	Applied :2 Ongoing :NIL Completed :1
5.	Faculty intellectual property rights	IPR : PATENTS - 2



*[Signature]*

PRINCIPAL

Vignan's Institute of Management & Technology For Women  
Kondapur (V), Ghatkesar (M), Medchal-Malkajiri (Dt)-501301  
Telangana State



# VIGNAN'S INSTITUTE OF MANAGEMENT AND TECHNOLOGY FOR WOMEN

(Sponsored by Lavu Educational Society)

[Affiliated to JNTUH, Hyderabad & Approved by AICTE, New Delhi]

Kondapur (V), Ghatkesar (M), Medchal - Malkajgiri (D) - 501 301. Phone: 96529 10002/3



6.	R&D grants & projects and their outcomes.	R&D/Consultancy grants : 1(Rs.55,000)
7.	MOU's with industries/ R&D/ Premier institutes	2
8.	Research centers of excellence established:  Outcome in research centers:	1
9.	Faculty involved in research and Consultancy.	Number of faculty involved in research and Consultancy :1



  
PRINCIPAL  
Vignans Institute of Management & Technology For Women  
Kondapur (V), Ghatkesar (M), Medchal-Malkajgiri (Dt)-501301  
Telangana State





# VIGNAN'S INSTITUTE OF MANAGEMENT AND TECHNOLOGY FOR WOMEN

(Sponsored by Lavu Educational Society)

[Affiliated to JNTUH, Hyderabad & Approved by AICTE, New Delhi]

Kondapur (V), Ghatkesar (M), Medchal - Malkajgiri (D) - 501 301. Phone: 96529 10002/3



## V. Infrastructure and Learning Resources

Sl. No	Parameter	Observations
1.	Adequacy of infrastructural facilities to improve the teaching learning process Class rooms: Laboratories: ICT class rooms / e- Class Rooms: Seminar halls: Faculty rooms:	Class rooms : 2 Laboratories : 2 E-Class room : 1 Seminar halls : 1 Faculty Rooms : 1
2.	Internet facilities for faculty & Students:	1. Wi-Fi facility also provided to Staff and Students Laptops. 2. Internet facility provided to all computers in Laboratories. Department Office and Staff rooms are having internet by LAN and Wi-Fi.
3.	Technical manpower support	Programmer -5 Hardware Mechanic -1 Lab. Technician -1 Office .Assistant -NIL Training Assistant -1 Total manpower support - 8
4.	Modern / new equipment added in laboratories	NIL
5.	Details of computing facilities and Improvement.	All the Labs are equipped with adequate computing facilities as needed.
6.	Department level library resources with Details.	Text books -- 50 Digital Library: Can access through LAN



PRINCIPAL

Vignans Institute of Management & Technology For Women  
Kondapur (V), Ghatkesar (M), Medchal-Malkajgiri (Dt)-501301  
Telangana State



# VIGNAN'S INSTITUTE OF MANAGEMENT AND TECHNOLOGY FOR WOMEN

(Sponsored by Lavu Educational Society)

[Affiliated to JNTUH, Hyderabad & Approved by AICTE, New Delhi]

Kondapur (V), Ghatkesar (M), Medchal - Malkajgiri (D) - 501 301. Phone: 96529 10002/3



## VI. Student information, Support and Progression

Sl. No	Parameter	Observations
1.	Bridge courses: Add-on courses:	Add-on Courses: 2  Details on Add-on Courses are maintained in a file.
2.	Student prizes: Scholarships Dept. Student clubs:	1. Student Prizes - 5 2. Scholarship -2 3. Department student clubs -2
3.	Details of coaching provided for GATE/GRE/any other Competitive Exams.	As the students are in 3 <sup>rd</sup> Year only CRT related programs were initiated. Company Specific Training is proposed in the final year.
4.	Internships	Internships -- NIL



  
PRINCIPAL  
Vignans Institute of Management & Technology For Women  
Kondapur (V), Ghatkesar (M), Medchal-Malkajgiri (Dt)-501301  
Telangana State



# VIGNAN'S INSTITUTE OF MANAGEMENT AND TECHNOLOGY FOR WOMEN

(Sponsored by Lavu Educational Society)

[Affiliated to JNTUH, Hyderabad & Approved by AICTE, New Delhi]

Kondapur (V), Ghatkesar (M), Medchal - Malkajiri (D) - 501 301. Phone: 96529 10002/3



## VII. Governance, Leadership and Management

Sl. No	Parameter	Observations
1.	Teaching and Non-Teaching staff attended for skill development programs	Teaching staff: 7 Non-teaching staff: NIL Number of faculty Certified :
2.	MoUs with premier Institutions for knowledge exchange	2
3.	Quality policy & Quality objectives Committees & duties: Cells & duties:	IQAC is monitoring the Quantitative and Qualitative measures.
4.	Maintenance factor -physical observation -Biometric -Attendance monitoring system	1. Attendance register (physical) is maintained for faculty. It is countersigned by Principal daily. 2. Student's attendance is monitored daily and absentee's information is sent to their parents through SMS. 3. Attendance registers of the students (physical) is maintained and countersigned by HOD regularly. 4. The Students having less than 75% attendance information is maintained and informed to the parents periodically. <b>(Registers are maintained in Department office)</b>
5.	Financial support/leaves for qualification/skill up- gradation:	Financial incentive is being given for publishing papers in peer reviewed journals and for attending the FDP, Conferences. File related to this is maintained in the Department.
6.	Risk evaluation/safety measures:	Safety measures are disseminated as Fire Extinguishers are provided in all laboratories.



  
PRINCIPAL  
Vignan's Institute of Management & Technology For Women  
Kondapur (V), Ghatkesar (M), Medchal-Malkajiri (Dt)-501301  
Telangana State



# VIGNAN'S INSTITUTE OF MANAGEMENT AND TECHNOLOGY FOR WOMEN

(Sponsored by Lavu Educational Society)

[Affiliated to JNTUH, Hyderabad & Approved by AICTE, New Delhi]

Kondapur (V), Ghatkesar (M), Medchal - Malkajgiri (D) - 501 301. Phone: 96529 10002/3



## 1. Suggestions for improvement:

1. Motivation to the faculty for books and conferences is required.
2. Improvement required in sponsored research projects.
3. Students internships need to be initiated.
4. Academic and industry linkages need to be promoted.

Sign of Department Coordinator:

*Rupa*  
(RUPA)

Sign of Academic Auditors 1.

1. *P. Rajendra Reddy*  
(Dr. P. Rajendra Reddy)
2. *S. V. Srinivas*  
(Dr. V. Srinivas)
3. *Helini*  
(K. Helini)

Sign of HOD :

*B. Phirajik*  
(B. PHIRAJIK)

Head of the Department  
Information Technology

Vignans Institute of Management & Technology For Women  
Kondapur (V), Ghatkesar (M) Medchal-Malkajgiri (Dt.)-501301

Sign of IQAC Coordinator:

*G. Rajesh*  
(G. Rajesh)

Co-ordinator

Internal Quality Assurance Cell

Vignans Institute of Management & Technology For Women  
Kondapur (V), Ghatkesar (M), Medchal-Malkajgiri (Dt)-501301  
Telangana State



*Principals*

PRINCIPAL

Vignans Institute of Management & Technology For Women  
Kondapur (V), Ghatkesar (M), Medchal-Malkajgiri (Dt)-501301  
Telangana State



**INTERNAL QUALITY ASSURANCE CELL**

**ACADEMIC & ADMINISTRATIVE AUDIT REPORT**

**Evaluation Sheet**

Department Name : **Computer Science and Engineering**

Programme Name : **B. Tech**

Academic Year : **2021-22**

**I. PSOs, POs and Curriculum**

S.No	Parameter	Observations
1.	PSO's and POs attainment.	PO attainments were calculated. Details are made available in Department file.
2.	PAC/DAC meetings	PAC :25/09/2021 DAC: 12/08/2021 DAC: 11/03/2022  File is maintained in the Department.
3.	Stakeholder's feedback and evidence related to curriculum design.	Stake holders feedbacks were collected and analyzed.  Details are maintained in a separate file.
4.	Percentage of lab component	Percentage of Lab Component: Based on number of Subjects:5.072 Based on number of Credits:34.6 Based on number of Contact Hours:21.42



PRINCIPAL

Vignan's Institute of Management & Technology For Women  
Kondapur (V), Ghatkesar (M), Medchal-Malkajgiri (Dt)-501301  
Telangana State



# VIGNAN'S INSTITUTE OF MANAGEMENT AND TECHNOLOGY FOR WOMEN

(Sponsored by Lavu Educational Society)

[Affiliated to JNTUH, Hyderabad & Approved by AICTE, New Delhi]

Kondapur (V), Ghatkesar (M), Medchal - Malkajgiri (D) - 501 301. Phone: 96529 10002/3



## II. Faculty information and their contribution

S. No	Parameter	Observations
1.	Teacher- Student ratio	12.83
2.	Faculty Cadre Ratio	Professors : 4 Associate Professors: 5 Assistant Professors: 28
3.	Faculty Qualifications	Ph.D's:5 Pursuing Ph.D: All the other faculty have M.Tech /M.E/
4.	Faculty contribution in writing:	Books:4 Chapters: 8
5.	Awards/Rewards received:	NIL
6.	Faculty in professional organizations: And faculty contribution:	IETE: 1 ISTE: 5 IEI: 3 SDIWC: 7 IAENG: 9
7.	National level events organized -Conferences: -Workshops/ Seminars: -FDPs: International level events organized -Conferences: -Workshops/Seminars:	EVENTS ORGANISED FDP: NIL WORKSHOPS : 02 SEMINARS: 05
8.	List of Conferences/seminars/ workshops / FDP's/ any exclusive programs attended for enrichment of teaching - learning process	INTERNATIONAL CONFERENCES:2 WORKSHOP : 12 FDP: NIL STTP:3
9.	Faculty interaction with outside world (BOS/NBA/Examiner for PhD evaluation / selection committee / Academic auditing /Chief guest /etc. )	NIL
10.	Faculty Load	Faculty load is distributed as per AICTE Norms. Work Load Particular file is available. HOD: 10 HOURS/WEEK PROFESSOR: 8-12 HOURS/WEEK ASSOC.PROF: 12-16 HOURS/WEEK ASSISTANT PROF.: 16-20 HOURS/WEEK



PRINCIPAL

Vignan's Institute of Management & Technology For Women  
Kondapur (V), Ghatkesar (M), Medchal-Malkajgiri (Dt)-501301  
Telangana State



### III. Teaching-Learning Process and Evaluation

S. No	Parameter	Observations
1.	Student performance indices Attendance ,Exams	Detained List: NIL Result Analysis : (PASS PERCENTAGE): II-I : 63.79 II-II :76.67 III-I:52.26 III-II:72.22 IV-I:59.48 IV-II 95.6
2.	Mechanism and activities for slow learners for their improvement and outcomes	Remedial classes were conducted for slow learners based upon their performance in Mid examination. Remedial classes details are maintained in Remedial Classes file.
3.	Student counseling/ mentoring mechanism	One faculty mentor attached to 20 students from II ,III B. Tech to look after the career, academic and personal problems. Details of every student is maintained in Student Mentor Book.
4.	Tutorial classes	Tutorials were conducted as per curriculum and sheets are available in faculty course files. Tutorial Hours also specified in regular Time Table
5.	Initiatives taken for innovative mini and major projects -Training for students & faculty	Workshops and Seminars were organized. Details are maintained in a file.
6.	Best student projects with awards.	<b>2 Projects were selected.</b> <b>Details are available in project file.</b>



PRINCIPAL

Vignans Institute of Management & Technology For Women  
Kondapur (V), Ghatkesar (M), Medchal-Malkajgiri (Dt)-501301  
Telangana State



# VIGNAN'S INSTITUTE OF MANAGEMENT AND TECHNOLOGY FOR WOMEN

(Sponsored by Lavu Educational Society)

[Affiliated to JNTUH, Hyderabad & Approved by AICTE, New Delhi]

Kondapur (V), Ghatkesar (M), Medchal - Malkajgiri (D) - 501 301. Phone: 96529 10002/3



7.	Monitoring of teaching--learning process -- Assessment of teaching process in Classrooms. -- Random verification of evaluated answer papers and question paper during the semester. -- Innovative teaching methods presented if any -- Verification of course files	1. HOD monitors the lesson plan for every 15 days through attendance register of the students for different subjects and also marks awarded in midterm examinations.  2. Department committee assesses whether faculty are following the bloom's taxonomy and pattern of question papers as per regulations.  3. PPT's and videos, if any, used by faculty are mentioned in course files.  Course files are verified by department and Department IQAC Co-ordinator before finalizing the calculation of CO and PO attainments in every semester. (Maintained in separate files- containing Lesson plans, Student performance, Course Question banks specified with COs , course materials & final assessment of all the students.)
8.	Training programs conducted for students Guest lecturers: Seminars/ workshops:	Training programs - 11 Workshops - 05 Seminars/ Guest lectures - 01
9.	Students feedback	1. Feedback were collected in all the semesters.
10.	Feedback follow-up action	2. The feedback reports are available in the file. 3. The follow up action is to be initiated only for that faculty who have feedback less than 3 out of 5 scale, as there was no faculty having feedback less than 3 in this academic year. No follow-up action required.  Details are maintained in feedback file



PRINCIPAL

Vignans Institute of Management & Technology For Women  
Kondapur (V), Ghatkesar (M), Medchal-Malkajgiri (Dt)-501301  
Telangana State





# VIGNAN'S INSTITUTE OF MANAGEMENT AND TECHNOLOGY FOR WOMEN

(Sponsored by Lavu Educational Society)

[Affiliated to JNTUH, Hyderabad & Approved by AICTE, New Delhi]

Kondapur (V), Ghatkesar (M), Medchal - Malkajgiri (D) - 501 301. Phone: 96529 10002/3



11.	Scope for Self-learning Certificate courses Online courses	NPTEL No.of faculty Certified : 02 No.of Students Certified : NIL
12.	Placements (%): Industries / Organizations:	No. of Students: 116 No. of Students Placed : 102
13.	Higher studies (%): Institutions:	Students Higher studies: 1 Total No. of Institutions : 1 <b>(Details are maintained in Higher Studies File)</b>

## IV. Research, Consultancy and Extension

SLNo	Parameter	Observations
1.	Faculty publications in journals: Peer reviewed Journals:	International Journals : 18 National Journals : NIL Scopus Indexed : 1 SCI Indexed : 4 <b>Details are also Maintained in separate file-Publication File</b>
2.	Publications in conferences: - National: - International:	National : 0 International : 3 <b>Details are also Maintained in separate file-Publication File</b>
3.	PhDs -Registered: Submitted: Awarded:  PhDs guiding /guided:	PhDs -Registered : NIL Submitted : NIL Awarded : 02 PhDs guiding /guided: 02
4.	Funded R&D projects and Consultancy work Applied: Ongoing: Completed:	Applied : 05 Ongoing : NIL Completed : 05
5.	Faculty intellectual property rights	IPR : 09



  
PRINCIPAL  
Vignan's Institute of Management & Technology For Women  
Kondapur (V), Ghatkesar (M), Medchal-Malkajgiri (Dt)-501301  
Telangana State



# VIGNAN'S INSTITUTE OF MANAGEMENT AND TECHNOLOGY FOR WOMEN

(Sponsored by Lavu Educational Society)

[Affiliated to JNTUH, Hyderabad & Approved by AICTE, New Delhi]

Kondapur (V), Ghatkesar (M), Medchal - Malkajgiri (D) - 501 301. Phone: 96529 10002/3



6.	R&D grants & projects and their outcomes.	05
7.	MOU's with industries/ R&D/ Premier institutes	MOU's with Industries : 13 R&D : NIL Premier Institutes : NIL
8.	Research centers of excellence established:  Outcome in research centers:	NIL
9.	Faculty involved in research and Consultancy.	Number of faculty involved in research and Consultancy : 02



  
PRINCIPAL  
Vignan's Institute of Management & Technology For Women  
Kondapur (V), Ghatkesar (M), Medchal-Malkajgiri (Dt)-501301  
Telangana State



# VIGNAN'S INSTITUTE OF MANAGEMENT AND TECHNOLOGY FOR WOMEN

(Sponsored by Lavu Educational Society)

[Affiliated to JNTUH, Hyderabad & Approved by AICTE, New Delhi]

Kondapur (V), Ghatkesar (M), Medchal - Malkajgiri (D) - 501 301. Phone: 96529 10002/3



## V. Infrastructure and Learning Resources

Sl. No	Parameter	Observations
1.	Adequacy of infrastructural facilities to improve the teaching learning process Class rooms: Laboratories: ICT class rooms / e- Class Rooms: Seminar halls: Faculty rooms:	Class rooms : 06 Laboratories : 06 E-Class room : 03 Seminar halls : 01 Faculty Rooms : 01
2.	Internet facilities for faculty & Students:	1. Wi-Fi facility also provided to Staff and Students Laptops. 2. Internet facility provided to all computers in Laboratories. Department Office and Staff rooms are having internet by LAN and Wi-Fi.
3.	Technical manpower support	Programmer - 07 Hardware Mechanic - 01 Lab. Technician - 01 Office Assistant - NIL Training Assistant - NIL Total manpower support - 09
4.	Modern / new equipment added in laboratories	30 - i3, 4 <sup>th</sup> gen computers were added.
5.	Details of computing facilities and Improvement.	All the Labs are equipped with adequate computing facilities as needed.
6.	Department level library resources with Details.	Text books : 205 Digital Library: Can access through LAN



PRINCIPAL

Vignans Institute of Management & Technology For Women  
Kondapur (V), Ghatkesar (M), Medchal-Malkajgiri (Dt)-501301  
Telangana State



# VIGNAN'S INSTITUTE OF MANAGEMENT AND TECHNOLOGY FOR WOMEN

(Sponsored by Lavu Educational Society)

[Affiliated to JNTUH, Hyderabad & Approved by AICTE, New Delhi]

Kondapur (V), Ghatkesar (M), Medchal - Malkajgiri (D) - 501 301. Phone: 96529 10002/3



## VI. Student information, Support and Progression

Sl. No	Parameter	Observations
1.	Bridge courses: Add-on courses:	Add-on Courses: 5 Details on Add-on Courses are maintained in a file.
2.	Student prizes: Scholarships Dept. Student clubs:	1. Student Prizes - 6 2. Scholarship - 7 3. Department student clubs - 2
3.	Details of coaching provided for GATE/GRE/any other Competitive Exams.	CRT related programs were initiated. Company Specific Training is proposed in the final year.
4.	Internships	Internships - 51



PRINCIPAL

Vignan's Institute of Management & Technology For Women  
Kondapur (V), Ghatkesar (M), Medchal-Malkajgiri (Dt)-501301  
Telangana State



## VII. Governance, Leadership and Management

Sl. No	Parameter	Observations
1.	Teaching and Non-Teaching staff attended for skill development programs	Teaching staff: 34 Non-teaching staff: 09
2.	MoUs with premier Institutions for knowledge exchange	NIL
3.	Quality policy & Quality objectives Committees & duties: Cells & duties:	IQAC is monitoring the Quantitative and Qualitative measures.
4.	Maintenance factor -physical observation -Biometric -Attendance monitoring system	1. Attendance register (physical) is maintained for faculty. It is countersigned by Principal daily. 2. Student's attendance is monitored daily and absentee's information is sent to their parents through SMS. 3. Attendance registers of the students (physical) is maintained and countersigned by HOD regularly. 4. The Students having less than 75% attendance information is maintained and informed to the parents periodically. <b>(Registers are maintained in Department office)</b>
5.	Financial support/leaves for qualification/skill up- gradation:	Financial incentive is being given for publishing papers in peer reviewed journals and for attending the FDP, Conferences. File related to this is maintained in the Department.
6.	Risk evaluation/safety measures:	Safety measures are disseminated as Fire Extinguishers are provided in all laboratories.



PRINCIPAL

Vignani's Institute of Management & Technology For Women  
Kondapur (V), Ghatkesar (M), Medchal-Malkajgiri (Dt)-501301  
Telangana State



# VIGNAN'S INSTITUTE OF MANAGEMENT AND TECHNOLOGY FOR WOMEN

(Sponsored by Lavu Educational Society)

[Affiliated to JNTUH, Hyderabad & Approved by AICTE, New Delhi]

Kondapur (V), Ghatkesar (M), Medchal - Malkajgiri (D) - 501 301. Phone: 96529 10002/3



## 1. Suggestions for improvement:

1. Innovative teaching Learning to be improved.
2. Motivate faculty to apply for research Projects.
3. Motivation to the faculty for books and conferences is needed.
4. More students to be involved in Extension activities.

Sign of Department Coordinator:

*M. Vishnu Varthana*  
(M. Vishnu Varthana)

Sign of Academic Auditors

1. *Helini*  
(K. Helini)
2. *Paf*  
(Dr. P. Rajendra Prasad)
3. *Smrta*  
(Dr. V. Smrta)

Sign of HOD :

*AR*

Head of the Department  
Computer Science and Engineering  
Vignans Institute of Management and Technology for Women  
Kondapur (V), Ghatkesar (M), R.R. Dist-501 301.

Sign of IQAC Coordinator:

*G. Rajesh*  
(G. Rajesh)

Co-ordinator  
Internal Quality Assurance Cell  
Vignans Institute of Management & Technology For Women  
Kondapur (V), Ghatkesar (M), Medchal-Malkajgiri (D)-501301  
Telangana State  
Internal Quality Assurance Cell  
Co-ordinator



*AR*

PRINCIPAL  
Vignans Institute of Management & Technology For Women  
Kondapur (V), Ghatkesar (M), Medchal-Malkajgiri (D)-501301  
Telangana State



## INTERNAL QUALITY ASSURANCE CELL

### ACADEMIC & ADMINISTRATIVE AUDIT REPORT

#### Evaluation Sheet

Department Name : AI & ML

Programme Name : B. Tech

Academic Year : 2021-22

<b>I. PSOs, POs and Curriculum</b>		
<b>S.No</b>	<b>Parameter</b>	<b>Observations</b>
1.	PSO's and POs attainment.	PO attainments were calculated upto 2 <sup>nd</sup> Year.
2.	PAC/DAC meetings	PAC meeting was conducted on : <b>14/10/2021</b> DAC meeting was conducted on: <b>11/10/2021</b>  Files are available in the department.
3.	Stakeholder's feedback and evidence related to curriculum design.	Stake holders feedbacks were collected and analyzed.  Details are maintained in a separate file..
4.	Extent of its satisfaction with curriculum revision	No alumni and employers feedback as the program started in 2020.
5.	Percentage of lab component	Percentage of Lab Component: Based on number of Subjects:31.25 Based on number of Credits:16.6 Based on number of Contact Hours:36.84



PRINCIPAL

Vignans Institute of Management & Technology For Women  
Kondapur (V), Ghatkesar (M), Medchal-Malkajgiri (Dt)-501301  
Telangana State



# VIGNAN'S INSTITUTE OF MANAGEMENT AND TECHNOLOGY FOR WOMEN

(Sponsored by Lavu Educational Society)

[Affiliated to JNTUH, Hyderabad & Approved by AICTE, New Delhi]

Kondapur (V), Ghatkesar (M), Medchal - Malkajgiri (D) - 501 301. Phone: 96529 10002/3



## II. Faculty information and their contribution

S. No	Parameter	Observations
1.	Teacher- Student ratio	(54/5)=10.80
2.	Faculty Cadre Ratio	Professors : 0 Associate Professors: 2 Assistant Professors: 3
3.	Faculty Qualifications	Ph.D's:1 Pursuing Ph.D:1 All the other faculty have M.Tech /M.E/
4.	Faculty contribution in writing:	Books:1 Chapters:4
5.	Awards/Rewards received:	Faculty Received Awards from various organizations: Dr. S. Rangaswamy : 2
6.	Faculty in professional organizations:  And faculty contribution:	ISTE : 1 IAENG :5 SDIWC : 3
7.	National level events organized -Conferences: -Workshops/ Seminars: -FDPs:	EVENTS ORGANISED FDP: 2 WORKSHOPS : 3 SEMINARS: 1
8.	List of Conferences/seminars/ workshops / FDP's/ any exclusive programs attended for enrichment of teaching - learning process	FDP:5 WORKSHOP : 1 CONFERENCES: 2
9.	Faculty interaction with outside world (BOS/NBA/Examiner for PhD evaluation / selection committee / Academic auditing /Chief guest /etc. )	Faculty members who acted as Resource Persons/Judges/Speakers/BOS: 1



*[Handwritten signature]*

PRINCIPAL

Vignan's Institute of Management & Technology For Women  
Kondapur (V), Ghatkesar (M), Medchal-Malkajgiri (Dt)-501301  
Telangana State





# VIGNAN'S INSTITUTE OF MANAGEMENT AND TECHNOLOGY FOR WOMEN

(Sponsored by Lavu Educational Society)

[Affiliated to JNTUH, Hyderabad & Approved by AICTE, New Delhi]

Kondapur (V), Ghatkesar (M), Medchal - Malkajgiri (D) - 501 301. Phone: 96529 10002/3



10.	Faculty Load	Faculty load is distributed as per AICTE Norms.  HOD: 10 HOURS/WEEK PROFESSOR: 8-12 HOURS/WEEK ASSOC.PROF: 12-16 HOURS/WEEK ASSISTANT PROF.: 16-20 HOURS/WEEK Details are made available in Work Load Particular file.
-----	--------------	--

### III. Teaching-Learning Process and Evaluation

S. No	Parameter	Observations
1.	Student performance indices Attendance ,Exams	Detained List: NIL Result Analysis : (PASS PERCENTAGE): II-I : 48.15 II-II :87.04
2.	Mechanism and activities for slow learners for their improvement and outcomes.	Remedial classes were conducted for slow learners based upon their performance in Mid examination. Remedial classes details are maintained in Remedial Classes file.
3.	Student counseling/ mentoring mechanism	One faculty mentor attached to 20 students from II B. Tech to look after the career, academic and personal problems. Details of every student is maintained in Student Mentor Book.
4.	Tutorial classes	Tutorials were conducted as per curriculum and sheets are available in faculty course files. Tutorial Hours also specified in regular Time Table.
5.	Initiatives taken for innovative mini and major projects -Training for students & faculty	As the Students are in 2 <sup>nd</sup> Year No Such events are initiated.
6.	Best student projects with awards.	NA



*[Signature]*

PRINCIPAL

Vignans Institute of Management & Technology For Women  
Kondapur (V), Ghatkesar (M), Medchal-Malkajgiri (Dt)-501301  
Telangana State



# VIGNAN'S INSTITUTE OF MANAGEMENT AND TECHNOLOGY FOR WOMEN

(Sponsored by Lavu Educational Society)  
[Affiliated to JNTUH, Hyderabad & Approved by AICTE, New Delhi]

Kondapur (V), Ghatkesar (M), Medchal - Malkajgiri (D) - 501 301. Phone: 96529 10002/3



7.	Monitoring of teaching--learning process -- Assessment of teaching process in Classrooms. -- Random verification of evaluated answer papers and question paper during the semester. -- Innovative teaching methods presented if any. -- Verification of course files	1. HOD monitors the lesson plan for every 15 days through attendance register of the students for different subjects and also marks awarded in midterm examinations.  2. Department committee assesses whether faculty are following the bloom's taxonomy and pattern of question papers as per regulations.  3. PPT's and videos, if any, used by faculty are mentioned in course files.  Course files are verified by department and Department IQAC Co-ordinator before finalizing the calculation of CO and PO attainments in every semester. (Maintained in separate files- containing Lesson plans, Student performace, Course Question banks specified with COs , course materials & final assessment of all the students.)
8.	Training programs conducted for students Guest lecturers: Seminars/ workshops:	Training programs Workshops -3 Seminars -1 Guest lectures - NIL
9.	Students feedback	1. Feedback were collected in all the semesters. 2. The feedback reports are available in the file. 3. The follow up action is to be initiated only for that faculty who have feedback less than 3 out of 5 scale, as there was no faculty having feedback less than 3 in this academic year. No follow-up action required. <b>Details are maintained in feedback file</b>
10.	Feedback follow-up action	
11.	Scope for Self-learning Certificate courses Online courses	NIL



PRINCIPAL

Vignans Institute of Management & Technology For Women  
Kondapur (V), Ghatkesar (M), Medchal-Malkajgiri (Dt)-501301  
Telangana State



# VIGNAN'S INSTITUTE OF MANAGEMENT AND TECHNOLOGY FOR WOMEN

(Sponsored by Lavu Educational Society)

[Affiliated to JNTUH, Hyderabad & Approved by AICTE, New Delhi]

Kondapur (V), Ghatkesar (M), Medchal - Malkajgiri (D) - 501 301. Phone: 96529 10002/3



12.	Placements (%): Industries / Organizations:	NA
13.	Higher studies (%): Institutions:	NA

## IV. Research, Consultancy and Extension

Sl.No	Parameter	Observations
1.	Faculty publications in journals: Peer reviewed Journals:	International Journals : 4 National Journals : NIL Scopus Indexed : NIL SCI Indexed : 2 <b>Details are also Maintained in separate file-Publication File</b>
2.	Publications in conferences: - National: - International:	National : 0 International : 2  <b>Details are also Maintained in separate file-Publication File</b>
3.	PhDs -Registered: Submitted: Awarded:  PhDs guiding /guided:	PhDs -Registered : 0 Submitted : 0 Awarded : 0  PhDs guiding /guided:NIL
4.	Funded R&D projects and Consultancy work Applied: Ongoing: Completed:	Applied : 2 Ongoing : NIL Completed : 1
5.	Faculty intellectual property rights	IPR : 4 PATENTS



  
PRINCIPAL

Vignan's Institute of Management & Technology For Women  
Kondapur (V), Ghatkesar (M), Medchal-Malkajgiri (Dt)-501301  
Telangana State



# VIGNAN'S INSTITUTE OF MANAGEMENT AND TECHNOLOGY FOR WOMEN

(Sponsored by Lavu Educational Society)

[Affiliated to JNTUH, Hyderabad & Approved by AICTE, New Delhi]

Kondapur (V), Ghatkesar (M), Medchal - Malkajgiri (D) - 501 301. Phone: 96529 10002/3



6.	MOU's with industries/ R&D/ Premier institutes	MOU's with Industries : 1 R&D : NIL Premier Institutes : NIL
7.	Research centers of excellence established:  Outcome in research centers:	NIL
8.	Faculty involved in research and Consultancy.	Number of faculty involved in research and Consultancy : 1



PRINCIPAL

Vignans Institute of Management & Technology For Women  
Kondapur (V), Ghatkesar (M), Medchal-Malkajgiri (Dt)-501301  
Telangana State



# VIGNAN'S INSTITUTE OF MANAGEMENT AND TECHNOLOGY FOR WOMEN

(Sponsored by Lavu Educational Society)

[Affiliated to JNTUH, Hyderabad & Approved by AICTE, New Delhi]

Kondapur (V), Ghatkesar (M), Medchal - Malkajgiri (D) - 501 301. Phone: 96529 10002/3



## V. Infrastructure and Learning Resources

Sl. No	Parameter	Observations
1.	Adequacy of infrastructural facilities to improve the teaching learning process Class rooms: Laboratories: ICT class rooms / e- Class Rooms: Seminar halls: Faculty rooms:	Class rooms : 2 Laboratories : 2 E-Class room : 1 Seminar halls : 1 Faculty Rooms : 1
2.	Internet facilities for faculty & Students:	1. Wi-Fi facility also provided to Staff and Students Laptops. 2. Internet facility provided to all computers in Laboratories. 3. Department Office and Staff rooms are having internet by LAN and Wi-Fi.
3.	Technical manpower support	Programmer -5 Hardware Mechanic -1 Lab. Technician -1 Office .Assistant -NIL Training Assistant -1 Total manpower support - 8
4.	Modern / new equipment added in laboratories	NIL
5.	Details of computing facilities and Improvement.	All the Labs are equipped with adequate computing facilities as needed.
6.	Department level library resources with Details.	Text books -- 30 Digital Library: Can access through LAN



PRINCIPAL

Vignani's Institute of Management & Technology For Women  
Kondapur (V), Ghatkesar (M), Medchal-Malkajgiri (Dt)-501301  
Telangana State



# VIGNAN'S INSTITUTE OF MANAGEMENT AND TECHNOLOGY FOR WOMEN

(Sponsored by Lavu Educational Society)

[Affiliated to JNTUH, Hyderabad & Approved by AICTE, New Delhi]

Kondapur (V), Ghatkesar (M), Medchal - Malkajgiri (D) - 501 301. Phone: 96529 10002/3



## VI. Student information, Support and Progression

Sl. No	Parameter	Observations
1.	Add-on courses:	Add-on Courses: 2  Details on Add-on Courses are maintained in a file.
2.	Student prizes: Scholarships Dept. Student clubs:	1. Student Prizes - 1 2. Scholarship - 3. Department student clubs - 2
3.	Details of coaching provided for GATE/GRE/any other Competitive Exams.	As the students are in 2 <sup>nd</sup> Year only CRT related programs were initiated.
4.	Internships	Internships -- NIL



  
PRINCIPAL  
Vignan's Institute of Management & Technology For Women  
Kondapur (V), Ghatkesar (M), Medchal-Malkajgiri (Dt)-501301  
Telangana State



## VII. Governance, Leadership and Management

Sl. No	Parameter	Observations
1.	Teaching and Non-Teaching staff attended for skill development programs.	Teaching staff: 3 Non-teaching staff: NIL
2.	MoUs with premier Institutions for knowledge exchange.	1
3.	Quality policy & Quality objectives Committees & duties: Cells & duties:	IQAC is monitoring the Quantitative and Qualitative measures.
4.	Maintenance factor -physical observation -Biometric -Attendance monitoring system	1. Attendance register (physical) is maintained for faculty. It is countersigned by Principal daily. 2. Student's attendance is monitored daily and absentee's information is sent to their parents through SMS. 3. Attendance registers of the students (physical) is maintained and countersigned by HOD regularly. 4. The Students having less than 75% attendance information is maintained and informed to the parents periodically. <b>(Registers are maintained in Department office)</b>
5.	Financial support/leaves for qualification/skill up- gradation:	Financial incentive is being given for publishing papers in peer reviewed journals and for attending the FDP, Conferences. File related to this is maintained in the Department.
6.	Risk evaluation/safety measures:	Safety measures are disseminated in all the laboratories. Fire Extinguishers are provided in all laboratories.



*[Handwritten Signature]*

PRINCIPAL

Vignan's Institute of Management & Technology For Women  
Kondapur (V), Ghatkesar (M), Medchal-Malkajgiri (Dt)-501301  
Telangana State



# VIGNAN'S INSTITUTE OF MANAGEMENT AND TECHNOLOGY FOR WOMEN

(Sponsored by Lavu Educational Society)

[Affiliated to JNTUH, Hyderabad & Approved by AICTE, New Delhi]



Kondapur (V), Ghatkesar (M), Medchal - Malkajiri (D) - 501 301. Phone: 96529 10002/3



## 1. Suggestions for improvement:

1. DST Projects to be applied.
2. Improvement needed in books and conference proceedings.
3. Enhance quality publications.
4. Collaborative initiatives to be improved.

Sign of Department Coordinator:   
(V. Madhulata Reddy)

Sign of Academic Auditors 1.   
(K. Helini)  
2.   
(Dr. P. Rajendra Reddy)  
3.   
(Dr. V. Sroja)

Sign of HOD:   
(CDR. S. RANGA SWAMY)  
Head of the Department

Computer Science and Engineering (AI & ML)  
Vignani's Institute of Management & Technology For Women  
Kondapur (V), Ghatkesar (M), Medchal-Malkajiri (Dt)-501301

Sign of IQAC Coordinator:   
(G. Rajesh)

Co-ordinator  
Internal Quality Assurance Cell  
Vignani's Institute of Management & Technology For Women  
Kondapur (V), Ghatkesar (M), Medchal-Malkajiri (Dt)-501301  
Telangana State





PRINCIPAL  
Vignani's Institute of Management & Technology For Women  
Kondapur (V), Ghatkesar (M), Medchal-Malkajiri (Dt)-501301  
Telangana State





**INTERNAL QUALITY ASSURANCE CELL**

**ACADEMIC & ADMINISTRATIVE AUDIT  
REPORT**

**Evaluation Sheet**

Department Name : **Electronics and Communication Engineering**  
Programme Name : **B. Tech**  
Academic Year : **2021-22**

<b>I. PSOs, POs and Curriculum</b>		
<b>S.No</b>	<b>Parameter</b>	<b>Observations</b>
1.	PSO's and POs attainment.	PO attainments were calculated. Details are made available in Department file.
2.	PAC/DAC meetings	PAC meeting was conducted on : 21-08-2021. DAC meeting was conducted on: 28-08-2021. DAC meeting was conducted on: 21-02-2022. Files are available in the department
3.	Stakeholder's feedback and evidence related to curriculum design.	Stake holders feedbacks were collected and analyzed.  Details are maintained in a separate file.
4.	Percentage of lab component	Percentage of Lab Component: Based on number of Subjects:46.42 Based on number of Credits:15.38 Based on number of Contact Hours:27.65



*[Signature]*

PRINCIPAL

Vignans Institute of Management & Technology For Women  
Kondapur (V), Ghatkesar (M), Medchal-Malkajiri (Dt)  
Pin-501301, T.S.  
Tatangana Street



# VIGNAN'S INSTITUTE OF MANAGEMENT AND TECHNOLOGY FOR WOMEN

Sponsored by Lavu Educational Society, Approved by AICTE, New Delhi & Affiliated to JNTUH, Hyderabad.  
Kondapur (V), Ghatkesar (M), Medchal - Malkajgiri (D) - 501 301 Phone: +91 96529 10002/3



## II. Faculty information and their contribution

S. No	Parameter	Observations
1.	Teacher- Student ratio	(297/21)=14.14
2.	Faculty Cadre Ratio	Professors : 3 Associate Professors: 5 Assistant Professors: 14
3.	Faculty Qualifications	Ph.D's:4 Pursuing Ph.D:4 All the other faculty have M.Tech /M.E/:14
4.	Faculty contribution in writing:	Books:4 Chapters: 5
5.	Awards/Rewards received:	NIL
6.	Faculty in professional organizations: And faculty contribution:	IETE : 1 ISTE:1 ORCID:21
7.	National level events organized -Conferences: -Workshops/ Seminars: -FDPs: International level events organized -Conferences: -Workshops/Seminars:	EVENTS ORGANISED FDP: 1 WORKSHOPS : 0 SEMINARS: 3
8.	List of Conferences/seminars/ workshops / FDP's/ any exclusive programs attended for enrichment of teaching - learning process	FDP: 7 WORKSHOP : 4 CONFERENCES: 2
9.	Faculty interaction with outside world (BOS/NBA/Examiner for PhD evaluation / selection committee / Academic auditing /Chief guest /etc.)	NIL
10.	Faculty Load	Faculty load is distributed as per AICTE Norms. Work Load Particular file is available. HOD: 10 HOURS/WEEK PROFESSOR: 8-12 HOURS/WEEK ASSOC.PROF: 12-16 HOURS/WEEK ASSISTANT PROF.: 16-20 HOURS/WEEK



  
PRINCIPAL

Vignans Institute of Management & Technology For Women  
Kondapur (V), Ghatkesar (M), Medchal-Malkajgiri (Dt)-501301  
Telangana State



### III. Teaching-Learning Process and Evaluation

S. No	Parameter	Observations
1.	Student performance indices Attendance ,Exams	Detained List: II-I:1 Result Analysis : (PASS PERCENTAGE): II-I : 52.63 II-II : 72.37 III-I:62.00 III-II:50.00 IV-I:72.32 IV-92.86
2.	Mechanism and activities for slow learners for their improvement and outcomes	Remedial classes were conducted for slow learners based upon their performance in Mid examination. Remedial classes details are maintained in Remedial Classes file.
3.	Student counseling/ mentoring mechanism	One faculty mentor attached to 20 students from II ,III B. Tech to look after the career, academic and personal problems. Details of every student is maintained in Student Mentor Book.
4.	Tutorial classes	Tutorials were conducted as per curriculum and sheets are available in faculty course files. Tutorial Hours also specified in regular Time
5.	Initiatives taken for innovative mini and major projects -Training for students & faculty	Workshops and Seminars were organized. Details are maintained in a file.
6.	Best student projects with awards.	<b>2 Projects were selected.</b> <b>Details are available in project file.</b>



  
PRINCIPAL  
Vignan's Institute of Management & Technology For Women  
Kondapur (V), Ghatkesar (M), Medchal-Malkajgiri (Dt)-501301  
Telangana State



# VIGNAN'S INSTITUTE OF MANAGEMENT AND TECHNOLOGY FOR WOMEN

Sponsored by Lavu Educational Society, Approved by AICTE, New Delhi & Affiliated to JNTUH, Hyderabad.  
Kondapur (V), Ghatkesar (M), Medchal - Malkajgiri (D) - 501 301 Phone: +91 96529 10002/3



7.	<p>Monitoring of teaching--learning process</p> <ul style="list-style-type: none"><li>-- Assessment of teaching process in Classrooms.</li><li>-- Random verification of evaluated answer papers and question paper during the semester.</li><li>-- Innovative teaching methods presented if any</li><li>-- Verification of course files</li></ul>	<p>HOD monitors the lesson plan for every 15 days through attendance register of the students for different subjects and also marks awarded in midterm examinations.</p> <p>Department committee assesses whether faculty are following the bloom's taxonomy and pattern of question papers as per regulations.</p> <p>PPT's and videos, if any, used by faculty are mentioned in course files.</p> <p>Course files are verified by department and Department IQAC Co-ordinator before finalizing the calculation of CO and PO attainments in every semester. (Maintained in separate files- containing Lesson plans, Student performance, Course Question banks specified with COs , course materials &amp; final assessment of all the students.)</p>
8.	<p>Training programs conducted for students Guest lecturers: Seminars/ workshops:</p>	<p>Training programs Workshops -5 Seminars/ Guest lectures -2</p>
9.	<p>Students feedback</p>	<p>1. Feedback were collected in all the semesters. 2. The feedback reports are available in the file. 3. The follow up action is to be initiated only for that faculty who have feedback less than 3 out of 5 scale, as there was no faculty having feedback less than 3 in this academic year. No follow-up action required. Details are maintained in feedback file</p>
10.	<p>Feedback follow-up action</p>	



PRINCIPAL

Vignans Institute of Management & Technology For Women  
Kondapur (V), Ghatkesar (M), Medchal-Malkajgiri (Dt)-501301  
Telangana State



# VIGNAN'S INSTITUTE OF MANAGEMENT AND TECHNOLOGY FOR WOMEN

Sponsored by Lavu Educational Society, Approved by AICTE, New Delhi & Affiliated to JNTUH, Hyderabad.  
Kondapur (V), Ghatkesar (M), Medchal - Malkajgiri (D) - 501 301 Phone: +91 96529 10002/3



11.	Scope for Self-learning Certificate courses Online courses	COURSERA No. of faculty Certified : NIL No. of Students Certified : 14
12.	Placements (%): Industries / Organizations:	No. of Students:112 No. of Students Placed : 96
13.	Higher studies (%): Institutions:	Students Higher studies: 4 Total No. of Institutions :4 <b>(Details are maintained in Higher Studies File)</b>

## IV. Research, Consultancy and Extension

Sl.No	Parameter	Observations
1.	Faculty publications in journals: Peer reviewed Journals:	International Journals : 10 National Journals : NIL Scopus Indexed : 7 SCI Indexed : 0 <b>Details are also Maintained in separate file-Publication File</b>
2.	Publications in conferences: - National: - International:	National : 0 International : 4 <b>Details are also Maintained in separate file-Publication File</b>
3.	PhDs -Registered: Submitted: Awarded:  PhDs guiding /guided:	PhDs -Registered : 1 Submitted : 0 Awarded : 1  PhDs guiding /guided: NIL
4.	Funded R&D projects and Consultancy work Applied: Ongoing: Completed:	Applied : 2 Ongoing : NIL Completed : 2



  
PRINCIPAL

Vignans Institute of Management & Technology For Women  
Kondapur (V), Ghatkesar (M), Medchal-Malkajgiri (Dt)-501301  
Telangana State



# VIGNAN'S INSTITUTE OF MANAGEMENT AND TECHNOLOGY FOR WOMEN

Sponsored by Lavu Educational Society, Approved by AICTE, New Delhi & Affiliated to JNTUH, Hyderabad.  
Kondapur (V), Ghatkesar (M), Medchal - Malkajgiri (D) - 501 301 Phone: +91 96529 10002/3



5.	Faculty intellectual property rights	IPR : PATENTS - 7
6.	MOU's with industries/ R&D/ Premier institutes	MOU's with Industries : 3 R&D : 2 Premier Institutes : nil
7.	Research centers of excellence established:  Outcome in research centers:	NIL
8.	Faculty involved in research and Consultancy.	Number of faculty involved in research and Consultancy :3



PRINCIPAL

Vignan's Institute of Management & Technology For Women  
Kondapur (V), Ghatkesar (M), Medchal-Malkajgiri (Dt)-501301  
Telangana State



# VIGNAN'S INSTITUTE OF MANAGEMENT AND TECHNOLOGY FOR WOMEN

Sponsored by Lavu Educational Society, Approved by AICTE, New Delhi & Affiliated to JNTUH, Hyderabad.  
Kondapur (V), Ghatkesar (M), Medchal - Malkajgiri (Dt) - 501 301 Phone: +91 96529 10002/3



## V. Infrastructure and Learning Resources

Sl. No	Parameter	Observations
1.	Adequacy of infrastructural facilities to improve the teaching learning process Class rooms: Laboratories: ICT class rooms / e- Class Rooms: Seminar halls: Faculty rooms:	Class rooms : 5 Laboratories : 13 E-Class room : 1 Seminar halls : 1 Faculty Rooms : 1
2.	Internet facilities for faculty & Students:	Wi-Fi facility also provided to Staff and Students Laptops. Internet facility provided to all computers in Laboratories. Department Office and Staff rooms are having internet by LAN and Wi-Fi.
3.	Technical manpower support	Lab Assistant -7 Lab. Technician -1 Total manpower support -8
4.	Modern / new equipment added in laboratories	22-Components are added in ADE lab
5.	Details of computing facilities and Improvement.	All the Labs are equipped with adequate computing facilities as needed.
6.	Department level library resources with Details.	Text books - 178 Digital Library: Can access through LAN



PRINCIPAL

Vignani's Institute of Management & Technology For Women  
Kondapur (V), Ghatkesar (M), Medchal-Malkajgiri (Dt)-501301  
Telangana State



# VIGNAN'S INSTITUTE OF MANAGEMENT AND TECHNOLOGY FOR WOMEN

Sponsored by Lavu Educational Society, Approved by AICTE, New Delhi & Affiliated to JNTUH, Hyderabad.  
Kondapur (V), Ghatkesar (M), Medchal - Malkajiri (D) - 501 301 Phone: +91 96529 10002/3



VI. Student information, Support and Progression		
Sl. No	Parameter	Observations
1.	Bridge courses: Add-on courses:	Add-on Courses: 4 Details on Add-on Courses are maintained in a file.
2.	Student prizes: Scholarships Dept. Student clubs:	Student Prizes - 6 Scholarship - 4 Department student clubs - 3
3.	Details of coaching provided for GATE/GRE/any other Competitive Exams.	CRT related programs were initiated. Company Specific Training is proposed in the final year.
4.	Internships	Internships - 78



PRINCIPAL

Vignans Institute of Management & Technology For Women  
Kondapur (V), Ghatkesar (M), Medchal-Malkajiri (Dt)-501301  
Telangana State





## VII. Governance, Leadership and Management

Sl. No	Parameter	Observations
1.	Teaching and Non-Teaching staff attended for skill development programs	Teaching staff: 1 Non-teaching staff: 1 NPTEL online Certificate courses no of faulty certified: NIL
2.	MoUs with premier Institutions for knowledge exchange	1
3.	Quality policy & Quality objectives Committees & duties: Cells & duties:	IQAC is monitoring the Quantitative and Qualitative measures.
4.	Maintenance factor -physical observation -Biometric -Attendance monitoring system	1. Attendance register (physical) is maintained for faculty. It is countersigned by Principal daily. 2. Student's attendance is monitored daily and absentee's information is sent to their parents through SMS. 3. Attendance registers of the students (physical) is maintained and countersigned by HOD regularly. 4. The Students having less than 75% attendance information is maintained and informed to the parents periodically. <b>(Registers are maintained in Department office)</b>
5.	Financial support/leaves for qualification/skill up- gradation	Financial incentive is being given for publishing papers in peer reviewed journals and for attending the FDP, Conferences. File related to this is maintained in the Department.
6.	Risk evaluation/safety measures:	Safety measures are disseminated as Fire Extinguishers are provided in all laboratories.



  
PRINCIPAL

Vignans Institute of Management & Technology For Women  
Kondapur (V), Ghatkesar (M), Medchal-Malkajgiri (Dt)-501301  
Telangana State



# VIGNAN'S INSTITUTE OF MANAGEMENT AND TECHNOLOGY FOR WOMEN

Sponsored by Lavu Educational Society, Approved by AICTE, New Delhi & Affiliated to JNTUH, Hyderabad.  
Kondapur (V), Ghatkesar (M), Medchal - Malkajiri (D) - 501 301 Phone: +91 96529 10002/3



## 1. Suggestions for improvement:

1. Motivation to the faculty for books and conferences is needed.
2. DST Projects should be applied.
3. More students to be involved in Extension activities.

Sign of Department Coordinator:

  
(T. Pullaiah)

Sign of Academic Auditors 1.

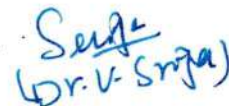
  
(Dr. V. Srjja)

2.   
(R. Helini)

3.   
(Dr. P. Jayendra Prasad)

Sign of HOD :



Head of the Department  
Electronics and Communication Engineering  
Vignani's Institute of Management & Technology For Women  
Kondapur (V), Ghatkesar (M), Medchal-Malkajiri (Dt.)-501301

Sign of IQAC Coordinator:



(G. Rajesh)  
Co-ordinator

Internal Quality Assurance Cell  
Vignani's Institute of Management & Technology For Women  
Kondapur (V), Ghatkesar (M), Medchal-Malkajiri (Dt.)-501301  
Telangana State



  
PRINCIPAL

Vignani's Institute of Management & Technology For Women  
Kondapur (V), Ghatkesar (M), Medchal-Malkajiri (Dt.)-501301  
Telangana State



VIGNAN'S INSTITUTE OF MANAGEMENT AND  
TECHNOLOGY FOR WOMEN

## Carbon Footprint and Energy Audit

## CONTENTS

04 Acknowledgement

05 Executive Summary

07 Carbon footprint & Opportunities

11 Energy efficiency

17 Conclusion



PRINCIPAL

Vignan's Institute of Management & Technology For Women  
Kondapur (V), Ghatkesar (M), Medchal-Malkajiri (Dt)-501301  
Telangana State

# Acknowledgements

REST Pvt Ltd

**Dr Rekhapalli Srinivasa Rao**  
Green, Eco & Energy Lead Auditor  
Certified ISO-14001 Auditor

20 Dec 2021

## Carbon Footprint & Energy Audit

The REST Pvt Ltd acknowledges with thanks the cooperation extended to our team for completing the study at Vignan's Institute of Management and Technology for Women (VMTW)

The interactions and deliberations with VMTW team were exemplary and the whole exercise was thoroughly a rewarding experience for us. We deeply appreciate the interest, enthusiasm, and commitment of VMTW team towards environmental sustainability.

We are sure that the recommendations presented in this report will be implemented and the VMTW team will be further improve their environmental performance.

Kind regards

Your sincerely



**Dr Rekhapalli Srinivasa Rao**

Green, Eco & Energy Lead Auditor  
Certified ISO-14001 Auditor  
REST Pvt Ltd



PRINCIPAL

Vignan's Institute of Management & Technology For Women  
Kondapur (V), Ghatkesar (M), Medchal-Malkajgiri (DI)-501301  
Telangana State

4 Page

# Executive Summary

The growth of countries across the world is leading to increased consumption of natural resources. There is an urgent need to establish environmental sustainability in every activity we do. In a modern economy, environmental sustainability will play a critical role in the very existence of an organization.

An educational institution is no different. Built environment, especially an educational institution, has a considerable footprint on the environment. Impact on the environment due to energy consumption, water usage and waste generation in an educational institute is prominent. Therefore, there is an imminent need to reduce the overall environmental footprint of the institution.

As an Institution of higher learning, West Godavari Institute of Science & Engineering (VMTW) firmly believes that there is an urgent need to address the environmental challenges and improve their environmental footprint.

True to its belief, VMTW has almost 70% transforming conventional bulbs & fixtures into non-conventional energy LEDs. REST Pvt Ltd team congratulates VMTW team for their efforts.

Keeping VMTW work in energy efficiency, we recommend the following to be taken by the competent team at VMTW:

**Work towards achieving carbon neutrality:** NDC emphasizes creating an additional carbon sink of 2.5 to 3 billion tonnes of CO<sup>2</sup> equivalent through additional forest and tree cover by 2030. VMTW's net carbon emission for the year 2020-21 is 107 MT CO<sup>2</sup>e. VMTW should focus on energy efficiency, renewable energy, and carbon sequestration as tools that will enable them to offset the present carbon emissions and achieve carbon neutrality.

**Installation of solar rooftop:** Renewable energy plays a very important role in improving the environmental footprint of an organization. By increasing the share of renewable energy in VMTW's energy portfolio, the overall carbon footprint of the college can be reduced. The roof area available at VMTW is around 83129.68 sq.ft. As an initial step, VMTW could look at installing 25kWp of solar PV which can generate 40,500 units per year. Still the renewable share will also reduce the 140 MT CO<sup>2</sup>e. For the current assessment year power consumption is 50454 units/year. Still another 100kWp of roof top can be utilized for solar power to expand in step VMTW.

**Increase the operating power factor:** Presently, based on the energy bills, it is understood that the institution maintains a power factor of 0.65. Since the institution pays electricity bills for the KVAH consumed, the lower the power factor, higher is the energy bill for the same KWH consumption. It is recommended to install capacitor banks to improve the power factor and save energy bill. VMTW can save up to Rs. 20,000 per month.



  
PRINCIPAL

5 | Page

Vignans Institute of Management & Technology For Women  
Kondapur (V), Ghatkesar (M), Medchal-Malkajgiri (Dt)-501301  
Telangana State

Improve energy efficiency of the college: It is recommended to adopt latest energy efficient technologies for reducing energy consumption in fans, lighting, and air conditioners. We recommend the following projects to be implemented at the earliest:

- Replace conventional 60W ceiling fans with energy efficient BLDC fans of 30W
- Install air conditioners energy savers to save energy in split air conditioners
- Replace all conventional tube lights with LED lamps



PRINCIPAL

Vignan's Institute of Management & Technology For Women  
Kondapur (V), Ghatkesar (M), Medchal-Malkajgiri (D)  
Telangana State

# Carbon Footprint and Energy Audit

Vignan's Institute of Management and Technology for Women (VMTW) and REST Pvt Ltd are working together to identify opportunities for improvement in energy efficiency and carbon reduction. This report highlights all the potential proposals for improvement through the audit and analysis of the data provided by VMTW for lighting, air conditioning, ceiling fans, and biogas potential.

The report also details the carbon emissions from college operations. For carbon emissions, scope 1 and scope 2 emissions are calculated from the data submitted by VMTW. The report emphasizes the GHG emission reduction potential possible through a reduction in power consumption.

Effect of pandemic and online classes on energy consumption and carbon footprint:

The year 2020-21 was affected by the pandemic and because of the pandemic, most of the classes were shifted online. There has been a steady in the consumption of energy in the year 2020-21 around 50454kWH.

Submission of Documents

"Carbon footprint and energy audit at VMTW was carried out with the help of data submitted by VMTW team. VMTW team was responsible for collecting all the necessary data and submitting the relevant documents to REST Pvt Ltd for the study.

Note

Carbon footprint and energy audit are based on the data provided by VMTW team and discussions the REST Pvt Ltd team had with VMTW team. The scope of the study does not include the exclusive verification of various regulatory requirements related to environmental sustainability.

REST Pvt Ltd has the right to recall the study if it finds (a) major violation in meeting the environmental regulatory requirements by the location and (b) occurrence of major accidents, leading to significant damage to ecology and environment.



  
PRINCIPAL  
Vignan's Institute of Management & Technology For Women  
Kondapur (V), Ghatkesar (M), Medchal-Malkajgiri (DI)-501301  
Telangana State



# Opportunities for improvement

As a part of the overall environmental improvement study at VMTW, carbon footprint calculations were also carried out. The objective of calculating the carbon footprint of the campus is find the present level of emissions from campus operation and what initiatives that the VMTW can take to offset the emissions. By offsetting the emissions, the college can become carbon neutral in the future by adopting energy efficient processes, increase in renewable energy share and tree plantation.

Carbon footprint calculations:

To help delineate direct and indirect emission sources, improve transparency, and provide utility for different types of organizations and different types of climate policies and business goals, three "scopes" (scope 1, scope 2, and scope 3) are defined for GHG accounting and reporting purposes.

For calculating carbon footprint of the campus, Scope 1 & Scope 2 emissions are being considered. Since day scholars use college provided transportation and hostellers stay in campus, Scope 1 and Scope 2 are the highest contributor to overall emissions. For this reason, Scope 3 is not being calculated.

Scope 1: Direct GHG Emissions

Direct GHG emissions occur from sources that are owned or controlled by the company, for example, emissions from combustion in owned or controlled DG sets, canteen, vehicles, etc.; emissions from chemical production in owned or controlled process equipment. Direct CO2 emissions from the combustion of biomass shall not be included in scope 1 but reported separately.

VMTW Scope 1 emissions for 2020-21:

Sources of Scope 1 emissions in VMTW:

- 1) Diesel consumption for the generator for the assessment year 2020-21 is 22,627 litres/yr.
- 2) LPG used for canteen/Lab: 240 cylinders/year

Scope 2: Electricity Indirect GHG Emissions

Scope 2 accounts for GHG emissions from the generation of purchased electricity consumed by a college. Purchased electricity is defined as electricity that is purchased or other VMTW brought into the organizational boundary of the college. Scope 2 emissions physically occur at the facility where electricity is generated.

VMTW Scope 2 emissions for 2021: Electricity purchased from grid: 50454Units



  
PRINCIPAL

8 | Page

Vignani's Institute of Management & Technology For Women  
Kondapur (V), Ghatkesar (M), Medchal-Malkajgiri (D)-501301  
Telangana State

### **Develop a roadmap to increase contribution of renewable energy in the overall energy consumption**

To have a continued focus on increasing renewable energy utilization to 100% which will also lead to reduction in GHG emissions, it is suggested to develop a detailed roadmap on RE utilization. The road map should broadly feature the following aspects -

- Renewable energy potential of VMTW and the maximum offset that can be achieved at VMTW
- Percentage substitution with renewable energy that VMTW wants to achieve in a specified time frame

### **Key tasks that need to be executed to achieve the renewable energy target**

- Specific financial break up for each of the projects highlighting the amount required, available and the utilization status as on date
- A regular review mechanism to ensure progress along the lines of the roadmap should be framed
- The roadmap should also highlight important milestones/key tasks, anticipated bottle VMTW & proposed

### **Renewable energy roadmap should be used as a base to frame GHG emissions reduction target**

It is suggested to use the developed renewable energy roadmap to correlate the GHG reduction that each of the renewable energy project will achieve. This approach will provide a base to set targets for reduction in GHG emissions. The action plan for renewable energy will shoulder the action plan for GHG emissions reduction and work towards achieving carbon neutrality.

### **Explore the option of other onsite and offsite renewable energy projects**

The renewable energy field has been witnessing many private investors due its increased market demand and attractive policies in many states. There are Renewable Energy Independent Power Producers (RE IPPs) who have installed RE based power plants like wind, small hydro and solar PV. GOC can consider having a long-term power purchase agreement with these RE IPPs in purchasing fixed quantity of power for a period of 5 to 10 years.

"Evolve a system to monitor the implementation of various GHG mitigation opportunities VMTW has an action plan to reduce its GHG emissions. VMTW should also evolve a system to monitor the implementation of various GHG mitigation opportunities. It is recommended to use a Gantt chart to mark out the action plan for the activities and track its implementation. Gantt chart will serve as an excellent way to instantly monitor and comprehend all different tasks in one place which would ease tracking of implementation.

### **Calculation for Installation of 25 kWp of Solar PV in VMTW campus**

Renewable energy is one of the important steps to be taken up by the college to reduce their overall carbon footprint. Based on the details provided by VMTW team, the roof area available at VMTW is around 83129.68 sq.ft. As an initial step, VMTW could look at installing 25kWp of solar PV which can generate 40,500 units per year. Still the renewable share will also reduce the 140 MT CO<sup>2</sup>e. For the current assessment year power consumption is 50454 units/year. Still another



9 | Page

  
PRINCIPAL  
Vignans Institute of Management & Technology For Women  
Kondapur (V), Ghatkesar (M), Medchal-Malkajgiri (DT)-501301  
Telangana State

100kWp of roof top can be utilized for solar power to expand in stepVMTW. However, for this report calculation, only 25 kWp capacity is considered.

A renewable energy capacity of 25 kW of solar panel may be installed can generate 40,500 units of electricity per year. Additionally, 25 kWp of solar rooftop can offset 33 MT CO<sub>2</sub>e per annum. RESCO model for solar rooftop installation:

A Renewable Energy Service Company (RESCO) is an ESCO Energy service company which provides energy to the consumers from renewable energy sources. RESCO or BOOT model is about pay as Ju consume the electricity.

- Solar Power Plant is owned by the RESCO or Energy Company
- Customer must sign a Power purchase Agreement (PPA) with actual investor at mutually agreed tariff and tenure
- Customer only pays for electricity consumed
- RESCO developer is responsible for its annual operations & maintenance (O&M)
- The RESCO gets the benefit by selling the surplus power generated to the DISCOM



Source: [www.bluebirdsolar.com](http://www.bluebirdsolar.com)



*Adh.*  
PRINCIPAL

Vignani's Institute of Management & Technology For Women  
Kondapur (V), Ghatkesar (M), Medchal-Malkajgiri (Dt)-501301  
Telangana State

# Energy Efficiency

Annual energy consumption of VMTW campus is 50454 units. There are major blocks in the campus which consumes energy for their operation. Major energy consumers are:

1. Fans
2. Air conditioners

## Replace conventional tube lights with LED lamps

## Replace Conventional Ceiling Fans with Energy Efficient BLDC Fans

During the Energy Audit at VMTW, a detailed study was carried out to identify the potential for replacing the existing ceiling fans with BLDC super fans. There are 287 fans operating in VMTW campus.

Instead of conventional ceiling fans, latest technology BLDC fans which consume only 30W can be installed in the newly constructed building. A brushless DC (BLDC) motor is a synchronous electric motor powered by direct-current (DC) electricity and having an electronic commutation system, rather than a mechanical commutator and brushes. A BLDC motor has an external armature called the stator, and an internal armature called the rotor.

The rotor can usually be a permanent magnet. Typical BLDC motor-based ceiling fan has much better efficiency and excellent constant RPM control as it operates out of fixed DC voltage. The proposed BLDC motor and the control electronics operate out of 24V DC through an SMPS having input AC which can vary from 90V to 270V. The operational block diagram of a BLDC motor is as follows:

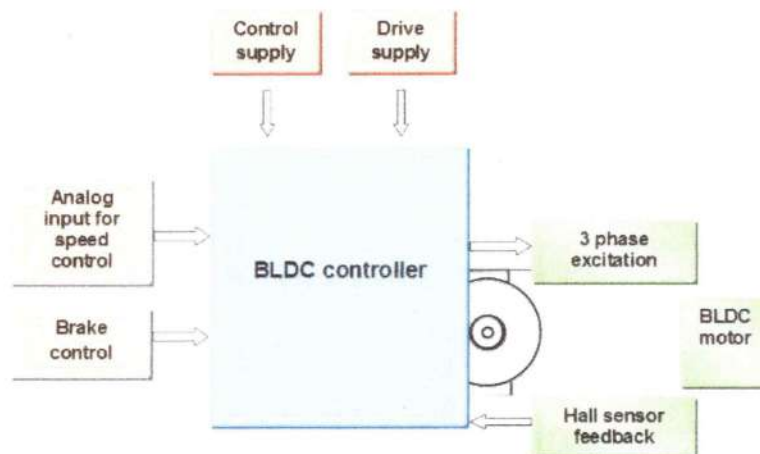

  
PRINCIPAL  
Vignans Institute of Management & Technology For Women  
Kondapur (V), Ghatkesar (M), Medchal-Malkajgiri (DI)-501301  
Telangana State

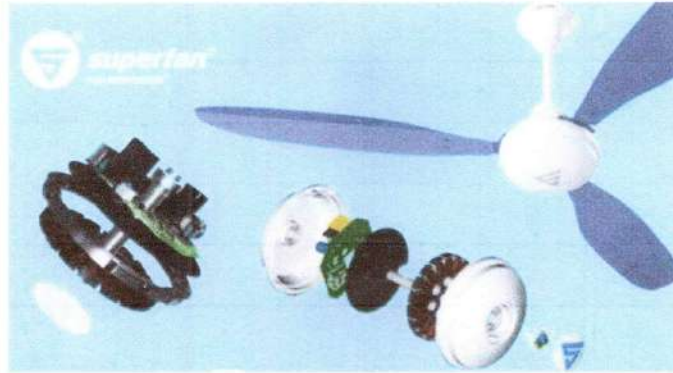

With the replacement of existing ceiling fans with Super Fans the energy consumption is likely to reduce by 55% per fan. Considering 100 fans being replaced with super-efficient BLDC fans, 3.50 kW can be saved. Considering the average operating hours to be 2000 and unit cost as Rs.

7.50, the calculations are as follows:

Total no. of fans in college	:	287
No. of fans considered for calculation	:	100 (First cycle of change)
Energy consumption per fan	:	60W
Total energy consumption of fans	:	60W X 100 fans
	:	6 kW
super-efficient BLDC fans energy consumption:	:	30 W
Savings from 60W to 30 W	:	50%
Total savings in fans energy consumption	:	50% of 6kW
	:	3 kW
Savings per year	:	3kW x 2000 hrs X Rs. 7.50/unit
	:	Rs. 0.45 Lakhs
Investment	:	Rs. 2, 50,000
	:	5.5 months
Annual emission reduction potential	:	6.00 T CO2



  
 PRINCIPAL  
 Vignan's Institute of Management & Technology For Women  
 Kondapur (V), Ghatkesar (M), Medchal-Malkajiri (Dt) 501301  
 Telangana State

**Install Air conditioners energy saver for spilt air conditioners:**

Present status: As per the data obtained from VMTW team, the campus has majorly 1.5 TR units installed. There are 23 spilt air conditioners installed.

**Recommendation:**

We recommend installing "Airtron", an energy saver that can be installed at every individual unit of AC. The Airtron is the world's most advanced AC SAVER, with all the controls of a Precision AC. The Airtron's dual sensors reference the Room and Coil & Ambient Temp, and uses complex, multiple algorithms in a "closed-loop circuit" to reduce the Compressor Run-Time, to ensure the high savings while maintaining and displaying the Set temperature accurately. The Airtron is Programmable for geographical location and climate and adapts automatically to changes in season and ambient conditions.

This unique device has been developed on Patent-Published technology and approved by leading MNC'S, PSU'S and Govt. Departments. The Airtron is validated by EESL (Energy Efficiency Services Ltd.), Ministry of Power, Government of India, for 44% savings. The Airtron has been validated on all AC's- Inverters, 5 Star, Splits, Multi-Splits, Packages, ducts, Windows, Cassettes from 1.0 - 20.0 TR, LG Ltd, Videocon Ltd, Tata Communications, L&T, Nestle, Ashok Leyland etc. The AIRTRON comes with a Remote for setting the Room Temperature, and in a Non-Flammable Polycarbonate Enclosure, with SMPS Power Supply, to tolerate wide Voltage and Current fluctuations, Surges, Spikes and Sags.

In our case, Airtron installation can reduce the energy consumption of each fixture by 15% on a conservative basis. For a total energy consumption, for air conditioners, as 20 units per hour, 3 units per hour can be saved. It is recommended to install Airtron energy saver in a phase VMTW manner preferably in the batches of 10 units.

Saving Calculation: Considering the operating hours to be 2000 and unit cost as Rs 7.50/-.

- Monetary annual savings : Rs 45,000/-
- Total investment : Rs 80,000/-
- Payback period : 22 months (2 years)
- Annual emission reduction potential: 4.92 MT CO2



  
PRINCIPAL  
Vignan's Institute of Management & Technology For Women  
Kondapur (V), Ghatkesar (M), Medchal-Malkajgiri (Dt) 501301  
Telangana State

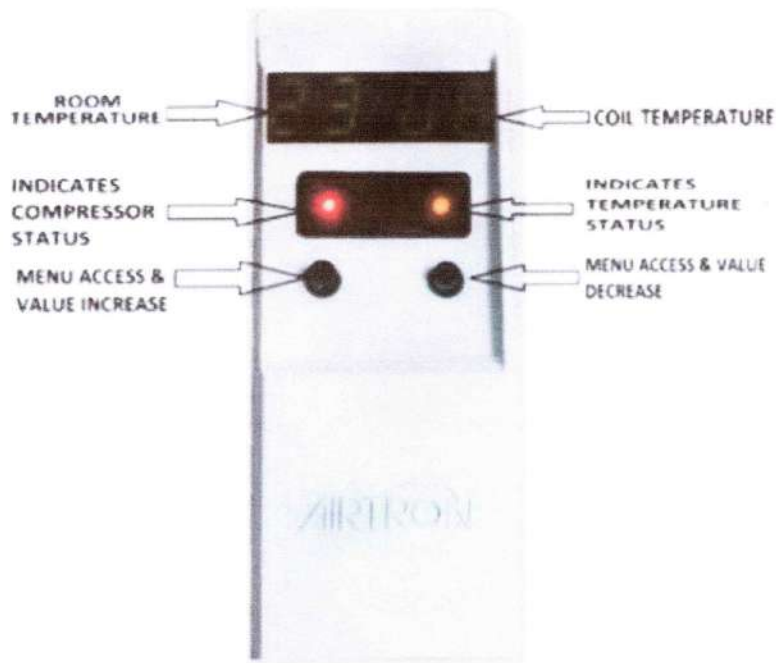

**Replace Conventional Lamps with LED Lamps**

As per the data submitted, the total number of all the lighting fixtures installed are

- 1. LED Tube Lights : 190x20watts = 3,800Watts
- 2. Normal tube lights : 73 x 36watts = 2,628 Watts
- 3. LED bulbs : 04x22Watts = 88Watts
- 4. Normal bulbs : 0

Under failure replacement policy, at least 130 lamps can be changed in the first year.

Types of fixtures	36W Tube
No of fixtures	130
No of hours in Operation	2000



*Handwritten signature* 14 | Page

**PRINCIPAL**  
 Vignans Institute of Management & Technology For Women  
 Kondapur (V), Ghatkesar (M), Medchal-Malkajgiri (Dt)-501301  
 Telangana State

The campus should be keen in harnessing the day lighting available thereby reducing the use of artificial lighting.

Based on the occupancy, monitoring should be ensured to reduce excessive consumption of energy.

Major savings in energy through lighting fixtures can be achieved by replacing all the above existing fixtures with LED's meeting the required LUX levels. The LED's being less energy consuming while maintaining the equivalent lux is the more sustainable option. The replacement of lighting fixtures should be done as per failure replacement policy i.e. change the old fixture with LED when it fails

#### Advantages of LED

- **Lower energy consumption:** The energy consumption of LEDs is low when compared to the other conventional sources for the same amount of Lumen output.

#### Performance comparison of different type lights

Type of Lamp	Lumen/Watt	CRI	Life hours
HPSV lamps	90-120	Bad (22-25)	15,000-20,000
Metal Halide lamps	65-100	Good (65-90)	18,000
LED lamps	100-150	Very Good (>80)	10,000-12,000

- **High S/P ratio:** LEDs have higher scotopic/photopic ratio (S/P ratio). The eye has two primary light sensing cells called rods and cones - cones function in day light and process visual information whereas rods function in night light. The cone dominated vision is called photopic and the rod dominated vision is called scotopic. The S/P ratio indicates the measure of light that excites rods compared to the light that excites cones. In office environments, illumination is more effective if the S/P ratio is high as it is under scotopic region. LEDs hence are ideally suited for these applications as they have a high S/P ratio.
- **Longer life-time:** LEDs have longer life time of around 1,00,000 hours. This is equivalent to 11years of continuous operation or 22 years of 50% operation.
- **Faster switching:** LED lights reach its brightness instantly upon switching and can frequently be switched on/off without reducing the operational life expectancy.



15 | Page  
PRINCIPAL  
Vignans Institute of Management & Technology For Women  
Kondapur (V), Ghatkesar (M), Medchal-Malkajgiri (Dt)-501301  
Telangana State



- **Greater durability and reliability:** As LEDs are solid-state devices and uses semi-conductor material; they are sturdier than conventional sources that use filaments or glass. LEDs can also withstand shock, extreme temperatures and vibration as they don't have fragile materials as components.
- **Good Colour Rendering Index (CRI):** The colour rendering index, i.e., measure of a light sources' ability to show objects as perceived under sunlight is high for LEDs. The CRI of natural sunlight is 100 and LEDs offer CRI of 80 and above.

LED offers more focused light and reduced glare. Moreover, it does not contain pollutants like mercury. LED technology is highly compatible for solar lighting as low-voltage power supply is enough for LED illumination.

Calculations are as follows:

Existing Lighting fixtures	36W
Existing power consumption(kW)	4.5kW (130lamps)
Proposed LED wattage (W)	15
LED power consumption (kW)	1.95kW
Energy saving (kW)	2.55kW
Operating hours	2000

Annual monetary savings : Rs 38,250/-  
 Investment needed : Rs 90,000/-  
 Payback period : 2.5 years  
 Annual Emission reduction potential : 4.18MT of CO2.



*[Signature]*  
 PRINCIPAL  
 Vignani's Institute of Management & Technology For Women  
 Kondapur (V), Ghatkesar (M), Medchal-Malkajgiri (Dt)-501301  
 Telangana State

# Conclusion

VMTW has initiated few energy efficiency activities in their campus. While REST Pvt Ltd appreciates the VMTW team for their efforts, we would like to emphasize that opportunity exists further reduce the energy consumption. Installation of renewable energy is to be given major focus. RESCO model can be adopted to install renewable energy without upfront capital investment. We in REST Pvt Ltd are sure that all the recommendations mentioned in the report will be implemented by VMTW team and the overall environmental performance of the campus will be improved.



PRINCIPAL

Vignans Institute of Management & Technology For Women  
Kondapur (V), Ghatkesar (M), Medchal-Malkajgiri (Dt),  
Telangana State

## CERTIFICATE OF COMPLETION

*This is to certify that*

*Vignan's Institute of Management and Technology for  
Women*

*has successfully completed*

**CARBON FOOTPRINT & ENERGY AUDIT**

The study was completed by Rekhapalli Environmental Solutions &  
Technologies Pvt Ltd



**Dr Rekhapalli Srinivasa Rao**

*Green, Eco & Energy Lead Auditor  
Certified ISO-14001 Auditor*

Issued by

**Rekhapalli Environmental Solutions & Technologies Pvt Ltd**



December 2021



*Principal*  
PRINCIPAL

Vignan's Institute of Management & Technology For Women  
Kondapur (V), Ghatkesar (M), Medchal-Malkajgiri (D)-501301  
Telangana State



VIGNAN'S INSTITUTE OF MANAGEMENT AND  
TECHNOLOGY FOR WOMEN

Environmental Audit  
(Water & Waste Management)

## CONTENTS

04 Acknowledgement

05 Executive Summary

07 Environmental Audit

08 Water & Waste Management

09 Recommendations

20 Conclusion



  
PRINCIPAL

Vignani's Institute of Management & Technology For Women  
Kondapur (V), Ghatkesar (M), Medchal-Malkajgiri (Dt)-501301  
Telangana State

# Acknowledgements

REST Pvt Ltd

**Dr Rekhapalli Srinivasa Rao**  
Green, Eco & Energy Lead Auditor  
Certified ISO-14001 Auditor

20 Dec 2021

## Environmental Audit (Water & Waste Management)

The REST Pvt Ltd acknowledges with thanks the cooperation extended to our team for completing the study at Vignan's Institute of Management and Technology for Women (VMTW).

The interactions and deliberations with VMTW team were exemplary and the whole exercise was thoroughly a rewarding experience for us. We deeply appreciate the interest, enthusiasm, and commitment of VMTW team towards environmental sustainability.

We are sure that the recommendations presented in this report will be implemented and the VMTW team will be further improve their environmental performance.

Kind regards

Your sincerely



**Dr Rekhapalli Srinivasa Rao**  
Green, Eco & Energy Lead Auditor  
Certified ISO-14001 Auditor  
REST Pvt Ltd

PRINCIPAL  
Vignan's Institute of Management & Technology For Women  
Kondapur (V), Ghatkesar (M), Medchal-Malkajgiri (Dt)-501301  
Telangana State

# Executive Summary

The growth of countries across the world is leading to increased consumption of natural resources. There is an urgent need to establish environmental sustainability in every activity we do. In a modern economy, environmental sustainability will play a critical role in the very existence of an organization.

An educational institution is no different. Built environment, especially an educational institution, has a considerable footprint on the environment. Impact on the environment due to energy consumption, water usage and waste generation in an educational institute is prominent. Therefore, there is an imminent need to reduce the overall environmental footprint of the institution.

As an Institution of higher learning, Vignan's Institute of Management and Technology for Women (VMTW) firmly believes that there is an urgent need to address the environmental challenges and improve their environmental footprint.

True to its belief, VMTW has installed solar panel and implemented rainwater harvesting in the campus. Continuing with rainwater harvesting, the college can also investigate the following recommendations:

- **Attain water positive status:** VMTW should focus on capturing the harvested rainwater to substitute freshwater consumption, work on sustainable groundwater beyond the fence and create a framework towards attaining water positive status over a period. Presently, VMTW is consuming nearly 5000 lt of fresh water per day. Since metering is not available, the water consumption is calculated rather than measure value. The first step is to increase the water conservation activities in the campus to reduce water consumption at source. The next step is to increase the rainwater harvesting capacity to completely offset the freshwater requirements of the plant. VMTW can also explore adopting lakes, desilting of ponds and restoration of water bodies in localities surrounding the campus. Water getting harvested in those structures can offset the freshwater consumption of the college.
- **Install water efficient fixtures:** The best way to conserve water is at the source. Therefore, VMTW will have to install water efficient fixtures to reduce water consumption. Some of the water efficient fixtures are:
  - Waterless urinals
  - Electronic taps (e-taps)
  - Electronic flush urinals (e-flush)
  - Foam taps
  - Spring loaded push taps
  - Low flush cistern
- **Install sewage treatment plant / rootzone treatment:** VMTW uses more than 5000 lt of fresh water per day. Considering that 3000 lt (least value) of water is being let to drain without



*ASH*  
PRINCIPAL  
Vignan's Institute of Management & Technology For Women  
Kondapur (V), Ghatkesar (M), Medchal-Malkajiri (DI)-501301  
Telangana State

treatment, good opportunity exists to reduce freshwater consumption by treating the sewage water and using the recycled water for gardening and flushing application. Install biogas plant and phytoremediation in series to recycle water and reduce freshwater consumption.

- **Install water flow meters:** Water flow meters are vital in understating the water consumption patterns of the campus. Presently, the water consumption is calculated rather than being measured. Water flow meters gives an accurate status if water consumption in the campus and from the water consumption values, the roadmap for water conservation activities can be prepared.

- **Segregate waste at source:** VMTW has provided bins for waste collection. VMTW must embark on awareness creation methods to increase the effectiveness of collection and provide more bins for proper waste segregation.

- **Maintenance of waste management yard:** The waste management yard is to be maintained just like raw materials storage room. Waste is nothing but a resource in wrong place. Therefore, by maintaining the waste management yard, quality of wastes can be maintained.



  
PRINCIPAL  
Vignans Institute of Management & Technology For Women  
Kondapur (V), Ghatkesar (M), Medchal-Malkajgiri (Dt)-501301  
Telangana State



# Environmental Audit

VMTW and REST are working together to identify opportunities for improvement in water management, and waste management. This report highlights all the potential proposals for improvement through the audit and analysis of the data provided by VMTW for water consumption and waste management. The report details the process conducted for the analysis such as on ground surveys performed for listing the type of water consumers with consumption per year, types of waste generated and disposal mechanisms.

## Submission of Documents

Environmental audit at VMTW was carried out with the help data submitted by VMTW team. VMTW team was responsible for collecting all the necessary data and submitting the relevant documents to REST Pvt Ltd for the study.

## Preliminary Study

After the receipt of documents, a desktop review of the data for quality check, followed by preliminary study was carried out by REST Pvt Ltd. In case of discrepancy/inadequacy/non-clarity of data, REST Pvt Ltd team got in touch with the VMTW team for clarification/additional information.

## Environmental Audit

Data submitted and collected during the visit was used to assess the water and waste management practices of the campus and finally provide necessary recommendation for environmental improvement.

## Note

Environmental audit is based on the data provided by VMTW team. The scope of the study does not include the exclusive verification of various regulatory requirements related to environmental sustainability.

REST Pvt Ltd has the right to recall the study, if it finds (a) major violation in meeting the environmental regulatory requirements by the location and (b) occurrence of major accidents, leading to significant damage to ecology and environment.



  
PRINCIPAL

Vignan's Institute of Management & Technology For Women  
Kondapur (V), Ghatkesar (M), Medchal-Malkajgiri (Dt)-501301  
Telangana State

# Water Conservation

To achieve a water positive status by continuous reduction of freshwater consumption should be the ultimate focus of VMTW. Increased and focused attention should be given to attain water sustainability in future by inculcating the discipline of water conservation.

Fresh water consumption of VMTW : 5000 lt per day

Rainwater harvesting : Carried out for roof area

According to the report, 'Water in India: Situation & Prospects', India is the largest consumer of groundwater in the world with an estimated usage of 230 km<sup>3</sup> per year. Approximately 60 per cent of the demand from agriculture and irrigation, and about 80 per cent of the domestic water demand, is met through groundwater. As per the Department of Drinking Water and Sanitation nearly 90 per cent of the rural water supply is from groundwater sources. This has led to an increased pressure on aquifers and the resulting hydrological imbalance.



  
PRINCIPAL  
Vignans Institute of Management & Technology For Women  
Kondapur (V), Ghatkesar (M), Medchal-Malkajgiri (Dt)-501301  
Telangana State

## Recommendations for water conservation

**1) Waterless urinals:** Waterless urinals look like regular urinals without a pipe for water intake. Men use them normally, but the urinals don't flush. Instead, they drain by gravity. Their outflow pipes conduits to a building's conventional plumbing system. In other words, unlike a composting toilet, which leaves you to deal with your waste, these urinals send the urine to a water treatment plant.

- a. Urine flows into the drain insert of the EcoTrap.
- b. Inside of the EcoTrap the urine moves through a floating layer of proprietary immiscible Blue Seal liquid, which creates a barrier, preventing sewer gases and urine odours from entering the restroom area.
- c. The urine below the Blue Seal barrier overflows into the central tube and travels down into the drain line.

Waterless Urinal

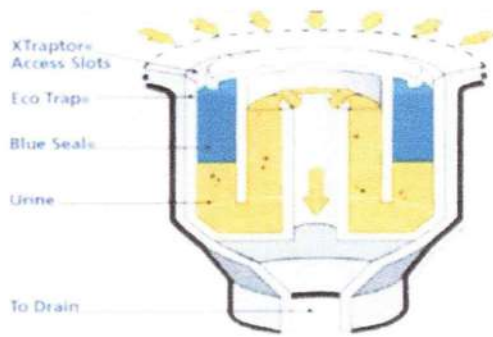

- d. Approximately 1500 sanitary uses are possible with just 3 ounces of BlueSeal. When the BlueSeal liquid is gone, it is simply replenished. This only takes about 20 seconds to perform and the EcoTrap is not touched.
- e. Urine sediments are retained within the EcoTrap. Replacement is easy and need only be done 2 to 4 times per year depending on traffic to the urinal. As tool called the X-Traptor must be used to remove the EcoTrap. The use of the special tool helps to minimize vandalism. The entire process of replacement only takes 3 to 4 minutes.



*Rash*  
PRINCIPAL  
Vignan's Institute of Management & Technology For Women  
Kondapur (V), Ghatkesar (M), Medchal-Malkajiri (Dt)-501301  
Telangana State

Waterless urinals are available for women. Indian manufacturers are supplying waterless urinals technology. Ekameco is one such company providing solution for women waterless urinals. You may visit [www.ekameco.com](http://www.ekameco.com) and mail [info@ekameco.com](mailto:info@ekameco.com) for more details on waterless urinals for women.

2) Volume reduction in flush tanks: One simple method is to add a one-liter equivalent water bottle in the flush tank thereby reducing its consumption majorly. One-liter savings in the tank will help to save approximately by 20% and doesn't require any investment.



3) Rainwater harvesting: Water harvesting or more precisely rainwater harvesting is the technique of collection and storage of rainwater at surface or in subsurface aquifer, before it is lost as surface run off. In artificial recharge, the ground water reservoirs are recharged at a rate higher than natural conditions of replenishment. According to a report by the Central Groundwater Board published in 2007, the selection of a suitable technique for artificial recharge of ground water depends on various factors. They include:

- a) Quantum of non-committed surface runoff available
- b) Rainfall pattern
- c) Land use and vegetation
- c) Topography and terrain profile
- d) Soil type and soil depth
- e) Thickness of weathered / granular zones
- f) Hydrological and hydrogeological characteristics
- g) Socio-economic conditions and infrastructural facilities available
- h) Environmental and ecological impacts of artificial recharge scheme proposed



*ASHA*  
PRINCIPAL  
Vignan's Institute of Management & Technology For Women  
Kondapur (V), Ghatkesar (M), Medchal-Malkajiri (Dt)-501301  
Telangana State

### Rainwater Harvesting Techniques in Urban Area

In urban areas rainwater is available from roof tops of buildings, paved and unpaved areas. This water could be stored and used to replace freshwater as well as used for recharging the aquifer.

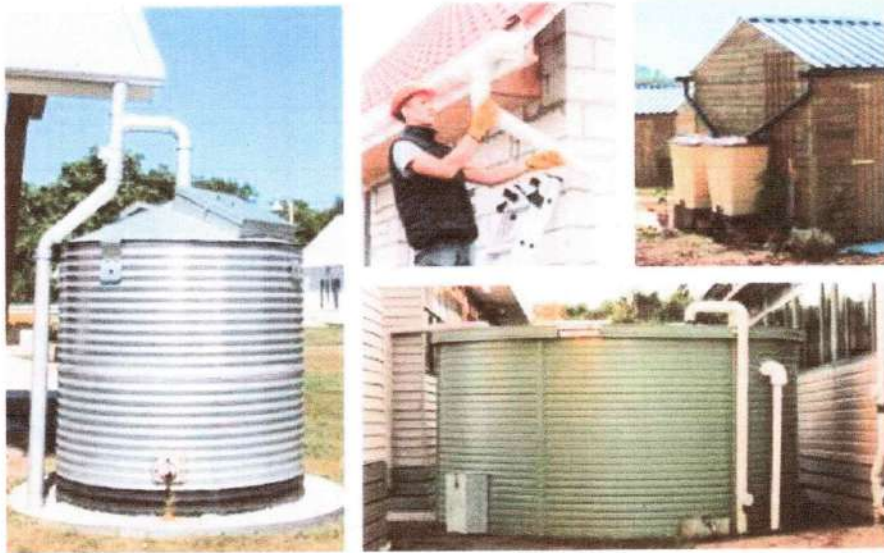

4) Display water balance/conservation status at entrance of all blocks for overall involvement of all students & staff.

It is suggested to display specific water consumption numbers in terms of domestic use at the entrance of each blocks to create awareness among all students and stakeholders visiting the facility. This daily/continuous awareness creation will ultimately help in reduction of water consumption by students.



  
PRINCIPAL  
Vignan's Institute of Management & Technology For Women  
Kondapur (V), Ghatkesar (M), Medchal-Malkajiri (Dt)-501301  
Telangana State

## Water Saving Gadgets

It is suggested to display specific water consumption numbers in terms of domestic use at the entrance of each block to create awareness among all students and stakeholders visiting the facility. This

### Electronic Taps (e-taps)

The latest trend in industries is to install electronic taps (e-taps). The advantages of using e-taps are as mentioned below:

- Unlike conventional taps, there is no twisting or turning in e-taps. They have a sensor, which cuts off water supply completely when not in use. This helps in saving up to 70% water during hand wash.

E-taps enable hands free operation. No fear of cross contamination or contact with germs. E taps score very high on hygiene. It is the most ideal choice for multipurpose and multi-user washrooms.

- E-taps can work efficiently up to raw water TDS of 1,800 ppm.

The touch free electronic taps, available in AC and DC models consume minimal power only. The AC model has an efficient battery back-up, while the DC model runs on just 4 alkaline batteries.

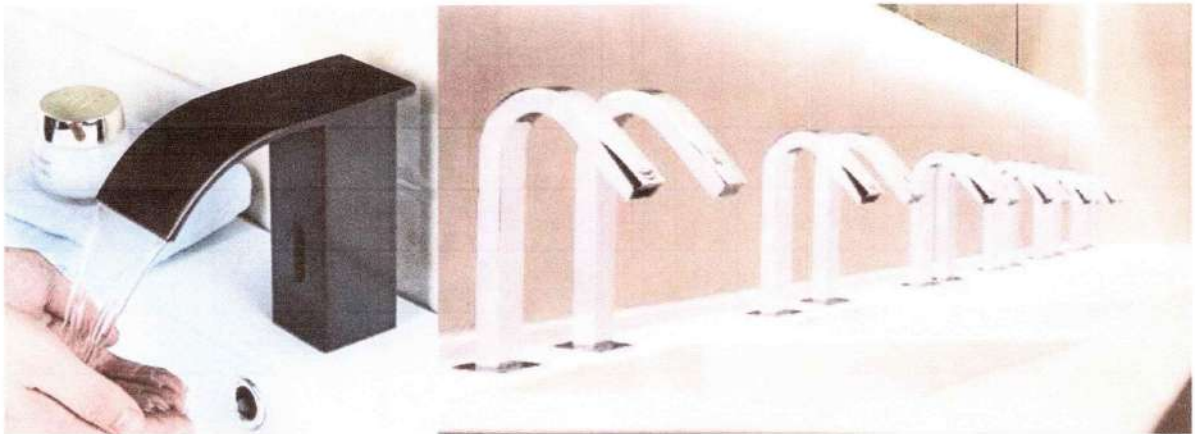

### **Operation of Electronic Taps**

This has been successfully implemented in several hotels & restaurants. Of late, several industries have also started implementing this proposal. Thus, there is a good potential to optimize the Fresh water consumption by replacing the existing taps with e-taps.



  
PRINCIPAL  
Vignan's Institute of Management & Technology For Women  
Kondapur (V), Ghatkesar (M), Medchal-Malkajiri (Dt)-501301  
Telangana State

### Electronic flush (e-flush) urinals

The latest trend in industries is to install e-flush urinals. The advantages of using e-flush urinals are as mentioned below:

- E-flush urinals are fitted with a sensor, which senses the usage and flush with water for few seconds after use. This helps in saving 70% water during urinal flush.
- E-flush urinals enable hands-free operation and score very high on hygiene. It is the most ideal choice for multipurpose and multi-user washrooms.
- E-flush urinals can work efficiently up to raw water TDS of 1,800 ppm.
- The touch free e-flush urinals available in AC and DC models consume minimal power only. The AC model has an efficient battery back-up, while the DC model runs on just 4 alkaline batteries.

Electronic flush urinals



### Hand wash

#### Foam taps

Conventional taps are used in the hand wash areas which results in wastage of large quantities of fresh water. Foam taps are a better fit in these high consumption areas. They consume 25-30% less water than conventional taps.

#### Foam taps

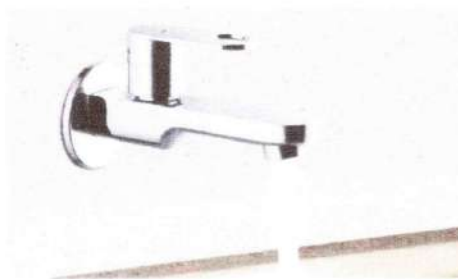

*[Signature]*  
PRINCIPAL  
Vignans Institute of Management & Technology For Women  
Kondapur (V), Ghatkesar (M), Medchal-Malkajgiri (DI)-501301  
Telangana State

### Spring loaded Push taps

Spring loaded push type tap is an alternate device for minimizing hand wash water. The spring-loaded push taps operate with the simple mechanism of pressing the knob for water. The knob is automatically released back to close position in 5-7 seconds. This saves about 30-40% of water compared to the conventional taps.

Spring loaded push taps



### Low flush cistern

The latest model closets are water efficient and operate in dual mode, with a single flush releasing 2 litres of water and the dual flush releasing 4 litres per flush. This results in excellent water savings.

Low flush cisterns



### Install sewage treatment plant - Rootzone treatment:

VMTW uses more than 200 KL of fresh water per day. Considering 150 KL of water is being let to drain without treatment, good opportunity exists to reduce freshwater consumption by treating the sewage water and using the recycled water for gardening and flushing application. Install biogas plant and phytoremediation in series to recycle water and reduce freshwater consumption.



  
PRINCIPAL  
Vignans Institute of Management & Technology For Women  
Kondapur (V), Ghatkesar (M), Medchal-Malkajgiri (Dt)-501301  
Telangana State



Presently, sewage water is being let out to the drain without treatment. An opportunity exists to generate biogas from the untreated sewage water and use the generated biogas to substitute LPG used (10cylinders/year) in the college.

### Biogas Production Potential of Wastewater

The sewage water is a useful waster as 1% of it in any quantity is a sludge which when subjected to anaerobic digestion will produce biogas. Wastewater is the effluent from household, commercial establishments and institutions, hospitals, industries and so on. Sewage water source contains large amount of organic material which can be efficiently recovered in as sludge which and when subjected to anaerobic digestion, the sludge produces methane gas (biogas).

Biogas is a mixture of gases containing 50-75% Methane, and 25-50% Carbon dioxide while 0-10% Nitrogen, 0-3% Hydrogen disulphide and 0-2% Hydrogen may be present as impurities which is produced by anaerobic digestion of organic material i.e. a sequential enzymatic breakdown of biodegradable organic

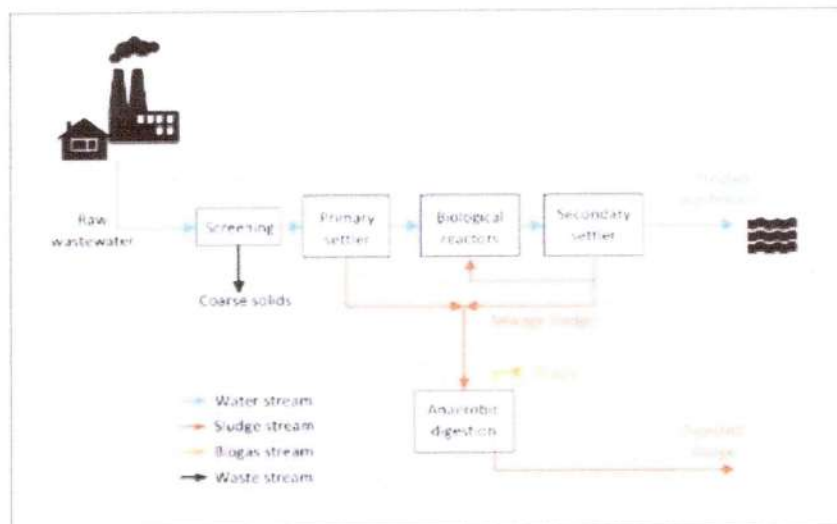

material (Biomass) in the absence of oxygen. The process is usually carried out in a digester tank known as biodigester. Biogas is an important energy source used as cooking gas, to generate electricity, etc. thus producing biogas from wastewater is an efficient and sustainable waste management and renewable energy technique. One of the major environmental problems of the world today is waste management and wastewater constitutes a huge environmental problem to the society thus the need for wastewater treatment to recover and also recycle the recovered water for usage.

**The physical process:** this is the mechanical treatment of the water that involves removal of debris from the raw wastewater right from the point it enters the plant. The screening and primary settling of debris. Wastewater enters the treatment plant through the inlet chamber from where it is channelled to the coarse screen that removes solid waste.

**The biological process:** this involve the biotreatment of the sewage in the bioreactors. It is the heart of the treatment plant where a biological process takes place. The bioreactors of a treatment plant are usually large tanks consisting of several mammoth rotors and submersible mixers. While the rotor introduces atmospheric oxygen into the sewage, the submersible mixers keep the biomass in suspension thus several reactions take place in the bioreactors.



*Principal*  
 PRINCIPAL  
 Vignan's Institute of Management & Technology For Women  
 Kondapur (V), Ghatkesar (M), Medchal-Malkajgiri (Dt)-501301  
 Telangana State

From the bioreactor, the sewage enters the sedimentation tank. Here the biological process ends and sludge is separated from water such that the clean water is passed to the disinfection tank for disinfection and onward discharge for use while the sludge is removed by the returned activation sludge (RAS) pump that removes and sends part to the anaerobic digestion chamber while some e return to the anaerobic bioreactor for reactivation.

Production of biogas is an anaerobic digestion whereby microorganisms break down biodegradable material in the absence of oxygen to produce methane/carbon dioxide used to generate electricity and heat. Sludge from the treatment plant (primary and activated sludge) is the main feedstock (biodegradable organic matter) in the biogas production plant of a wastewater treatment plant and the biogas production process involves series of steps. The combine sludge resulting from primary and secondary water treatment is gathered, sieved and thickened to a dry solids content of up to 7% before entering the digesters. Optionally, the sludge can be pre-treated by disintegration technologies with the aim to improve the gas yield. In the anaerobic digestion process, the sludge is pumped into the anaerobic continuously stirred tank reactors where digestion takes place. In the process, microorganisms break down part of the organic matter that is contained in the sludge and produce biogas, which is composed of methane, carbon dioxide and trace gases. The raw biogas produced is dried and hydrogen sulphide and other trace substances removed and burned in burners after treatment. The digested sludge is dewatered, and the water reintroduce into the treatment plant while the remaining undigested matter used for organic fertilizer.

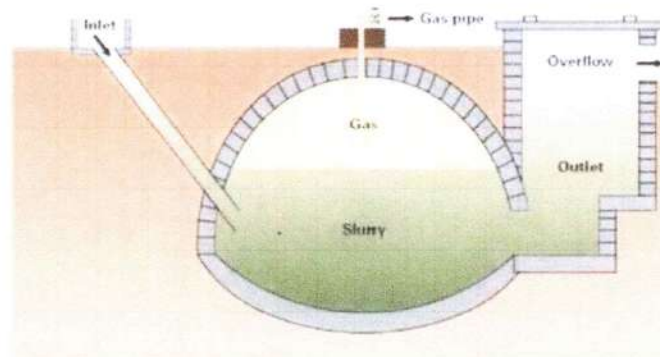

#### Rootzone treatment:

Root Zone' is a scientific term used to cover all the biological activity among different types of microbes, the roots of plants, water soil and the sun. It consists planted filter-beds containing ravel, sand and soil. The RZWT system utilises nature's way of biologically processing domestic & industrial effluents. This effective technology called Decentralised Wastewater Systems (DEWATS) was developed in 1970s in Germany and has been successfully implemented in different countries mainly in Europe and America.

The root zone wastewater treatment system makes use of biological and physical-treatment processes to remove pollutants from wastewater. Due to its natural process, there is no need to add any input such as chemicals, mechanical pumps or external energy. This reduces both the maintenance and energy costs.



*[Handwritten Signature]*  
PRINCIPAL  
Vignani's Institute of Management & Technology For Women  
Kondapur (V), Ghatkesar (M), Medchal-Malkajgiri (DT)-501301  
Telangana State

- To accomplish this, the root zone wastewater treatment undertakes the following steps:
- Pre-treatment done in a Settler - a device that separates the liquid from the solid First treatment takes place in an Anaerobic Baffled Reactor - a device with several identical chambers through which the effluent moves from top to bottom.
- Second treatment happens in an Anaerobic Filter - a device filled with a filter material (cinder), through which the effluent moves from top to bottom.

Third treatment takes place in a Planted Gravel Filter - a structure filled with gravel material and planted with water-resistant reed plants, which provide oxygen to the passing effluent.

The Root Zone Wastewater Treatment system takes into account the natural slope of the ground, so that water flows from one device to another without any ternal energy input such as motor pump. Once the reed plants create an established stand, usually after the first growing season, the reed bed requires little or no maintenance. The plant foliage will soon blend naturally into the landscape, ever changing with the seasons and creating a pleasing sight as well!



#### Install water flow meter:

Water flow meters are vital in understating the water consumption patterns of the campus. Presently, the water consumption is calculated rather than being measured. Water flow meters gives an accurate status if water consumption in the campus and from the water consumption values, the roadmap for water conservation activities can be prepared.

Water Meters would have many advantages:

- Encourage water conservation - important given strain on water resources
- Encourage allocatively efficient distribution. People would consume to where the marginal cost = marginal utility



*RAA*  
 PRINCIPAL  
 Vignani's Institute of Management & Technology  
 Kondapur (V), Ghatkesar (M), Medchal-Malkajgiri (D), 501301  
 Telangana State

- In long term lower overall water consumption would reduce leading to even lower water bills.

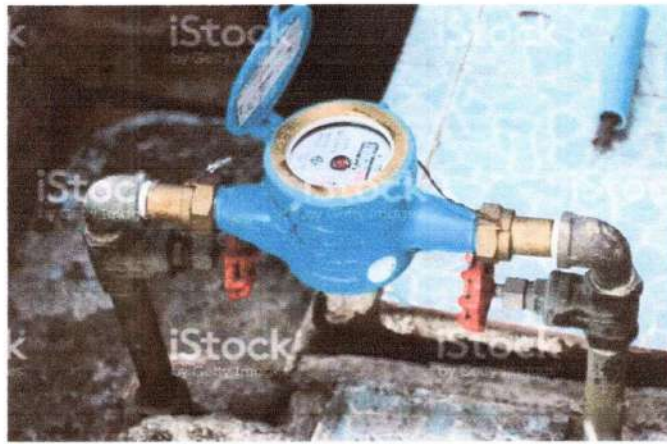

*ASh*  
PRINCIPAL

vignan's Institute of Management & Technology, For Women  
Kondapur (V), Ghatkesar (M), Medchal-Malkajgiri (Dt)-501301  
Telangana State



## Waste Management

India has drawn world's attention with its high paced urbanization and industrialization. Over the last decade, India has emerged as the fastest growing country with rapid economic growth. A renewed focus on sustainable growth and development is imperative as India strives to maintain its high GDP growth rate in its pursuit of achieving developed country status by the year 2022. However, the flip side of higher economic growth has resulted in increased consumption of the natural resources, increased waste generation and hence ecological degradation.

**Present status:** VMTW has initiated waste management activities inside its facility. Separate bins have been provided (dry and wet waste) for different types of wastes. Waste bins are provided throughout the campus and students are being urged to use the bins effectively.

**Recommendation:** The waste management yard must be maintained in a similar fashion as that of a raw material storage room. Therefore, a total revamp of the waste storage yard is to be carried out. By doing so, the quality of the materials stored in the yard will not deteriorate and can be used as a raw material for a subsequent process.

Enhance awareness creation, training and capacity building.

VMTW should focus on implementing sustainable waste management practices. VMTW should regularly interact with Pollution Control Board and TSDF operators to enhance knowledge on waste management. The team should also take efforts to communicate the waste management and other policies and activities to all students in the college.

### **Achieve zero liquid discharge status:**

VMTW may install a STP to treat and recycle water. The treated water from STP can be used to substitute freshwater by utilizing the treated water in both high end and low-end applications.



  
PRINCIPAL

Vignans Institute of Management & Technology For Women  
Kondapur (V), Ghatkesar (M), Medchal-Malkajgiri (Dt)  
Telangana State

# Conclusion

Environmental sustainability is a continuous process and there is always a scope for improvement. VMTW has displayed itself as an advocate of environmental sustainability by getting environmental audit carried out. The organization has implemented several initiatives and measures to enhance efficiency and to optimize resource intensity. The journey ahead in the path towards environmental excellence has immense scope for improvement as brought out by this report.

VMTW needs to focus and work on areas efficiency levels needs to be enhanced. For example: waste management. The observations and suggestions put forth by the report would help the facility in improving its environmental performance and pave way for ecologically sustainable growth.

This report may be taken as a guide and roadmap for achieving higher performance rating in environmental stewardship. As one of the pioneers and leaders VMTW shoulder the task of further 'learning-teaching-learning' to improve, excel, and continue the innovative efforts for success of their students and associates.



  
PRINCIPAL

Vignan's Institute of Management & Technology For Women  
Kondapur (V), Ghatkesar (M), Medchal-Malkajiri (Dt)-501301  
Telangana State

## CERTIFICATE OF COMPLETION

*This is to certify that*

*Vignan's Institute of Management and Technology for  
Women*

*has successfully completed*

ENVIRONMENTAL AUDIT

(WATER & WASTE MANAGEMENT)

The study was completed by Rekhapalli Environmental Solutions &  
Technologies Pvt Ltd



Dr Rekhapalli Srinivasa Rao

Green, Eco & Energy Lead Auditor

Certified ISO-14001 Auditor

Issued by

Rekhapalli Environmental Solutions & Technologies Pvt Ltd



December 2021



PRINCIPAL

Vignan's Institute of Management & Technology For Women  
Kondapur (V), Ghatkesar (M), Medchal-Malkajiri (Dt),  
Telangana State



VIGNAN'S INSTITUTE OF MANAGEMENT AND  
TECHNOLOGY FOR WOMEN

## Green Landscape Audit



## CONTENTS

04 Acknowledgement

05 Executive Summary

07 Introduction

13 Recommendations

14 Conclusion



  
PRINCIPAL  
Vignan's Institute of Management & Technology For Women  
Kondapur (V), Ghatkesar (M), Medchal-Malkajgiri (Dt)-501301  
Telangana State

# Acknowledgements

REST Pvt Ltd

**Dr Rekhapalli Srinivasa Rao**  
Green, Eco & Energy Lead Auditor  
Certified ISO-14001 Auditor

20 Dec 2021

## Green Landscape Audit

The REST Pvt Ltd acknowledges with thanks the cooperation extended to our team for completing the study at Vignan's Institute of Management and Technology for Women (VMTW).

The interactions and deliberations with VMTW team were exemplary and the whole exercise was thoroughly a rewarding experience for us. We deeply appreciate the interest, enthusiasm, and commitment of VMTW team towards environmental sustainability.

We are sure that the recommendations presented in this report will be implemented and the VMTW team will be further improve their environmental performance.

Kind regards

Your sincerely



**Dr Rekhapalli Srinivasa Rao**

Green, Eco & Energy Lead Auditor  
Certified ISO-14001 Auditor  
REST Pvt Ltd



  
PRINCIPAL 4 | Page  
Vignan's Institute of Management & Technology For Women  
Kondapur (V), Ghatkesar (M), Medchal-Malkajiri (Dt)-501301  
Telangana State

# Executive Summary

The growth of countries across the world is leading to increased consumption of natural resources. There is an urgent need to establish environmental sustainability in every activity we do. In a modern academy, environmental sustainability will play a critical role in the very existence of an organization.

An educational institution is no different. Built environment, especially an educational institution, has a considerable foot print on the environment. Impact on the environment due to energy consumption, water usage and waste generation in an educational institution is prominent. Therefore, there is an imminent need to reduce the overall environmental footprint of the institution.

As an institution of higher learning, Vignan's Institute of Management and Technology for Women (VMTW) firmly believes that there is an urgent need to address the environmental challenges and improve their environmental footprint.

True to its belief, VMTW maintain an excellent landscaping in its campus. The whole campus is lush green, and trees are seen everywhere around the campus. REST congratulates the VMTW for their efforts to create a truly green campus.

Based on the data submitted by VMTW team, following improvement opportunities have been identified in the campus in terms of landscaping.

- Implement ecosystem restoration by development of theme gardens in used areas of the campus
- Develop green corridors between existing areas in the campus
- Develop natural areas to encourage bird roosting and nesting in built-up areas
- Increase tree density and canopy cover in the built-up areas by planting more fruit yielding trees.
- Conduct regular flora surveys for improving the existing data
- Develop strategies for regular monitoring prevention of invasive plant species.



  
PRINCIPAL 5 | Page  
Vignan's Institute of Management & Technology For Women  
Kondapur (V), Ghatkesar (M), Medchal-Malkajgiri (Dt)-501301  
Telangana State

By addressing the improvement opportunities, the campus would be able to achieve the following benefits:

- Identifying & implementation of proper measure for conservation of endangered floral species in the campus
- Reduce the microclimate temperature of the campus by 1-2° C which is significant
- As many of the species have the capability to absorb contaminants in the air and therefore this would lead to better air quality in the campus
- This can evolve as an excellent educational campus for spreading awareness on biodiversity and benefit the nation at large.



  
PRINCIPAL  
Vignan's Institute of Management & Technology For Women  
Kondapur (V), Ghatkesar (M), Medchal-Malkajgiri (Dt)-501301  
Telangana State  
6 | Page

# Introduction

## **Urbanisation and its effect on loss of biodiversity**

Urbanization causes biodiversity to decline. As cities grow vital habitat is destroyed or fragmented into patches not big enough to support complex ecological communities. In the city, species may become endangered or even locally extinct as natural areas are swallowed up by the urban jungle.

Ironically, it is urban growth that is often responsible for the introduction of non-native species, either accidentally or deliberately, for food, pets or for aesthetic reasons.

## **Documentation of Flora**

Knowledge on biodiversity of any geographical region is a paramount importance for sustainable management and conservation plans. The foremost task in the conservation process is to prepare an inventory of species. It is necessary to have full knowledge regarding the habit, habitat, distribution and phenology of various plants for their proper conservation.

The documentation of flora will help in identifying, documenting and promoting the conservation of native flora in India. This in turn will help in promoting native species for landscapes as they suit one growing interest in "Low maintenance" gardening and landscaping.

Many species are vigorous & hard and can survive winter, cold, and summer heat. These species once established, can flourish without irrigation or fertilization and are resistant to most pests & diseases.

## **Need for documentation of Flora**

The knowledge building on significance and importance of various flora existing around us is the need of the hour. Loss of the biodiversity is likely to result in loss of various other taxonomic groups.

## **Serve as a ready reckoner:**

Most of the campuses have huge landscape with diverse floral species. Nevertheless, the availability of information on these species is minimal. Hence, the documentation of the species would serve as an educational material on the details of species existing within the campus.



  
PRINCIPAL  
Vignans Institute of Management & Technology For Women  
Kondapur (V), Ghatkesar (M), Medchal-Malkajgiri (Dt)-501301  
Telangana State

**Public Visibility:**

Despite having various biodiversity initiatives in place within the campus most of the campuses lack the visibility of the measures taken in conservation. The study will create awareness & visibility of the campus on various conservation measures implemented to the occupants as well as to the visitors.

Also, the organization will gain globally amongst its shareholders for the positive steps taken towards protecting biodiversity.

**Conservation of Species:**

Due to Urbanization most of the floral species are under tremendous pressure. The need of the hour is to conserve and protect these species. The study would help in identifying such species in the campus which need to be conserved.



  
PRINCIPAL  
Vignani's Institute of Management & Technology For Women  
Kondapur (V), Ghatkesar (M), Medchal-Malkajgiri (Dt)-Dist. Sec.  
Telangana State

# VMTW carbon sequestration through plantation

Carbon sequestration through plantation is one of the important steps towards achieving carbon neutrality. In carbon footprint calculation of VMTW, carbon sequestration through plantation is considered and due credit has been given.

No. of trees considered for carbon footprint calculation	: 128trees
CO2 absorbed by a tree in one year	: 18 kg
Total CO2 sequestered	: 128trees x 18 kg of CO2/year
	: 2304 kgs of CO2
	: 2.3 tonnes of CO2



  
PRINCIPAL  
Vignani's Institute of Management & Technology For Women  
Kondapur (V), Ghatkesar (M), Medchal-Malkajiri (Dt)-501301  
Telangana State



*Vignans*  
PRINCIPAL  
Vignans Institute of Management & Technology For Women  
Kondapur (V), Ghatkesar (M), Medchal-Malkajgiri (Dt)-501301  
Telangana State



# Plantation & Maintenance techniques

## Selection of species

- Native species like Azadirachta indica (Neem), Pongamia pinnata (Pongam tree), Cassia fistula (Indian shower tree), Butea monosperma (Flame of the forest) and also fruit bearing species like Mangifera indica (Mango), Manilkara sapota (Chikoo), Syzygium cumini (Jamun Tree), Psidium guajva (Guava), Annona squamosa (Custard apple), Punica granatum (Pomegranate), Phyllanthus emblica (Indian Gooseberry), Citrus sinensis (Sweet lime) and Citrus limon (Lime) to be selected for plantation. Neem, Mango, Palm, Areka palm, Purple heart plant, Spanish cherry, Strelitzia Nicolai and Other Trees already planted in VMTW.
- Saplings of 2-3 ft height to be considered for plantation in public areas.
- Plantation can be taken up as avenues (roadside plantation) and green belts (thick plantation in one area).
- Fruit plantation can be taken up in protected areas, institutions with large areas. Special care to be taken in maintenance since these plants also generate revenue.

## Digging of pits

Pits to be dug about one month prior to the plantation date and it should be exposed to sunlight

This will help in killing of harmful disease-causing bacteria and virus.

1. In places of no availability of proper sunlight, dry trash to be filled in the pit and burnt.
2. Pit size should be normally 2ft or 3ft and in soils which are very hard 4ft<sup>3</sup> or above to be dug.
3. Further to the digging of pit, the bottom of the pit should be loosened up to 6-9 inches.
4. While digging, we can observe different soil profiles. Topsoil will be soft and contains enough nutrients for nourishing the plant. The topsoil should be deposited on one end and hard soil on the other end. While filling the pit with soil, the topsoil only should be used. The topsoil from the non-plantation area around the pit to be collected and mixed with manure and used for filling of the pit.



  
PRINCIPAL  
Vignans Institute of Management & Technology For Women  
Kondapur (V), Ghatkesar (M), Medchal-Malkajgiri (Dt)-501301  
Telangana State

## Transportation

- Visit to the nurseries and enquire about plant species like availability, size, age and girth prior to the plantation. Also, the size of the packet in which the plant is existing to be enquired.
- Ensure that the material is available in the nursery and allotted to pick up
- The saplings to be watered one or two days prior to the movement of plants to plantation area
- The plants to be procured at least 15 days prior to plantation.
  - The saplings to be watered as soon as they reach the plantation area and regularly thereafter.
  - They should be kept in shade, non-windy & protected areas.

The above said steps to be followed for movement of plants near to the pits within the plantation area. Enough water to be stored for watering the plants after plantation. Also, tools and manpower to be kept in place to ensure proper plantation of saplings. If the sapling is bushy with many branches, then the branches are to be trimmed before plantation.

## Plantation

- The poly bag around the root ball to be carefully cut with a knife / sickle / scissors without disturbing the roots
- Rope and stakes are to be kept ready to support the plant after plantation.
- Regular watering to be done to the plants followed by mulching (loosening of top 3-4 inches of soil)
- Mulching will help in conservation of moisture, aeration of roots and control of weeds.
- Note: At least 5% of extra plants to be procured for timely gap filling and to ensure 100% survival. Care to be taken for these plants like other plants.



  
PRINCIPAL  
Vignans Institute of Management & Technology For Women  
Kondapur (V), Ghatkesar (M), Medchal-Malkajgiri (Dt)-501301  
Telangana State

# Recommendations for Enhancing Flora in Campus

## 1. Implement Ecosystem Restoration

- Develop naturalised areas in the Open Area segments
  - Wastelands in the campus can be converted to a park
- 'Theme Gardens' can be developed in unused areas of the campus to increase proportion of natural area

## 2. Enhance Ecosystem Protection

- Protect and maintain the existing Open Area segments

## 3. Planting more fruit yielding trees

- Increase tree density and canopy cover in the built-up areas

## 4. Increase number of Native Plants in the Landscape area

- Increase native plants to boost native biodiversity
  - Bees, butterflies and other insects
- Healthy native plant growth will help in easy identification of invasive alien species

## 5. Introduce more native species in Open Areas

## 6. Preventing/ Decreasing Invasive Alien Species Spread

- Identify potential threatening species in advance and implement quarantine measures
- Mass Eradication techniques for larger spreads
- Commitment to complete eradication
- Manual Uprooting of small populations

## 7. Develop natural areas to encourage bird roosting and nesting in built-up areas

## 8. Introduce features to attract birds in the built-up areas

- Bird feeders
- Water troughs/ Bird baths
- Nesting material

## 9. Improve measures for rainwater harvesting in paved and un-paved areas

- Open fields, parks, pavement landscapes, etc.
- Develop outdoor parks in open areas



  
PRINCIPAL  
Vignan's Institute of Management & Technology For Women  
Kondapur (V), Ghatkesar (M), Medchal-Malkajgiri (Dt)-501301  
Telangana State

# Conclusion

As seen in the carbon sequestration calculation, tree plantations lead to a tremendous reduction in net emissions of the campus. Therefore, VMTW needs to develop a roadmap to include tree plantation as a strategy to reduce overall carbon emissions of the campus.

Two or three small ponds may be developed in the campus for aquatic plants and water source of campus birds.

More Biodiversity conservation and preservation methods are suggested and University may apply for a branding or ranking w.r.t. its biodiversity.

Water ponds in the form of Rain water cum Roof water harvesting ponds should be developed and it will improve aquatic biodiversity also.

Heritage trees identified must be well preserved and protected taking it as a pride and privilege. It develops a strong sense of love, respect and reverence to the visitors of the campus.



  
PRINCIPAL  
Vignans Institute of Management & Technology For Women  
Kondapur (V), Ghatkesar (M), Medchal-Malkajiri (Dt)-501301  
Telangana State

## CERTIFICATE OF COMPLETION

*This is to certify that*

*Vignan's Institute of Management and Technology for  
Women*

*has successfully completed*

**GREEN LAND SCAPE AUDIT**

The study was completed by Rekhapalli Environmental Solutions &  
Technologies Pvt Ltd



**Dr Rekhapalli Srinivasa Rao**

*Green, Eco & Energy Lead Auditor  
Certified ISO-14001 Auditor*

Issued by

**Rekhapalli Environmental Solutions & Technologies Pvt Ltd**



December 2021



**PRINCIPAL**

Vignan's Institute of Management & Technology For Women  
Kondapur (V), Ghatkesar (M), Medchal-Malkajiri (Dt)-501301  
Telangana State



# VIGNAN'S INSTITUTE OF MANAGEMENT AND TECHNOLOGY FOR WOMEN

(Sponsored by Lavu Educational Society)

[Affiliated to JNTUH, Hyderabad & Approved by AICTE, New Delhi]

Kondapur (V), Ghatkesar (M), Medchal - Malkajgiri (D) - 501 301. Phone: 96529 10002/3



## INTERNAL QUALITY ASSURANCE CELL

### ACTION TAKEN REPORT OF AAA FOR 2020-21

Criteria	Observations	Action Taken
Curriculum Development/Revision Process and acceptance by Student Fraternity.	NSS Activities	As the Pandemic Hit badly there were only few NSS activities conducted in this period.
Research Promotion	Motivate faculty in bringing sponsored research Projects.	IQAC organised a Seminar on "Research and Innovation" to motivate faculty.
Research Promotion	Publications must be improved	To inculcate research culture few programs were organised by departments to encourage faculty in research publications. The following programs were organised. 1.A seminar on Research Methodology. 2.Work shop on Best Practices of High Quality Research 3.A Seminar on Identification of gap for writing a Research Proposal 4.One day seminar on Research Methodology and Tools.
Budget and Expenses	Upgradation of IT Services: 1.Bandwidth. 2.No.of Computers.	Bandwidth is upgraded from 50 Mbps to 100Mbps Procured New 132 Computers with latest configuration.
Student Centric	Improve Guest Lectures/Workshops for Students.	Conducted 13 Add on Programs. 4- Guest Lectures. 2 -soft skills Programs. 2- Life Skill Programs.
Research Promotion	MoU's to be improved	Six new MoU's /Linkages were added to the existing Collaborations with various institutions.



*[Signature]*  
PRINCIPAL  
Vignans Institute of Management & Technology For Women  
Kondapur (V), Ghatkesar (M), Medchal-Malkajgiri (Dt)-501301  
Telangana State



*[Signature]*  
IQAC CO-ORDINATOR



# VIGNAN'S INSTITUTE OF MANAGEMENT AND TECHNOLOGY FOR WOMEN

(Sponsored by Lavu Educational Society)

[Affiliated to JNTUH, Hyderabad & Approved by AICTE, New Delhi]

Kondapur (V), Ghatkesar (M), Medchal - Malkajgiri (D) - 501 301. Phone: 96529 10002/3



## INTERNAL QUALITY ASSURANCE CELL

### ACTION TAKEN REPORT OF AAA FOR 2019-20

Criteria	Observations	Action Taken
Research Promotions	Faculty Research is to be improved	IQAC organised a Seminar on Quality Research Publications.
Research Promotions	Improvement is needed in Book publications/conferences.	Motivated faculty to improve their Research approach by conducting different programs. 1.A seminar on Converting a Research Idea into Publication. 2.One week FDP on Making a Scientific Research Documents Using LATEX. 3.A Workshop on Analysis of Graphs in Research Papers. 4.Seminar on Research Publication And API. 5.Seminar On "A Step by Step Guide to Write a Good Research Paper.
Budget and Expenses	Professional Development of Faculty to be improved.	All the faculty are informed by their respective HOD's to concentrate on their Professional Development by having memberships with national and international Professional Bodies where faculty can reimburse the same with institute's research policy.
Student Centric/Teaching Learning	Modern Teaching Methods to be enhanced.	Faculty adopted modern teaching methods with the facilitated ICT Class Rooms.



*Handwritten Signature*  
PRINCIPAL

Vignan's Institute of Management & Technology For Women  
Kondapur (V), Ghatkesar (M), Medchal-Malkajgiri (Dt)-501301  
Telangana State



*Handwritten Signature*  
IQAC CO-ORDINATOR



# VIGNAN'S INSTITUTE OF MANAGEMENT AND TECHNOLOGY FOR WOMEN

Sponsored by Lavu Educational Society, Approved by AICTE, New Delhi & Affiliated to JNTUH, Hyderabad.

Kondapur (V), Ghatkesar (M), Medchal - Malkajgiri (D) - 501 301 TS INDIA

Phone: +08615 200006/07/08

Email: info@vmtw.in

## INTERNAL QUALITY ASSURANCE CELL

### **ACTION TAKEN REPORT OF AAA FOR 2018-19**

Criteria	Observations	Action Taken
Research Promotion	Research Linkages and MOU's to be improved.	5 New MOU's are signed with different institutions in this Academic Year.
Research Promotion	Research Aptitude among faculty need to be improved	IQAC Organised an Orientation programme on "Research Tools" to enhance research skills among faculty.
Research Promotion	Motivate faculty to attend more FDP's	To encourage faculty to participate in more FDP's a total of Rs.39900 has been disbursed to the faculty participated in various as per R&D Policy of the institute.
Student Centric/Teaching Learning.	ICT enabled Teaching	ICT enabled class rooms are made available.
Facilities to Students	Attention needed in Student Facilities	Identified the requirements and upgraded them by providing a new room equipped with sports facilities for multiple indoor games.
Assessment	Mid Question Papers with Bloom's Taxonomy	It is initiated and every faculty followed Bloom's Taxonomy in preparing Mid-Question Papers.



  
**PRINCIPAL**  
Vignans Institute of Management & Technology For Women  
Kondapur (V), Ghatkesar (M), Medchal-Malkajgiri (D)-501301  
Telangana State



  
**IQAC CO-ORDINATOR**





# VIGNAN'S INSTITUTE OF MANAGEMENT AND TECHNOLOGY FOR WOMEN

Sponsored by Lavu Educational Society, Approved by AICTE, New Delhi & Affiliated to JNTUH, Hyderabad.  
Kondapur (V), Ghatkesar (M), Medchal - Malkajiri (D) - 501 301 TS INDIA  
Phone: +08615 200006/07/08 Email: info@vmtw.in

## INTERNAL QUALITY ASSURANCE CELL

### ACTION TAKEN REPORT OF AAA FOR 2017-18

Criteria	Observations	Action Taken
Student and Faculty Ratio	Student and faculty ratio to be improved	Requirements from various departments is identified and initiated the process of recruitment.
Research Promotion	Quality publications must be improved	Three programs are conducted to faculty on research publications to improve Quality Publications. 1. One Day Workshop on writing a research Paper using LATEX. 2. A Two Day Workshop on Data Analysis and Interpretation. 3. One Day Workshop on Research Methodology and Data Management.
Student Centric, Teaching Learning	Orientation Programme	IQAC organised an Orientation Program on Mentor-Mentee System.
Student Centric	Life Skills development programme	Three programs on life skill development for student are conducted 1. Medical & Dental Check-up Camp 2. A seminar on "Importance of Sports/Games in Emotional Balance" 3. International Yoga Day.



  
PRINCIPAL  
Vignan's Institute of Management & Technology For Women  
Kondapur (V), Ghatkesar (M), Medchal-Malkajiri (D)-501301  
Telangana State



  
IQAC CO-ORDINATOR

Collaborative quality  
initiatives with other  
institutions



# VIGNAN'S INSTITUTE OF MANAGEMENT AND TECHNOLOGY FOR WOMEN

Sponsored by Lavu Educational Society, Approved by AICTE, New Delhi & Affiliated to JNTUH, Hyderabad.  
Kondapur (V), Ghatkesar (M), Medchal - Malkajgiri (D) - 501 301 Phone: +91 96529 10002/3



## List of activities conducted under each MoU along with Dates of starting and completion year wise signed by both parties

S.No	Name of the collaborating agency MoU/linkage	Date of signing/renewal MoU/collaboration	Duration	Activities under each MoU	Page No
1	EducateNXT	22.04.2022	1 Year	Workshop	3 - 10
2	Samskruti Foundation	30.12.2021	1 Year	Career in yoga	11-14
3	EdifyPath educational Services Pvt.Ltd	08.12.2021	1 Year	Industrial Visit	15-24
4	Huawei Services (hongkong)Co.Limited	01.12.2021	3 Years	Workshop	25-32
5	Edugene Technologies Private Limited	29.09.2021	1 Year	Workshop	33-38
6	Cyient Ltd	20.09.2021	1 Year	Workshop	39-44
7	Stem World	17.09.2021	1 Year	Internship	45-50
8	Deccan solutions	10.09.2021	1 Year	Internship	51-55
9	MCEE Solutions Private Limited	09.09.2021	1 Year	Internship	56-60
10	Internshala, Scholiverse Educare Pvt. Ltd	26.08.2021	1 Year	Short Term Training	61-63
11	Ambest Technovation Private Limited	12.08.2021	1 Year	Workshop	64-72
12	Path Creators, Sri Vaikunta Technologies Pvt. Ltd	20.07.2021	1 Year	Internship	73-79
13	Coign Consultants Pvt.Ltd.	07.06.2021	2 Years	Short Term Training	80-85
14	Six Phrase The Finishing School	17.02.2021	1 Year	Short Term Training	86-90
15	Kodnest Technologies	05-02-2021	1 Year	Seminar	91-95
16	ACE Engineering College	15-09-2020	5 Years	Seminar	96-101
17	Edunet Foundation	06-08-2020	1 Year	Workshop	102-110
18	ADITI Software	30-07-2020	1 Year	Workshop	111-116
19	Truechip Solutions Pvt.Ltd	26-06-2020	2 Years	Workshop Addon Course	117-220
20	CAI	10-01-2020	2 Years	Industrial Visit	221-231



PRINCIPAL  
Vignans Institute of Management & Technology For Women  
Kondapur (V), Ghatkesar (M), Medchal-Malkajgiri (D)-501301  
Telangana State



# VIGNAN'S INSTITUTE OF MANAGEMENT AND TECHNOLOGY FOR WOMEN

Sponsored by Lavu Educational Society, Approved by AICTE, New Delhi & Affiliated to JNTUH, Hyderabad.  
Kondapur (V), Ghatkesar (M), Medchal - Malkajgiri (D) - 501 301 Phone: +91 96529 10002/3



21	J.B. Institute of Engineering & Technology	03-10-2019	5 Years	Workshop	232-238
22	Indian Placement Service Center	23-08-2019	1 Year	Short Term Training	239-242
23	Fourth ambit Employability Services	21-08-2019	1 Year	Short Term Courses	243-247
24	Techona Enterprises	09-08-2019	2 Years	Workshop	248-254
25	Samskruti College of Engineering & Technology	07-08-2019	5 Years	Workshop	255-262
26	Tech Fort Solutions Services Pvt Ltd	08-07-2019	1 Year	Workshop	263-271
27	Deeksha Technologies	01-07-2019	2 Years	Workshop	272-295
28	Joginpally B.R. Engineering College	12-06-2019	5 Years	Seminar	296-301
29	Sri Gajanan E-Slates Pvt.Ltd	26-12-2018	1 Year	Industrial Visit	302-312
30	CoCubes Technologies Pvt.Ltd.	26-12-2018	1 Year	Short Term Courses	313-317
31	Tagit Consulting	03-10-2018	1 Year	Seminar	318-323
32	Brain o vision solutions Pvt.Ltd	05-09-2018	5 Years	Internship. Workshop	324-330
33	FACE An IIM Graduates Enterprise	24-08-2018	2 Years	Training on Technical and Non-technical courses	331-335
34	Elegant Embedded Systems Pvt.Ltd	17-07-2017	4 Years	Industrial Visit Workshop. Seminar. Addon Course	336-535
35	CodeMax IT Solutions Pvt. Ltd	10-07-2017	1 Year	Short Term Courses	536-539
36	Telangana academy for skill and Knowledge(TASK)	28-06-2017	3 Years	Short Term Courses	540-544
37	Bheri Overseas Education services	20-06-2017	2 Years	Short Term Courses	545-548
38	Armtronics	15-06-2017	2 Years	Addon Course	549-616
39	Valmiki Foreign Education Services	06-04-2017	2 Years	Career Guidance & Awareness Programs	617-621



PRINCIPAL

Vignans Institute of Management & Technology For Women  
Kondapur (V), Ghatkesar (M), Medchal-Malkajgiri (Dt)-501301  
Telangana State



# VIGNAN'S INSTITUTE OF MANAGEMENT AND TECHNOLOGY FOR WOMEN

Sponsored by Law Educational Society, Approved by AICTE, New Delhi & Affiliated to JNTUH, Hyderabad.  
Kondapur (V), Ghatkesar (M), Medchal - Malkajgiri (D) - 501 301 Phone: +91 96529 10002/3



VMTW/CSE/CIR/2021-22/II/05

Date: 16/05/2022

## CIRCULAR

This is to inform all the faculties and students that there is a Three-Day Workshop on "Amazon web services in Cloud Environment" scheduled on 18-05-2022 to 20-05-2022. In this regard students are instructed to attend the workshop without fail

  
**PRINCIPAL**

Vignans Institute of Management & Technology For Women  
Kondapur (V), Ghatkesar (M), Medchal-Malkajgiri (D)-501301  
Telangana State

### Copy to:

1. CEO for information,
2. All the Deans,
3. The HOD (CSE / ECE / EEE / IT / AIML / BSH),
4. IQAC,
5. Admin Office,
6. All Notice Boards,
7. Circulate to all Class Rooms,
8. File.



  
**PRINCIPAL**  
Vignans Institute of Management & Technology For Women  
Kondapur (V), Ghatkesar (M), Medchal-Malkajgiri (D)-501301  
Telangana State



## VIGNAN'S INSTITUTE OF MANAGEMENT AND TECHNOLOGY FOR WOMEN

(Sponsored by Lavu Educational Society)

Approved by AICTE, New Delhi & Affiliated to JNTUH, Hyderabad.

Kondapur (V), Ghatkesar (M), Medchal - Malkajgiri (D) - 501 301



### DEPARTMENT OF COMPUTER SCIENCE AND ENGINEERING

# A THREE-DAY WORKSHOP ON AMAZON WEB SERVICES IN CLOUD ENVIRONMENT

## 18<sup>TH</sup> - 20<sup>TH</sup> MAY, 2022 @ SEMINAR HALL



In association with  
**EducateNXT**

Resource Person:  
**Mr. Gopinath Purushetty**  
Head-Institutional Alliances,  
EducateNXT

Chief Patron:  
**Dr. Lavu Rathaiah**,  
Chairman, Vignan Group.

Patron:  
**Mr. B. Shivan**,  
CEO, Vignan Group.

Co-Patron:  
**Dr. G. Apparao Naidu**,  
Principal, VMTW.

Advisor:  
**Dr. A. Sudhir Babu**,  
Associate Professor & HOD,  
Dept. of CSE.

Co-Ordinator:  
**Mrs. K. Prathyusha**,  
Assistant Professor,  
Dept. of CSE.  
Cell: +91 79958 06494



*WASH*  
**PRINCIPAL**  
Vignan's Institute of Management & Technology For W.  
Kondapur(V), Ghatkesar(M), Medchal-Malkajgiri(DT)-501301  
Telangana State



# VIGNAN'S INSTITUTE OF MANAGEMENT AND TECHNOLOGY FOR WOMEN

Sponsored by Laxmi Educational Society, Approved by AICTE, New Delhi & Affiliated to JNTUH, Hyderabad.  
Kondapur (V), Ghatkesar (M), Medchal - Malkajgiri (D) - 501 301 Phone: +91 96528 10002/3



## DEPARTMENT OF COMPUTER SCIENCE AND ENGINEERING

Date: 23-05-2022

### Report on "Amazon Web services in Cloud Environment"

**Type of Program:** Workshop

**Date:** 18-05-2022 to 20-05-2022

**No. of Students Participated:** 117

**Faculty Coordinator:** Mrs.P.Prathyusha

**Resource Person:** Mr.GopinathPuralachetty

Head-Institutional Alliance Educate NXT

**Objective:** Expand the knowledge about Cloud computing, understand the Architecture of Cloud computing, hands on practice on Amazon Web Services and Cloud computing.

**Outcomes:** Students were aware about Cloud Computing, Students get knowledge about Cloud Infrastructure and its Services, Students get idea about how Cloud computing works, Students were aware with AWS services, Students get knowledge how to configure two servers, Students were aware how AWS works.



AWS is designed to allow application providers, ISVs, and vendors to quickly and securely host your applications – whether an existing application or a new SaaS-based application.

  
COORDINATOR

  
H.O. D  
Head of The Department  
Computer Science and Engineering  
Vignans Institute of Management & Technology For Women  
Kondapur (V), Ghatkesar (M), Medchal-Malkajgiri (Dt)-501301  
Telangana State



  
PRINCIPAL  
Vignans Institute of Management & Technology For Women  
Kondapur(V),Ghatkesar(M),Medchal-Malkajgiri(Dt)-501301  
Telangana State

**Workshop on Amazon Web Services in Cloud Environment**

**Course Instructor: Gopinath Puralachetty**

S.No	Roll No	Name	18/05	19/05	20/05
1	186P1A0539	R Sri Vaishnavi	Vaishnavi	Vaishnavi	Vaishnavi
2	18C21A0501	Aavula Swetha	Swetha	Swetha	Swetha
3	18C21A0520	Konda Raga Sudha	Ragasudha	Ragasudha	Ragasudha
4	18C21A0522	Kurakula Srilekha	Srilekha	Srilekha	Srilekha
5	18C21A0561	Putta Prathyusha	Prathyusha	Prathyusha	Prathyusha
6	18UP1A0501	Anreddy Pooja Sree	Pooja Sree	Pooja Sree	Pooja Sree
7	18UP1A0502	Are Sadhana	Sadhana	Sadhana	Sadhana
8	18UP1A0503	Avula Kavya Sri	Kavya Sri	Kavya Sri	Kavya Sri
9	18UP1A0504	Balne Unvitha	Unvitha	Unvitha	Unvitha
10	18UP1A0505	Bandaru Pranathi	Pranathi	Pranathi	Pranathi
11	18UP1A0506	Bellamkonda Vyshnavi	Vyshnavi	Vyshnavi	Vyshnavi
12	18UP1A0507	Challa Mahima Chandra	Chandra	Chandra	Chandra
13	18UP1A0508	Dasari Ruchitha	Ruchitha	Ruchitha	Ruchitha
14	18UP1A0509	Deekonda Raaga Priya	Priya	Priya	Priya
15	18UP1A0510	Devandla Swapna	Swapna	Swapna	Swapna
16	18UP1A0511	Devisetti Ashritha	Ashritha	Ashritha	Ashritha
17	18UP1A0512	Eliti Nandini	Nandini	Nandini	Nandini
18	18UP1A0513	Gujja Harshitha Reddy	Harshitha	Harshitha	Harshitha
19	18UP1A0514	Gajula Vidya	Vidya	Vidya	Vidya
20	18UP1A0515	Guntur Komali	Komali	Komali	Komali
21	18UP1A0516	Jeeyar Prasanna	Prasanna	Prasanna	Prasanna
22	18UP1A0517	K Rishika	Rishika	Rishika	Rishika
23	18UP1A0519	Kandakatla Navya	Navya	Navya	Navya
24	18UP1A0520	Kappari Sowmya	Sowmya	Sowmya	Sowmya
25	18UP1A0521	Karla Keerthana	Keerthana	Keerthana	Keerthana
26	18UP1A0522	Koppu Alekhya	Alekhya	Alekhya	Alekhya
27	18UP1A0523	Kotha Sravani	Sravani	Sravani	Sravani
28	18UP1A0524	M.Sravani	Sravani	Sravani	Sravani
29	18UP1A0525	Miriyala Reshika	Reshika	Reshika	Reshika
30	18UP1A0526	Molugu Manasa	Manasa	Manasa	Manasa
31	18UP1A0527	Mukka Mahima	Mahima	Mahima	Mahima
32	18UP1A0528	Mullapudi Yoshnavi Naga Lakshmi	Lakshmi	Lakshmi	Lakshmi
33	18UP1A0529	Muppalla Sai Sree	Sai Sree	Sai Sree	Sai Sree
34	18UP1A0530	Nangunuri Akhila	Akhila	Akhila	Akhila
35	18UP1A0531	Nandamuri Sneha	Sneha	Sneha	Sneha



PRINCIPAL

Vignans Institute of Management & Technology For Women,  
Kondapur(V), Ghatkesar(M), Medchal-Malkajgiri(Dt)-501301  
Telangana State



36	18UP1A0532	Neeluri Rishita	Rishita	Rishita	Rishita
37	18UP1A0533	Palvai Nikhitha	Nikhitha	Nikhitha	Nikhitha
38	18UP1A0534	Panjala Chandana	Chandana	Chandana	Chandana
39	18UP1A0536	Pasham Shravani	Shravani	Shravani	Shravani
40	18UP1A0537	Pasunuti Sindhu	Sindhu	Sindhu	Sindhu
41	18UP1A0538	Neeharika Patel	Neeharika	Neeharika	Neeharika
42	18UP1A0539	Pothureddypalli Ikyatha	Ikyatha	Ikyatha	Ikyatha
43	18UP1A0540	Raju Bindu	Bindu	Bindu	Bindu
44	18UP1A0541	Raparathi Sathvika	Sathvika	Sathvika	Sathvika
45	18UP1A0543	S Meghana	Meghna	Meghna	Meghna
46	18UP1A0544	Sai Mounika Viyyapu	Saimounika	Saimounika	Saimounika
47	18UP1A0545	Sanka Ramasai	Ramasai	Ramasai	Ramasai
48	18UP1A0546	Singaram Priyanshi	Priyanshi	Priyanshi	Priyanshi
49	18UP1A0547	Suryadevara Maneesha	Maneesha	Maneesha	Maneesha
50	18UP1A0548	Telukutla Priyanka	Priyanka	Priyanka	Priyanka
51	18UP1A0549	Talapalli Sahithi	Sahithi	Sahithi	Sahithi
52	18UP1A0550	Nikhitha Thumula	Thumula	Thumula	Thumula
53	18UP1A0551	Venakadasula Sravanapragathi	Sravana	Sravana	Sravana
54	18UP1A0552	V Shravya	Shravya	Shravya	Shravya
55	18UP1A0553	Vemula Sai Esha	Sai Esha	Sai Esha	Sai Esha
56	18UP1A0554	Volloju Jagadeshwari	Jadesh	Jadesh	Jadesh
57	18UP1A0555	Vunnam Sushmithasiri	Sushmitha	Sushmitha	Sushmitha
58	18UP1A0556	Voruganti Rochishna	Rochishna	Rochishna	Rochishna
59	18UP1A0557	Manepalli Eswari Sai Sarayu	Sarasu	Sarasu	Sarasu
60	18UP1A0558	Indela Dharani	Dharani	Dharani	Dharani
61	18UP1A0559	Achalla Yagnamukhi	Yagnam	Yagnam	Yagnam
62	18UP1A0560	Alapati Harshini	Harshini	Harshini	Harshini
63	18UP1A0561	Ankam Jaswitha	Jaswitha	Jaswitha	Jaswitha
64	18UP1A0562	Arvapalli Bhagya Chandana	Chandana	Chandana	Chandana
65	18UP1A0563	Bathina Harshitha	Harshitha	Harshitha	Harshitha
66	18UP1A0564	Bheemaraju Lakshmi Manasa	Manasa	Manasa	Manasa
67	18UP1A0565	Bojja Priyanka	Priyanka	Priyanka	Priyanka
68	18UP1A0566	Bramanapally Supriya	Supriya	Supriya	Supriya
69	18UP1A0567	Cheeli Swetha	Swetha	Swetha	Swetha
70	18UP1A0568	Chilam Anuradha	Anuradha	Anuradha	Anuradha
71	18UP1A0569	Chirala Ramya	Ramya	Ramya	Ramya
72	18UP1A0570	Damsani Srija	Srija	Srija	Srija
73	18UP1A0571	Gunda Abhi Sri	Abhisri	Abhisri	Abhisri
74	18UP1A0572	Gandhamalla Hema Latha	Hemalatha	Hemalatha	Hemalatha



*Vignana*

**PRINCIPAL**  
Vignana's Institute of Management & Technology For Women  
Kondapur(V), Ghatkesar(M), Medchal-Malkajgiri(Dr)-501301  
Telangana State

75	18UP1A0573	Gollapudi Likhita	Likhita	Likhita	Likhita
76	18UP1A0574	Gutta Lathika Chowdary	Lathika	Lathika	Lathika
77	18UP1A0575	J Lalitha Priya	Priya	Priya	Priya
78	18UP1A0576	Jillala Mysasree	Mysasree	Mysasree	Mysasree
79	18UP1A0577	Kallutla Jaya Sindhuri	Jaya	Jaya	Jaya
80	18UP1A0578	Korrapati Mrudhula	Mrudhula	Mrudhula	Mrudhula
81	18UP1A0579	Kota Vasavi Vineetha	Vineetha	Vineetha	Vineetha
82	18UP1A0580	Kotha Srinidhi	Srinidhi	Srinidhi	Srinidhi
83	18UP1A0581	Manepalli Pooja Sai Sree	Sree	Sree	Sree
84	18UP1A0582	Machan Anuksha	Anuksha	Anuksha	Anuksha
85	18UP1A0583	Madishetty Manasa	Manasa	Manasa	Manasa
86	18UP1A0584	Matroju Shravya	Shravya	Shravya	Shravya
87	18UP1A0585	Medhireddy Sharanya Reddy	Sharanya	Sharanya	Sharanya
88	18UP1A0586	Methukula Harshitha Mahesh	Mahesh	Mahesh	Mahesh
89	18UP1A0587	Miryala Pooja	Pooja	Pooja	Pooja
90	18UP1A0588	N Naga Deepthi	Deepthi	Deepthi	Deepthi
91	18UP1A0589	Narikonda Bhanusree	Bhanusree	Bhanusree	Bhanusree
92	18UP1A0590	Neela Akhila	Akhila	Akhila	Akhila
93	18UP1A0591	Neelapala Monika	Monika	Monika	Monika
94	18UP1A0592	Neeradi Pravalika	Pravalika	Pravalika	Pravalika
95	18UP1A0593	P Hemalatha	Hemalatha	Hemalatha	Hemalatha
96	18UP1A0595	Raavi Harshitha	Harshitha	Harshitha	Harshitha
97	18UP1A0596	Rakkireddy Vinitha	Vinitha	Vinitha	Vinitha
98	18UP1A0597	Rangu Sushma	Sushma	Sushma	Sushma
99	18UP1A0598	Renikindi Ridhima	Ridhima	Ridhima	Ridhima
100	18UP1A0599	Sainikhitha	Sainikhitha	Sainikhitha	Sainikhitha
101	18UP1A05A0	Sakkirolla Sriraaga	Sriraaga	Sriraaga	Sriraaga
102	18UP1A05A1	Samala Akshitha	Akshitha	Akshitha	Akshitha
103	18UP1A05A2	Sangeetha	Sangeetha	Sangeetha	Sangeetha
104	18UP1A05A3	Savalam Bhavani	Bhavani	Bhavani	Bhavani
105	18UP1A05A4	Shaista Sameen	Sameen	Sameen	Sameen
106	18UP1A05A5	Silveri Rasagnya	Rasagnya	Rasagnya	Rasagnya
107	18UP1A05A6	Somarouthu Sai Niharika	Niharika	Niharika	Niharika
108	18UP1A05A7	Sri Vani Madhav	Vani	Vani	Vani
109	18UP1A05A8	Tadisetti Sravya	Sravya	Sravya	Sravya
110	18UP1A05A9	Thandar Palli Swathi	Swathi	Swathi	Swathi
111	18UP1A05B0	Uppuluri Bharathi	Bharathi	Bharathi	Bharathi
112	18UP1A05B1	Vandana Pavani	Pavani	Pavani	Pavani
113	18UP1A05B2	Vinjaneni Navya	Navya	Navya	Navya



*[Signature]*  
PRINCIPAL

Yagna Institute of Management & Technology For Women  
Vondapur(V), Ghatkesar(M), Medchal-Malkajgiri(Dt)-501301  
Telangana State

114	18UP1A05B3	Yamajala Sai Venkata Naga Sriya	Sriya	Sriya	Sriya
115	18UP1A05B4	Yerukala Nuthana	Nuthana	Nuthana	Nuthana
116	19UP5A0501	Palle Kavya	Kavya	Kavya	Kavya
117	19UP5A0502	Sevella Sravanthi	Sravanthi	Sravanthi	Sravanthi

*Bathur*

**COORDINATOR**

*AS*

**H.O. D**

Head of The Department  
Computer Science and Engineering  
Vignn's Institute of Management & Technology For Women  
Kondapur (V), Ghatkesar (M), Medchal-Malkajiri (Dt)-501301  
Telangana State



*ASH*

**PRINCIPAL**

Vignn's Institute of Management & Technology For Women  
Kondapur(V), Ghatkesar(M), Medchal-Malkajiri(Dt)-501301  
Telangana State



# VIGNAN'S INSTITUTE OF MANAGEMENT AND TECHNOLOGY FOR WOMEN

(Sponsored by Lavu Educational Society)

Approved by AICTE, New Delhi & Affiliated to JNTUH, Hyderabad.

Kondapur (V), Ghatkesar (M), Medchal - Malkajgiri (D) - 501 301

Accredited By



In association with:

## EducateNXT

## Certificate of Participation

*This certificate is presented to Ms. .... **B. Priyanka** .....  
for her participation in a three-day workshop on "Amazon Web Services in Cloud Environment" held from 18-05-2022 to 20-05-2022, Organized by the Department of Computer Science and Engineering, in association with EducateNXT, Hyderabad.*



*ASH*  
PRINCIPAL  
Vignans Institute of Management & Technology For Women  
Kondapur (V), Ghatkesar (M), Medchal-Malkajgiri (DL)-501301  
Telangana State

*Pallusha*  
Co-Ordinator

*AS*  
HoD, CSE

*ASH*  
Principal



# VIGNAN'S INSTITUTE OF MANAGEMENT AND TECHNOLOGY FOR WOMEN

Sponsored by Lavu Educational Society, Approved by AICTE, New Delhi & Affiliated to JNTUH, Hyderabad.  
Kondapur (V), Ghatkesar (M), Medchal - Malkajgiri (D) - 501 301 Phone: +91 96529 10002/3.



VMTW/CSE/CIR/2021-22/II/09

Date: 21-03-2022

## CIRCULAR

All the HODs are here by requested to inform 1<sup>st</sup>B.Tech students that "**Career in Yoga**" will be conducted in our college on 25-03-2022 for all students.

Contact Concerned HOD for further information.

Copy to:

1. CEO for information,
2. All the Deans,
3. The HOD (CSE / ECE / EEE / IT / AIML / BSH),
4. IQAC,
5. Admin Office,
6. All Notice Boards,
7. Circulate to all Class Rooms,
8. File.

PRINCIPAL  
PRINCIPAL

Vignan's Institute of Management & Technology For Women  
Kondapur (V), Ghatkesar (M), Medchal-Malkajgiri (Dt)-501301  
Telangana State



PRINCIPAL  
Vignan's Institute of Management & Technology For Women  
Kondapur (V), Ghatkesar (M), Medchal-Malkajgiri (Dt)-501301  
Telangana State



# VIGNAN'S INSTITUTE OF MANAGEMENT AND TECHNOLOGY FOR WOMEN

Sponsored by Lavu Educational Society, Approved by AICTE, New Delhi & Affiliated to JNTUH, Hyderabad.  
Kondapur (V), Ghatkesar (M), Medchal - Malkajgiri (D) - 501 301 Phone: +91 96529 10002/3



Date: 28-03-2022

## Report on Career in Yoga Program Conducted by Samskruti Foundation

**Name of the Program:** Career in Yoga

**Name of the instructor:** N. Sathyavathi

**Name of the Organization:** Samskruti Foundation.

**Dates of the program:** 25-03-2022.

**Number of students attended:** 63

**Objective:** Promoting Well-being, Inspiring Others, Creating a Safe and Supportive Environment, Personal Growth and Development.



**Outcome:** Personal Growth and Transformation, Physical Health and Well-being improved Positive Impact on Others, Community Connection and Support, Professional Growth.

The undersigned thanked the respective department coordinators and Samskruti Foundation, for their able support in completing the program successfully.



  
**PRINCIPAL**  
Vignan's Institute of Management & Technology For Women  
Kondapur(V), Ghatkesar(M), Medchal-Malkajgiri(D)-501301  
Telangana State

Name of the Organization: Samskruti Foundation

Course instructor: N. Sathyavathi

**Program Conducted by Samskruti Foundation**

**CSE Students**

S.No	Hall Ticket No	Name of the Candidate	Signature
1	21UP1A05D1	A Shruthika	
2	21UP1A05D2	Ande Harshini	
3	21UP1A05D3	Anugu Harshitha	
4	21UP1A05D4	Are Chaya Siri	
5	21UP1A05D5	B Sri Saugandhika	
6	21UP1A05D6	Bandari Bhavani	
7	21UP1A05D7	Boda Sri Varshini Yadav	
8	21UP1A05D8	Bollu Manasa	
9	21UP1A05D9	Bomma Swetha Priya	
10	21UP1A05E0	Bommakanti Bilwani	
11	21UP1A05E1	Bommara Ravali	
12	21UP1A05E2	Boreddy Supriya Reddy	
13	21UP1A05E3	Budarapu Aishwarya	
14	21UP1A05E4	Challa Sneha	
15	21UP1A05E5	Daggula Shreetha	
16	21UP1A05E6	Dandem Pavani	
17	21UP1A05E7	Dasari Sri Ragni	
18	21UP1A05E8	Deshamoni Pranitha	
19	21UP1A05E9	Dornala Sravani	
20	21UP1A05F0	Gajjela Swarani	
21	21UP1A05F1	Ganji Varsha	
22	21UP1A05F2	Gattu Keerthi	
23	21UP1A05F3	Gottimukkula Ruchitha	
24	21UP1A05F4	Jella Vaidehi	
25	21UP1A05F5	Jogi Gouthami	
26	21UP1A05F6	K Pallavi Sen	
27	21UP1A05F7	Kankanala Rohini	
28	21UP1A05F8	Kola Nirmala	
29	21UP1A05F9	Korukoppula Reethika	
30	21UP1A05G0	Madas Tejasri	
31	21UP1A05G1	Maddela Manisha	
32	21UP1A05G2	Mandem Sree Durga	



PRINCIPAL

Samskruti Institute of Management & Technology For Women  
Kondapur(V), Ghatkesar(M), Medchal-Malkajgiri(Dt)-501301  
Telangana State

33	21UP1A05G3	Manneru Sriharsha	Sriharsha
34	21UP1A05G4	Mansarani Ravi Bahuriya	Bahuriya
35	21UP1A05G5	Naguri Akshitha	Akshitha
36	21UP1A05G6	Nimmanagattu Neha	Neha
37	21UP1A05G7	P. Nikitha	Nikitha
38	21UP1A05G8	Pamarthi Bhagya Sri	Bhagya Sri
39	21UP1A05G9	Pandiri Bhumika	Bhumika
40	21UP1A05H0	Panganamamula Usha Sarvani	Usharani
41	21UP1A05H1	Pati Yogitha	Yogitha
42	21UP1A05H2	Peddi Nandini	Nandini
43	21UP1A05H3	Pidugu Varshika	Varshika
44	21UP1A05H4	Ponnada Hemanjali	Hemanjali
45	21UP1A05H5	Rati Harshitha	Harshitha
46	21UP1A05H6	Shravani Thakur	Thakur
47	21UP1A05H7	Singaram Nandini	Nandini
48	21UP1A05H8	Singireddy Poojitha	Poojitha
49	21UP1A05H9	Singireddy Udaya Sri	Udaya Sri
50	21UP1A05I0	Sk Fouziya	Fouziya
51	21UP1A05I1	Soppari Nithyasri	Nithyasri
52	21UP1A05I2	T Pragathi	Pragathi
53	21UP1A05I3	Tallapalli Greeshma	Greeshma
54	21UP1A05I4	Tanniru Mamatha	Mamatha
55	21UP1A05I5	Thadakamalla Nirmala	Nirmala
56	21UP1A05I6	Udayabhanu Srinivas Rao Vunnava	Vunnava
57	21UP1A05I7	Uppaluri Hasya Charvy	Hasya Charvy
58	21UP1A05I8	Uppugalla Srivani	Srivani
59	21UP1A05I9	Vajja Navya Reddy	Navya Reddy
60	21UP1A05J0	Valdasu Chandana	Chandana
61	21UP1A05J1	Y Deepika Reddy	Deepika Reddy
62	21UP1A05J2	Yarramada Shirisha	Shirisha
63	21UP1A05J3	Yellapragada Naga Kasi Annapurna	Annapurna



*[Handwritten Signature]*

PRINCIPAL

Vignana's Institute of Management & Technology For Women  
Kondapur(V), Ghatkesar(M), Medchal-Malkajgiri(Dt)-501301  
Telangana State





# Industrial Visit Collaborated with Edify path



  
PRINCIPAL  
Vignans Institute of Management & Technology For Women  
Kondapur (V), Ghatkesar (M), Medchal-Malkajgiri (D),-501301  
Telangana State



# VIGNAN'S INSTITUTE OF MANAGEMENT AND TECHNOLOGY FOR WOMEN

(Sponsored by Lavu Educational Society)

[Affiliated to JNTUH, Hyderabad & Approved by AICTE, New Delhi]



27-02-2022

Shri A Rajarajan,  
Director of Satish Dawan Space Center (SDSC).  
SHAR, Sriharikota, Nellore Dist-524124

**Sub: Permission for Industrial visit—Reg.**

Dear Sir,

We are one of the 8 well reputed engineering Institutions under Vignans's Group of Institutions, situated in Kondapur about 15kms from city of Hyderabad. We are always ranked within first 10 ranks in JNTUH. We have B.Tech. Courses in many branches of engineering, including ECE and CSE. We would like our students to get exposed to industrial environment and more importantly industry practices, which would help them, upon their entry into any industry, to get set faster for the industry environment and deliver their jobs efficiently.

We wish to organize an industrial visit to SHAR, during the 2<sup>nd</sup> week of March, 2022. We understand that SHAR is on the forefront to nurture the students of nation and would play a vital role in contributing their knowledge. We wish to get an opportunity for our women engineers to visit your organization and understand real-time entrepreneurial activities. We wish to arrange this visit for III B. Tech. Students on 8<sup>th</sup> & 9<sup>th</sup> of March, 2022. Request you to let us know the feasibility of the dates mentioned. Kindly accord permission for 152 students for a visit to your campus.

Thanking you.

Yours sincerely



  
PRINCIPAL  
Vignans Institute of Management & Technology For Women  
Kondapur (V), Ghatkesar (M), Medchal-Malkajgiri (Dt) - 501301  
Telangana State

  
PRINCIPAL  
Vignans Institute of Management & Technology For Women  
Kondapur(V), Ghatkesar(M), Medchal-Malkajgiri(Dt)-501301  
Telangana State



# VIGNAN'S INSTITUTE OF MANAGEMENT AND TECHNOLOGY FOR WOMEN

(Sponsored by Lavu Educational Society)

[Affiliated to JNTUH, Hyderabad & Approved by AICTE, New Delhi]

Kondapur (V), Ghatkesar (M), Medchal - Malkajgiri (D) - 501 301. Phone: 96529 10002/3



## Department of Computer Science and Technology

11-03-2022

### NOTE

Sub: Report of Industrial Visit to "Satish Dawan Space Center" conducted on 09 March, 22- reg.

#### **EVENT DESCRIPTION:**

An Industrial visit has been organized by Department of Computer Science Engineering for III year Students on 09<sup>th</sup> March, 2022. The Main objective of the visit was to provide a technical Exposure to the students about Space Technology.

Totally 150 students of III year CSE of Vignans Institute of Management and Technology for Women) Visited ISRO, SATHISH DHAWAN space center.

#### **SESSION ACTIVITIES:**

The students were accompanied by 4 faculty members. The buses with students have started from our college city office at 10:00 pm on 10/03/2022 and reached the ISRO campus at 10:30 am.

ISRO VISIT: Students visited ISRO and learnt about

- LCC (launching control centre)
- MCC (machine control centre)
- SLP(second launch pad )
- FLP(first launch pad )
- ISTRAC(ISRO telemetry tracking and network centre)

Forenoon session, we visited the space museum in the same campus the visit came to an end at 4:30 pm. It was informative, interesting and successful visit.

SATISH DHAWAN SPACE CENTRE (SDSC) or SRIHARI KOTA HIGH ALTITUDE RANGE (SHAR) is a rocket launch centre operated by Indian space research organization (ISRO). It is located in Sriharikota in Andhrapradesh. The Sriharikota range has been chosen for its proximity to the equator and to use the rotation of the earth. It is close to lake PULIKAT and it is about 100km north of Chennai and close to the BAY OF BENGAL.

We learnt about the computer system used in LCC for launch control. In MCC(machine control centre) is the focal point controlling vehicle. There are 8 hold buttons at different places around the range in case of abnormalities in sub-systems, the hold button is used to terminate the count down. In case the abnormality has been resolved the first row is used to supervise to control



*[Signature]*

PRINCIPAL

Vignans Institute of Management & Technology For Women  
Kondapur(V), Ghatkesar(M), Medchal-Malkajgiri(D)-501301  
Telangana State



the operations on the vehicle various chiefs of operations are seated in these rows is computers are connected by Ethernet and fiber optics.

FIRST LAUNCH PAD (FLP) is the polar

satellite launch vehicle (PSLV). it is one of the 2 orbit launch pads at the site the other been the second launch pad. Unlike the UMBILICAL type this is a PEDESTAL type the whole tower moves away from the rocket just before the blast off.

ISTRAC (ISRO TELEMETRY TRACKING AND COMMAND NETWORK) is about the ground stations which are located at Bangalore, Lucknow, Mauritius, Sriharikota, Portblair Thiruvananthapuram and the deep space network stations.

Many Students said "WANT TO WORK IN ISRO" due to the inspiration. We expressed our thanks to the management of kits, principal, head of the department of ECE/CSE who permitted us to go on the visit, the faculty members who accompanied us and the officials who explained about the various departments on behalf of the students we request you to arrange more industrial visit for students which can practically train the students.



*[Handwritten Signature]*  
PRINCIPAL

Vignans Institute of Management & Technology For Women  
Kondapur(V), Ghatkesar(M), Medchal-Malkajgiri(Dt)-501301  
Telangana State



*Vignas*

PRINCIPAL

Vignas's Institute of Management & Technology For Women  
 Kondapur(V), Ghatewar(M), Medchal-Meikalgiri(Dt)-501301  
 Telangana State



**"Industrial Visit Collaborated with Edify path" Attendance List**

1	16UPIA05A9	Vuppala Keerthi Reddy
2	18UPIA0542	Rapolu Chandana
3	19UPIA0501	Alladi Ashwitha
4	19UPIA0502	Allakattu Pranusha
5	19UPIA0503	Ammula Tejaswi
6	19UPIA0504	Bejagam Bhavana
7	19UPIA0505	Bhoopathi Deepthi
8	19UPIA0506	Bogu Vyshnavi
9	19UPIA0507	Chamanthula Tejaswiri
10	19UPIA0508	Chikati Likhitha
11	19UPIA0509	Chunchu Varshini Yadav
12	19UPIA0510	G.Akankasha
13	19UPIA0511	Gaddam Akshitha
14	19UPIA0512	Gaddam Joshitha
15	19UPIA0513	Gardas Nikhitha
16	19UPIA0514	Garre Preethi
17	19UPIA0515	Guddeti Manognya
18	19UPIA0516	Kandul Nethra
19	19UPIA0517	Kankanala Harika
20	19UPIA0518	Karnampally Niharika Reddy
21	19UPIA0519	Karanti Chandra Lekha
22	19UPIA0520	Komati Reddy Shreya Reddy
23	19UPIA0521	Komati Reddy Sowjanya
24	19UPIA0522	Kovuri Radha
25	19UPIA0523	Kuntigorla Tejaswini
26	19UPIA0524	Kyatham Pravalika
27	19UPIA0525	Likitha Pawar
28	19UPIA0526	M Gouthami
29	19UPIA0527	Maradugu Poojitha
30	19UPIA0528	Monica Mahendra Nunsavath
31	19UPIA0529	Moddasani Sneharshitha
32	19UPIA0530	Mylapally Amulya
33	19UPIA0531	N Soniya
34	19UPIA0532	Nakirekanti Sathvika
35	19UPIA0533	Nalla Nithila
36	19UPIA0534	Nindanampally Vaishnavi
37	19UPIA0535	P Akhila
38	19UPIA0536	Pemmasani Sowmya



PRINCIPAL

Vignani's Institute of Management & Technology For Women  
Kondapur(V), Ghatkesar(M), Medchal-Malkajgiri(D)-501301  
Telangana State



# VIGNAN'S INSTITUTE OF MANAGEMENT AND TECHNOLOGY FOR WOMEN

Sponsored by Lavu Educational Society, Approved by AICTE, New Delhi & Affiliated to JNTUH, Hyderabad.  
Kondapur (V), Ghatkesar (M), Medchal - Malkajgiri (D) - 501 301 Phone: +91 96529 10002/3



39	19UP1A0537	Padala Prasanna Lahari
40	19UP1A0538	Pagadala Gayathri
41	19UP1A0539	Pati Srimukhi
42	19UP1A0540	Pittala Sanjana
43	19UP1A0541	Pola Amba Bhavani
44	19UP1A0542	Mansi Polaveni
45	19UP1A0543	Punem Keerthi
46	19UP1A0544	Rebbana Shivani
47	19UP1A0545	Rudroju Meghana
48	19UP1A0546	S Akshitha Bhavani
49	19UP1A0547	S Shravani Goud
50	19UP1A0548	Sandhireddy Meghana
51	19UP1A0549	Shailaja Arige
52	19UP1A0550	Varkala Sai Deepthi
53	19UP1A0551	Yeshaboina Shireesha
54	19UP1A0552	Akshanthala Sathvika
55	19UP1A0553	Andekar Easha
56	19UP1A0554	Annaldesi Sravika
57	19UP1A0555	Avutha Kiranmai
58	19UP1A0556	Ayiluri Sravani
59	19UP1A0557	Battar Gayatri Sravani
60	19UP1A0558	Beeravalli Swapna
61	19UP1A0559	Bethi Keerthana
62	19UP1A0560	Cheekati Kushitha
63	19UP1A0561	Cheruku Minisha
64	19UP1A0562	Devanoori Ushasri
65	19UP1A0563	Diddi Vasavi
66	19UP1A0564	Donda Jinganiya
67	19UP1A0565	Dontha Akshaya
68	19UP1A0566	Gajjala Anusha
69	19UP1A0567	Ganga Velakya
70	19UP1A0568	J.Meghana
71	19UP1A0569	Kandi Sriharshini
72	19UP1A0570	Karlapati Sreenija
73	19UP1A0571	Kommhneni Pooja Sri
74	19UP1A0572	K.Akshitha Reddy
75	19UP1A0573	Maddi Sreeja
76	19UP1A0574	Manthena Gouri
77	19UP1A0575	Meda Keerthana
78	19UP1A0576	Mettu Sankirithana
79	19UP1A0577	Mirapakayala Divya
80	19UP1A0578	Mohammad Afshin



  
PRINCIPAL  
Vignans Institute of Management & Technology For Women  
Kondapur(V), Ghatkesar(M), Medchal-Malkajgiri(D)-501301  
Telangana State



# VIGNAN'S INSTITUTE OF MANAGEMENT AND TECHNOLOGY FOR WOMEN

Sponsored by Laxmi Educational Society, Approved by AICTE, New Delhi & Affiliated to JNTUH, Hyderabad.  
Kondapur (V), Ghatkesar (M), Medchal - Malkajgiri (D) - 501 301 Phone: +91 98529 10002/3.



81	19UP1A0579	M Laxmi Prasanna
82	19UP1A0580	Myakala Pranayateja
83	19UP1A0581	Nadia Niloufer
84	19UP1A0582	Nagangar Rashika
85	19UP1A0583	Nagilla Sravani
86	19UP1A0584	Nangari Shirisha
87	19UP1A0585	Nutheti Rohini
88	19UP1A0586	Pagidi Pradeedthi
89	19UP1A0587	Pancherupula Shivani
90	19UP1A0588	Pendem Rechitha
91	19UP1A0589	Poonumalli Harshitha
92	19UP1A0590	Kallem Ruthika Reddy
93	19UP1A0591	Shivareddy Deepthi
94	19UP1A0592	Shaik Saba Sultana
95	19UP1A0593	Saini Sai Priya
96	19UP1A0594	Seelamsetty Roshini
97	19UP1A0595	Suhana
98	19UP1A0596	Syed Ayesha
99	19UP1A0597	Thopu Bhavya
100	19UP1A0598	Vadlamudi Samyuktha
101	19UP1A0599	Vakiti Hrithika
102	19UP1A05A0	Vempati Kavya
103	19UP1A05A1	Yallampally Neha
104	19UP1A05A2	Yenughanti Nikhitha



  
PRINCIPAL  
Vignans Institute of Management & Technology For Women  
Kondapur(V), Ghatkesar(M), Medchal-Malkajgiri(D)-501301  
Telangana State



Vignan's Institute of Management and Technology for Women  
Kondapur(V), Ghatkesar (M), Medchal(dt)

**Industrial Visit Feedback**

Name of Student Laxmi Purnasama

Semester III - II Group CSE - A Date of Visit 09-03-22

Name & Address of Company Visited SHAR

Tick the most appropriate option without any bias:

	Strongly Disagree			Strongly Agree
1. The visit was technology oriented	1	2	3	4 5
2. The program was applicable to my future needs	1	2	3	4 5
3. Enhancement in skills	1	2	3	4 5
4. The program was well placed within the allotted time	1	2	3	4 5
5. The Resource/Industry person was a good communicator	1	2	3	4 5
6. The material was presented in an organized manner	1	2	3	4 5
7. I would be interested in attending such visits in future	1	2	3	4 5
8. Any suggestions for improvement?				

\_\_\_\_\_  
\_\_\_\_\_

Please return this form to the coordinator.

Signature of student Laxmi Purnasama



Principal  
PRINCIPAL

Vignan's Institute of Management & Technology For Women  
Kondapur(V), Ghatkesar(M), Medchal-Malkajgiri(Dt)-501301  
Telangana State

Vignan's Institute of Management and Technology for Women  
Kondapur(V), Ghatkesar (M), Medchal(dt)

**Industrial Visit Feedback**

Name of Student Suhana  
Semester III - II Group CSE - B Date of Visit 9/7/22  
Name & Address of Company Visited fact

Tick the most appropriate option without any bias:

	Strongly Disagree				Strongly Agree
1. The visit was technology oriented	1	2 ✓	3	4	5
2. The program was applicable to my future needs	1	2	3 ✓	4	5
3. Enhancement in skills	1	2	3	4 ✓	5
4. The program was well placed within the allotted time	1	2	3	4	5 ✓
5. The Resource/Industry person was a good communicator	1	2	3 ✓	4	5
6. The material was presented in an organized manner	1	2 ✓	3	4	5
7. I would be interested in attending such visits in future	1	2	3 ✓	4	5
8. Any suggestions for improvement?					

No

Please return this form to the coordinator.

Suhana  
Signature of student



[Signature]  
PRINCIPAL  
Vignan's Institute of Management & Technology For Women  
Kondapur(V), Ghatkesar(M), Medchal-Malkajgiri(Dt)-501301  
Telangana State



# VIGNAN'S INSTITUTE OF MANAGEMENT AND TECHNOLOGY FOR WOMEN

Sponsored by Lawu Educational Society, Approved by AICTE, New Delhi & Affiliated to INTUH, Hyderabad, Kondapur (V), Ghatkesar (M), Medchal - Malkajgiri (D) - 501 301 Phone: +91 98529 10002/3



VMTW/CSE/CIR/2021-22/II/04

Date: 07/02/2022

## CIRCULAR

This is to inform all the faculties and students that there is a Three-Day Workshop on “DevOps Technologies” scheduled on 10-02-2022 to 12-02-2022. In this regard students are instructed to attend the workshop without fail

### Copy to:

1. CEO for information,
2. All the Deans,
3. The HOD (CSE / ECE / EEE / IT / AIML / BSH),
4. IQAC,
5. Admin Office,
6. All Notice Boards,
7. Circulate to all Class Rooms,
8. File.



*[Signature]*  
PRINCIPAL  
PRINCIPAL

Vignans Institute of Management & Technology For Women  
Kondapur (V), Ghatkesar (M), Medchal-Malkajgiri (Dt)-501301  
Telangana State

*[Signature]*  
PRINCIPAL

Vignans Institute of Management & Technology For Women  
Kondapur (V), Ghatkesar (M), Medchal-Malkajgiri (Dt)-501301  
Telangana State



# VIGNAN'S INSTITUTE OF MANAGEMENT AND TECHNOLOGY FOR WOMEN

(Sponsored by Lavu Educational Society)

Approved by AICTE, New Delhi & Affiliated to JNTUH, Hyderabad.

Kondapur (V), Ghatkesar (M), Medchal - Malkajgiri (D) - 501 301



## DEPARTMENT OF COMPUTER SCIENCE AND ENGINEERING

# A THREE-DAY WORKSHOP ON DEVOPS TECHNOLOGIES

10<sup>TH</sup> - 12<sup>TH</sup> FEBRUARY, 2022 @ SEMINAR HALL



In association with:



Resource Person:  
**Dr. Shiram K. V.**  
Principal Consultant,  
Huawei Technologies.

Chief Patron:  
**Dr. Lavu Rathalah,**  
Chairman, Vignans Group.

Co-Patron:  
**Dr. G. Appareo Naidu,**  
Principal, VMTW.

Co-Ordinator:  
**Dr. P. Rajendra Prasad,**  
Associate Professor,  
Dept. of CSE.  
Cell: +91 98482 22067

Patron:  
**Mr. B. Shrawan,**  
CEO, Vignans Group.

Advisor:  
**Dr. A. Sudhir Babu,**  
Associate Professor & HOD,  
Dept. of CSE.



PRINCIPAL

Vignans Institute of Management & Technology For Women  
Kondapur(V), Ghatkesar(M), Medchal-Malkajgiri(D)-501301  
Telangana State



# VIGNAN'S INSTITUTE OF MANAGEMENT AND TECHNOLOGY FOR WOMEN

Sponsored by Laxmi Educational Society, Approved by AICTE, New Delhi & Affiliated to JNTUH, Hyderabad.  
Kondapur (V), Ghatkesar (M), Medchal - Malkajgiri (D) - 501 301 Phone: +91 96529 10002/3



## DEPARTMENT OF COMPUTER SCIENCE AND ENGINEERING

Date: 15-02-2022

### Report on "DevOps Technologies"

**Type of Program:** Workshop

**Date:** 10-02-2022 to 12-02-2022

**No. of Students Participated:** 117

**Faculty Coordinator:** Mr.Dr.P.Rajendra Prasad

**Resource Person:** Mr.Dr.Shriram K.V

Principal Consultant, Huawei Technologies.

**Objective:** Understanding DevOps Principles, DevOps Benefits, DevOps Tools and Technologies

**Outcomes:** In this three-day training program the student were able to acquire knowledge of Advanced DevOps Technologies. They were able to design solutions for complex engineering problems like creating, selecting, and applying appropriate techniques, resources, and modern engineering IT tools



  
COORDINATOR



  
PRINCIPAL  
Vignan's Institute of Management & Technology For Women  
Kondapur(V), Ghatkesar(M), Medchal-Malkajgiri(D)-501301  
Telangana State

  
H.O. D  
Head of The Department  
Computer Science and Engineering  
Vignan's Institute of Management & Technology For Women  
Kondapur (V), Ghatkesar (M), Medchal-Malkajgiri (D)-501301  
Telangana State

## Workshop on DevOps Technologies

Course Instructor :Dr. Shriram K.V

S.No	Roll No	Name	10-Feb	11-Feb	12-Feb
1	186P1A0539	R Sri Vaishnavi	Sri Vaishnavi	Sri Vaishnavi	Sri Vaishnavi
2	18C21A0501	AavulaSwetha	Swetha	Swetha	Swetha
3	18C21A0520	Konda Raga Sudha	Raga Sudha	Raga Sudha	Raga Sudha
4	18C21A0522	KurakulaSrilekha	Srilekha	Srilekha	Srilekha
5	18C21A0561	PuttaPrathyusha	Prathyusha	Prathyusha	Prathyusha
6	18UP1A0501	Anreddy Pooja Sree	Pooja	Pooja	Pooja
7	18UP1A0502	Are Sadhana	Sadhana	Sadhana	Sadhana
8	18UP1A0503	AvulaKavya Sri	Kavya	Kavya	Kavya
9	18UP1A0504	BalneUnvitha	Unvitha	Unvitha	Unvitha
10	18UP1A0505	BandaruPranathi	Pranathi	Pranathi	Pranathi
11	18UP1A0506	BellamkondaVyshnavi	Vyshnavi	Vyshnavi	Vyshnavi
12	18UP1A0507	ChallaMahima Chandra	Chandaa	Chandaa	Chandaa
13	18UP1A0508	DasariRuchitha	Ruchitha	Ruchitha	Ruchitha
14	18UP1A0509	DeekondaRaagaPriya	Raaga Priya	Raaga Priya	Raaga Priya
15	18UP1A0510	DevandlaSwapna	Swapna	Swapna	Swapna
16	18UP1A0511	DevishettiAshritha	Ashritha	Ashritha	Ashritha
17	18UP1A0512	ElitiNandini	Nandini	Nandini	Nandini
18	18UP1A0513	GujjaHarshitha Reddy	Harshitha	Harshitha	Harshitha
19	18UP1A0514	GajulaVidya	Vidya	Vidya	Vidya
20	18UP1A0515	Guntur Komali	Komali	Komali	Komali
21	18UP1A0516	JeeyarPrasanna	Prasanna	Prasanna	Prasanna
22	18UP1A0517	K Rishika	Rishika	Rishika	Rishika
23	18UP1A0519	KandakatlaNavya	Navya	Navya	Navya
24	18UP1A0520	KappariSowmya	Sowmya	Sowmya	Sowmya
25	18UP1A0521	Karla Keerthana	Keerthana	Keerthana	Keerthana
26	18UP1A0522	KoppuAlekhyia	Alekhyia	Alekhyia	Alekhyia
27	18UP1A0523	KothaSravani	Sravani	Sravani	Sravani
28	18UP1A0524	M.Sravani	Sravani	Sravani	Sravani
29	18UP1A0525	MiriyalaReshika	Reshika	Reshika	Reshika
30	18UP1A0526	MoluguManasa	Manasa	Manasa	Manasa
31	18UP1A0527	MukkaMahima	Mahima	Mahima	Mahima
32	18UP1A0528	MullapudiYoshnavi Naga Lakshmi	Naga Lakshmi	Naga Lakshmi	Naga Lakshmi
33	18UP1A0529	Muppalla Sai Sree	Sai Sree	Sai Sree	Sai Sree
34	18UP1A0530	NangunuriAkhila	Akhila	Akhila	Akhila
35	18UP1A0531	NeelamVineela	Vineela	Vineela	Vineela



*[Signature]*  
PRINCIPAL

Vignans Institute of Management & Technology For Women  
Kondapur(V), Ghatkesar(M), Medchal-Malkajgiri(Dt)-501301  
Telangana State

36	18UP1A0532	NeeluriRishita	Rishita	Rishita	Rishita
37	18UP1A0533	PalvaiNikhitha	Nikhitha	Nikhitha	Nikhitha
38	18UP1A0534	PanjalaChandana	chandana	chandana	chandana
39	18UP1A0536	PashamShravani	shravani	shravani	shravani
40	18UP1A0537	Pasunuti Sindhu	Sindhu	Sindhu	Sindhu
41	18UP1A0538	Neeharika Patel	Nee Patel	Nee Patel	Nee Patel
42	18UP1A0539	Pothureddypallilkyatha	pullikya	pullikya	pullikya
43	18UP1A0540	Raju Bindu	Bindu	Bindu	Bindu
44	18UP1A0541	RaparathiSathvika	Sathvika	Sathvika	Sathvika
45	18UP1A0543	S Meghana	Megha	Megha	Megha
46	18UP1A0544	Sai MounikaViyyapu	Sai	Sai	Sai
47	18UP1A0545	SankaRamasai	Ramasai	Ramasai	Ramasai
48	18UP1A0546	SingaramPriyanshi	Priyanshi	Priyanshi	Priyanshi
49	18UP1A0547	SuryadevaraManeesha	Maneesha	Maneesha	Maneesha
50	18UP1A0548	Telukutla Priyanka	Priyanka	Priyanka	Priyanka
51	18UP1A0549	TalapalliSahithi	sahithi	sahithi	sahithi
52	18UP1A0550	NikhithaThumula	Nikhitha	Nikhitha	Nikhitha
53	18UP1A0551	VenakadasulaSravanapragathi	pragathi	pragathi	pragathi
54	18UP1A0552	V Shravya	shravya	shravya	shravya
55	18UP1A0553	Vemula Sai Esha	Esha	Esha	Esha
56	18UP1A0554	VollojuJagadeshwari	Jayam	Jayam	Jayam
57	18UP1A0555	VunnamSushmithasiri	S	S	S
58	18UP1A0556	VorugantiRochishna	Rof	Rof	Rof
59	18UP1A0557	ManepalliEswari Sai Sarayu	sarayu	sarayu	sarayu
60	18UP1A0558	Indela Dharani	Dharani	Dharani	Dharani
61	18UP1A0559	AchallaYagnamukhi	Yagnamukhi	Yagnamukhi	Yagnamukhi
62	18UP1A0560	AlapatiHarshini	Harshini	Harshini	Harshini
63	18UP1A0561	AnkamJaswitha	J	J	J
64	18UP1A0562	ArvapalliBhagyaChandana	chandana	chandana	chandana
65	18UP1A0563	BathinaHarshitha	Harshitha	Harshitha	Harshitha
66	18UP1A0564	Bheemaraju Lakshmi Manasa	L	L	L
67	18UP1A0565	Bojja Priyanka	Priyanka	Priyanka	Priyanka
68	18UP1A0566	BramanapallySupriya	Supriya	Supriya	Supriya
69	18UP1A0567	CheeliSwetha	Swetha	Swetha	Swetha
70	18UP1A0568	ChilamAnuradha	Anuradha	Anuradha	Anuradha
71	18UP1A0569	ChiralaRamya	Ramya	Ramya	Ramya
72	18UP1A0570	DamsaniSrija	Srija	Srija	Srija
73	18UP1A0571	GundaAbhi Sri	Abhisri	Abhisri	Abhisri
74	18UP1A0572	GandhamallaHemaLatha	Hema	Hema	Hema



*[Signature]*  
PRINCIPAL

Vignana's Institute of Management & Technology For Women  
Kondapur(V), Ghattkesar(M), Medchal-Malkajgiri(Dt)-501301  
Telangana State

75	18UP1A0573	GollapudiLikhita	Likhita	Likhita	Likhita
76	18UP1A0574	GuttaLathikaChowdary	Lathika	Lathika	Lathika
77	18UP1A0575	J LalithaPriya	Priya	Priya	Priya
78	18UP1A0576	JillalaMysasree	Sree	Sree	Sree
79	18UP1A0577	Kallutla Jaya Sindhuri	Sindhuri	Sindhuri	Sindhuri
80	18UP1A0578	KorrapatiMrudhula	Mrudhula	Mrudhula	Mrudhula
81	18UP1A0579	Kota VasaviVineetha	Vasavi	Vasavi	Vasavi
82	18UP1A0580	KothaSrinidhi	Srinidhi	Srinidhi	Srinidhi
83	18UP1A0581	Manepalli Pooja Sai Sree	Sai	Sai	Sai
84	18UP1A0582	MachanAnuksha	Anuksha	Anuksha	Anuksha
85	18UP1A0583	MadishettyManasa	Manasa	Manasa	Manasa
86	18UP1A0584	MatrojuShravya	Shravya	Shravya	Shravya
87	18UP1A0585	MedhireddySharanya Reddy	Sharanya	Sharanya	Sharanya
88	18UP1A0586	MethukulaHarshitha Mahesh	Harshitha	Harshitha	Harshitha
89	18UP1A0587	Miryala Pooja	Pooja	Pooja	Pooja
90	18UP1A0588	N Naga Deepthi	Deepthi	Deepthi	Deepthi
91	18UP1A0589	NarikondaBhanusree	Bhanusree	Bhanusree	Bhanusree
92	18UP1A0590	NeelaAkhila	Akhila	Akhila	Akhila
93	18UP1A0591	Neelapala Monika	Monika	Monika	Monika
94	18UP1A0592	NecradiPravalika	Pravalika	Pravalika	Pravalika
95	18UP1A0593	P Hemalatha	Hemalatha	Hemalatha	Hemalatha
96	18UP1A0595	RaaviHarshitha	Harshitha	Harshitha	Harshitha
97	18UP1A0596	RakkireddyVinitha	Vinitha	Vinitha	Vinitha
98	18UP1A0597	RanguSushma	Sushma	Sushma	Sushma
99	18UP1A0598	RenikindiRidhima	Ridhima	Ridhima	Ridhima
100	18UP1A0599	Sainikhitha	Nikhitha	Nikhitha	Nikhitha
101	18UP1A05A0	SakkirollaSriraga	Sriraga	Sriraga	Sriraga
102	18UP1A05A1	SamalaAkshitha	Akshitha	Akshitha	Akshitha
103	18UP1A05A2	Sangeetha	Sangeetha	Sangeetha	Sangeetha
104	18UP1A05A3	SavalamBhavani	Bhavani	Bhavani	Bhavani
105	18UP1A05A4	Shaista Sameen	Sameen	Sameen	Sameen
106	18UP1A05A5	SiliveriRasagnya	Rasagnya	Rasagnya	Rasagnya
107	18UP1A05A6	Somarouthu Sai Niharika	Niharika	Niharika	Niharika
108	18UP1A05A7	Sri Vani Madhav	Madhav	Madhav	Madhav
109	18UP1A05A8	TadisettiSravya	Sravya	Sravya	Sravya
110	18UP1A05A9	ThandarPalliSwathi	Swathi	Swathi	Swathi
111	18UP1A05B0	UppuluriBharathi	Bharathi	Bharathi	Bharathi
112	18UP1A05B1	VemulaPavani	Pavani	Pavani	Pavani
113	18UP1A05B2	VeniamuriNavya	Navya	Navya	Navya



PRINCIPAL  
Vignans Institute of Management & Technology For Women  
Kondapur (V), Ghatkesar (M), Medchal, Malkajgiri (D), Pin-501301, TS  
Telangana State



114	18UP1A05B3	Yamajala Sai Venkata Naga Sriya	Sai Venkata	Sai Venkata	Sai Venkata
115	18UP1A05B4	Yerukala Nuthana	Devi	Devi	Devi
116	19UP5A0501	Palle Kavya	Kavya	Kavya	Kavya
117	19UP5A0502	Sevella Sravanthi	Sri	Sri	Sri



  
 PRINCIPAL  
 Vignaa's Institute of Management & Technology For Women  
 Kondapur(V), Ghatkesar(M), Medchal-Malkajgiri(D)-501301  
 Telangana State



# VIGNAN'S INSTITUTE OF MANAGEMENT AND TECHNOLOGY FOR WOMEN

(Sponsored by Lavu Educational Society)

Approved by AICTE, New Delhi & Affiliated to JNTUH, Hyderabad.

Kondapur (V), Ghatkesar (M), Medchal - Malkajgiri (D) - 501 301

Accredited By



In association with:



## CERTIFICATE OF PARTICIPATION

This is to certify that Ms.

*M. Pooja Sai Sree*

has participated in A THREE-DAY WORKSHOP

**"DEVOPS TECHNOLOGIES"** held from 10<sup>th</sup> - 12<sup>th</sup> February, 2022,

Organized by the Department of Computer Science and Engineering,

in association with HUAWEI, Hyderabad, INDIA.

*[Signature]*  
Co-Ordinator



*[Signature]*  
HoD, CSE

*[Signature]*  
PRINCIPAL  
Vignans Institute of Management & Technology For Women  
Kondapur (V), Ghatkesar (M), Medchal-Malkajgiri (Dt.)-501301  
Telangana State

*[Signature]*  
Principal



# VIGNAN'S INSTITUTE OF MANAGEMENT AND TECHNOLOGY FOR WOMEN

Sponsored by Lawu Educational Society, Approved by AICTE, New Delhi & Affiliated to JNTUH, Hyderabad.  
Kondapur (V), Ghatkesar (M), Medchal - Malkajgiri (D) - 501 301 Phone: +91 96529 10002/3



VMTW/CSE (AI & ML)/CIR/2021-22/1/03

Date: 01/11/2021

## CIRCULAR

This is to inform all the faculties and students that there is a Three-Days Workshop on "Python Programming for Real world Applications" scheduled on 04-11-2021 to 06-11-2021. In this regard students are instructed to attend the workshop without fail.

  
PRINCIPAL

PRINCIPAL  
Vignani's Institute of Management & Technology For Women  
Kondapur (V), Ghatkesar (M), Medchal-Malkajgiri (Dt)-501301  
Telangana State

Copy to:

1. CEO for information,
2. IQAC,
3. Admin Office,
4. HODs (CSE, IT, ECE, EEE, BSH),
5. All Notice Boards
6. Circulate to all Class Rooms
7. File.



  
PRINCIPAL  
Vignani's Institute of Management & Technology For Women  
Kondapur (V), Ghatkesar (M), Medchal-Malkajgiri (Dt)-501301  
Telangana State



# VIGNAN'S INSTITUTE OF MANAGEMENT AND TECHNOLOGY FOR WOMEN

(Sponsored by Lavu Educational Society)  
Approved by AICTE, New Delhi & Affiliated to JNTUH, Hyderabad.  
Kondapur (V), Ghatkesar (M), Medchal - Malkajgiri (D) - 501 301



DEPARTMENT OF CSE (ARTIFICIAL INTELLIGENCE AND MACHINE LEARNING)

## A WORKSHOP ON **PYTHON PROGRAMMING FOR REAL-WORLD APPLICATIONS**

**4<sup>th</sup> - 6<sup>th</sup> NOVEMBER, 2021 @ SEMINAR HALL**



Resource Person:  
**Mr. B. Bhanu Prakash,**  
Managing Director,  
Edugene Technologies Pvt. Ltd.  
Hyderabad.



In association with:



Chief Patron:  
**Dr. Lavu Rathaiah,**  
Chairman, Vignan Group.

Patron:  
**Mr. B. Shravan,**  
CEO, Vignan Group.

Co-Patron:  
**Dr. G. Apparao Naidu,**  
Principal, VMTW.

Advisor:  
**Dr. S. Rangaswamy,**  
Associate Professor & HOD,  
Dept. of CSE (AI&ML).

Co-Ordinator:  
**Mr. G. Rajesh,**  
Assistant Professor,  
Dept. of CSE (AI&ML),  
Cell: +91 96529 10003



  
PRINCIPAL  
Vignan's Institute of Management & Technology For Women  
Kondapur (V), Ghatkesar (M), Medchal-Malkajgiri (D) - 501 301  
Telangana State



09-11-2021

**DEPARTMENT OF CSE(AI & ML)**

**Report on**

**Python Programming for Real world Applications**

**Type of Program:** Workshop

**Date:** 04-11-2021 to 06-11-2021

**No. of Students Participated:** 54

**Faculty Coordinator:** Mr.G.Rajesh

**Resource Person:** Mr. Bandi Bhanu Prakash

Technical Lead,

Edugene Technologies Private Limited

**Objective:**

The workshop aimed Python programming is intended for students, who wish to learn the Python programming language. For present and future reference we discussed sample productive materials focusing the subject and application areas of the technology. We discussed product design, development and related services with end-to-end solutions in network.



**Outcomes:**

The workshop on "Python Programming for Real world Applications" provided participants with valuable insights into Python development. The students were given an insight into the relevant real time examples of python programming. The students were able to understand techniques and tools used.

  
COORDINATOR



  
PRINCIPAL  
Vignan's Institute of Management & Technology For Women  
Kondapur (V), Ghatkesar (M), Medchal-Malkajgiri (D)-501301  
Telangana State

  
H.O.D

Head of the Department  
Computer Science and Engineering (AI & ML)  
Vignan's Institute of Management & Technology For Women  
Kondapur (V), Ghatkesar (M), Medchal-Malkajgiri (D)-501301

36	20UP1A6636	Reddy Sushmitha	Sushmitha	Sushmitha	Sushmitha
37	20UP1A6637	Regatte Bhavana Reddy	-AB-	-AB-	Bhavana
38	20UP1A6638	Repala Sindhura	Sindhura	Sindhura	Sindhura
39	20UP1A6639	S D L Tanuja	Tanuja	Tanuja	Tanuja
40	20UP1A6640	Salkuti Keerthi Reddy	Keerthi	Keerthi	-AB-
41	20UP1A6641	Shaini Dutta	Shaini	-AB-	Shaini
42	20UP1A6642	Shavva Charitha Sri	-AB-	Charitha	-AB-
43	20UP1A6643	Sheela Himabindu	Himabindu	Himabindu	Himabindu
44	20UP1A6644	Vaddarapu Akshaya	Akshaya	Akshaya	Akshaya
45	20UP1A6645	Vajrala Sai Naga Akshitha Vardhani	-AB-	Akshitha	Akshitha
46	20UP1A6646	Vode Rashmitha	Rashmitha	Rashmitha	Rashmitha
47	20UP1A6647	Yaramadha Deshwitha	Deshwitha	Deshwitha	Deshwitha
48	21UP5A6601	Akrati Panda	Panda	Panda	-AB-
49	21UP5A6602	Miriyala Sreeja	Sreeja	Sreeja	Sreeja
50	21UP5A6603	Nandikonda Akhila	Akhila	Akhila	Akhila
51	21UP5A6604	Pippalla Bhuvaneshwari	-AB-	Bhuvaneshwari	Bhuvaneshwari
52	21UP5A6605	Regulagadda Shivani	Shivani	-AB-	Shivani
53	21UP5A6606	Seelam Rohini	Rohini	Rohini	Rohini
54	21UP5A6607	Smruti Panda	Smruti	Smruti	Smruti

  
COORDINATOR

  
HOD-CSE (AI&ML)

Head of the Department  
Computer Science and Engineering (AI & ML)  
Vignani's Institute of Management & Technology For Women  
Kondapur (V), Ghatkesar (M), Medchal-Malkajgiri (Dt.)-501301



  
PRINCIPAL  
Vignani's Institute of Management & Technology For Women,  
Kondapur (V), Ghatkesar (M), Medchal-Malkajgiri (Dt.)-501301  
Telangana State

## Workshop on "Python Programming for Real world Applications"

Date: 04-11-2021 to 06-11-2021

S.No	Roll No	Student Name	04-Nov	05-Nov	06-Nov
1	20UPIA6601	Afreen Begum	Afreen	Afreen	Afreen
2	20UPIA6602	Anagandula Akanksha	Akanksha	Akanksha	Akanksha
3	20UPIA6603	Anumandla Neshitha	Neshitha	Neshitha	-AB-
4	20UPIA6604	Dokku Vatsalya	D. Vatsalya	D. Vatsalya	D. Vatsalya
5	20UPIA6605	Bandarupalli Sai Mounika	Sai Mounika	Sai Mounika	
6	20UPIA6606	Basetti Bhavani	B. Bhavani	B. Bhavani	B. Bhavani
7	20UPIA6607	Bikumalla Ashritha	Ashritha	Ashritha	Ashritha
8	20UPIA6608	Chavella Suchitra	Suchitra	Suchitra	Suchitra
9	20UPIA6609	Cherupally Prabandana	Prabandana	Prabandana	-AB-
10	20UPIA6610	Chintala Saranya	Saranya	-AB-	Saranya
11	20UPIA6611	Desala Likhitha Mahalaxmi	Mahalaxmi	Mahalaxmi	-AB-
12	20UPIA6612	Duda Shirisha	Shirisha	Shirisha	Shirisha
13	20UPIA6613	Edla Varsha Mudiraj	Varsha	-AB-	Varsha
14	20UPIA6614	Gavini Shravani	G. Shravani	G. Shravani	-AB-
15	20UPIA6615	Gonugunta Varshitha	Varshitha	-AB-	Varshitha
16	20UPIA6616	Gowrishetty Vaishnavi	Vaishnavi	Vaishnavi	Vaishnavi
17	20UPIA6617	Grandhe Venkata Laxmi Sreya	Laxmi Sreya	-AB-	Laxmi Sreya
18	20UPIA6618	Guduru Tvisha	Tvisha	Tvisha	Tvisha
19	20UPIA6619	Yellanki Vijaya Lakshmi	V. Lakshmi	-AB-	V. Lakshmi
20	20UPIA6620	Indalwai Likhitha Reddy	Likhitha	Likhitha	Likhitha
21	20UPIA6621	Kambhampati Sahithi	Sahithi	Sahithi	Sahithi
22	20UPIA6622	Kanuganti Anjani	Anjani	-AB-	-AB-
23	20UPIA6623	Katikam Akanksha	Akanksha	Akanksha	Akanksha
24	20UPIA6624	Kodali Praswika	Praswika	Praswika	Praswika
25	20UPIA6625	Konatham Lakshmi Thanmai	Lakshmi	-AB-	Lakshmi
26	20UPIA6626	Konduru Krupa	Krupa	Krupa	Krupa
27	20UPIA6627	Kothmeer Nruthika	Nruthika	Nruthika	-AB-
28	20UPIA6628	Lanka Nagavalli	Nagavalli	Nagavalli	Nagavalli
29	20UPIA6629	M Snehitha	Snehitha	Snehitha	Snehitha
30	20UPIA6630	Mallekuriki Sharon Keertana	Keertana	Keertana	Keertana
31	20UPIA6631	Malluru Sai Supriya	Sai Supriya	Sai Supriya	Sai Supriya
32	20UPIA6632	Manukonda Sruthi	Sruthi	-AB-	Sruthi
33	20UPIA6633	Nampally Akhila	Akhila	Akhila	Akhila
34	20UPIA6634	Nyayam Thanuja	Thanuja	Thanuja	Thanuja
35	20UPIA6635	Odala Akshaya	Akshaya	Akshaya	Akshaya



  
 PRINCIPAL  
 Institute of Management & Technology For Women  
 Kovvur (V), Ghadkesar (M), Medchal-Malkajgiri (D)-501301  
 Telangana State



# VIGNAN'S INSTITUTE OF MANAGEMENT AND TECHNOLOGY FOR WOMEN

(Sponsored by Lavu Educational Society)

Approved by AICTE, New Delhi & Affiliated to JNTUH, Hyderabad.

**Kondapur (V), Ghatkesar (M), Medchal - Malkajgiri (D) - 501 301**

Accredited By



NATIONAL BOARD OF ACCREDITATION

**CSE & ECE**

In association with:

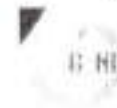

EDUGENE  
TECHNOLOGIES PVT. LTD.  
Specializing in Digital World

## CERTIFICATE OF PARTICIPATION

*This certificate is presented to Ms. ....D. Shrinisha.....  
for her participation in a workshop on "Python Programming for Real-world Applications" held from 4th -6th November, 2021. Organized by the Department of CSE (Artificial Intelligence & Machine Learning), in association with Edugene Technologies Pvt.Ltd., Hyderabad.*

*[Signature]*  
Co-Ordinator



*[Signature]*  
HoD, CSE (AI&ML)

*[Signature]*  
PRINCIPAL  
Vignans Institute of Management & Technology For Women  
Kondapur (V), Ghatkesar (M), Medchal-Malkajgiri (D)-501301  
Telangana State

*[Signature]*  
Principal





# VIGNAN'S INSTITUTE OF MANAGEMENT AND TECHNOLOGY FOR WOMEN

Sponsored by Lawu Educational Society, Approved by AICTE, New Delhi & Affiliated to INTUH, Hyderabad.  
Kondapur (V), Ghatkesar (M), Medchal - Malkajgiri (Dt) - 501 301 Phone: +91 96529 10002/3



VMTW/IT/CIR/2021-22/I/02

Date: 17/01/2022

## CIRCULAR

This is to inform all the faculties and students that there is a Three-Days Workshop on "**Quantum Computing**" scheduled on 20-01-2022 to 22-01-2022. In this regard students are instructed to attend the workshop without fail

  
**PRINCIPAL**

PRINCIPAL  
Vignan's Institute of Management & Technology For Women  
Kondapur (V), Ghatkesar (M), Medchal-Malkajgiri (Dt)-501301  
Telangana State

Copy to:

1. CEO for information,
2. IQAC,
3. Admin Office,
4. HODs (CSE, IT, ECE, EEE, BSH),
5. All Notice Boards
6. Circulate to all Class Rooms,
7. File.



  
**PRINCIPAL**

Vignan's Institute of Management & Technology For Women  
Kondapur (V), Ghatkesar (M), Medchal-Malkajgiri (Dt)-501301  
Telangana State



# VIGNAN'S INSTITUTE OF MANAGEMENT AND TECHNOLOGY FOR WOMEN

(Sponsored by Lavu Educational Society)  
Approved by AICTE, New Delhi & Affiliated to JNTUH, Hyderabad.  
Kondapur (V), Ghatkesar (M), Medchal - Malkajgiri (D) - 501 301



## DEPARTMENT OF INFORMATION TECHNOLOGY

### A WORKSHOP ON

# QUANTUM COMPUTING

20<sup>TH</sup> - 22<sup>ND</sup> JANUARY, 2022 @ SEMINAR HALL



Resource Person:  
**Mr. Prasad Kodukula,**  
Deputy General Manager -  
Talent Acquisition,  
Cyient Ltd, Hyderabad.

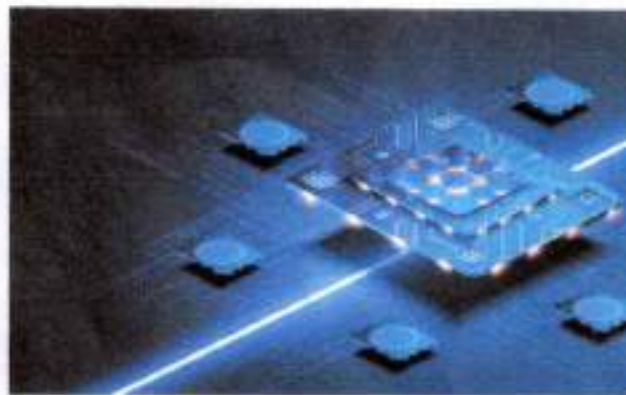

In association with:  
**CYIENT**

Chief Patron:  
**Dr. Lavu Rathaiah,**  
Chairman, Vignan Group.

Co-Patron:  
**Dr. G. Apparao Naidu,**  
Principal, VMTW.

Co-Ordinator:  
**Mr. K. Helini,**  
Assistant Professor, CSE.  
Cell: +91 96529 10002

Patron:  
**Mr. B. Shraavan,**  
CEO, Vignan Group.

Advisor:  
**Mr. B. Phijik,**  
Associate Professor & HOD,  
Dept. of IT.



*Handwritten signature*  
**PRINCIPAL**  
Vignan's Institute of Management & Technology For Women  
Kondapur (V), Ghatkesar (M), Medchal-Malkajgiri (D)-501301  
Telangana State



# VIGNAN'S INSTITUTE OF MANAGEMENT AND TECHNOLOGY FOR WOMEN

Sponsored by Lawu Educational Society, Approved by AICTE, New Delhi & Affiliated to JNTUH, Hyderabad.  
Kondapur (V), Ghatkesar (M), Medchal - Malkajiri (D) - 501 301 Phone: +91 98529 10002/3



25-01-2022

## DEPARTMENT OF INFORMATION TECHNOLOGY

### Report on

### QUANTUM COMPUTING

**Type of Program** : Workshop  
**Date** : 20-01-2022 to 22-01-2022  
**No. of Students Participated** : 47  
**Faculty Coordinator** : Mrs.K.Helini  
**Resource Person** : Mr. Prasad Kodukula  
 Technical Manager  
 Cyient Ltd

#### Objective:

The workshop aimed to familiarize participants with the fundamental concepts of quantum computing, its potential applications, and the current state of the field. The event consisted of lectures, hands-on activities, and discussions, providing a comprehensive learning experience.

#### Outcomes:

The workshop successfully introduced participants to the exciting field of quantum computing, providing them with a strong foundation in quantum mechanics, algorithms, and technologies. The hands-on activities and group discussions enhanced their understanding and fostered collaborative learning.



The workshop served as a stepping stone for further exploration and engagement with quantum computing, inspiring participants to pursue further study and research in the field.

**COORDINATOR**

*Helini*



**PRINCIPAL**  
Vignan's Institute of Management & Technology For Women  
Kondapur (V), Ghatkesar (M), Medchal-Malkajiri (D) - 501 301  
Telangana State

**H.O.D**

Head of the Department  
Information Technology  
Vignan's Institute of Management & Technology For Women  
Kondapur (V), Ghatkesar (M) Medchal-Malkajiri (Dt.)-501301

**Workshop on "Quantum Computing"**

**Date:20-01-2022 to 22-01-2022**

S.No	Roll No	Student Name	20-Jan	21-Jan	22-Jan
1	20UPIA1201	Appnaboina Laxmipriya	Priya	Priya	Priya
2	20UPIA1202	Atthili Santhoshi	Santhoshi	Santhoshi	Santhoshi
3	20UPIA1203	Bareddy Swetha Reddy	Swetha	Swetha	Swetha
4	20UPIA1204	Dokku Vatsalya	Vatsalya	Vatsalya	Vatsalya
5	20UPIA1205	Chintha Reddy Neha	Neha	Neha	Neha
6	20UPIA1206	Erukulla Prasanna	Prasanna	Prasanna	-A-
7	20UPIA1207	G Deepthi Sree	Deepthi	Deepthi	Deepthi
8	20UPIA1208	Gaddam Keerthi	Keerthi	Keerthi	-A-
9	20UPIA1209	Gaddam Sharanya	Sharanya	Sharanya	Sharanya
10	20UPIA1210	Gruddanti Preethi	Preethi	-A-	Preethi
11	20UPIA1211	Guntuku Rashmika	Rashmika	Rashmika	Rashmika
12	20UPIA1212	Jonnalagadda Sai Sri	Sai	Sai	Sai
13	20UPIA1213	Jukanti Anjali	Anjali	Anjali	Anjali
14	20UPIA1214	Jukanti Preethika	Preethika	Preethika	Preethika
15	20UPIA1215	K Sai Pavani	Pavani	Pavani	Pavani
16	20UPIA1216	Kadajji Sai Navyasree	Sai Navyasree	Sai Navyasree	Sai Navyasree
17	20UPIA1217	Kalluri Shresta Reddy	Shresta	-A-	Shresta
18	20UPIA1218	Kancharla Jahnvi	Jahnvi	Jahnvi	Jahnvi
19	20UPIA1219	Kandukuri Keerthi	Keerthi	Keerthi	Keerthi
20	20UPIA1220	Kandukuri Yuktha Reddy	Yuktha	Yuktha	Yuktha
21	20UPIA1221	Karnati Uma Maheshwari	Maheshwari	Maheshwari	Maheshwari
22	20UPIA1222	Karravula Pravallika	Pravallika	Pravallika	Pravallika
23	20UPIA1223	Kethineni Bhavya	Bhavya	-A-	Bhavya
24	20UPIA1224	Koppula Amulya Bharathi	Amulya	-A-	Amulya
25	20UPIA1225	Kotha Vidya	Vidya	Vidya	-A-
26	20UPIA1226	Kudipudi Niharika	Niharika	Niharika	Niharika



PRINCIPAL  
Vignani's Institute of Management & Technology For Women  
Kondapur (V), Ghatkesar (M), Medchal-Malkajgiri (Dt),  
Telangana State

27	20UP1A1227	Loka Sneha	Sneha	sneha	sneha
28	20UP1A1228	Madhira Kusuma	Kusuma	Kusuma	-A-
29	20UP1A1231	Nalla Likhitha	Likhitha	Likhitha	Likhitha
30	20UP1A1232	Paila Likhitha	Likhitha	Likhitha	Likhitha
31	20UP1A1233	Paritala Jyothika	Jyothika	Jyothika	Jyothika
32	20UP1A1234	Pendri Sri Varsha	Varsha	Varsha	Varsha
33	20UP1A1235	Podduturi Pranitha	Pranitha	Pranitha	Pranitha
34	20UP1A1236	Sunduru Sravani	Sravani	Sravani	Sravani
35	20UP1A1237	Terala Rithika	Rithika	Rithika	Rithika
36	20UP1A1238	Thammala Sahithi	Sahithi	Sahithi	-A-
37	20UP1A1239	Thuti Bhavana	-A-	Bhavana	Bhavana
38	20UP1A1240	Vakhil Nikhitha Reddy	Nikhitha	Nikhitha	Nikhitha
39	20UP1A1241	Veeramaneni Swapnika	Swapnika	Swapnika	Swapnika
40	20UP1A1242	Voleti Nandana	Nandana	Nandana	Nandana
41	20UP1A1243	Voleti Sreeja	Sreeja	Sreeja	Sreeja
42	20UP1A1244	Yadlapalli Swathi	Swathi	Swathi	Swathi
43	20UP1A1245	Yamavaram Anaga Swara	Anaga	Anaga	Anaga
44	21UP5A1201	Killada Bhargavi	Bhargavi	Bhargavi	Bhargavi
45	21UP5A1202	Maringanti Sri Sathvika	Sri	-A-	Sri
46	21UP5A1203	Maripala Manisha	Manisha	Manisha	Manisha
47	21UP5A1204	Swarna Niharika	Niharika	Niharika	Niharika

  
HOD-IT

Head of the Department  
Information Technology  
Vignans Institute of Management & Technology For Women  
Kondapur (V), Ghatkesar (M), Medchal-Malkajgiri (Dt.)-501301



  
PRINCIPAL  
Vignans Institute of Management & Technology For Women  
Kondapur (V), Ghatkesar (M), Medchal-Malkajgiri (Dt.)  
Telangana State



# VIGNAN'S INSTITUTE OF MANAGEMENT AND TECHNOLOGY FOR WOMEN

(Sponsored by Lavu Educational Society)

Approved by AICTE, New Delhi & Affiliated to JNTUH, Hyderabad.

**Kondapur (V), Ghatkesar (M), Medchal - Malkajgiri (D) - 501 301**

Accredited By



WOMEN EMPOWERMENT  
TECHNOLOGY INSTITUTE

**CSE & ECE**

In association with:

**CYIENT**

## CERTIFICATE OF PARTICIPATION

This certificate is presented to Ms. G. Shanmouja.....  
for her participation in a workshop on "Quantum Computing" held from  
20th - 22nd January, 2022. Organized by the Department of Information  
Technology, in association with Cyient, Hyderabad.

*Helini*  
Co-Ordinator



*[Signature]*  
HoD, IT

*[Signature]*  
PRINCIPAL

Vignans Institute of Management & Technology For Women  
Kondapur (V), Ghatkesar (M), Medchal-Malkajgiri (D)-501301  
Telangana State

*[Signature]*  
Principal



Date: 10-11-2021.

To  
The Branch Manager,  
StemWorld Innotech LLP  
Czech colony, Sanath nagar,  
Hyderabad-500018.

**Sub: Request for your kind permission to undergo internship - Reg.**

Dear Sir,

It gives me pleasure to share that, Vignans Institute of Management and Technology for Women, Hyderabad affiliated to JNTUH University established in year 2008. It is believed that the hands-on approach and experience in the various aspects of industry to enrich their knowledge of the students. In this context, the 4th year students are permitted to go companies to undergo internship which is also part of their curriculum. It is learnt that StemWorld Innotech LLP is offering online internships to engineering students in the area of **Internet of Things with Machine Learning**.

In this context request you to permit our students to do online internship in the StemWorld Innotech LLP.

The list of students is

S.No	Roll No	Student Name
1	18UP1A0549	Talapalli Sahithi
2	18UP1A0553	Vemula Sai Esha
3	18UP1A0534	Panjala Chandana
4	18UP1A0512	Eliti Nandini
5	18UP1A0514	Gajula Vidya
6	18UP1A0531	Neelam Vinela

Your consent is solicited at the earliest.

Thanking you Sir.

Yours Sincerely,

CSE-HOR

ASB

Head of The Department  
Computer Science and Engineering  
Vignans Institute of Management & Technology For Women  
Kondapur (V), Ghatkesar (M), Medchal-Malkajgiri (D)-501301  
Telangana State



PRINCIPAL  
Vignans Institute of Management & Technology For Women  
Kondapur (V), Ghatkesar (M), Medchal-Malkajgiri (D)-501301  
Telangana State

Date: 22-11-2021

**INTERNSHIP OFFER LETTER**

To  
The Head of the Department,  
Computer Science and Engineering,  
Vignan's Institute of Management and Technology for Women,  
Hyderabad.

Respected Sir,

We are pleased to intimate that we have a request from you IV year student's online internship training program in **Internet of Things with Machine Learning**. Here with we accept and permit your student to undergo training and the performance is evaluated and each student is certified. The students have to fulfill the regulations set by the organization.

S.No	Roll No	Student Name
1	18UPIA0553	VEMULA SAI ESHA
2	18UPIA0534	PANJALA CHANDANA
3	18UPIA0514	GAJULA VIDYA
4	18UPIA0531	NEELAM VINEELA

Thanking you

Yours Faithfully

Name: Mr. P. Gyandhwar  
Technical Manager  
Stem World Innotech LLP  
Hyderabad.

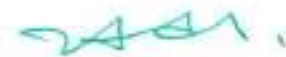
**PRINCIPAL**

**Vignan's Institute of Management & Technology For Women**  
Kondapur(V), Ghattkora(M), Medchal-Malkajgiri(Dt)-501301  
Telangana State



Date: 03-01-2022

To  
Vemula Sai Esha  
Vignan's Institute of Management and Technology for Women

## INTERNSHP CERTIFICATE

This is to certify that **Vemula Sai Esha** has successfully completed his internship program of 1 month with StemWorld Innotech LLP. She was working on **Internet of Things with Machine Learning** and was actively & diligently involved in the projects and tasks assigned to her. During the span we found her punctual and hardworking person. Her feedback and evolution proved that she is a quick learner.

Congratulations and Best Wishes.

Yours Faithfully,

  
Name: Mr. P. Ganeswar,  
Technical Manager,  
StemWorld Innotech LLP.



  
PRINCIPAL

Vignan's Institute of Management & Technology For Women  
Kondapur(V), Ghatkesar(M), Medchal-Malkajgiri(DT)-501301  
Telangana State

Date: 03-01-2022.

To  
Gajula Vidya  
Vignan's Institute of Management and Technology for Women.

## INTERNSHP CERTIFICATE

This is to certify that **Gajula vidya** has successfully completed his internship program of 1 month with StemWorld Innotech LLP. She was working on **Internet of Things with Machine Learning** and was actively & diligently involved in the projects and tasks assigned to her. During the span we found her punctual and hardworking person. Her feedback and evolution proved that she is a quick learner.

Congratulations and Best Wishes.

Yours Faithfully,

Name: Mr. P. Ganeswar  
Technical Manager  
StemWorld Innotech LLP.



  
**PRINCIPAL**  
Vignan's Institute of Management & Technology For Women  
Kondapur(V), Ghatkesar(M), Medchal-Malkajgiri(DI)-501301  
Telangana State

Date: 03-01-2022

To  
Panjala Chandana,  
Vignan's Institute of Management and Technology for Women.

## INTERNSHIP CERTIFICATE

This is to certify that **Panjala Chandana** has successfully completed his internship program of 1 month with StemWorld Innotech LLP. She was working on **Internet of Things with Machine Learning** and was actively & diligently involved in the projects and tasks assigned to her. During the span we found her punctual and hardworking person. Her feedback and evolution proved that she is a quick learner.

Congratulations and Best Wishes.

Yours Faithfully,

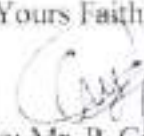
  
Name: Mr. P. G. Swar,  
Technical Manager,  
StemWorld Innotech LLP.



  
PRINCIPAL  
Vignan's Institute of Management & Technology For Women  
Kondapur(V), Chaiteswar(M), Medchal-Malkajgiri(D)-501301  
Telangana State

Date: 03-01-2022.

To  
Neelam Vineela,  
Vignan's Institute of Management and Technology for Women.

### INTERNSHP CERTIFICATE

This is to certify that **Neelam Vineela** has successfully completed his internship program of 1 month with StemWorld Innotech LLP. She was working on **Internet of Things with Machine Learning** and was actively & diligently involved in the projects and tasks assigned to her. During the span we found her punctual and hardworking person. Her feedback and evolution proved that she is a quick learner.

Congratulations and Best Wishes.

Yours Faithfully,

  
Name: Mr. P. Ganeswar,  
Technical Manager,  
StemWorld Innotech LLP.



  
**PRINCIPAL**  
Vignan's Institute of Management & Technology For Women  
Kondapur(V), Chevakesar(M), Medchal-Malkajgiri(Dt)-501301  
Telangana State

**Request for your kind permission to undergo internship**

Dept. of CSE VMTW <cse@vmtw.in>  
 Tue February, 8<sup>th</sup>, 2022 at 1:54 PM To: <deccansolutions@gmail.com>

Respected sir,

This is to inform you that the following students of our Computer science and Engineering, studying B.Tech IV year in Vignans's Institute of Management and Technology for Women, Hyderabad, affiliated to JNTUH University. I request you to permit them to avail the Internship Program at your organization.

The following are the student details are:

S. No	Roll Number	Name of the Student
1	18UPIA05A7	SRI VANI MADHAV
2	18UPIA0574	GUTTA LATHIKA CHOWDARY
3	18UPIA0585	JAGINI SHARANYA

We request you to consider the above students for internship at your esteemed organization.

Thanking you,

Thanks Regards  
 Dr.A. Sudhir Babu  
 Professor & HOD,  
 Dept. of CSE, VMTW



*Handwritten signature in green ink*  
 PRINCIPAL  
 Vignans's Institute of Management & Technology for Women  
 Kondapur(V), Chaitanya(M), Madchal-Malakajin(D)-501301  
 Telangana State

[Vignan's Institute of management and technology for women]  
[Kondapur (V), Ghatkesar(M),Medchal-Malkajgheri(D)]  
[Telangana, 501301]

[Subject: Approved for Internship]  
Dear [VMTW, CSE Dept],

Hence, further enhancement of students knowledge we have approved the organization to undergo internship, which is also part of their curriculum. It is learnt that Deccan Solution Pvt. Ltd is offering online internships to engineering students in the area of Artificial Intelligence.

Sincerely,  
Regards

Deccan Solutions,  
Mehidipatnam, Hyderabad,  
7670815985.



**PRINCIPAL**

Vignan's Institute of Management & Technology For Women  
Kondapur (V), Ghatkesar (M), Medchal-Malkajgheri (D), Pin-501301  
Telangana State



# DECCAN SOLUTIONS

20-April-2022

To  
Sri Vani Madhav  
Vignana's Institute of Management and Technology for women

## INTERNSHIP CERIFICATE

This is to certify that Sri Vani Madhav of IV-CSE has successfully completed her internship with Deccan Solutions. She has been working on Artificial Intelligence and was enthusiastically & meticulously involved in the projects and tasks assigned to her. She is punctual and working during the Internship.

Congratulations and Best Wishes.

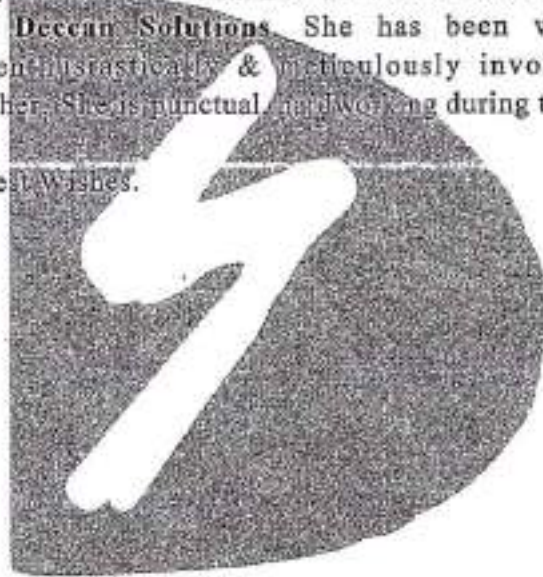

Yours Faithfully,



*[Handwritten Signature]*

**PRINCIPAL**  
Vignana's Institute of Management & Technology For Women  
Kondapur(V), Ghatkesar(M), Medchal-Malkajgiri(Dt)-501301  
Telangana State



# DECCAN SOLUTIONS

20-April-2022

To  
Gutta Lathika Chowdary  
Vignan's Institute of Management and Technology for women

## INTERNSHIP CERTIFICATE

This is to certify that Gutta Lathika Chowdary of IV-CSE has successfully completed her internship with Deccan Solutions. She has been working on Artificial Intelligence and was enthusiastically & meticulously involved in the projects and tasks assigned to her. She was punctual & hardworking during the Internship.

Congratulations and Best Wishes.

Yours Faithfully,



*[Handwritten Signature]*  
PRINCIPAL

Vignan's Institute of Management & Technology For Women  
Kondapur(V), Ghattkesar(M), Medchal-Malkajgiri(Dt)-501301  
Telangana State





# DECCAN SOLUTIONS

20-April-2022

To

Jagini Sharanya

Vignan's Institute of Management and Technology for women

## INTERNSHIP CERTIFICATE

This is to certify that Jagini Sharanya of IV-CSE has successfully completed her internship with Deccan Solutions. She has been working on Artificial Intelligence and was enthusiastically & meticulously involved in the projects and tasks assigned to her. She is punctual, hardworking during the internship.

Congratulations and Best Wishes.

Yours Faithfully,



*[Handwritten Signature]*

PRINCIPAL

Vignan's Institute of Management & Technology For Women  
Kothnagar(V), Ghatkesar(M), Medchal-Mahabubnagar(Dt)-501301  
Telangana State

**Request for your kind permission to internship**

Dept. of CSE VMTW <cse@vmtw.in>

Tue February, 22<sup>nd</sup>, 2022 at 11:54 AM To: <hrmceespl@gmail.com>

Respected sir,

This is to inform you that the following students of our Computer science and Engineering, studying B.Tech III year in Vignans Institute of Management and Technology for Women, Hyderabad, affiliated to JNTUH University. I request you to permit them to avail the Internship Program during the month of 1<sup>st</sup> March - 30<sup>th</sup> March 2022 at your organization.

The following are the student details are:

S. No	Roll Number	Name of the Student
1	19UPIA0529	MODDASANI SNEHARSHITHA
2	19UPIA0558	BEERAVALLI SWAPNA
3	19UPIA05C9	MOOLA.MANASA

We request you to consider the above students for internship at your esteemed organization.

Thanking you,

Thanks Regards  
 Dr.A. Sudhir Babu  
 Professor & HOD,  
 Dept. of CSE, VMTW



*[Handwritten Signature]*  
 Vignans Institute of Management & Technology for Women  
 Kondapur(V), Chaitanya(M), Medchal-Malkajgiri(DI)-501301  
 Telangana State

Regarding internship approval

MCEE SOLUTIONS PVT LTD <irmceesol@gmail.com>

28, February, 2022 at 10:05 AM

To: Dept. of CSE VMTW <cse@vmtw.in>

Sir/Madam,

Sub: approved for organizing internship

Hence further enhancement of students knowledge we have approved the organization to undergo internship which is also part of their curriculum. It is learnt that MCEE Solution Pvt. Ltd is offering online internships to engineering students in the area of Software Development & Java Programming.

With Regards,  
MCEE Solutions Pvt Ltd,  
Mehdipatnam, Hyderabad.  
8019505999.



*[Handwritten Signature]*  
**PRINCIPAL**  
Vignar's Institute of Management & Technology For W.  
Kundapur(V), Ghatkesar(M), Medchal-Malkajgiri(D)-501301  
Telangana State



# MCEE SOLUTIONS PRIVATE LIMITED

Date: 12-April-22

## INTERNSHIP COMPLETION CERTIFICATE

### TO WHOMSOEVER IT MAY CONCERN

This is to certify that **Moddasani Sneharshitha** has successfully completed internship from 1-March-22 to 30-March-22 with MCEE Solutions Private Limited. She was working on Software Development with Python Programming and was actively involved in the projects. During the internship tenure, she concluded the project with a commendable performance and a good conduct.

We wish her all the best for future endeavors!

Yours sincerely,

**Abdul Kareem,**  
MCEE Solutions Pvt.Ltd.



*[Handwritten Signature]*

PRINCIPAL

Vignana's Institute of Management & Technology for Women  
Kondapur(V), Ghatkesar(M), Medchal-Malkajgiri(DT)-501301  
Telangana State

# 503, 5<sup>th</sup> Floor, Manzil Chamber, Mehdiapatnam, Hyd.-28, T.S., INDIA.  
Tel. No. : +91 8019505999, E-mail: hrmceespl@gmail.com



# MCEE SOLUTIONS PRIVATE LIMITED

Date: 12-April-22

## INTERNSHIP COMPLETION CERTIFICATE

### TO WHOMSOEVER IT MAY CONCERN

This is to certify that **Beeravalli Swapna** has successfully completed internship from 1-March-22 to 30-March-22 with MCEE Solutions Private Limited. She was working on Software Development with Python Programming and was actively involved in the projects. During the internship tenure, she concluded the project with a commendable performance and a good conduct.

We wish her all the best for future endeavors.

Yours sincerely,

Mr. **M. Abdul Kareem**,  
Founder & CEO  
MCEE Solutions Pvt. Ltd.



*rsr*  
**PRINCIPAL**  
Vignans Institute of Management & Technology For Women  
Kondapur(V), Ghatkesar(M), Medchal-Malkajgiri(DT)-501301  
Telangana State

# 503, 5<sup>th</sup> Floor, Manzil Chamber, Mehdipatnam, Hyd.-28, T.S., INDIA.  
Tel. No. : +91 8019505999, E-mail: hrmceespl@gmail.com



# MCEE SOLUTIONS PRIVATE LIMITED

Date: 12-April-22

## INTERNSHIP COMPLETION CERTIFICATE

### TO WHOMSOEVER IT MAY CONCERN

This is to certify that **Moola.Manasa** has successfully completed internship from 1-March-22 to 30-March-22 with MCEE Solutions Private Limited. She was working on Software Development with Python Programming and was actively involved in the projects. During the internship tenure, she concluded the project with a commendable performance and a good conduct.

We wish her all the best for future endeavors.

Yours sincerely,

Mr. Mohammed Abdul Kareem,  
Founder & CEO  
MCEE Solutions Pvt.Ltd.



**PRINCIPAL**  
Vignans Institute of Management & Technology For Women  
Kondapur(V), Ghatkesar(M), Medchal-Malkajgiri(Dt)-501301  
Telangana State

# 503, 5<sup>th</sup> Floor, Manzil Chamber, Mehdiapatnam, Hyd.-28, T.S., INDIA.  
Tel. No. : +91 8019505999, E-mail: hrmceespl@gmail.com



VMTW/CRT/2021-22/1/02

Date: 21-10-2021.

**CIRCULAR**

All the HODs and Placement Coordinators are here by requested to inform III- B.Tech students that "**Campus Recruitment Training on Database Concepts**" will be conducted in our college starting from 25-10-2021 to 30-10-2021 for all third year IT students.

Contact T&P Cell for further information.

  
PRINCIPAL

PRINCIPAL

Vignan's Institute of Management & Technology For Women  
Kondapur (V), Ghatkesar (M), Medchal-Malkajgiri (D)-501301  
Telangana State

Copy to:

1. CEO, for his kind information.
2. All the Deans,
3. The HOD (CSE / ECE / EEE / IT / AIML / BSH)
4. IQAC.
5. Admin Office,
6. All Notice Boards,
7. Circulate to all Class Rooms,
8. File



  
PRINCIPAL

Vignan's Institute of Management & Technology For  
Kondapur (V), Ghatkesar (M), Medchal-Malkajgiri (D),  
Telangana State



Date: 01-11-2021

## Training and Placement Cell

**Name of the Programme:** Campus Recruitment Training

**Syllabus:** Normalization, Denormalization, SQL, NO-SQL, ERDS, Query optimization, Hierarchical database systems, Network database systems, Object oriented database systems.

**Objective:** To train the students in areas such as Normalization,denormalization, SQL,NO-SQL,ERDS, Query optimization, Hierarchical database systems, Network database systems, object oriented database systems and revolve around effectively managing and organizing data to support efficient and reliable data storage,retrieval,manipulation,analysis and soft skills to make them ready for placements.

**Name of the Organization:** Internshala, Scholiverse Educare Pvt.Ltd

**Dates of the program:** 25-10-2021 to 30-10-2021

**Number of students attended:** 35

**Resource Person:** Suman Tallada



**Outcome:** Students were trained in Database concepts like Normalization, denormalization, SQL,NO-SQL,ERDS, query optimization, Hierarchical database systems, Network database systems, Object oriented database making them ready for campus placements.

The undersigned thanked the respective department coordinators for their able support in completing the program successfully.



  
PRINCIPAL

Vignans Institute of Management & Technology For Women  
Kondapur (V), Ghatkesar (M), Medchal-Malkajgiri (D)-501301  
Telangana State

  
HOD-IT

Head of the Department  
Information Technology  
Vignans Institute of Management & Technology For Women  
Kondapur (V), Ghatkesar (M), Medchal-Malkajgiri (D)-501301  
Telangana State



Name of the Organization: Internshala,Scholoverse Educare Pvt.Ltd

Course instructor: Suman Tallada

**Training & Placement Cell**

**CRT Program Conducted by Internshala,Scholoverse Educare Pvt.Ltd**

S. No	Hall Ticket No	Name of the Candidate	Signature
1	19UP1A1201	A SANGEETHA	Sangeetha
2	19UP1A1202	ADELLI SAMYUKTHA REDDY	Adeelli
3	19UP1A1203	APURI SOWMYA	Apuri
4	19UP1A1204	B SHREYA REDDY	Shreya
5	19UP1A1205	BHASHETTY ANUSHA	Anusha
6	19UP1A1206	BEERAVALLY SAI JOSMITHA	Sai
7	19UP1A1207	BODDU SATHWIK	Sathwik
8	19UP1A1208	LAKSHMI SAHITI CHALAPATI	Lakshmi
9	19UP1A1209	GURRAM SNEHA REDDY	Sneha
10	19UP1A1210	JOGINIPELLY SAHITHYA	Sahitya
11	19UP1A1211	KASULA KEERTHI REDDY	Keerthi
12	19UP1A1212	KETHEPALLIGURUVENKATASAI	Ketha
13	19UP1A1213	KOMURAVELLY ASHWITHA	Ashwita
14	19UP1A1214	KOTHAKAPU NIHARIKA REDDY	Niharika
15	19UP1A1215	KS KRISHNA	Krishna
16	19UP1A1216	LINGAMPALLY NISHITHA	Nishitha
17	19UP1A1217	MALEM VASANTHI	Vasanthi
18	19UP1A1218	MAHANKALI PAVANI	Pavani
19	19UP1A1219	NAVYA TALASILA	Navya
20	19UP1A1220	PAILLA SONY	Sony
21	19UP1A1221	PALLERLA VENNELA	Vennela
22	19UP1A1222	PATHIPATI SHILPA	Shilpa
23	19UP1A1223	PENDAM VINEETHA	Vineetha
24	19UP1A1224	SANJANA SARASWATHI G	Sanjana
25	19UP1A1225	SRIDASYAM KEERTHI	Keerthi
26	19UP1A1226	SRIPATHI HARSHITHA	Harshitha
27	19UP1A1227	TURLAPATI RITHIKA	Rithika
28	19UP1A1228	TAMMALI MADHAVI	Madhavi
29	19UP1A1229	THOKALA SINDHU REDDY	Sindhu
30	19UP1A1230	TIRUKOVELA SRINIDHI	Srinidhi
31	19UP1A1231	TURLAPATI RUPIKA	Rupika
32	19UP1A1232	V AKSHITHA	Akshitha
33	19UP1A1233	VADDIREDDY MEGHANA	Meghana
34	19UP1A1234	VANGAVEETI SRAVANI	Sravani
35	20UP5A1201	BATTA SWAPNA	Swapna



*[Signature]*  
PRINCIPAL

Vignani's Institute of Management & Technology  
Kondapur (V), Ghatkesar (M), Medchal-Malkajgiri (D), 501301  
Telangana State

*[Signature]*  
Hod-IT

Head of the Department  
Information Technology

Vignani's Institute of Management & Technology For Women  
Kondapur (V), Ghatkesar (M), Medchal-Malkajgiri (D), 501301



# VIGNAN'S INSTITUTE OF MANAGEMENT AND TECHNOLOGY FOR WOMEN

Sponsored by Lawu Educational Society, Approved by AICTE, New Delhi & Affiliated to JNTUH, Hyderabad.  
Kondapur (V), Ghatkesar (M), Medchal - Malkajgiri (D) - 501 301 Phone: +91 96529 10002/3



VMTW/CSE/CIR/2021-22/II/02

Date: 19/04/2022

## CIRCULAR

We are happy to inform that there is a three days workshop on "Oracle Database Administrator" will be conducted for all the Faculties and students from 21-04-2022 to 23-04-2022. In this regard faculties and students are requested to enroll and participate in the workshop to make it successful.

  
PRINCIPAL

PRINCIPAL

Vignan's Institute of Management & Technology For Women  
Kondapur (V), Ghatkesar (M), Medchal-Malkajgiri (D)-501301  
Telangana State

Copy to:

1. CEO for information,
2. IQAC,
3. Admin Office,
4. HODs (CSE, IT, ECE, EEE, BSH),
5. All Notice Boards
6. Circulate to all Class Rooms,
7. File,

  
PRINCIPAL

Vignan's Institute of Management & Technology For Women  
Kondapur (V), Ghatkesar (M), Medchal-Malkajgiri (D)-501301  
Telangana State





# VIGNAN'S INSTITUTE OF MANAGEMENT AND TECHNOLOGY FOR WOMEN

(Sponsored by Lavu Educational Society)

Approved by AICTE, New Delhi & Affiliated to JNTUH, Hyderabad.

Kondapur (V), Ghatkesar (M), Medchal - Malkajgiri (D) - 501 301



## DEPARTMENT OF COMPUTER SCIENCE AND ENGINEERING

### A WORKSHOP ON

# ORACLE DATABASE ADMINISTRATOR

## 21<sup>ST</sup> - 23<sup>RD</sup> APRIL, 2022 @ SEMINAR HALL



Resource Person:

**Mr. Bandi Sreenath,**

Director,

Ambest Technovation Pvt. Ltd.  
Hyderabad.



### ORACLE DBA

In association with:



Chief Patron:

**Dr. Lavu Rathalah,**  
Chairman, Vignani Group.

Co-Patron:

**Dr. G. Apparao Naidu,**  
Principal, VMTW.

Co-Ordinator:

**Mr. M. Uday Kumar,**  
Assistant Professor, CSE.  
Cell: +91 96529 10002

Patron:

**Mr. B. Shraavan,**  
CEO, Vignani Group.

Advisor:

**Dr. S. Rangaswamy,**  
Associate Professor & HOD,  
Dept. of CSE.



*[Signature]*  
PRINCIPAL  
Vignani's Institute of Management & Technology For Women  
Kondapur (V), Ghatkesar (M), Medchal-Malkajgiri (D)-501301  
Telangana State



# VIGNAN'S INSTITUTE OF MANAGEMENT AND TECHNOLOGY FOR WOMEN

Sponsored by Lavu Educational Society, Approved by AICTE, New Delhi & Affiliated to JNTUH, Hyderabad.  
Kondapur (V), Ghalkesar (M), Medchal - Malkajgiri (D) - 501 301 Phone: +91 96529 10002/3



## DEPARTMENT OF COMPUTER SCIENCE AND ENGINEERING

### Report on "Oracle Database Administrator"

Date: 25-04-2022

<b>Event Type</b>	: Workshop
<b>Total No. of Participants</b>	: 93
<b>Resource Person</b>	: Bandi Sreenath, DBA, Ambest Technovation Private Limited, Hyderabad.
<b>Name of Coordinator</b>	: M.Udhay kumar
<b>Date &amp; Time</b>	: 21-4-2022 to 23-4-2022 10:00AM to 4:00PM

#### **Objective of the Event:**

The objective of an Oracle Database Administrator (DBA) is to ensure the smooth and efficient operation of Oracle database systems within an organization. The primary responsibilities of an Oracle DBA revolve around the management, maintenance, and optimization of Oracle databases to ensure data integrity, availability, and security. Here are some key objectives of an Oracle DBA:

#### **Outcomes of the Event:**

The outcomes of an Oracle Database Administrator (DBA) encompass various positive results and improvements that can be achieved through their efforts. Here are some key outcomes of an Oracle DBA:



**Stable and Reliable Database Environment:** A skilled Oracle DBA ensures the stability and reliability of the database environment. By implementing best practices, monitoring system performance, and promptly resolving issues, they minimize downtime, prevent data loss, and maintain the availability of critical systems.



  
PRINCIPAL  
Vignans Institute of Management & Technology For Women  
Kondapur (V), Ghalkesar (M), Medchal-Malkajgiri (D)-501301  
Telangana State



# VIGNAN'S INSTITUTE OF MANAGEMENT AND TECHNOLOGY FOR WOMEN

Sponsored by Lavu Educational Society, Approved by AICTE, New Delhi & Affiliated to JNTUH, Hyderabad.  
Kondapur (V), Ghatkesar (M), Medchal - Malkajgiri (D) - 501 301 Phone: +91 96529 10002/3



Total 93 Number of members and 6 numbers of Staff had participated in the workshop. This workshop session had provided an excellent opportunity to learn about **Oracle Database Administrator** to all the participants.

*Udaykumar*

**Coordinator**



*[Signature]*

**Head of Department**

Head of The Department  
Computer Science and Engineering  
Vignans Institute of Management & Technology For Women  
Kondapur (V), Ghatkesar (M), Medchal-Malkajgiri (D)-501301  
Telangana State

*[Signature]*

Vignans Institute of Management & Technology For Women  
Kondapur (V), Ghatkesar (M), Medchal-Malkajgiri (D)-501301  
Telangana State

**Student attendance list of three days workshop on Oracle Database Administrator**

**A.Y 2021-2022**

**II YEAR B.TECH (CSE)**

S.No	Roll No	STUDENT NAME	21-APR	22-APR	23-APR
1	16UP1A0580	Y Vishitha	<del>Vishitha</del>	<del>Vishitha</del>	Vishitha
2	17UP1A0501	A Sreshta	Shreshtha	shreshtha	shvesta
3	17UP1A0502	Annem Hari Priya	Priya	Priya	Priya
4	17UP1A0503	Ashala Harika	<del>Harika</del>	<del>Harika</del>	Harika
5	17UP1A0504	Bandla Saujanya	Saujanya	Saujanya	Saujanya
6	17UP1A0505	Bikkasani Renuka Chowdary	<del>Renuka</del>	<del>Renuka</del>	<del>Renuka</del>
7	17UP1A0506	Bourishetty Harika	Harika	Harika	A
8	17UP1A0507	Bulchur Ramesh Sankirtana	<del>Ramesh</del>	<del>Ramesh</del>	<del>Ramesh</del>
9	17UP1A0508	Cheepu Vineesha	Vineesha	vineesha	vineesha
10	17UP1A0509	Dasari Divya	Divya	Divya	Divya
11	17UP1A0510	Dubba Mounikareddy	Mouni	Mouni	Mouni
12	17UP1A0511	Gangula Megana	<del>Megana</del>	<del>Megana</del>	A
13	17UP1A0512	Godshala Vishalini	Vishalini	Vishalini	Vishalini
14	17UP1A0513	Gundrathi Siri Chandana	<del>Chandana</del>	<del>Chandana</del>	<del>Chandana</del>
15	17UP1A0514	Jakkam Jyothsna	<del>Jyothsna</del>	<del>Jyothsna</del>	<del>Jyothsna</del>
16	17UP1A0515	Jilla Shivani	<del>Shivani</del>	<del>Shivani</del>	A
17	17UP1A0516	Juluru Vyshnavi	Vyshna	Vyshna	Vyshna
18	17UP1A0517	K Ishwarya	<del>Ishwarya</del>	<del>Ishwarya</del>	<del>Ishwarya</del>
19	17UP1A0518	K Yashaswini	<del>Yashaswini</del>	<del>Yashaswini</del>	A
20	17UP1A0519	Kancharla Sarayu	Sarayu	Sarayu	Sarayu
21	17UP1A0520	Kanuganti Megala	Megala	Megala	Megala
22	17UP1A0521	Kasanagottu Yashaswini	Yashaswini	Yashaswini	Yashaswini
23	17UP1A0522	Kongara Kavya Sri	Kavya	Kavya	A



  
 PRINCIPAL  
 Women's Institute of Management & Technology For Women  
 Kondapur (V), Ghatkesar (M), Medchal-Malkajgiri (DI)-501301  
 Telangana State

24	17UP1A0523	Konyala Sravani	Sravani	Sravani	Sravani
25	17UP1A0524	Kosuri Praneetha	Praneetha	Praneetha	Praneetha
26	17UP1A0525	Kuthru Vishnava	Vishnava	Vishnava	A
27	17UP1A0526	Maduri Vaishnavi	A	Vaish	Vaish
28	17UP1A0527	Mudiraj Ramya	Ramya	A	Ramya
29	17UP1A0528	Nallaboina Muniswathi	Swathi	Swathi	A
30	17UP1A0529	Nandagiri Shruthi	Shruthi	Shruthi	Shruthi
31	17UP1A0530	Nayini Priyanka	Priyanka	Priyanka	Priyanka
32	17UP1A0531	Nidanampally Spoorthy	Spoorthy	A	Spoorthy
33	17UP1A0532	Nune Bhargavi	Bhargavi	Bhargavi	A
34	17UP1A0533	Padala Sri Satya	Satya	Satya	A
35	17UP1A0534	Palla Madhuri	Madhuri	Madhuri	Madhuri
36	17UP1A0535	Pendyam Shivali Sagar	Shivali	Shivali	Shivali
37	17UP1A0536	Pesara Chaithanya	Chaithanya	Chaithanya	Chaithanya
38	17UP1A0537	Polagouni Shivani	Shivani	Shivani	Shivani
39	17UP1A0538	Pottumuttu Vaishnavi	Vaishnavi	Vaishnavi	Vaishnavi
40	17UP1A0539	Preetika Kuntala	Kuntala	A	Kuntala
41	17UP1A0540	Punna Umabharathi	Uma	Uma	Uma
42	17UP1A0541	Rasamalla Savitha	Savitha	Savitha	A
43	17UP1A0542	Samudrala Rajyalaxmi	Laxmi	Laxmi	A
44	17UP1A0543	Shruti	Shruti	Shruti	Shruti
45	17UP1A0544	Sirpur Pooja	Pooja	Pooja	Pooja
46	17UP1A0545	Soma Shivani	Shivani	Shivani	Shivani
47	17UP1A0546	Surabhi Saipriya	Sai	Sai	Sai
48	17UP1A0547	Susma Chittanori	Susma	Susma	Susma
49	17UP1A0548	Thakur Sai Priya	Saipriya	Saipriya	Saipriya
50	17UP1A0549	Vallapu Swathika	Swathika	Swathika	Swathika
51	17UP1A0550	Yadavalli Sowjanya	Sowjanya	Sowjanya	Sowjanya



PRINCIPAL  
Vignani's Institute of Management & Technology For Women  
Kondapur (V), Ghatkesar (M), Medchal-Malkajgiri (OT)-501301  
Telangana State

52	17UP1A0551	Akula Tejaswini	Teja	Tejas	Teja
53	17UP1A0552	Anagandula Shashanka	Shashanka	Shashanka	Shashanka
54	17UP1A0553	Anagani Gnanasri	Gnanasri	Gnanasri	Gnanasri
55	17UP1A0554	Ankitha Kulkarni	Kulkarni	Kulkarni	Kulkarni
56	17UP1A0555	Annarthi Manasa Devi	Devi	Devi	Devi
57	17UP1A0556	B.Preethi	Preethi	Preethi	Preethi
58	17UP1A0557	Bandi Sarala	Saral	Saral	Saral
59	17UP1A0558	Borru Bhargavi	Bhargavi	A	Bhargavi
60	17UP1A0559	Chigurupati Pooja	Pooja	Pooja	Pooja
61	17UP1A0560	Desidi Akshith	Akshith	Akshith	Akshith
62	17UP1A0561	Devaraju Kiranmayi	Kiranmayi	Kiranmayi	A
63	17UP1A0562	E Deepika	Deepika	Deepika	Deepika
64	17UP1A0563	G J K Keerthana	Keerthana	Keerthana	Keerthana
65	17UP1A0564	G Sowmya	Sowmya	Sowmya	Sowmya
66	17UP1A0565	Gade Swarupa	Swarupa	Swarupa	Swarupa
67	17UP1A0566	Garlapati Vedasri	Vedasri	Vedasri	Vedasri
68	17UP1A0567	J V Shivani	Shivani	Shivani	Shivani
69	17UP1A0568	Jaidi Shylaja	Shylaja	A	Shylaja
70	17UP1A0569	Jukunti Sukanya	Sukanya	Sukanya	Sukanya
71	17UP1A0570	Kakera Sindhuja	Sindhuja	Sindhuja	Sindhuja
72	17UP1A0571	Kalleda Deepika	Deepika	A	Deepika
73	17UP1A0572	Kompelli Vaishnavi	Vaishnavi	Vaishnavi	Vaishnavi
74	17UP1A0573	Lingala Sharanya	Sharanya	Sharanya	Sharanya
75	17UP1A0574	M Divya Reddy	Divya	Divya	Divya
76	17UP1A0575	M Hema	Hema	Hema	Hema
77	17UP1A0576	M Navya	Navya	Navya	Navya
78	17UP1A0577	Malipatel Saikerthi	Saikerthi	Saikerthi	Saikerthi
79	17UP1A0578	Marepalli Pooja Reddy	Pooja	Pooja	Pooja



PRINCIPAL  
Vignana Institute of Management & Technology For Women  
Kondapur (V), Ghatkesar (M), Medchal-Malkajgiri (R)-501301  
Telangana State



80	17UP1A0579	Miryala Jyosna	Jyosna	Jyosna	Jyosna
81	17UP1A0580	Munikuntla Mokshaja	Mokshaja	Mokshaja	Mokshaja
82	17UP1A0581	N P Ahalya Mangathayaru	Ahalya	Ahalya	Ahalya
83	17UP1A0582	Nandhini	Nandhini	Nandhini	Nandhini
84	17UP1A0583	P. Maansi Reddy	Maansi	Maansi	Maansi
85	17UP1A0584	Paruchuri Harika	Harika	A	Harika
86	17UP1A0585	Pasupuleti Durgabhavani	Bhavani	Bhavani	Bhavani
87	17UP1A0586	Pendota Harshini	Harshini	Harshini	Harshini
88	17UP1A0587	Pera Padma Sri	Padma	Padma	Padma
89	17UP1A0588	Pochaboina Prasanna	Prasanna	Prasanna	Prasanna
90	17UP1A0589	Poosa Tejashwini	Tejashwini	Tejashwini	Tejashwini
91	17UP1A0590	Ramasahayam Sreethika	Sreethika	Sreethika	Sreethika
92	17UP1A0591	Tantanapally Madhuri	Madhuri	Madhuri	Madhuri
93	17UP1A0592	Tirumalasetti Jahnvi Sai	Jahnvi	Jahnvi	Jahnvi



*Ushay Kumar*  
CO-ORDINATOR

*Vignani*  
PRINCIPAL  
Vignani's Institute of Management & Technology For Women  
Kondapur (V), Ghatkesar (M), Medchal-Malkajgiri (D)-501301  
Telangana State



# VIGNAN'S INSTITUTE OF MANAGEMENT AND TECHNOLOGY FOR WOMEN

(Sponsored by Lavu Educational Society)

Approved by AICTE, New Delhi & Affiliated to JNTUH, Hyderabad.

Kondapur (V), Ghatkesar (M), Medchal - Malkajgiri (D) - 501 301

Accredited By



CSE & ECE

In association with:



## CERTIFICATE OF PARTICIPATION

This certificate is presented to Ms. ...*K. ISHWARYA*.....  
for her participation in a workshop on "Oracle Database Administrator" held  
from **21st - 23rd April, 2022**, Organized by the Department of Computer Science  
and Engineering, in association with Ambest Technovation Pvt. Ltd., Hyderabad.

*Uthay Kumar*  
Co-Ordinator



*[Signature]*  
HoD, CSE

*[Signature]*  
PRINCIPAL  
Vignans Institute of Management & Technology For Women  
Kondapur (V), Ghatkesar (M), Medchal-Malkajgiri (DI)-501301  
Telangana State  
Principal  
PRINCIPAL

Vignans Institute of Management & Technology For Women  
Kondapur (V), Ghatkesar (M), Medchal-Malkajgiri (DI)-501301



Date: 20.10.2021

To  
The Branch Manager,  
Path Creators, Sri Vaikunta Technologies Pvt. Ltd  
New Mark House, Patrika Nagar,  
Hi Tech City,  
Hyderabad- 500081.

**Sub: Request for your kind permission to undergo internship - Reg.**

Dear Sir,

It gives me pleasure to share that, Vignani's Institute of Management and Technology for Women, Hyderabad affiliated to JNTUH University established in year 2008. It is believed that the hands-on approach and experience in the various aspects of industry to enrich their knowledge of the students. In this context, the 4th year students are permitted to go companies to undergo internship which is also part of their curriculum. It is learnt that Sri Vaikunta Technologies Pvt. Ltd is offering Internships to Engineering students in the area of Full Stack Web Development. In this context, request you to permit our students to do internship in the Sri Vaikunta Technologies Pvt. Ltd (Path Creators).

The list of students is

S.No	Roll No	Name of the Student
1	18UP1A0578	Korrapati Mrudhula
2	18UP1A0589	Narikonda Bhanusree
3	18C21A0561	Putta Prathyusha
4	18UP1A0525	Miriyala Reshika
5	18UP1A0538	Neeharika Patel
6	18UP1A0558	Indela Dharani
7	18UP1A05A4	Shaista Sameen

Received  
A.S.

Your consent is solicited at the earliest.

Thanking you Sir,



Kondapur Village: Ghatekesar Mandal, Medchal - Malkajgiri District - 501 301  
Phone : +91 96529 10002/3, E-mail : info.vmtw@gmail.com, hyd.vmtw.principal@gmail.com  
Website : www.vmtw.in

*A.S.*  
HOD-CSE  
Head of the Department  
Computer Science and Engineering  
Vignani's Institute of Management and Technology for Women  
Kondapur (V), Ghatekesar (M), Medchal - Malkajgiri (D) - 501301  
Telangana State

PRINCIPAL  
Vignani's Institute of Management & Technology For Women  
Kondapur (V), Ghatekesar (M), Medchal-Malkajgiri (D)-501301  
Telangana State



Date: 25.10.2021

**INTERNSHIP OFFER LETTER**

To  
 The Head of the Department,  
 Computer Science and Engineering,  
 Vignan's Institute of Management and Technology for women,  
 Hyderabad.

Respected Sir,

We are pleased to offer you an internship opportunity at Sri Vaikunta Technologies Pvt. Ltd, Hyderabad for IV year student's Internship Training Program on Full Stack Web Development. Your internship shall commence on 1<sup>st</sup> November 2021 and shall continue up to 30<sup>th</sup> November 2020. Herewith we accept following students to undergo training and the performance is evaluated and each student is certified. The students have to fulfill the regulations set by the organization.

Roll No	Name of the Student
18UP1A0578	Korrapati Mrudhula
18UP1A0525	Miriyala Reshika
18UP1A0538	Neeharika Patel
18UP1A0558	Indela Dharani
18UP1A05A4	Shaista Sameen

Thanking you

Yours Faithfully,



*ASH*  
 PRINCIPAL



Vignan's Institute of Management & Technology For Women



Date: 10.12.2021

**TO WHOM IT MAY CONCERN**

To  
Korrapati Mrudhula,  
Vignans Institute of Management and Technology for women.

This certification proves that **Korrapati Mrudhula** has completed the internship program at Sri Vaikunta Technologies Pvt. Ltd on Full Stack Web Development started joining the program from 01<sup>st</sup> November, 2021 until 30<sup>th</sup> November, 2021.

During his/her stay in the company as an Intern, he/she displays enthusiasm, leadership, and self-disciplin.

We would like to wish her all the best.

Yours faithfully,

  
  
Technical Manager  
Sri Vaikunta Technologies Pvt. Ltd,  
Path Creators.



  
PRINCIPAL  
Vignans Institute of Management & Technology For Women  
Kondapur (V), Ghatkesar (M), Medchal-Malkajgiri (DK)-501301  
Telangana State



Date: 10.12.2021

**TO WHOM IT MAY CONCERN**

To  
Neeharika Patel  
Vignan's Institute of Management and Technology for women

This certification proves that **Neeharika Patel** has completed the internship program at Sri Vaikunta Technologies Pvt. Ltd on Full Stack Web Development started joining the program from 01<sup>st</sup> November, 2021 until 30<sup>th</sup> November, 2021.

During his/her stay in the company as an Intern, he/she displays enthusiasm, leadership, and self-discipline.

We would like to wish her all the best.

Yours Faithfully

  
Technical Manager  
Sri Vaikunta Technologies Pvt. Ltd,  
Path Creators.



  
PRINCIPAL



Date: 10.12.2021

**TO WHOM IT MAY CONCERN**

To  
Indela Dharani  
Vignan's Institute of Management and Technology for women

This certification proves that **Indela Dharani** has completed the internship program at Sri Vaikunta Technologies Pvt. Ltd on Full Stack Web Development started joining the program from 01<sup>st</sup> November, 2021 until 30<sup>th</sup> November, 2021.

During his/her stay in the company as an Intern, he/she displays enthusiasm, leadership, and self-discipline.

We would like to wish her all the best.

Yours Faithfully

  
Technical Director  
Sri Vaikunta Technologies Pvt. Ltd,  
Path Creators





PRINCIPAL

Vignan's Institute of Management & Technology For Women  
Kondapur (V), Ghatkesar (M), Modchal-Malkajiri (DI)-501301  
Telangana State



Date: 10.12.2021

**TO WHOM IT MAY CONCERN**

To  
Shaista Sameen  
Vignans Institute of Management and Technology for women

This certification proves that **Shaista Sameen** has completed the internship program at Sri Vaikunta Technologies Pvt. Ltd on Full Stack Web Development started joining the program from 01<sup>st</sup> November, 2021 until 30<sup>th</sup> November, 2021.

During his/her stay in the company as an Intern, he/she displays enthusiasm, leadership, and self-discipline.

We would like to wish her all the best.

Yours Faithfully

  
Technical Manager  
Sri Vaikunta Technologies Pvt. Ltd,  
Path Creators.



  
PRINCIPAL

Vignans Institute of Management & Technology For Women  
Kondapur (V), Ghatkesar (M), Medchal-Malkajgiri (Dt)-Suryapet  
Telangana State





Date: 10.12.2021

**TO WHOM IT MAY CONCERN**

To

Miriyala Reshika

Vignan's Institute of Management and Technology for women

This certification proves that **Miriyala Reshika** has completed the internship program at Sri Vaikunta Technologies Pvt. Ltd on Full Stack Web Development started joining the program from 01<sup>st</sup> November, 2021 until 30<sup>th</sup> November, 2021.

During his/her stay in the company as an Intern, he/she displays enthusiasm, leadership, and self-discipline.

We would like to wish her all the best.

Yours Faithfully

  
Technical Manager  
Sri Vaikunta Technologies Pvt. Ltd,  
Path Creators



  
PRINCIPAL

Vignan's Institute of Management & Technology For Women  
Kondapur (V), Ghatkesar (M), Medchal-Malkajgiri (DI)-501301  
Telangana State



# VIGNAN'S INSTITUTE OF MANAGEMENT AND TECHNOLOGY FOR WOMEN

Sponsored by Law Educational Society, Approved by AICTE, New Delhi & Affiliated to JNTUH, Hyderabad.  
Kondapur (V), Ghatkesar (M), Medchal - Malkajgiri (D) - 501 301 Phone: +91 96529 10002/3



VMTW/ PRI /CIR/2021-22 / 17

Date: 11-02-2022

## CIRCULAR

HODs and Placement Coordinators are requested to inform III B.Tech students that "Campus Recruitment Training by COIGN" Phase-2 will be conducted in our college starting from 15-02-2022 to 20-02-2022.

Contact T&P Cell for further information.

Copy To:

1. CEO for information,
2. All the Deans,
3. The HOD (CSE / ECE / EEE / IT / AIML / BSH),
4. IQAC,
5. Admin Office,
6. All Notice Boards,
7. Circulate to all Class Rooms,
8. File.



  
PRINCIPAL  
PRINCIPAL  
Vignans Institute of Management & Technology For Women  
Kondapur (V), Ghatkesar (M), Medchal-Malkajgiri (Dt.)-501301  
Telangana State

  
PRINCIPAL  
Vignans Institute of Management & Technology For Women  
Kondapur (V), Ghatkesar (M), Medchal-Malkajgiri (Dt.)-501301  
Telangana State



## "Campus Recruitment Training by COIGN"

### Schedule of the Program

Sessions (Total: 120 hours)	Topics
Quantitative Aptitude Number of Hours: 08	<ul style="list-style-type: none"> <li>• Simple Equations</li> <li>• Number System</li> <li>• Averages, Allegations and Mixtures</li> <li>• Ratios &amp; Proportions</li> <li>• Percentages, Profit &amp; Loss</li> <li>• SI &amp; CI</li> <li>• Time &amp; Work, Time &amp; Distance</li> </ul>
Verbal Ability Number of Hours: 12	Functional Grammar <ul style="list-style-type: none"> <li>• Basics of Grammar</li> <li>• Sentence Construction</li> <li>• Subject Verb agreement</li> <li>• Tenses, Articles and Prepositions</li> <li>• Idioms &amp; Phrases</li> <li>• Change of Voice and Speech</li> <li>• Sentence Correction</li> </ul> Vocabulary <ul style="list-style-type: none"> <li>• Synonyms, Antonyms</li> <li>• Words Conceptual Utilization</li> </ul>
Logical Reasoning Number of Hours: 10	Logical Reasoning <ul style="list-style-type: none"> <li>• Series &amp; Sequence</li> <li>• Coding Decoding</li> <li>• Directions</li> <li>• Blood relations</li> <li>• Seating Arrangements</li> <li>• Clocks, Calendars</li> <li>• Cubes</li> </ul>
C VS Python Number of Hours: 12	<ul style="list-style-type: none"> <li>• Introduction To C</li> <li>• Bit Manipulation, Number Systems</li> <li>• Patterns, Arrays, Matrices</li> <li>• Functions, Recursion, Pointers</li> <li>• Structures</li> </ul>
Python Programming Number of Hours: 48	<ul style="list-style-type: none"> <li>• Fundamentals of Python Programming</li> <li>• Object Oriented Programming with Python</li> </ul>
Data Structures using Python Number of Hours: 30	<ul style="list-style-type: none"> <li>• Linked Lists</li> <li>• Stacks &amp; Queues</li> <li>• Graphs &amp; Trees</li> <li>• Hashing</li> <li>• Searching &amp; Sorting</li> </ul>



*Handwritten signature*  
**PRINCIPAL**  
 Vignans Institute of Management & Technology For Women  
 Kondapur(V), Ghatkesar(M), Medchal-Malkajgiri(D)-501301  
 Telangana State



**Training & Placement Cell**

**Report on CRT Program Conducted by COIGN**

**Name of the Program:** Campus Recruitment Training

**Name of the Organization:** COIGN

**Dates of the program:** 15-02-2022 to 20-02-2022

**Number of students attended:** 135

The Program conducted in different class rooms include Seminar hall.

**Syllabus:** Quantitative Reasoning skills, Verbal Reasoning skills, analyze an Issue task and Analyze an Argument task, Reading Comprehension, Text Completion and Sentence Equivalence, Quantitative Comparison Questions, Multiple-choice Questions and Numeric Entry Questions.

**Objective:** To enhance the aptitude skills of the students in the area of quantitative aptitude by training them in topics such as number system, data arrangements, Vocabulary and simple and compound interest.

**Outcome:** Students were trained in the area of quantitative aptitude\_ reading comprehension, vocabulary, data arrangements and blood relations, time and work, sentence correction and completion, making them ready for placements.

The undersigned thanked the respective department coordinators and COIGN, for their able support in completing the program successfully.



**Date:** 22-02-2021



**Training & Placement Officer**

Training & Placement Officer  
Vignans Institute of Management  
and Technology for Women  
Kondapur (V), Ghatkesar (M),  
Medchal-Malkajgiri Dist-501301

*[Handwritten Signature]*  
**PRINCIPAL**

**Vignans Institute of Management & Technology For Women**  
Kondapur(V),Ghatkesar(M),Medchal-Malkajgiri(D)-501301  
Telangana State



# VIGNAN'S INSTITUTE OF MANAGEMENT AND TECHNOLOGY FOR WOMEN

Sponsored by Law Educational Society, Approved by AICTE, New Delhi & Affiliated to JNTUH, Hyderabad.  
Kondapur (V), Ghatkesar (M), Medchal - Malkajgiri (D) - 501 301 Phone: +91 96529 10002/3



## Training & Placement Cell CRT Program Conducted by COIGN

### Attendance Sheet

S. No	Hall Ticket No	Student Name	15/02	16/02	17/02	18/02	19/02	20/02
1	19UPIA0401	Arkala Sneha Reddy	P	Ab	P	P	P	P
2	19UPIA0402	Bandi Rasagna	P	P	P	P	Ab	Ab
3	19UPIA0403	Baswa Vignatha	P	P	P	P	P	P
4	19UPIA0404	Belli Pavani	P	P	Ab	P	P	P
5	19UPIA0405	B V Shiva Keerthika	Ab	P	P	P	P	Ab
6	19UPIA0406	D. Sai Lakshmi Sravya	Ab	P	P	Ab	P	P
7	19UPIA0407	Gajula Abhigna	P	Ab	P	Ab	Ab	P
8	19UPIA0408	Gaddam Likhitha	P	P	P	P	P	P
9	19UPIA0409	G. Sai Deepthi	P	P	Ab	P	P	Ab
10	19UPIA0410	Golla Priyanka	P	P	P	P	P	P
11	19UPIA0411	Gourishetti Swetha	P	P	P	P	P	P
12	19UPIA0412	Koppela Nishitha	Ab	P	P	P	Ab	P
13	19UPIA0413	Kalava Charitha	P	P	P	P	P	P
14	19UPIA0414	Kalva Mahathee	P	Ab	P	Ab	P	Ab
15	19UPIA0415	Kande Lahari	P	P	Ab	P	P	P
16	19UPIA0416	Kandula Meghana	P	P	P	P	P	P
17	19UPIA0417	K.Tejaswini	P	Ab	P	P	P	P
18	19UPIA0418	Kunchetti Pravalika	Ab	Ab	P	Ab	Ab	P
19	19UPIA0419	L.Abhinaya	Ab	P	P	P	P	Ab
20	19UPIA0420	Manne Sravani	P	P	P	P	P	P
21	19UPIA0421	Nakka Lavanya	P	P	P	P	P	P
22	19UPIA0422	N.Priya	P	P	Ab	P	P	P
23	19UPIA0423	Pushadapu Lavanya	P	P	P	Ab	P	P
24	19UPIA0424	Palle Pavani	P	P	P	P	P	Ab
25	19UPIA0425	P.Prasanna Laxmi	Ab	P	P	P	Ab	P
26	19UPIA0426	P Sindhu	P	P	P	P	P	P
27	19UPIA0427	R. Maheshwari Singh	Ab	Ab	Ab	Ab	P	P
28	19UPIA0428	Rowthu Pallavi	P	P	P	P	P	P
29	19UPIA0429	Syed Tabassam	P	P	P	P	P	Ab
30	19UPIA0430	S. Jayasree Bhavani	P	P	P	P	P	P
31	19UPIA0431	Sangoju Sathwika	Ab	P	P	P	Ab	P
32	19UPIA0432	S.Amitha	P	P	P	Ab	P	P
33	19UPIA0433	Sivva Akshaya	P	Ab	P	P	P	P
34	19UPIA0434	S.Lakshmi Yesaswini	Ab	P	Ab	P	P	Ab
35	19UPIA0435	Sugguna Lakshita	P	P	P	P	P	P
36	19UPIA0436	Tankala Harika	P	P	P	Ab	Ab	P
37	19UPIA0437	Thoorna Sreya Reddy	P	P	P	P	P	P
38	19UPIA0438	Uppala Shuvaleela	P	P	P	P	P	P
39	19UPIA0439	V. Ashvitha Reddy	P	P	Ab	P	P	Ab
40	19UPIA0440	Vankudoth Sangitha	Ab	P	P	P	P	P
41	19UPIA0441	V. Lakshmi Varunitha	P	Ab	P	P	Ab	P



PRINCIPAL  
Vignans Institute of Management & Technology For Women  
Kondapur(V), Ghatkesar(M), Medchal-Malkajgiri(D)-501301  
Telangana State



# VIGNAN'S INSTITUTE OF MANAGEMENT AND TECHNOLOGY FOR WOMEN



Sponsored by Law Educational Society, Approved by AICTE, New Delhi & Affiliated to JNTUH, Hyderabad.  
Kondapur (V), Ghatkesar (M), Medchal - Malkajgiri (D) - 501 301 Phone: +91 96529 10002/3

42	19UPIA0442	Y. Gayathri Manasa	-Ab	P	-Ab	P	P	-Ab
43	20UP5A0401	A. Prathima Bharathi	P	P	P	P	P	P
44	20UP5A0402	Edugu Rajitha	P	-Ab	P	-Ab	P	P
45	20UP5A0403	Godavarthi Anusha	P	P	P	P	-Ab	P
46	20UP5A0404	Goika Anusha	P	P	P	P	P	P
47	20UP5A0405	Gopi Varsha	-Ab	P	P	P	P	-Ab
48	20UP5A0406	Jupally Navya Sri	P	P	-Ab	P	P	P
49	20UP5A0407	Kola Chethana	P	-Ab	P	-Ab	-Ab	P
50	20UP5A0408	Kotthar Devi	P	P	P	P	Ab	P
51	20UP5A0409	Muppaneni Sowmya	P	P	P	P	P	-Ab
52	19UPIA0443	Arani Pragathi	-Ab	P	-Ab	P	P	P
53	19UPIA0444	Arumoju Kavya	P	P	-Ab	-Ab	P	P
54	19UPIA0446	Banala Smitika	P	P	P	P	P	P
55	19UPIA0447	B. Naga Sai Saranya	P	Ab	P	P	Ab	-Ab
56	19UPIA0448	Bogala Anusha	P	P	P	P	P	P
57	19UPIA0449	Bokka Harshitha	P	P	P	P	P	P
58	19UPIA0450	Bokka Varshitha	-Ab	P	-Ab	-Ab	P	P
59	19UPIA0451	Bollepally Jashanvi	P	P	P	P	P	P
60	19UPIA0452	Chimata Madhavi	P	P	P	P	P	-Ab
61	19UPIA0453	D. Venkata Sahithaya	P	-Ab	P	P	-Ab	P
62	19UPIA0454	Dugyala Vaishnavi	P	P	P	P	Ab	P
63	19UPIA0455	G.Shirisha	P	P	-Ab	-Ab	P	P
64	19UPIA0456	Gubale Nishitha	-Ab	P	-Ab	P	P	P
65	19UPIA0457	G. Harsha Vardhini	P	P	P	P	P	-Ab
66	19UPIA0458	G. Socha Reddy	P	-Ab	P	P	P	P
67	19UPIA0459	Haldoddi Divya	P	P	P	P	-Ab	P
68	19UPIA0460	Janjala Anusha	P	P	P	-Ab	P	P
69	19UPIA0461	Karkuri Sowmya	-Ab	P	-Ab	P	P	P
70	19UPIA0462	Kalyanam Mounika	P	P	P	P	P	-Ab
71	19UPIA0463	Kommineni Jasmita	P	P	P	P	-Ab	P
72	19UPIA0464	Konderu Sravya	P	-Ab	-Ab	P	P	P
73	19UPIA0465	L. Prasanna Laxmi	P	P	P	-Ab	P	P
74	19UPIA0466	Gaddam Likhitha	P	P	P	P	P	P
75	19UPIA0467	Limbare Santhoshi	-Ab	P	-Ab	P	P	-Ab
76	19UPIA0468	M. Yogitha Reddy	P	P	P	P	P	P
77	19UPIA0469	Marvala Deepika	P	-Ab	P	P	-Ab	P
78	19UPIA0470	Meda Bhuvaneshwari	P	P	P	-Ab	P	P
79	19UPIA0471	Padakula Uma	P	P	-Ab	P	P	P
80	19UPIA0472	Ramidi Deekshitha	-Ab	P	P	P	P	-Ab
81	19UPIA0473	Ravula Hirammai	P	P	P	P	P	P
82	19UPIA0474	Shanigala Chandana	P	-Ab	P	P	-Ab	P
83	19UPIA0475	M. Siri Chandana Reddy	P	P	P	-Ab	-Ab	P
84	19UPIA0476	Suroju Srivaishnavi	P	P	-Ab	P	P	P
85	19UPIA0477	T. Sreya Reddy	-Ab	P	P	P	P	-Ab
86	19UPIA0478	Thamatam Akshitha	P	P	P	P	P	P
87	19UPIA0479	Turna Shrivani	P	P	P	-Ab	P	P
88	19UPIA0480	Vadeti Ramy	P.	-Ab.	P.	P	-Ab	P



*[Signature]*

PRINCIPAL

Vignans Institute of Management & Technology For Women  
Kondapur(V), Ghatkesar(M), Medchal-Malkajgiri(D)-501301  
Telangana State



# VIGNAN'S INSTITUTE OF MANAGEMENT AND TECHNOLOGY FOR WOMEN

Sponsored by Laxmi Educational Society, Approved by AICTE, New Delhi & Affiliated to JNTUH, Hyderabad.  
Kondapur (V), Ghatkesar (M), Medchal - Malkajgiri (D) - 501 301 Phone: +91 96529 10002/3



89	19UPIA0481	V. Anoushika	P	P	P	P	P	P
90	19UPIA0482	Yedulia Nagalaxmi	Ab	P	P	Ab	P	P
91	20UP5A0410	Nagaram Anusha	P	P	Ab	P	P	P
92	20UP5A0411	Nakka Yamini	P	Ab	P	P	P	Ab
93	20UP5A0412	Nattuva Bhargavi	P	P	P	P	Ab	P
94	20UP5A0413	Palasa Chandana	Ab	P	P	P	P	P
95	20UP5A0414	Sankuri Sravani	P	P	Ab	Ab	P	P
96	20UP5A0415	T Anusha	P	P	P	P	P	P
97	20UP5A0416	Vaddaboina Namratha	P	Ab	P	P	P	P
98	20UP5A0417	Vadla Shivani	P	P	P	P	Ab	Ab
99	20UP5A0418	Vindhya Darshini	P	P	P	P	P	P
100	20UP5A0419	Yanjala Sharnili	Ab	P	Ab	P	P	P
101	16UPIA05A9	Vuppala Keerthi Reddy	P	P	P	Ab	P	P
102	18UPIA0542	Rapolu Chandana	P	Ab	P	P	Ab	Ab
103	19UPIA0501	Alladi Ashwitha	P	P	P	P	P	P
104	19UPIA0502	Allakattu Pranusha	P	P	Ab	P	P	P
105	19UPIA0503	Annula Tejaswi	Ab	P	P	Ab	P	P
106	19UPIA0504	Bejagam Bhavana	P	P	P	P	P	P
107	19UPIA0505	Bhoopathi Deepthi	P	P	P	P	Ab	Ab
108	19UPIA0506	Bogu Vysnavi	P	Ab	P	P	P	P
109	19UPIA0507	Ch. Tejaswini	P	P	P	Ab	P	P
110	19UPIA0508	Chikani Likhitha	Ab	P	Ab	P	P	P
111	19UPIA0509	Ch. Varshini Yadav	P	P	P	P	P	P
112	19UPIA0510	G.Akankasha	P	Ab	P	P	Ab	Ab
113	19UPIA0511	Gaddam Akshitha	P	P	P	P	P	P
114	19UPIA0512	Gaddam Joshitha	P	P	P	P	P	P
115	19UPIA0513	Gardas Nikhitha	Ab	P	Ab	Ab	P	P
116	19UPIA0514	Garre Preethi	P	P	P	P	P	P
117	19UPIA0515	Guddeti Manogna	P	P	P	P	Ab	Ab
118	19UPIA0516	Kandul Nethra	P	Ab	P	P	P	P
119	19UPIA0517	Kankanala Harika	P	P	Ab	Ab	P	P
120	19UPIA0518	Karnampally Niharika	P	P	P	P	P	P
121	19UPIA0519	K. Chandra Lekha	Ab	P	P	P	P	Ab
122	19UPIA0520	K.Shreya Reddy	P	P	P	P	Ab	P
123	19UPIA0521	K. Sowjanya	P	P	P	P	P	P
124	19UPIA0522	Kovuri Radha	P	Ab	P	Ab	P	P
125	19UPIA0523	Kuntigorla Tejaswini	P	P	Ab	P	P	P
126	19UPIA0524	Kyatham Pravalika	P	P	P	P	P	P
127	19UPIA0525	Likhitha Pawar	Ab	P	P	P	Ab	Ab
128	19UPIA0526	M Gouthami	P	P	P	P	P	P
129	19UPIA0527	Maradugu Poojitha	P	P	P	Ab	P	P
130	19UPIA0528	M. Nunsavath	P	Ab	Ab	P	P	P
131	19UPIA0529	M.Sneharshitha	P	P	P	P	P	Ab
132	19UPIA0530	Mylapally Amulya	Ab	P	P	P	Ab	P
133	19UPIA0531	N Soniya	P	P	P	Ab	P	P
134	19UPIA0532	Nakirekanti Sathvika	P	Ab	P	P	P	P
135	19UPIA0533	N...	P	P	Ab	P	P	Ab



**PRINCIPAL**

Vignan's Institute of Management & Technology For Women  
Kondapur(V), Ghatkesar(M), Medchal-Malkajgiri(D)-501301  
Telangana State



# VIGNAN'S INSTITUTE OF MANAGEMENT AND TECHNOLOGY FOR WOMEN

Sponsored by Laxmi Educational Society, Approved by AICTE, New Delhi & Affiliated to JNTUH, Hyderabad.  
Kondapur (V), Ghatkesar (M), Medchal - Malkajgiri (D) - 501 301 Phone: +91 96529 10002/3



VMTW/TP/CIR/2020-21/08

Date: 02-04-2021

## CIRCULAR

All the HODs and Placement Coordinators are here by requested to inform III B.Tech students that **"Campus Recruitment Training by Six Phrase"** will be conducted in our college starting from 05-04-2021 to 09-04-2021.

Contact T&P Cell for further information

  
PRINCIPAL

Copy to:

1. CEO for information,
2. All the Deans,
3. The HOD (CSE/ IT / ECE / EEE, BSH),
4. IQAC,
5. Admin Office,
6. All Notice Boards,
7. Circulate to all Class Rooms,
8. File

  
PRINCIPAL

Vignans Institute of Management & Technology For Women  
Kondapur (V), Ghatkesar (M), Medchal-Malkajgiri (Dt.)-501301  
Telangana State







# VIGNAN'S INSTITUTE OF MANAGEMENT AND TECHNOLOGY FOR WOMEN

Sponsored by Lavu Educational Society, Approved by AICTE, New Delhi & Affiliated to JNTUH, Hyderabad.  
Kondapur (V), Ghalkesar (M), Medchal - Makajiri (D) - 501 301 Phone: +91 96529 10002/3



## Training & Placement Cell

### Report on CRT Program Conducted by Six Phrase

**Name of the Programme:** Campus Recruitment Training

**Syllabus:** Verbal aptitude, Reading comprehension, computer fundamentals Quantitative aptitude, group discussion, interview skills, number system, logical reasoning, coding and decoding, resume writing and email and telephone etiquette.

**Objective:** To train the students in areas such as quantitative aptitude, verbal aptitude, reading comprehension, fundamentals of programming and soft skills to make them ready for placements.

**Name of the Organization:** Six Phrase

**Name of the instructor:** J. Praveen

**Dates of the program:** 05-04-2021 to 09-04-2021

**Number of students attended:** 114

**Outcome:** Students were trained in quantitative aptitude, logical reasoning, verbal aptitude, reading comprehension, soft skills, group discussions, interview skills. Resume writing, and email and telephone etiquette, making them ready for campus placements.

The undersigned thanked the respective department coordinators and Six Phrase, for their able support in completing the program successfully.



Date: 12-03-2020

Training & Placement officer



*J. Praveen*  
PRINCIPAL  
Vignans Institute of Management & Technology for Women  
Kondapur (V), Ghalkesar (M), Medchal - Makajiri (D) - 501301  
Telangana State

*[Signature]*  
Training & Placement Officer  
Vignans Institute of Management  
Kondapur (V), Ghalkesar (M),  
Medchal - Makajiri (D) - 501301  
Telangana State



# VIGNAN'S INSTITUTE OF MANAGEMENT AND TECHNOLOGY FOR WOMEN

Sponsored by Law Education Society, Approved by AICTE, New Delhi & Affiliated to JNTUH, Hyderabad.  
Kondapur (V), Ghatkesar (M), Medchal - Malkajgiri (D) - 501 301 Phone: +91 96529 10002/3



## Training & Placement Cell

### CRT Program Conducted by Six Phrase

CSE attendance Sheet

Date: 05-04-2021 to 09-04-2021

SN	Roll No	Name	05/04	06/04	07/04	08/04	09/04
1	18UP1A0501	Anreddy Pooja Sree	P	P	P	P	Ab
2	18UP1A0502	Are Sadhana	P	P	P	Ab	P
3	18UP1A0503	Avula Kavya Sri	Ab	P	P	P	P
4	18UP1A0504	Balne Unvitha	P	P	P	P	P
5	18UP1A0505	Bandaru Pranathi	P	P	Ab	Ab	P
6	18UP1A0506	Bellamkonda Vyshnavi	P	Ab	P	P	P
7	18UP1A0507	Ch. Mahima Chandra	Ab	P	P	P	Ab
8	18UP1A0508	Dasari Ruchitha	P	P	P	P	P
9	18UP1A0509	Deekonda Raaga Priya	P	P	P	Ab	P
10	18UP1A0510	Devandla Swapna	P	P	P	P	P
11	18UP1A0511	Devishetti Ashritha	P	Ab	Ab	P	P
12	18UP1A0512	Eliiti Nandini	P	P	P	P	Ab
13	18UP1A0513	Gujja Harshitha Reddy	Ab	P	P	P	P
14	18UP1A0514	Gajula Vidya	P	P	P	Ab	P
15	18UP1A0515	Guntur Komali	Ab	Ab	P	P	P
16	18UP1A0516	Jeeyar Prasanna	P	P	P	P	Ab
17	18UP1A0517	K Rishika	P	P	P	P	P
18	18UP1A0518	K. Keerthi Reddy	P	P	Ab	P	P
19	18UP1A0519	Kandakatla Navya	Ab	P	P	P	P
20	18UP1A0520	Kappari Sowmya	P	P	P	Ab	P
21	18UP1A0521	Karla Keerthana	P	P	P	P	Ab
22	18UP1A0522	Koppu Alekhya	P	Ab	Ab	P	P
23	18UP1A0523	Kotha Sravani	Ab	P	P	P	P
24	18UP1A0524	M.Sravani	P	P	P	P	P
25	18UP1A0525	Miriyala Reshika	P	P	Ab	Ab	P
26	18UP1A0526	Molugu Manasa	P	Ab	P	P	P
27	18UP1A0527	Mukka Mahima	P	P	P	P	Ab
28	18UP1A0528	M. Y. Naga Lakshmi	Ab	P	P	P	P
29	18UP1A0529	Muppalla Sai Sree	P	P	Ab	Ab	P
30	18UP1A0530	Nangunuri Akhila	P	P	P	P	P
31	18UP1A0531	Neelam Vineela	Ab	Ab	P	P	P
32	18UP1A0532	Neeluri Rishita	P	P	P	Ab	P
33	18UP1A0533	Palvai Nikhitha	P	P	P	P	P
34	18UP1A0534	Panjala Chandana	P	Ab	P	Ab	Ab
35	18UP1A0535	Parsi Varsha	P	P	Ab.	P	P



*[Signature]*  
PRINCIPAL

Vignans Institute of Management & Technology For Women  
Kondapur(V), Ghatkesar(M), Medchal-Malkajgiri(D)-501301  
Telangana State



# VIGNAN'S INSTITUTE OF MANAGEMENT AND TECHNOLOGY FOR WOMEN



Sponsored by Lawu Educational Society, Approved by AICTE, New Delhi & Affiliated to JNTUH, Hyderabad.  
Kondapur (V), Ghatkesar (M), Medchal - Malkajgiri (D) - 501 301 Phone: +91 96529 10002/3

36	18UP1A0536	Pasham Shravani	Ab	P	P	Ab	P
37	18UP1A0537	Pasunuti Sindhu	P	Ab	P	P	P
38	18UP1A0538	Neeharika Patel	P	P	P	P	P
39	18UP1A0539	P. Ikyatha	P	P	P	Ab	P
40	18UP1A0540	Raju Bindu	P	P	P	P	P
41	18UP1A0541	Raparathi Sathvika	Ab	Ab	P	Ab	P
42	18UP1A0542	Rapolu Chandana	P	P	P	P	Ab
43	18UP1A0543	S Meghana	P	P	P	P	Ab
44	18UP1A0544	Sai Mounika Viyyapu	P	Ab	P	P	P
45	18UP1A0545	Sanka Ramasai	P	P	Ab	P	P
46	18UP1A0546	Singaram Priyanshi	P	P	Ab	Ab	P
47	18UP1A0547	Suryadevara Maneesha	P	P	P	P	P
48	18UP1A0548	Telukutla Priyanka	Ab	P	P	P	Ab
49	18UP1A0549	Talapalli Sahithi	P	P	P	P	P
50	18UP1A0550	Nikhitha Thumula	P	Ab	P	Ab	P
51	18UP1A0551	V.Sravanapragathi	P	P	P	P	P
52	18UP1A0552	V Shravya	P	P	P	P	Ab
53	18UP1A0553	Vemula Sai Esha	P	P	P	P	P
54	18UP1A0554	Volloju Jagadeshwari	Ab	P	Ab	P	P
55	18UP1A0555	Vunnam Sushmithasiri	P	Ab	P	P	P
56	18UP1A0556	Voruganti Rochishna	P	P	P	Ab	P
57	18UP1A0557	M. Eswari Sai Sarayu	P	P	P	P	Ab
58	18UP1A0558	Indela Dharani	P	Ab	P	P	P
59	18UP1A0559	Achalla Yagnamukhi	P	P	P	Ab	P
60	18UP1A0560	Alapati Harshini	P	P	P	P	P
61	18UP1A0561	Ankam Jaswitha	P	P	P	Ab	P
62	18UP1A0562	A. Bhagya Chandana	P	P	P	P	Ab
63	18UP1A0563	Bathina Harshitha	P	Ab	Ab	P	Ab
64	18UP1A0564	B. Lakshmi Manasa	Ab	P	P	P	P
65	18UP1A0565	Bojja Priyanka	Ab	P	P	P	P
66	18UP1A0566	Bramanapally Supriya	P	P	P	Ab	P
67	18UP1A0567	Cheeli Swetha	P	P	P	Ab	P
68	18UP1A0568	Chilam Anuradha	P	P	P	Ab	P
69	18UP1A0569	Chirala Ramya	P	Ab	P	Ab	P
70	18UP1A0570	Damsani Srija	P	P	P	P	P
71	18UP1A0571	Gunda Abhi Sri	P	P	P	P	P
72	18UP1A0572	G. Hema Latha	Ab	P	Ab	P	Ab
73	18UP1A0573	Gollapudi Likhita	P	P	Ab	P	P
74	18UP1A0574	G.Lathika Chowdary	P	P	P	P	P
75	18UP1A0575	J Lalitha Priya	P	Ab	Ab	P	P
76	18UP1A0576	Jillapa...	Ab	P	P	P	P



*[Signature]*

PRINCIPAL

Vignana's Institute of Management & Technology For Women  
Kondapur(V), Ghatkesar(M), Medchal-Malkajgiri(D)-501301  
Telangana State



# VIGNAN'S INSTITUTE OF MANAGEMENT AND TECHNOLOGY FOR WOMEN

Sponsored by Laxmi Educational Society, Approved by AICTE, New Delhi & Affiliated to JNTUH, Hyderabad.  
Kondapur (V), Ghatkesar (M), Medchal - Malkajgiri (D) - 501 301 Phone: +91 96529 10002/3



77	18UP1A0577	Kallutla Jaya Sindhuri	P	P	P	P	-Ab
78	18UP1A0578	Korrapati Mrudhula	P	-Ab	P	-Ab	P
79	18UP1A0579	Kota Vasavi Vineetha	P	P	P	P	-Ab
80	18UP1A0580	Kotha Srinidhi	-Ab	P	P	P	-Ab
81	18UP1A0581	Manepalli Pooja Sai Sree	P	P	P	-Ab	P
82	18UP1A0582	Machan Anuksha	P	P	P	P	-Ab
83	18UP1A0583	Madishetty Manasa	P	P	-Ab	P	P
84	18UP1A0584	Matroju Shravya	P	P	-Ab	P	P
85	18UP1A0585	M. Sharanya Reddy	-Ab	P	P	-Ab	P
86	18UP1A0586	M. Harshitha Mahesh	P	P	P	P	P
87	18UP1A0587	Miryala Pooja	P	P	-Ab	P	P
88	18UP1A0588	N Naga Deepthi	P	-Ab	P	P	P
89	18UP1A0589	Narikonda Bhanusree	P	P	P	-Ab	P
90	18UP1A0590	Neela Akhila	-Ab	P	P	P	-Ab
91	18UP1A0591	Neelapala Monika	P	P	-Ab	P	P
92	18UP1A0592	Neeradi Pravalika	P	-Ab	P	P	P
93	18UP1A0593	P Hemalatha	P	P	P	P	-Ab
94	18UP1A0594	Vamika Patangay	-Ab	P	P	P	P
95	18UP1A0595	Raavi Harshitha	P	P	P	-Ab	P
96	18UP1A0596	Rakkireddy Vinitha	P	P	P	P	-Ab
97	18UP1A0597	Rangu Sushma	P	-Ab	P	P	P
98	18UP1A0598	Renikindi Ridhima	P	P	-Ab	P	P
99	18UP1A0599	Sainikhitha	-Ab	P	P	P	-Ab
100	18UP1A05A0	Sakkirolla Sriraaga	P	P	P	P	P
101	18UP1A05A1	Samala Akshitha	P	P	P	P	-Ab
102	18UP1A05A2	Sangeetha	P	P	P	-Ab	P
103	18UP1A05A3	Savalam Bhavani	P	P	P	-Ab	P
104	18UP1A05A4	Shaista Sameen	P	P	-Ab	P	P
105	18UP1A05A5	Siliveri Rasagnya	-Ab	P	P	P	P
106	18UP1A05A6	S. Sai Niharika	-Ab	P	P	P	-Ab
107	18UP1A05A7	Sri Vani Madhav	P	P	-Ab	P	P
108	18UP1A05A8	Tadisetti Sravya	P	-Ab	P	P	P
109	18UP1A05A9	Thandar Palli Swathi	P	P	P	-Ab	P
110	18UP1A05B0	Uppuluri Bharathi	P	P	P	P	-Ab
111	18UP1A05B1	Vemula Pavani	-Ab	P	P	P	P
112	18UP1A05B2	Vinjamuri Navya	-Ab	P	P	P	P
113	18UP1A05B3	Y. S. Venkata Naga Sriya	-Ab	P	P	-Ab	P
114	18UP1A05B4	Yerukala Nuthana	P	P	-Ab	P	P



*[Signature]*  
PRINCIPAL

Vignans Institute of Management & Technology For Women  
Kondapur (V), Ghatkesar (M), Medchal - Malkajgiri (D) - 501 301  
Telangana



# VIGNAN'S INSTITUTE OF MANAGEMENT AND TECHNOLOGY FOR WOMEN

Sponsored by Laxmi Educational Society, Approved by AICTE, New Delhi & Affiliated to JNTUH, Hyderabad.  
Kondapur (V), Ghatkesar (M), Medchal - Malkajgiri (D) - 501 301 Phone: +91 96529 10002/3



VMTW/CSE/CIR/2021-22/II /04

Date:20/03/2021

## CIRCULAR

This is to inform all the students of B.Tech III year that there will be "A Seminar on JSON" on 24/03/2021 by **Mr.PrabhakaranGaneshan, Co-Founder, KodNest Technologies,** Bangalore . The Seminar will be coordinated by Mr.S.DilliBabu. All the students are here to attend the Seminar and make it a successful one.

Copy to:

1. CEO for information,
2. All the Deans,
3. The HOD (CSE / ECE / EEE / IT / AIML / BSH),
4. IQAC,
5. Admin Office,
6. All Notice Boards,
7. Circulate to all Class Rooms,
8. File.

  
PRINCIPAL  
PRINCIPAL

vignani's Institute of Management & Technology For Women  
Kondapur (V), Ghatkesar (M), Medchal-Malkajgiri (D)-501301  
Telangana State



  
PRINCIPAL  
vignani's Institute of Management & Technology For Women  
Kondapur (V), Ghatkesar (M), Medchal-Malkajgiri (D)-501301  
Telangana State



# VIGNAN'S INSTITUTE OF MANAGEMENT AND TECHNOLOGY FOR WOMEN

(Sponsored by Lavu Educational Society)  
Approved by AICTE, New Delhi & Affiliated to JNTUH, Hyderabad.  
Kondapur (V), Ghatkesar (M), Medchal - Malkajgiri (D) - 501 301



## DEPARTMENT OF COMPUTER SCIENCE AND ENGINEERING

# A SEMINAR ON JSON

24<sup>TH</sup> MARCH, 2021 @ SEMINAR HALL



Resource Person:  
**Mr. G. Prabhakaran**  
Co-Founder,  
KodNest Technologies



Chief Patron:  
**Dr. Lavu Rathalah,**  
Chairman, Vignan Group.

Patron:  
**Mr. B. Shravan,**  
CEO, Vignan Group.

Co-Patron:  
**Dr. G. Apparao Naidu,**  
Principal, VMTW.

Advisor:  
**Dr. A. Sudhir Babu,**  
Associate Professor & HOD,  
Dept. of CSE.

Co-Ordinator:  
**Mr. S. Dilli Babu,**  
Assistant Professor,  
Dept. of CSE,  
Cell: +91 88011 79588



  
PRINCIPAL

Vignan's Institute of Management & Technology For Women  
Kondapur (V), Ghatkesar (M), Medchal - Malkajgiri (D) - 501 301  
Telangana State



# VIGNAN'S INSTITUTE OF MANAGEMENT AND TECHNOLOGY FOR WOMEN

Sponsored by Law Educational Society, Approved by AICTE, New Delhi & Affiliated to JNTUH, Hyderabad.  
Kondapur (V), Ghatkesar (M), Medchal - Malkajiri (D) - 501 301 Phone: +91 96529 10002/3



## DEPARTMENT OF COMPUTER SCIENCE AND ENGINEERING

### Seminar report on "JSON"

Name of the Programme: Seminar on JSON  
Organized by: Department of CSE  
Schedule dates: 24-03-2021.  
Resource Person: Mr.PrabhakaranGaneshan, Co-Founder, KodNest Technologies.



**Objective of the Program:** This Seminar covered the basic algorithm that helps us to build and apply prediction functions with an emphasis on practical applications.

**Outcomes of the Seminar:** Connect to APIs and retrieve JSON data, Parse JSON data from Strings, be able to work with JavaScript Objects, understand how JavaScript Arrays work, Create JSON object arrays.

JSON format is used for serializing and transmitting structured data over network connection. It is primarily used to transmit data between a server and web applications.

  
Coordinator

  
HOD-CSE



  
PRINCIPAL  
Vignan's Institute of Management & Technology For Women  
Kondapur (V), Ghatkesar (M), Medchal-Malkajiri (Dt)-501301  
Telangana State

Name of the Organization: KodNest			
Course Instructor: Mr. Prabhakaran Ganeshan			
S. No	Hall Ticket No	Student Name	sign
1	19UP1A05A3	Ayenala Deekshitha	Deekshitha
2	19UP1A05A4	Badugu Charani	Charani
3	19UP1A05A5	Banda Swetha	Swetha
4	19UP1A05A6	Bodla Sravani	Sravani
5	19UP1A05A7	Boga Vaisnavi	Vaisnavi
6	19UP1A05A8	Byreddy Yashaswi	Yashaswi
7	19UP1A05A9	Shinde Chandrika	Chandrika
8	19UP1A05B0	Chithakuntala Poojitha	Poojitha
9	19UP1A05B1	Dasaraju Sandhya	Sandhya
10	19UP1A05B2	Dende Aakansha	Aakansha
11	19UP1A05B3	Dhanthuri Sai Aishwarya	Sai Aishwarya
12	19UP1A05B4	Enreddy Sai Chaithra	Sai Chaithra
13	19UP1A05B5	Gyara Chandhana	Chandhana
14	19UP1A05B6	Gaddam Akshitha	Akshitha
15	19UP1A05B7	Gantela Supriya	Supriya
16	19UP1A05B8	Goginenti Mugda Shishira	Mugda Shishira
17	19UP1A05B9	Guttumukkala Sai Bhavana	Sai Bhavana
18	19UP1A05C0	G.Shivani Reddy	Shivani Reddy
19	19UP1A05C1	Harika Sirandass	Harika
20	19UP1A05C2	Jonnalagadda Nithesha	Nithesha
21	19UP1A05C3	Katkuri Hema	Hema
22	19UP1A05C4	Kethireddy Sathwika	Sathwika
23	19UP1A05C5	Konkimalla Venkata Dhruvitha	Dhruvitha
24	19UP1A05C6	Koppula Deepika Reddy	Deepika
25	19UP1A05C7	Kukunoor Monikagoud	Monika
26	19UP1A05C8	Kunchetti Pranathi	Pranathi
27	19UP1A05C9	Moola.Manasa	Manasa
28	19UP1A05D0	Madas Pallavi	Pallavi
29	19UP1A05D1	Maliga Manasa	Manasa
30	19UP1A05D2	Marikundam .Hasitha	Hasitha
31	19UP1A05D4	Methari Keeravani	Keeravani
32	19UP1A05D5	Muttineni.Sai Harshitha	Sai Harshitha
33	19UP1A05D6	Mysa Sreevalli	Sreevalli
34	19UP1A05D7	Puli .Sri Sruthi	Sruthi
35	19UP1A05D8	Ramdas Swapna	Swapna
36	19UP1A05D9	Ramelli Vandana	Vandana
37	19UP1A05E0	Rangaraju Keerthana	Keerthana
38	19UP1A05E1	Rapolu Swetha	Swetha
39	19UP1A05E2	Rayudu Aishwarya	Aishwarya
40	19UP1A05E3	Sana Saleem	Sana



PRINCIPAL  
 Vidya's Institute of Management & Technology For Women  
 Kondapur(Y), Ghatkesar(M), Medchal-Malkajgiri(DR)-501301  
 Telangana State



41	19UP1A05E4	Silver Akhila	Akhila
42	19UP1A05E5	Somireddy Srenitha Reddy	Srenitha
43	19UP1A05E6	Sripathi Snigdha Reddy	Snigdha
44	19UP1A05E7	Thallapelly Rashmitha	Rashmitha
45	19UP1A05E8	Thota Tushara Priya	Priya
46	19UP1A05E9	Thotapally Sindhuja	Sindhuja
47	19UP1A05F0	Toguta Kavya	Kavya
48	19UP1A05F1	Uppala Sahithi	Sahithi
49	19UP1A05F2	Vakiti Varsha	Varsha
50	19UP1A05F3	Vanama Santhoshini	Santhoshini
51	20UP5A0501	Mandula Vaibhavi Shine	Vaibhavi
52	20UP5A0502	Nukala Alekhya	Alekhya
53	20UP5A0503	Veeramalla Umadevi	Umadevi
54	20UP5A0504	Yalagandhula Mounika	Mounika



*Radhika*  
**PRINCIPAL**  
 Vignani's Institute of Management & Technology For Women  
 Kondapur(V), Ghatkesar(M), Medchal-Malkajgiri(Dt)-501307  
 Telangana State



VMTW/CSE/CIR/2020-2021/I/05

Date: 09/12/2020

### CIRCULAR

This is to inform all the student of B.Tech IV year that there will be "A Seminar on "Augmented Reality & Virtual Reality" on 14/12/2020 by Dr. Khaleel Ur Rahman Khan, Professor & Dean, Department of CSE , ACE Engineering College, Hyderabad. The Seminar will be coordinated by Dr.S.RangaSwamy. All the students are here to attend the Seminar and make it a successful one.

PRINCIPAL  
PRINCIPAL

Vignani's Institute of Management & Technology For Women  
Kondapur (V), Ghatkesar (M), Medchal-Malkajgiri (D) - 501301  
Telangana State

Copy to:

1. The Principal, for his kind information.
2. All the Deans.
3. The HOD (CSE / ECE / EEE / IT / AIML / BSH)
4. IQAC,
5. Admin Office.
6. All Notice Boards.
7. Circulate to all Class Rooms.
8. File



PRINCIPAL  
Vignani's Institute of Management & Technology For Women  
Kondapur (V), Ghatkesar (M), Medchal-Malkajgiri (D)-501301  
Telangana State



# VIGNAN'S INSTITUTE OF MANAGEMENT AND TECHNOLOGY FOR WOMEN

(Sponsored by Lavu Educational Society)  
Approved by AICTE, New Delhi & Affiliated to JNTUH, Hyderabad.  
Kondapur (V), Ghatkesar (M), Medchal - Malkajgiri (D) - 501 301



DEPARTMENT OF COMPUTER SCIENCE AND ENGINEERING

## ONLINE SEMINAR ON AUGMENTED REALITY AND VIRTUAL REALITY 14<sup>TH</sup> DECEMBER, 2020

Link: <https://meet.google.com/zvo-ettd-zvc>



Resource Person:  
**Dr. Khaleel Ur Rahman Khan,**  
Professor & Dean,  
Department of CSE,  
ACE Engineering College, Hyderabad



In association with:



Chief Patron:  
**Dr. Lavu Rathaiah,**  
Chairman, Vignan Group.

Patron:  
**Mr. B. Shraavan,**  
CEO, Vignan Group.

Co-Patron:  
**Dr. G. Apparao Naidu,**  
Principal, VMTW.

Advisor:  
**Mrs. V. Indrani,**  
Associate Professor & HOD,  
Dept. of CSE.

Co-Ordinator:  
**Dr. S. Rengaswamy,**  
Associate Professor, CSE.  
Cell: +91 96529 10002



  
PRINCIPAL  
Vignan's Institute of Management & Technology For Women  
Kondapur (V), Ghatkesar (M), Medchal-Malkajgiri (D)-501301  
Telangana State



**DEPARTMENT OF COMPUTER SCIENCE AND ENGINEERING**

**Seminar report on "Augmented Reality & Virtual Reality"**

Name of the Programme : **Seminar on "Augmented Reality & Virtual Reality"**

Organized by: Department of CSE

Schedule dates: 14-12-2020.

Resource Person: **Dr. Khaleel Ur Rahman Khan, Professor & Dean, Department of CSE ,ACE Engineering College, Hyderabad.**



**Objective of the Program:** When working with augmented reality (AR) and virtual reality (VR) technologies, there are several objectives that can be pursued. These objectives may vary depending on the specific project or application.

**Outcomes of the Seminar:** outcomes highlight the potential impact of AR and VR technologies in various domains, ranging from enhanced user experiences and visualization to training, design, marketing, collaboration, entertainment, and accessibility.

PRINCIPAL

Vignan's Institute of Management & Technology For Women  
Kondapur (V), Ghatkesar (M), Medchal-Malkajgiri (D)-501301  
Telangana State

Coordinator



HOD-CSE

Head of The Department  
Computer Science and Engineering  
Vignan's Institute of Management & Technology For Women  
Kondapur (V), Ghatkesar (M), Medchal-Malkajgiri (D)-501301  
Telangana State



# VIGNAN'S INSTITUTE OF MANAGEMENT AND TECHNOLOGY FOR WOMEN

Sponsored by Lawu Educational Society, Approved by AICTE, New Delhi & Affiliated to JNTUH, Hyderabad, Kondapur (V), Ghatkesar (M), Medchal - Malkajgiri (D) - 501 301 Phone: +91 96529 10002/3



## Work Shop On "Augmented Reality & Virtual Reality"

### II B.Tech I Sem Students List-2020-21

#### Branch :CSE

S. No	ROLL NO	STUDENT NAME	SIGN
1	16UP1A05A9	VUPPALA KEERTHI REDDY	<i>Keerthi</i>
2	18UP1A0542	RAPOLU CHANDANA	<i>chandana</i>
3	19UP1A0501	ALLADI ASHWITHA	<i>ASHWITHA</i>
4	19UP1A0502	ALLAKATTU PRANUSHA	<i>Pranusha</i>
5	19UP1A0503	AMMULA TEJASWI	<i>Tejasw</i>
6	19UP1A0504	BEJAGAM BHAVANA	<i>Bhavana</i>
7	19UP1A0505	BHOOPATHI DEEPTHI	<i>Deepti</i>
8	19UP1A0506	BOGU VYSHNAVI	<i>Vyshnavi</i>
9	19UP1A0507	CHAMANTHULA TEJASWINI	<i>Tejaswini</i>
10	19UP1A0508	CHIKATI LIKHITHA	<i>Likhitha</i>
11	19UP1A0509	CHUNCHU VARSHINI YADAV	<i>Varshini</i>
12	19UP1A0510	G.AKANKASHA	<i>Akankasha</i>
13	19UP1A0511	GADDAM AKSHITHA	<i>Akshitha</i>
14	19UP1A0512	GADDAM JOSHITHA	<i>Joshitha</i>
15	19UP1A0513	GARDAS NIKHITHA	<i>Nikhitha</i>
16	19UP1A0514	GARRE PREETHI	<i>Preethi</i>
17	19UP1A0515	GUDDATI MANOGNYA	<i>Manogna</i>
18	19UP1A0516	KANDUL NETHRA	<i>Nethra</i>
19	19UP1A0517	KANKANALA HARIKA	<i>Harika</i>
20	19UP1A0518	KARNAMPALLY NIHARIKA REDDY	<i>Niharika</i>
21	19UP1A0519	KARANTI CHANDRA LEKHA	<i>Chandrika</i>
22	19UP1A0520	KOMATI REDDY SHREYA REDDY	<i>Shreya</i>
23	19UP1A0521	KOMATI REDDY SOWJANYA	<i>Sowjanya</i>
24	19UP1A0522	KOVURI RADHA	<i>Radha</i>
25	19UP1A0523	KUNTIGORLA TEJASWINI	<i>Tejaswini</i>
26	19UP1A0524	KYATHAM PRAVALIKA	<i>Pravalika</i>
27	19UP1A0525	LIKITHA PAWAR	<i>Pawar</i>
28	19UP1A0526	M GOUTHAMI	<i>Gouthami</i>



*ASH*  
PRINCIPAL  
Vignans Institute of Management & Technology For Women  
Kondapur (V), Ghatkesar (M), Medchal-Malkajgiri (D)-5,  
Telangana State



# VIGNAN'S INSTITUTE OF MANAGEMENT AND TECHNOLOGY FOR WOMEN

Sponsored by Lava Educational Society, Approved by AICTE, New Delhi & Affiliated to JNTUH, Hyderabad.  
Kondapur (V), Ghatkesar (M), Medchal - Malkajgiri (D) - 501 301 Phone: +91 96529 10002/3



29	19UP1A0527	MARADUGU POOJITHA	Poojitha
30	19UP1A0528	MONICA MAHENDRA NUNSAVATH	Monica
31	19UP1A0529	MODDASANI SNEHARSHITHA	Sneharshitha
32	19UP1A0530	MYLAPALLY AMULYA	Amulya
33	19UP1A0531	N SONIYA	Soniya
34	19UP1A0532	NAKIREKANTI SATHVIKA	Sathvika
35	19UP1A0533	NALLA NITHILA	Nithila
36	19UP1A0534	NINDANAMPALLY VAISHNAVI	Vaishnavi
37	19UP1A0535	P AKHILA	Akhila
38	19UP1A0536	PEMMASANI SOWMYA	Sowmya
39	19UP1A0537	PADALA PRASANNA LAHARI	Prasanna
40	19UP1A0538	PAGADALA GAYATHRI	Gayathri
41	19UP1A0539	PATI SRIMUKHI	Srimukhi
42	19UP1A0540	PITTALA SANJANA	Sanjana
43	19UP1A0541	POLA AMBA BHAVANI	Bhavani
44	19UP1A0542	MANSI POLAVENI	Mansi
45	19UP1A0543	PUNEM KEERTHI	Keerthi
46	19UP1A0544	REBBANA SHIVANI	Shivani
47	19UP1A0545	RUDROJU MEGHANA	Meghana
48	19UP1A0546	S AKSHITHA BHAVANI	Akshitha
49	19UP1A0547	S SHRAVANI GOUD	Shravani
50	19UP1A0548	SANDHIREDDY MEGHANA	Meghana
51	19UP1A0549	SHAILAJA ARIGE	Shailaja
52	19UP1A0550	VARKALA SAI DEEPTHI	Sai Deepti
53	19UP1A0551	YESHABOINA SHIREESHA	Shireesha



PRINCIPAL  
Vignans Institute of Management & Technology For Women  
Kondapur (V), Ghatkesar (M), Medchal-Malkajgiri (D)-501301  
Telangana State



# VIGNAN'S INSTITUTE OF MANAGEMENT AND TECHNOLOGY FOR WOMEN

(Sponsored by Lavu Educational Society)

Approved by AICTE, New Delhi & Affiliated to JNTUH, Hyderabad.

Kondapur (V), Ghatkesar (M), Medchal - Malkajgiri (D) - 501 301

Accredited By



In association with:



## CERTIFICATE OF PARTICIPATION

This certificate is presented to Ms. ....GARRE PREETHI.....  
for her participation in a online seminar on "AUGMENTED REALITY AND VIRTUAL REALITY" held on 14<sup>th</sup> DECEMBER, 2020, Organized by the Department of Computer Science and Engineering, in association with Edunet, Hyderabad.



*[Signature]*  
PRINCIPAL

Vignan's Institute of Management & Technology For Women  
Kondapur (V), Ghatkesar (M), Medchal-Malkajgiri (D)-501301  
Telangana State

*[Signature]*  
Co-Ordinator

*[Signature]*  
HoD, CSE

*[Signature]*  
Principal



# VIGNAN'S INSTITUTE OF MANAGEMENT AND TECHNOLOGY FOR WOMEN

Sponsored by Lavu Educational Society, Approved by AICTE, New Delhi & Affiliated to JNTUH, Hyderabad.  
Kondapur (V), Ghatkesar (M), Medchal - Malkajgiri (D) - 501 301 Phone: +91 96529 10002/3



VMTW/CSE/CIR/2020-21/I/05

Date: 17/11/2020

## CIRCULAR

This is to inform the entire faculty and students that there is a three-days online Workshop on "Advanced machine learning Algorithms using Python Programming" scheduled from 19-11-2020 to 21-11-2020. In this regard all the students and faculty members are instructed to attend the workshop to the provided **Link: [meet.google.com/rda-zktz-rjl](https://meet.google.com/rda-zktz-rjl)** to make it Successful.

  
**PRINCIPAL**

PRINCIPAL  
Vignans Institute of Management & Technology For Women  
Kondapur (V), Ghatkesar (M), Medchal - Malkajgiri (D)  
Telangana - 501301

Copy to:

1. CEO for information,
2. IQAC,
3. Admin Office,
4. HODs (CSE, IT, ECE, EEE, BSH),
5. All Notice Boards
6. Circulate to all Class Rooms.
7. File.



  
**PRINCIPAL**  
Vignans Institute of Management & Technology For Women  
Kondapur (V), Ghatkesar (M), Medchal - Malkajgiri (D)  
Telangana - 501301





# VIGNAN'S INSTITUTE OF MANAGEMENT AND TECHNOLOGY FOR WOMEN

(Sponsored by Lavu Educational Society)

Approved by AICTE, New Delhi & Affiliated to JNTUH, Hyderabad,

Kondapur (V), Ghatkesar (M), Medchal - Malkajgiri (D) - 501 301



DEPARTMENT OF COMPUTER SCIENCE AND ENGINEERING

ONLINE WORKSHOP ON

## ADVANCED MACHINE LEARNING ALGORITHMS USING PYTHON PROGRAMMING

19<sup>TH</sup> - 21<sup>ST</sup> NOVEMBER, 2020 @ 10 AM

Google Meet: [Link:meet.google.com/rda-zktz-rjn](https://meet.google.com/rda-zktz-rjn)



Resource Person:  
**Mr. Shaik Rafi,**  
Edunet Foundation,  
Hyderabad.

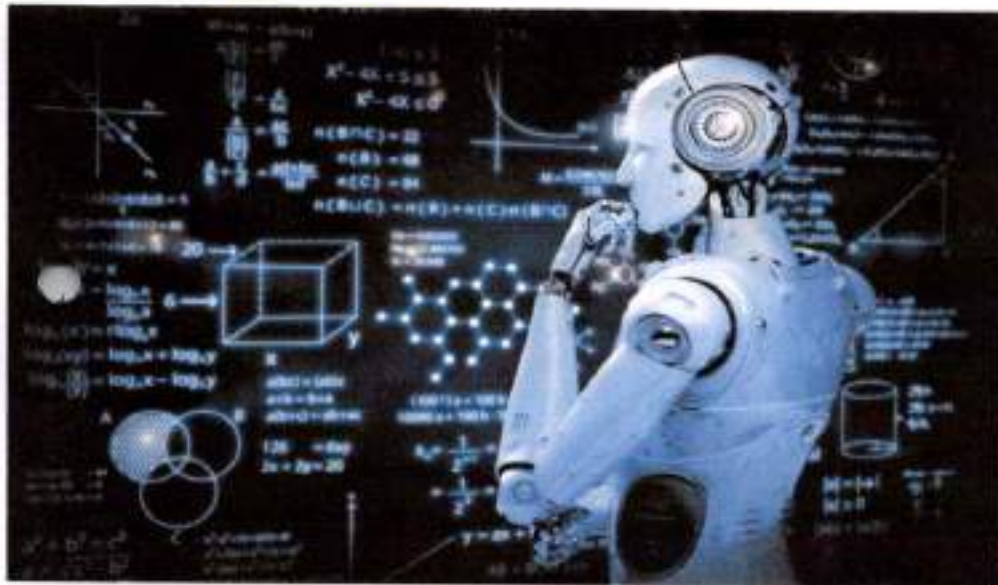

In association with:

edunet

Chief Patron:  
**Dr. Lavu Rethaiah,**  
Chairman, Vignan Group.

Patron:  
**Mr. B. Sravan,**  
CEO, Vignan Group.

Co-Patron:  
**Dr. G. Apparao Naidu,**  
Principal, VMTW.

Advisor:  
**Mrs. V. Indrani,**  
Associate Professor & HOD,  
Dept. of CSE.

Co-Ordinator:  
**Mrs. K. Prathyusha,**  
Assistant Professor, CSE.  
Cell: +91 96529 10002



  
PRINCIPAL  
Vignan's Institute of Management & Technology For Women  
Kondapur (V), Ghatkesar (M), Medchal-Malkajgiri (Dt)-501301  
Telangana State



# VIGNAN'S INSTITUTE OF MANAGEMENT AND TECHNOLOGY FOR WOMEN

Sponsored by Lawu Educational Society, Approved by AICTE, New Delhi & Affiliated to JNTUH, Hyderabad.  
Kondapur (V), Ghatkesar (M), Medchal - Malkajgiri (D) - 501 301 Phone: +91 96529 10002/3



## DEPARTMENT OF COMPUTER SCIENCE AND ENGINEERING

### Report on "Advanced Machine Learning Algorithms using Python programming"

Date: 23-11-2020

<b>Event Type</b>	: OnlineWorkshop
<b>Link</b>	: <a href="https://meet.google.com/rda-zktz-rjl">meet.google.com/rda-zktz-rjl</a>
<b>Total No. of Participants</b>	: 93
<b>Resource Person</b>	: Shaik Rafi, <a href="mailto:rafishaik0404@gmail.com">rafishaik0404@gmail.com</a> .
<b>Name of Coordinator</b>	: Mrs.K.Prathyusha
<b>Date &amp; Time</b>	: 19-11-2020 to 21-11-2020 10:00AM to 4:00PM

#### **Objective of the Event:**

The Main objective of implementing advanced machine learning algorithms using Python programming Improves Prediction Accuracy, Handle Large and Complex Data, Enhance Model Interpretability, Optimize Model Performance, Address Specific Challenges.

#### **Outcomes of the Event:**

The outcome of this online Workshop on "Advanced Machine learning algorithms using Python programming" is, implementing advanced machine learning algorithms using Python programming is to leverage the power of these techniques to achieve better performance, handle complex data, gain interpretability, optimize resource utilization, and solve specific challenges in various domains.



  
PRINCIPAL  
Vignans Institute of Management & Technology For Women  
Kondapur (V), Ghatkesar (M), Medchal-Malkajgiri (D), 501301  
Telangana State



# VIGNAN'S INSTITUTE OF MANAGEMENT AND TECHNOLOGY FOR WOMEN

Sponsored by Lawu Educational Society, Approved by AICTE, New Delhi & Affiliated to JNTUH, Hyderabad.  
Kondapur (V), Ghatkesar (M), Medchal - Malkajgiri (D) - 501 301 Phone: +91 96529 10002/3



After completion of the workshop the students will learn advanced machine learning algorithms often offer higher accuracy compared to simpler models. By implementing these algorithms, and improved prediction.

Total 93 Number of members and 6 numbers of Staff had participated in the workshop. This workshop session had provided an excellent opportunity to learn about **Advanced Machine Learning Algorithms using Python programming**

*Prathiyasha*

**Coordinator**

*V. G. Indira*

**Head of Department**

Head of The Department

Computer Science and Engineering

Vignans Institute of Management & Technology For Women

Kondapur (V), Ghatkesar (M), Medchal-Malkajgiri (D)-501301

Telangana State



*W. Asha*

**PRINCIPAL**

Vignans Institute of Management & Technology For Women  
Kondapur (V), Ghatkesar (M), Medchal-Malkajgiri (D)-501301  
Telangana State

**Student attendance list of three days workshop on  
Advanced Machine Learning Algorithms using Python programming**

**A.Y 2021-2022  
IV YEAR B.TECH (CSE)**

S.No	Roll No	STUDENT NAME	19-NOV	20-NOV	22-NOV
1	15UP1A0516	Dantuluri Alekhya	P	P	P
2	15UP1A0531	Madhunagula Sahithi	P	P	P
3	15UP1A0543	S Aishwarya Lakshmi	P	P	P
4	16UP1A0501	Alugala Sowmya	P	P	P
5	16UP1A0502	Ambati Shivani	P	P	P
6	16UP1A0503	Anagani Meenakshi	P	P	P
7	16UP1A0504	Annadanam Sai Pushyami	P	P	P
8	16UP1A0505	Bandam Sri Varshini	P	P	P
9	16UP1A0506	Beereli Akanksha	P	P	P
10	16UP1A0507	Bhum Sankeerthana	P	P	P
11	16UP1A0508	Boda Ushasri	P	P	P
12	16UP1A0509	Boddu Neelima Yadav	P	P	P
13	16UP1A0510	Boppidi Sindhuma	P	P	P
14	16UP1A0511	Burri Sai Deekshitha	P	P	P
15	16UP1A0513	Chalasani Lakshmi Bhavani	P	P	P
16	16UP1A0514	Devasani Harshitha	P	P	P
17	16UP1A0515	Erugu Saritha	P	P	P
18	16UP1A0516	Gaddikoppula Nagalakshmi	P	A	P
19	16UP1A0518	Ganga Niharika	P	P	P
20	16UP1A0519	Ganne Sai Bhanu	P	P	P
21	16UP1A0522	Jajula Jhansi Goud	P	P	A
22	16UP1A0523	K Keerthi Reddy	A	P	P
23	16UP1A0524	K S Vidya	P	P	P



*AD*  
PRINCIPAL

Vignani's Institute of Management & Technology For Women  
Kondapur (V), Chalkiasar (M), Medchal-Malkajgiri (D)  
Telangana State

24	16UP1A0525	Kamjula Sruthi	P	P	P
25	16UP1A0526	Kandadi Shalini	P	P	P
26	16UP1A0527	Kandula Pavitra	P	P	P
27	16UP1A0528	Kaspa Chandrika	P	P	P
28	16UP1A0529	Kathula Bhavana	P	P	
29	16UP1A0530	Katta Srianusha	P	P	A
30	16UP1A0531	Khanderao Brunda	A	P	P
31	16UP1A0533	Kodavali Sai Manideepa	P	P	P
32	16UP1A0534	Koppolu Swetha	P	P	P
33	16UP1A0535	Kyatham Sujitha	P	P	P
34	16UP1A0536	Mathangodu Aiswarya	P	P	P
35	16UP1A0537	Molia Shanti	P	P	P
36	16UP1A0538	Nallan Chakravarthula Vinissruta	P	P	P
37	16UP1A0539	Nannuri Udayasri	P	P	P
38	16UP1A0540	Nuka Saishma	P	P	P
39	16UP1A0541	Pasala Sindhu Niharika	P		P
40	16UP1A0542	Pilly Supriya	P	P	P
41	16UP1A0543	Polaveni Meghaswi	P	P	P
42	16UP1A0544	Ravula Mounika	P	P	P
43	16UP1A0545	Sagarla Maheshwari	P	P	P
44	16UP1A0546	Samineni Sree Lakshmi	P	P	P
45	16UP1A0547	Sriramoju Swathi	A	P	A
46	16UP1A0548	Surakanti Sirisha	P	P	P
47	16UP1A0549	Thouti Samana	P	P	P
48	16UP1A0550	Undadi Srujana Bharathi	P	P	P
49	16UP1A0551	Uyyala Tejaswini	P	P	P
50	16UP1A0552	Vakiti Sai Sindhu	P	P	P
51	16UP1A0554	Vuppala Sahithi	P	P	P



*ASH*  
PRINCIPAL

Vignans Institute of Management & Technology For Women  
Kondapur (V), Ghatkesar (M), Medchal-Malkajgiri (DI)-501301  
Telangana State

52	16UP1A0555	Yalagala Sahithi	P	P	P
53	16UP1A0556	Yannu Akhila	P	P	P
54	16UP1A0557	A Sai Sree	P	P	P
55	16UP1A0558	A.Sai Srilekha	A	P	P
56	16UP1A0559	Akoju Harika	P	P	P
57	16UP1A0560	Balni Rakshana Angel Reddy	P	P	P
58	16UP1A0561	Banoth Vasavi	A	P	P
59	16UP1A0562	Bichala Sai Lahari	P	P	P
60	16UP1A0563	Byreddy Preethi	P	P	P
61	16UP1A0564	Dama Priyanka	P	P	P
62	16UP1A0565	Dandothkar Madhuri	P	P	P
63	16UP1A0566	Dondapati Sangeetha	P	P	P
64	16UP1A0567	Dosakayala Nikhitha Dutt	P	P	P
65	16UP1A0568	G Shireesha	P	P	A
66	16UP1A0569	Gaddam Preethi	P	P	P
67	16UP1A0570	Gundlapally Manasa	P	P	P
68	16UP1A0571	Hinduraj	P	P	P
69	16UP1A0572	Kakularapu Akhila	P	P	P
70	16UP1A0573	Katamoni Sai Pranavi	P	P	P
71	16UP1A0574	Katta V Shaivalini	P	P	P
72	16UP1A0575	Kolloju Keerthi	A	P	P
73	16UP1A0576	Konda Anjali	P	P	P
74	16UP1A0577	Kotagiri Sai Hema Sagarika	P	P	P
75	16UP1A0578	Kothapeta Manasa	P	P	P
76	16UP1A0579	Kudidi Sai Chandana	P	P	P
77	16UP1A0580	Lakapathri Nithisha	P	P	P
78	16UP1A0581	Lenkala Sathvika	P	P	P
79	16UP1A0582	Malreddy Divya Reddy	P	P	P



  
 PRINCIPAL  
 Vignans Institute of Management & Technology For Women  
 Kondapur (V), Ghadkesar (M), Medchal-Malkajgiri (D), Pin-501301  
 Telangana State

80	16UP1A0583	Mandapally Phani Priya	P	P	P
81	16UP1A0584	Mekala Sharanya	P	P	P
82	16UP1A0585	Mona Mudiraj Mekala	P	A	P
83	16UP1A0586	Muddasani Sravya	P	P	P
84	16UP1A0587	Muktapuram Bhavani	P	P	P
85	16UP1A0588	Naredia Ruchitha	P	A	P
86	16UP1A0589	Neeli Shrenika	P	P	P
87	16UP1A0590	Palabatlal Shivani	P	P	P
88	16UP1A0591	Pallikonda Shravani	P	P	P
89	16UP1A0592	Pasham Spandana	P	P	P
90	16UP1A0593	Pasupuleti Tejaswini	P	P	P
91	16UP1A0594	Patiolla Sravanthi Reddy	P	P	P
92	16UP1A0595	Pendepwar Sailatha	P	P	A
93	16UP1A0596	Penumatcha Durga Sri Lakshmi Namratha	P	P	P

*Bathijur*  
CO-ORDINATOR



*[Signature]*  
PRINCIPAL

Vignans Institute of Management & Technology For Women  
Kondapur (V), Ghoskesar (M), Madchal-Malkajiri (Dt)-501301  
Telangana State



# VIGNAN'S INSTITUTE OF MANAGEMENT AND TECHNOLOGY FOR WOMEN

(Sponsored by Lavu Educational Society)

Approved by AICTE, New Delhi & Affiliated to JNTUH, Hyderabad.

Kondapur (V), Ghatkesar (M), Medchal - Malkajgiri (D) - 501 301

Accredited By



In association with:

edunet

## CERTIFICATE OF PARTICIPATION

This certificate is presented to Ms. .... **BODA USHASRI**.....  
for her participation in a workshop on "ADVANCED MACHINE LEARNING ALGORITHMS USING PYTHON PROGRAMMING" held from 19<sup>TH</sup> - 21<sup>ST</sup> NOVEMBER, 2020, Organized by the Department of Computer Science and Engineering, in association with Edunet, Hyderabad.

Co-Ordinator



HoD, CSE

PRINCIPAL

Vignan's Institute of Management & Technology For Women  
Kondapur (V), Ghatkesar (M), Medchal-Malkajgiri (D)-501301  
Telangana State

Principal





VMTW/IT/CIR/2020-21/11/04

Date: 16/04/2021

CIRCULAR

This is to inform all the faculties and students that there is a Three-Days Online Workshop on "Advanced Frameworks in Java" scheduled on 19-04-2021 to 21-04-2021. In this regard students are instructed to attend the workshop without fail.

  
PRINCIPAL

PRINCIPAL  
Vignani's Institute of Management & Technology For Women  
Kondapur (V), Ghatkesar (M), Medchal-Malkajgiri (Dt)-501301  
Telangana State

Copy to:

1. CEO for information,
2. IQAC,
3. Admin Office,
4. HODs (CSE, IT, ECE, EEE, BSH),
5. All Notice Boards
6. Circulate to all Class Rooms.
7. File.



  
PRINCIPAL  
Vignani's Institute of Management & Technology For Women  
Kondapur (V), Ghatkesar (M), Medchal-Malkajgiri (Dt)-501301  
Telangana State



# VIGNAN'S INSTITUTE OF MANAGEMENT AND TECHNOLOGY FOR WOMEN

(Sponsored by Lavu Educational Society)  
Approved by AICTE, New Delhi & Affiliated to JNTUH, Hyderabad.  
Kondapur (V), Ghatkesar (M), Medchal - Malkajgiri (D) - 501 301



## DEPARTMENT OF INFORMATION TECHNOLOGY

Organizing

# ONLINE WORKSHOP ON ADVANCED FRAMEWORKS IN JAVA PROGRAMMING

### 19<sup>TH</sup> & 21<sup>ST</sup> APRIL, 2021



Resource Person:  
**Mr. T. Komal Srinivas,**  
CEO, Aditi Software,  
Hyderabad.



Chief Patron:  
**Dr. Lavu Rathalah,**  
Chairman, Vignan Group.

Patron:  
**Mr. B. Shrovan,**  
CEO, Vignan Group.

Co-Patron:  
**Dr. G. Apparao Naidu,**  
Principal, VMTW.

Advisor:  
**Mr. B. Phijik,**  
Associate Professor & HOD,  
Dept. of IT.

Co-Ordinator:  
**Mrs. K. Helini,**  
Assistant Professor, IT.  
Cell: +91 96529 10002

In association with:



ADITI SOFTWARE

 **Link: [meet.google.com/mrj-nnpv-gfg](https://meet.google.com/mrj-nnpv-gfg)**



  
PRINCIPAL

Vignan's Institute of Management & Technology For Women  
Kondapur (V), Ghatkesar (M), Medchal-Malkajgiri (D)-501301  
Telangana State



DEPARTMENT OF INFORMATION TECHNOLOGY

Report on "Advanced Frameworks in Java"

Date: 23-04-2021

Event Type : Online Workshop
Total No. of Participants : 35
Resource Person : Komal Srinivas.T
Technical Manager,
Aditi Software Pvt.Ltd.
Name of Coordinator : Mrs. K. Helini

The Online workshop on "Advanced Frameworks in Java" was held on 19-04-2021 through online. The workshop aimed to provide participants with an in-depth understanding of advanced frameworks used in Java development, their features, and how to effectively utilize them to build robust and scalable applications. The workshop was attended by 35 students in online.

Outcomes of the Event:

The workshop on "Advanced Frameworks in Java" provided participants with valuable insights into modern frameworks used in Java development. By focusing on the Spring Framework, Hibernate, and JSF, participants gained practical knowledge and hands-on experience in utilizing these frameworks effectively. The workshop aimed to empower participants to build robust and scalable Java applications, leveraging the power of advanced frameworks.



The feedback received from participants was overwhelmingly positive, highlighting the comprehensive content, interactive sessions, and practical exercises as major strengths of the workshop. Participants expressed their enthusiasm to apply the knowledge gained in their professional projects and further explore advanced frameworks in Java.

Handwritten signature of Helini and the printed name Coordinator



Handwritten signature of the Principal and the printed name PRINCIPAL

Vignan's Institute of Management & Technology For Women
Kondapur (V), Ghatkesar (M), Medchal-Malkajgiri (D)-501301
Telangana State

Handwritten signature of the H.O.D and the printed name Head of the Department
Information Technology
Vignan's Institute of Management & Technology For Women
Kondapur (V), Ghatkesar (M) Medchal-Malkajgiri (D) - 501301

**Online Workshop on "Advanced Frameworks in Java"**

**Date: 19-04-2021 to 21-04-2021**

S.No	Roll No	Student Name	19-Apr	20-Apr	21-Apr
1	19UPIA1201	A Sangeetha	P	P	P
2	19UPIA1202	Adelli Samyuktha Reddy	P	AB	P
3	19UPIA1203	Apuri Sowmya	P	P	P
4	19UPIA1204	B Shreya Reddy	P	P	P
5	19UPIA1205	Bhashetty Anusha	P	P	P
6	19UPIA1206	Beeravally Sai Josmitha	P	P	AB
7	19UPIA1207	Boddu Sathwika	P	P	P
8	19UPIA1208	Lakshmi Sahiti Chalapati	P	P	P
9	19UPIA1209	Gurram Sneha Reddy	P	P	P
10	19UPIA1210	Joginipelly Sahithya	P	P	P
11	19UPIA1211	Kasula Keerthi Reddy	P	AB	P
12	19UPIA1212	Kethepalli Guru Venkata Sai Roopika	P	P	P
13	19UPIA1213	Komuravelly Ashwitha	AB	P	P
14	19UPIA1214	Kothakapu Niharika Reddy	P	P	P
15	19UPIA1215	Ks Krishna	P	P	P
16	19UPIA1216	Lingampally Nishitha	P	P	P
17	19UPIA1217	Malem Vasanthi	P	P	P
18	19UPIA1218	Mahankali Pavani	P	AB	P
19	19UPIA1219	Navya Talasila	P	P	P
20	19UPIA1220	Pailla Sony	P	P	P
21	19UPIA1221	Pallerla Vennela	P	P	P
22	19UPIA1222	Pathipati Shilpa	P	P	P
23	19UPIA1223	Pendam Vincetha	P	P	P
24	19UPIA1224	Sanjana Saraswathi G	P	P	P
25	19UPIA1225	Sridhyanth Keerthi	AB	P	P



*[Signature]*  
PRINCIPAL

Vignans Institute of Management & Technology For Women  
Kondapur (V), Ghafkesar (M), Medchal-Malkajgiri (Dt)-501501  
Telangana State

26	19UP1A1226	Sripathi Harshitha	AB	P	P
27	19UP1A1227	Turlapati Rithika	P	P	P
28	19UP1A1228	Tammali Madhavi	P	P	P
29	19UP1A1229	Thokala Sindhu Reddy	P	AB	P
30	19UP1A1230	Tirukovela Srinidhi	P	P	P
31	19UP1A1231	Turlapati Rupika	P	P	P
32	19UP1A1232	V Akshitha	P	P	AB
33	19UP1A1233	Vaddireddy Meghana	P	P	P
34	19UP1A1234	Vangaveeti Sravani	P	P	P
35	20UP5A1201	Batta Swapna	P	P	P

*Helini*

**COORDINATOR**

*[Signature]*

**HOD-IT**

Head of the Department  
Information Technology  
Vignans Institute of Management & Technology For Women  
Kondapur (V), Ghatkesar (M) Medchal-Malkajgiri (Dt.)-501301



*[Signature]*

**PRINCIPAL**

Vignans Institute of Management & Technology For Women  
Kondapur (V), Ghatkesar (M), Medchal-Malkajgiri (Dt.)-501301  
Telangana State



# VIGNAN'S INSTITUTE OF MANAGEMENT AND TECHNOLOGY FOR WOMEN

(Sponsored by Lavu Educational Society)

Approved by AICTE, New Delhi & Affiliated to JNTUH, Hyderabad.

Kondapur (V), Ghatkesar (M), Medchal - Malkajgiri (D) - 501 301

Accredited By



In association with:



## CERTIFICATE OF PARTICIPATION

This certificate is presented to Ms. L. NISHITHA  
for her participation in a workshop on "ADVANCED FRAMEWORKS IN JAVA PROGRAMMING" held from 19<sup>TH</sup>-21<sup>ST</sup> APRIL, 2021, Organized by the Department of Information Technology, in association with Aditi Software, Hyderabad.



*Heleeni*  
Co-Ordinator

*[Signature]*  
HoD, IT

*[Signature]*  
PRINCIPAL  
Vignans Institute of Management & Technology For Women  
Kondapur (V), Ghatkesar (M), Medchal-Malkajgiri (D)-501301  
Telangana State

*[Signature]*  
Principal



# VIGNAN'S INSTITUTE OF MANAGEMENT AND TECHNOLOGY FOR WOMEN

Sponsored by Lavu Educational Society, Approved by AICTE, New Delhi & Affiliated to JNTUH, Hyderabad.  
Kondapur (V), Ghatkesar (M), Medchal - Malkajgiri (D) - 501 301 Phone: +91 96529 10002/3



## DEPARTMENT OF ELECTRONICS AND COMMUNICATION ENGINEERING

VMTW/ECE/AOC/CIR//2021-22/II/04

18-02-2022

### CIRCULAR

This is to inform all the IV B.Tech ECE students that there will be an Add on course on "Challenges in Design of PSOCs "in association with True chip Pvt Ltd. on 24-02-2022 to 05-04-2022 All students are invited to take part in this course. The participating students will be honored with certificates of participation. During the course you will be encouraged to interact with the speaker and the other participants through the case study discussions. Hence those who are interested can sign in registration form.

HOD.

Head of the Department  
Electronics and Communication Engineering  
Vignan's Institute of Management and Technology for Women  
Kondapur (V), Ghatkesar (M), Medchal - Malkajgiri (D) - 501 301

#### Copy to

- The Principal, for kind information
- IQAC
- Notice board
- II.B. Tech students
- Dept. file

PRINCIPAL

Vignan's Institute of Management & Technology For Women  
Kondapur(V),Ghatkesar(M),Medchal-Malkajgiri(D)-501 301  
Telangana State



## ABOUT THE COURSE

This course is for anyone passionate in learning how a hardware component can be adapted at runtime to better respond to users/environment needs. This adaptation can be provided by the designers, or it can be an embedded characteristic of the system itself. These runtime adaptable systems will be implemented by using FPGA technologies. Within this course we are going to provide a basic understanding on how the FPGAs are working and of the rationale behind the choice of them to implement a desired system.

## COURSE OBJECTIVES

The objectives of the course are to: Learn Programmable Routing and Interconnect. Understand the the various features of PSoC Designer for configuring the digital and analog modules. Explain the the hardware and software components for mixed signal components. Learn the PSoC Hardware Components, PSoC Software Components.



## EXPECTED OUTCOMES

After studying this course, students will be able to:

- Explain the basic concepts and families of PSoC.
- Recognize the various features of PSoC architecture and programmable blocks.
- Analyze the various features of PSoC Designer for configuring the digital and analog modules
- Design the hardware and software components for mixed signal components.
- Develop the programming skills for interfacing various I/O modules to PSoC.

Resource Person:

**Mr. Ranveer Singh,**  
Technical Manager,  
Truechip, Noida.

Co-ordinator:

**Mr. J. Sunil Kumar,**  
Associate Professor,  
Department of ECE,  
Contact No: +91 8374 717668

**LAST DATE FOR REGISTRATION: 22<sup>ND</sup> FEB, 2022**



(Sponsored by Lavu Educational Society)  
Approved by AICTE, New Delhi & Affiliated to JNTUH, Hyderabad.  
Kondapur (V), Ghatkesar (M), Medchal - Malkajgiri (D) - 501 301

ADD-ON COURSE ON

**“CHALLENGES IN  
SYSTEM ON PSoCs”**

**24<sup>TH</sup> FEB TO 5<sup>TH</sup> APR, 2022**

IN ASSOCIATION WITH:



DURATION OF THE COURSE : **32 HRS**

VENUE:

**'B'-BLOCK SEMINAR HALL, VMTW**

ORGANIZED BY:

**DEPARTMENT OF ELECTRONICS AND  
COMMUNICATION ENGINEERING**







# VIGNAN'S INSTITUTE OF MANAGEMENT AND TECHNOLOGY FOR WOMEN

Sponsored by Lavu Educational Society, Approved by AICTE, New Delhi & Affiliated to JNTUH, Hyderabad.  
Kondapur (V), Ghatkesar (M), Medchal - Malkajgiri (D) - 501 301 Phone: +91 96529 10002/3



## DEPARTMENT OF ELECTRONICS AND COMMUNICATION ENGINEERING

ADD ON COURSE NAME: **Challenges in Design of PSOCs**

DAY WISE SCHEDULE SHEET

Academic Year: 2021-2022

Date: 18-02-2022

B.Tech IV-II SEM

SECTION: ECE-A&B

Room number: BFF5

S.No	DAY	Topic	Timings	Duration
1.	24-02-22	System Architecture, Components of the	04:00pm to 05:00pm	1 hour
2.	25-02-22	Hardware & Software, Processor Architectures	04:00pm to 05:00pm	1 hour
3.	26-02-22	Memory and Addressing	04:00pm to 05:00pm	1 hour
4.	28-02-22	System level interconnection	04:00pm to 05:00pm	1 hour
5.	01-03-22	An approach for SOC Design	04:00pm to 05:00pm	1 hour
6.	02-03-22	System Architecture and Complexity	04:00pm to 05:00pm	1 hour
7.	03-03-22	Processors: Introduction, Processor Selection	04:00pm to 05:00pm	1 hour
8.	04-03-22	Basic concepts in Processor Architecture	04:00pm to 05:00pm	1 hour
9.	05-03-22	Basic concepts in Processor Micro	04:00pm to 05:00pm	1 hour
10.	07-03-22	Basic elements in Instruction handling	04:00pm to 05:00pm	1 hour
11.	09-03-22	Buffers: minimizing Pipeline Delays, Branches	04:00pm to 05:00pm	1 hour
12.	10-03-22	More Robust Processors	04:00pm to 05:00pm	1 hour
13.	11-03-22	Vector Processors and Vector Instructions	04:00pm to 05:00pm	1 hour
14.	12-03-22	VLIW Processors, Superscalar Processors	04:00pm to 05:00pm	1 hour
15.	01-03-22	Memory Design for SOC: Overview of SOC	04:00pm to 05:00pm	1 hour
16.	14-03-22	Internal Memory, Size, Scratchpads and Cache	04:00pm to 05:00pm	1 hour
17.	15-03-22	Cache Organization, Cache data, Write	04:00pm to 05:00pm	1 hour
18.	16-03-22	Strategies for line replacement at miss time	04:00pm to 05:00pm	1 hour
19.	19-03-22	Types of Cache, Split - I, and D - Caches	04:00pm to 05:00pm	1 hour
20.	21-03-22	Multilevel Caches, Virtual to real translation	04:00pm to 05:00pm	1 hour
21.	22-03-22	SOC Memory System, Models of Simple	04:00pm to 05:00pm	1 hour
22.	23-03-22	Memory interaction.	04:00pm to 05:00pm	1 hour
23.	24-03-22	Interconnect Customization: Inter Connect	04:00pm to 05:00pm	1 hour
24.	25-03-22	Bus: Basic Architectures	04:00pm to 05:00pm	1 hour
25.	26-03-22	SOC Standard Buses	04:00pm to 05:00pm	1 hour
26.	28-03-22	Analytic Bus Models, Using the Bus model	04:00pm to 05:00pm	1 hour
27.	29-03-22	Effects of Bus transactions and contention	04:00pm to 05:00pm	1 hour



  
PRINCIPAL

Vignans Institute of Management & Technology For Women  
Kondapur(V), Ghatkesar(M), Medchal-Malkajgiri(D)-501301  
Telangana State

28.	30-03-22	Configuration: An overview	04:00pm to 05:00pm	1 hour
29.	31-03-22	Customizing Instruction Processor	04:00pm to 05:00pm	1 hour
30.	01-04-22	Reconfiguration Technologies,	04:00pm to 05:00pm	1 hour
31.	02-04-22	Mapping design onto Reconfigurable devices	04:00pm to 05:00pm	1 hour
32.	04-04-22	Instance- Specific design	04:00pm to 05:00pm	1 hour
33.	05-04-22	Test Conducted and Feedback Form	04:00pm to 05:00pm	1 hour
<b>Total – 33 hours</b>				

  
**CO ORDINATOR**

  
**HOD**

**Head of the Department**  
 Electronics and Communication Engineering  
 Vignan's Institute of Management & Technology For Women  
 Kondapur (M), Ghatkesar (M), Medchal-Malkajgiri, Dist-501301.



  
**PRINCIPAL**

**Vignan's Institute of Management & Technology For Women**  
 Kondapur(V), Ghatkesar(M), Medchal-Malkajgiri, Dist-501301  
 Telangana State



# VIGNAN'S INSTITUTE OF MANAGEMENT AND TECHNOLOGY FOR WOMEN

Sponsored by Lavu Educational Society, Approved by AICTE, New Delhi & Affiliated to JNTU, Hyderabad.  
Kondapur (V), Ghatkesar (M), Medchal - Malkajgiri (D) - 501 301 Phone: +91 96529 10002/3



## DEPARTMENT OF ELECTRONICS AND COMMUNICATION ENGINEERING

ADD ON COURSE NAME: **Challenges in Design of PSOCs**

ADDON COURSE STUDENT REGISTRATION FORM

Academic Year : 2021-2022

Date : 18-02-2022

B.Tech IV-II SEM

SECTION : ECE-A

S.No	Roll Number	Name of the Student	Signature
1.	18UPIA0401	ADDANKI DHARANI	A. Dharani
2.	18UPIA0402	ADUSUMILLI SRILASYA	Srilasya
3.	18UPIA0403	ARROJU VAISHNAVI	Arroju
4.	18UPIA0404	BANDARI MOUNIKA	Mounika
5.	18UPIA0405	BATTULA SANGEETHA	Sangeetha
6.	18UPIA0406	CHINTAKUNTA RASAGNA	Rasagna
7.	18UPIA0407	DAMMANNAPETA SOUJANYA	Soujanya
8.	18UPIA0408	DESHAM SRIVANI	Srivani
9.	18UPIA0409	DIGAJARLA SNEHITHA	Snehitha
10.	18UPIA0410	GAMPALA MADHURI	Madhuri
11.	18UPIA0412	GANDHE AKANKSHA	Akanksha
12.	18UPIA0413	GANNA KAVYA	G. Kavya
13.	18UPIA0414	GATTU MOUNIKA	G. Mounika
14.	18UPIA0415	GIRINENI DIVYA	G. Divya
15.	18UPIA0417	GUNTUPALLI MIDHUNA	Midhuna
16.	18UPIA0418	GURUGUBELLI SUSHMA	Sushma
17.	18UPIA0419	JAGINI SHARANYA	Sharanya
18.	18UPIA0420	JANAGAMA SRIVIDHYA	Srividhya
19.	18UPIA0421	JOGIRAJU AKSHARA	Akshara
20.	18UPIA0422	JONNALAGADDA DEEPTHI	Deepti
21.	18UPIA0423	K HARIPRIYA	Haripriya
22.	18UPIA0424	KANCHARLA SRUTHI	Sruthi
23.	18UPIA0425	KONAMUTLA JHANSI	Jhansi
24.	18UPIA0426	KOTA LIKHITHA	Likhitha
25.	18UPIA0427	KOTHA SWATHI	Swathi
26.	18UPIA0428	KOTLA SONY	K. Sony
27.	18UPIA0429	KOTTAM AKHILA	K. Akhila
28.	18UPIA0430	KUNTA DEEPIKA	Deepika
29.	18UPIA0431	LADALLA PAVANI	Pavani



*[Signature]*  
PRINCIPAL

Vignans Institute of Management & Technology For Women  
Kondapur (V), Ghatkesar (M), Medchal - Malkajgiri (D) - 501301  
Telangana State

30.	18UP1A0432	MADDI SRIVIDYA	Sri Vidya
31.	18UP1A0433	MALAMANTI MOUNIKA	Mounika
32.	18UP1A0434	MAREPALLY ADITI SAI	Aditi
33.	18UP1A0435	MITTA AKSHITHA	-
34.	18UP1A0436	MOROJU KUSUMA	Kusuma
35.	18UP1A0437	MOTAMARRI MEGHANA	Megh
36.	18UP1A0438	N GAYATHRI	Gayathri
37.	18UP1A0439	N RUPARANI	Ru
38.	18UP1A0440	NACHU SHIVANI	-
39.	18UP1A0442	PEDDI AISHWARYA	AISHWARYA
40.	18UP1A0443	PULUSANI VARSHITHA	Varshitha
41.	18UP1A0444	REDDYGARI JAHNAVI REDDY	Jahna
42.	18UP1A0445	SAMALA POOJA	Pooja
43.	18UP1A0446	SHAIK ZEENATH	Zeenath
44.	18UP1A0447	SINGIRIKONDA AISHWARYA	Aishwarya
45.	18UP1A0448	SUKKA SHARANYA	Sharanya
46.	18UP1A0449	SUNKARABOINA AMOOL SIRI	Amool
47.	18UP1A0450	TANGUTURI NIHARIKA	Niharika
48.	18UP1A0451	VEERAMALLA MANASA	Manasa
49.	18UP1A0452	VUPPUGANDLA SREEJA	Sreeja
50.	18UP1A0453	YELLOJU SRAVANI	Sravani
51.	19UP5A0401	ABRABOINA SAIKUMARI	-
52.	19UP5A0402	ADEPU SHIVANI	Shivani
53.	19UP5A0403	BANDI JHANSI	Jhansi
54.	19UP5A0404	BATHINI NIVEDITHA	Niveditha
55.	19UP5A0405	BODDIREDDY RAVALI	-
56.	19UP5A0407	GANDHARI SHAILAJA	Shailaja

  
COORDINATOR

  
HOD

Head of the Department  
Electronics and Communication Engineering  
Vignans Institute of Management & Technology  
Kondapur(V), Ghatkesar(M), Medchal-Malkajgiri(DT)-501301  
Andhra Pradesh



  
PRINCIPAL  
Vignans Institute of Management & Technology For Women  
Kondapur(V), Ghatkesar(M), Medchal-Malkajgiri(DT)-501301  
Telangana State



# VIGNAN'S INSTITUTE OF MANAGEMENT AND TECHNOLOGY FOR WOMEN

Sponsored by Law Educational Society, Approved by AICTE, New Delhi & Affiliated to JNTUH, Hyderabad.  
Kondapur (V), Ghatkesar (M), Medchal - Malkajgiri (D) - 501 301 Phone: +91 96529 10002/3



## DEPARTMENT OF ELECTRONICS AND COMMUNICATION ENGINEERING

ADD ON COURSE NAME: **Challenges in Design of PSOCs**

ADDON COURSE STUDENT REGISTERED LIST

Academic Year : 2021-2022

Date : 18-02-2022

B.Tech IV-II SEM

SECTION : ECE-A

S.No	Roll Number	Name of the Student
1	18UPIA0401	ADDANKI DHARANI
2	18UPIA0402	ADUSUMILLI SRILASYA
3	18UPIA0403	ARROJU VAISHNAVI
4	18UPIA0404	BANDARI MOUNIKA
5	18UPIA0405	BATTULA SANGEETHA
6	18UPIA0406	CHINTAKUNTA RASAGNA
7	18UPIA0407	DAMMANNAPETA SOUJANYA
8	18UPIA0408	DESHAM SRIVANI
9	18UPIA0409	DIGAJARLA SNEHITHA
10	18UPIA0410	GAMPALA MADHURI
11	18UPIA0412	GANDHE AKANKSHA
12	18UPIA0413	GANNA KAVYA
13	18UPIA0414	GATTU MOUNIKA
14	18UPIA0415	GIRINENI DIVYA
15	18UPIA0418	GURUGUBELLI SUSHMA
16	18UPIA0419	JAGINI SHARANYA
17	18UPIA0420	JANAGAMA SRIVIDHYA
18	18UPIA0421	JOGIRAJU AKSHARA
19	18UPIA0422	JONNALAGADDA DEEPTHI
20	18UPIA0423	K HARIPRIYA
21	18UPIA0424	KANCHARLA SRUTHI
22	18UPIA0425	KONAMUTLA JHANSI
23	18UPIA0427	KOTHA SWATHI
24	18UPIA0428	KOTLA SONY
25	18UPIA0429	KOTTAM AKHILA
26	18UPIA0430	KUNTA DEEPIKA
27	18UPIA0431	LADALLA PAVANI
28	18UPIA0432	MADDI SRIVIDYA
29	18UPIA0433	MALAMANTI MOUNIKA



  
PRINCIPAL  
Vignans Institute of Management & Technology For Women  
Kondapur(V), Ghatkesar(M), Medchal-Malkajgiri(D)-501301  
Telangana State

30	18UP1A0434	MAREPALLY ADITI SAI
31	18UP1A0436	MOROJU KUSUMA
32	18UP1A0437	MOTAMARRI MEGHANA
33	18UP1A0438	N GAYATHRI
34	18UP1A0439	N RUPARANI
35	18UP1A0442	PEDDI AISHWARYA
36	18UP1A0443	PULUSANI VARSHITHA
37	18UP1A0444	REDDYGARI JAHNAVI REDDY
38	18UP1A0445	SAMALA POOJA
39	18UP1A0446	SHAIK ZEENATH
40	18UP1A0447	SINGIRIKONDA AISHWARYA
41	18UP1A0448	SUKKA SHARANYA
42	18UP1A0449	SUNKARABOINA AMOOL SIRI
43	18UP1A0450	TANGUTURI NIHARIKA
44	18UP1A0451	VEERAMALLA MANASA
45	18UP1A0452	VUPPUGANDLA SREEJA
46	18UP1A0453	YELLOJU SRAVANI
47	19UP5A0402	ADEPU SHIVANI
48	19UP5A0403	BANDI JHANSI
49	19UP5A0404	BATHINI NIVEDITHA
50	19UP5A0407	GANDHARI SHAILAJA

  
COORDINATOR

  
HOD

Head of the Department  
Electronics and Communication Engineering  
Vignee's Institute of Management & Technology For Women  
Kondapur (V), Ghatkesar (M), Medchal-Malkajgiri (Dt.)-501301



  
PRINCIPAL  
Vignee's Institute of Management & Technology For Women  
Kondapur(V), Ghatkesar(M), Medchal-Malkajgiri(Dt.)-501301  
Telangana State



# VIGNAN'S INSTITUTE OF MANAGEMENT AND TECHNOLOGY FOR WOMEN

Sponsored by Lavu Educational Society, Approved by AICTE, New Delhi & Affiliated to JNTUH, Hyderabad.  
Kondapur (V), Ghatkesar (M), Medchal - Malkajgiri (D) - 501 301 Phone: +91 96529 10002/3



## DEPARTMENT OF ELECTRONICS AND COMMUNICATION ENGINEERING

ADD ON COURSE NAME: **Challenges in Design of PSOCs**

ADDON COURSE STUDENT REGISTRATION FORM

Academic Year : 2021-2022

Date : 18-02-2022

B.Tech IV-II SEM

SECTION : ECE-B

S.No	Roll Number	Name of the Student	Signature
1.	18UPIA0454	ARSHIA JABEEN	[Signature]
2.	18UPIA0455	ATLURU SINDHUJA	[Signature]
3.	18UPIA0456	B SOUMYA	[Signature]
4.	18UPIA0457	MOTUPALLI BHAVANA SAI PRIYA	[Signature]
5.	18UPIA0458	BODDIREDDY SAI ASHRITHA	[Signature]
6.	18UPIA0459	B ABHIGNA	[Signature]
7.	18UPIA0460	BOGGULA VENKATA KRISHNA	[Signature]
8.	18UPIA0461	BORRA LIKITHA	[Signature]
9.	18UPIA0462	C KAVYA SREE	[Signature]
10.	18UPIA0463	CHALASANI SRI SAI BHUVANESWARI	[Signature]
11.	18UPIA0464	CHALLA TEJASWINI	[Signature]
12.	18UPIA0465	GADUSU NAVYA	[Signature]
13.	18UPIA0466	GUMMADEELA LAKSHMI PRASANNA	[Signature]
14.	18UPIA0467	GURRAM SRAVANTHI	[Signature]
15.	18UPIA0468	JAKKA DEEPTHI	[Signature]
16.	18UPIA0469	JAKKA KEERTHI	[Signature]
17.	18UPIA0471	KANDADI POOJA	[Signature]
18.	18UPIA0472	KARI DIVYA SRI SAI DURGA	[Signature]
19.	18UPIA0473	KODALI RUPA	[Signature]
20.	18UPIA0474	KOLA SNIGDHA	[Signature]
21.	18UPIA0475	KOPPULA BHAVANA	[Signature]
22.	18UPIA0476	KURREMULA SAI SOWJANNYA	[Signature]
23.	18UPIA0477	MALKEYAGARU SATHWIK REDDY	[Signature]
24.	18UPIA0478	MANDALA SHRESTA	[Signature]
25.	18UPIA0479	MARAMPALLY APOORVA	[Signature]
26.	18UPIA0480	MOMULA VASANTHA LAXMI	[Signature]
27.	18UPIA0481	M YOSHITHA NAGA SAI LAKSHMI	[Signature]
28.	18UPIA0482	NANDYALA VARSHITHA	[Signature]
29.	18UPIA0483	PODURI MEHER SESHASREE	[Signature]



  
PRINCIPAL  
Vignans Institute of Management & Technology For Women  
Kondapur(V), Ghatkesar(M), Medchal-Malkajgiri(D)-501301  
Telangana State

30.	18UPIA0484	PESARU SHIVANI	
31.	18UPIA0486	P. NAGA VIJAYA VYSHNAVI	<i>Vijaya</i>
32.	18UPIA0487	PAPPULA VARSHITHA	<i>Varshitha</i>
33.	18UPIA0488	PEDDI RASHMITHA	<i>Rashmi</i>
34.	18UPIA0489	PEDDIREDDY PRAVALIKA	
35.	18UPIA0490	PENDYALA BHOOMIKA	<i>P. Bhoomika</i>
36.	18UPIA0491	POCHAMPALLI HARINI	<i>Harini</i>
37.	18UPIA0492	PODDUTURI ANVITHA	<i>Anvitha</i>
38.	18UPIA0493	POTHUGANTI MADHUNITHA	<i>Madhuni</i>
39.	18UPIA0494	PULLURU SRAVANI	
40.	18UPIA0495	PYATA PRANANJALI REDDY	<i>Prananjali</i>
41.	18UPIA0496	SANTI SREEJA REDDY	<i>Sreeja</i>
42.	18UPIA0497	SARANGA NAVYA SRI	<i>NAVYA SRI</i>
43.	18UPIA0498	SAVIRIGAM SRAVYA	<i>Sravya</i>
44.	18UPIA0499	SUDHAGONI SINDHU	<i>Sindhu</i>
45.	18UPIA04A0	TENKASALA SHRUTHI MADHURI	<i>Madhuri</i>
46.	18UPIA04A1	VEERAMREDDY SATVIKA	<i>Satvika</i>
47.	18UPIA04A2	VUYYALA SREEJA	<i>Sreeja</i>
48.	18UPIA04A3	YERRA SUSHMITHA	<i>Sushmitha</i>
49.	19UP5A0408	K RENUKA	<i>Renuka</i>
50.	19UP5A0409	NIMMA JHANSI	<i>Jhansi</i>
51.	19UP5A0410	NURCHU SHIRISHA	
52.	19UP5A0411	NUTENKI SINDHU	<i>Sindhu</i>
53.	19UP5A0412	POOSALA KEERTHY	<i>Keerthy</i>
54.	19UP5A0413	S. AKHILA	<i>Akhila</i>
55.	19UP5A0414	VORUGANTI AKANKASHA	

*[Signature]*  
COORDINATOR

*[Signature]*  
HOD

Head of the Department  
Electronics and Communication Engineering  
Vignans Institute of Management & Technology For Women  
Kondapur (V), Ghatkesar (M), Medchal-Malkajgiri (Dt) - 501301  
Dist-01 101



*[Signature]*  
PRINCIPAL

Vignans Institute of Management & Technology For Women  
Kondapur(V), Ghatkesar(M), Medchal-Malkajgiri(Dt)-501301  
Telangana State





# VIGNAN'S INSTITUTE OF MANAGEMENT AND TECHNOLOGY FOR WOMEN

Sponsored by Laxmi Educational Society, Approved by AICTE, New Delhi & Affiliated to JNTUH, Hyderabad.  
Kondapur (V), Ghatkesar (M), Medchal - Malkajgiri (D) - 501 301 Phone: +91 96529 10002/3



## DEPARTMENT OF ELECTRONICS AND COMMUNICATION ENGINEERING

ADD ON COURSE NAME: **Challenges in Design of PSOCs**

ADDON COURSE STUDENT REGISTERED LIST

Academic Year : 2021-2022

Date : 18-02-2021

B.Tech IV-II SEM

SECTION : ECE-B

S.No	Roll Number	Name of the Student
1	18UP1A0454	ARSHIA JABEEN
2	18UP1A0455	ATLURU SINDHUJA
3	18UP1A0456	B SOUMYA
4	18UP1A0457	MOTUPALLI BHAVANA SAI PRIYA
5	18UP1A0458	BODDIREDDY SAI ASHRITHA
6	18UP1A0459	B ABHIGNA
7	18UP1A0460	BOGGULA VENKATA KRISHNA
8	18UP1A0461	BORRA LIKITHA
9	18UP1A0462	C KAVYA SREE
10	18UP1A0464	CHALLA TEJASWINI
11	18UP1A0465	GADUSU NAVYA
12	18UP1A0466	GUMMADEELA LAKSHMI PRASANNA
13	18UP1A0467	GURRAM SRAVANTHI
14	18UP1A0468	JAKKA DEEPTHI
15	18UP1A0469	JAKKA KEERTHI
16	18UP1A0471	KANDADI POOJA
17	18UP1A0472	KARI DIVYA SRI SAI DURGA
18	18UP1A0473	KODALI RUPA
19	18UP1A0475	KOPPULA BHAVANA
20	18UP1A0476	KURREMULA SAI SOWJANNYA
21	18UP1A0477	MALKEY AGARU SATHWIKI REDDY
22	18UP1A0478	MANDALA SHRESTA
23	18UP1A0479	MARAMPALLY APOORVA
24	18UP1A0480	MOMULA VASANTHA LAXMI
25	18UP1A0481	MULLAPUDI YOSHITHA NAGA SAI LAKSHMI
26	18UP1A0482	NANDYALA VARSHITHA
27	18UP1A0484	PESARU SHIVANI
28	18UP1A0486	P.NAGAVIJAYA VYSHNAVI
29	18UP1A0487	PAPPULA VARSHITHA



  
PRINCIPAL  
Vignans Institute of Management & Technology For Women  
Kondapur(V), Ghatkesar(M), Medchal-Malkajgiri(D)-501301  
Telangana State

30	18UP1A0488	PEDDI RASHMITHA
31	18UP1A0490	PENDYALA BHOOMIKA
32	18UP1A0491	POCHAMPALLI HARINI
33	18UP1A0492	PODDUTURI ANVITHA
34	18UP1A0493	POTHUGANTI MADHUNITHA
35	18UP1A0495	PYATA PRANANJALI REDDY
36	18UP1A0496	SANTI SREEJA REDDY
37	18UP1A0497	SARANGA NAVYA SRI
38	18UP1A0498	SAVIRIGAM SRAVYA
39	18UP1A0499	SUDHAGONI SINDHU
40	18UP1A04A0	TENKASALA SHRUTHI MADHURI
41	18UP1A04A1	VEERAMREDDY SATVIKA
42	18UP1A04A2	VUYYALA SREEJA
43	18UP1A04A3	YERRA SUSHMITHA
44	19UP5A0408	K RENUKA
45	19UP5A0409	NIMMA JHANSI
46	19UP5A0411	NUTENKI SINDHU
47	19UP5A0412	POOSALA KEERTHY
48	19UP5A0413	S. AKHILA

  
COORDINATOR

  
HOD

Head of the Department  
Electronics and Communication Engineering  
Vignans Institute of Management & Technology For Women  
Kondapur (V), Ghatkesar (M), Medchal-Malkajgiri (DT)-501301



  
PRINCIPAL

Vignans Institute of Management & Technology For Women  
Kondapur(V), Ghatkesar(M), Medchal-Malkajgiri(DT)-501301  
Telangana State



# VIGNAN'S INSTITUTE OF MANAGEMENT AND TECHNOLOGY FOR WOMEN

Sponsored by Lawu Educational Society, Approved by AICTE, New Delhi & Affiliated to JNTUH, Hyderabad  
Kondapur (V), Ghatkesar (M), Medchal - Malkajgiri (D) - 501 301 Phone: +91 96529 10002/3



## DEPARTMENT OF ELECTRONICS AND COMMUNICATION ENGINEERING

ADD ON COURSE NAME: **Challenges in Design of PSOCs**

DAY WISE ATTENDANCE SHEET

Academic Year : 2021-2022

Date : 24-02-2022

B.Tech IV-II SEM

SECTION : ECE-A

S.No	Roll number	24-02-22	25-02-22	26-02-22	28-02-22	01-03-22
1	18UPIA0401	A.Dharani	A.Dharani	A.Dharani	A.Dharani	A.Dharani
2	18UPIA0402	Snilasya	Snilasya	Snilasya	Snilasya	Snilasya
3	18UPIA0403	inf	inf	inf	inf	inf
4	18UPIA0404	Mounika	Mounika	Mounika	Mounika	Mounika
5	18UPIA0405	RD	RD	RD	RD	RD
6	18UPIA0406	Rau	Rau	Rau	Rau	Rau
7	18UPIA0407	Soujanya	Soujanya	Soujanya	Soujanya	Soujanya
8	18UPIA0408	Sarany	Sarany	Sarany	Sarany	Sarany
9	18UPIA0409	Shelkita	Shelkita	Shelkita	Shelkita	Shelkita
10	18UPIA0410	in	in	in	in	in
11	18UPIA0412	G.Akansa	G.Akansa	G.Akansa	G.Akansa	G.Akansa
12	18UPIA0413	G.Kavya	G.Kavya	G.Kavya	G.Kavya	G.Kavya
13	18UPIA0414	G.mounika	G.mounika	G.mounika	G.mounika	G.mounika
14	18UPIA0415	G.Divya	G.Divya	G.Divya	G.Divya	G.Divya
15	18UPIA0418	G.Sushma	G.Sushma	G.Sushma	G.Sushma	G.Sushma
16	18UPIA0419	Sharanys	Sharanys	Sharanys	Sharanys	Sharanys
17	18UPIA0420	sei vidhya	sei vidhya	sei vidhya	sei vidhya	sei vidhya
18	18UPIA0421	Atchasa	Atchasa	Atchasa	Atchasa	Atchasa
19	18UPIA0422	Deepthi	Deepthi	Deepthi	Deepthi	Deepthi
20	18UPIA0423	Flarsi	Flarsi	Flarsi	Flarsi	Flarsi
21	18UPIA0424	is	is	is	is	is
22	18UPIA0425	Thari	Thari	Thari	Thari	Thari
23	18UPIA0427	Sudhi	Sudhi	Sudhi	Sudhi	Sudhi
24	18UPIA0428	K.SONY	K.SONY	K.SONY	K.SONY	K.SONY
25	18UPIA0429	K.Akhila	K.Akhila	K.Akhila	K.Akhila	K.Akhila
26	18UPIA0430	Deepika	Deepika	Deepika	Deepika	Deepika
27	18UPIA0431	Parvni	Parvni	Parvni	Parvni	Parvni
28	18UPIA0432	Sri Vidya	Sri Vidya	Sri Vidya	Sri Vidya	Sri Vidya
29	18UPIA0433	Mounika	Mounika	Mounika	Mounika	Mounika



*[Signature]*  
PRINCIPAL

Vignans Institute of Management & Technology For Women  
Kondapur(V), Ghatkesar(M), Medchal-Malkajgiri(D)-501301  
Telangana State

30	18UP1A0434	Aditi	Aditi	Aditi	Aditi	Aditi
31	18UP1A0436	Kusuma	Kusuma	Kusuma	Kusuma	Kusuma
32	18UP1A0437	(M)	(M)	(M)	(M)	(M)
33	18UP1A0438	Gayathri	Gayathri	Gayathri	Gayathri	Gayathri
34	18UP1A0439	(P)	(P)	(P)	(P)	(P)
35	18UP1A0442	AISHWARYA	AISHWARYA	AISHWARYA	AISHWARYA	AISHWARYA
36	18UP1A0443	Varshitha	AP	Varshitha	Varshitha	Varshitha
37	18UP1A0444	Jahat	Jahat	Jahat	Jahat	Jahat
38	18UP1A0445	Deepa	Deepa	Deepa	Deepa	Deepa
39	18UP1A0446	zeenath	zeenath	zeenath	zeenath	zeenath
40	18UP1A0447	Aishwarya	Aishwarya	Aishwarya	Aishwarya	Aishwarya
41	18UP1A0448	Sharanya	Sharanya	Sharanya	Sharanya	Sharanya
42	18UP1A0449	(AS)	(AS)	(AS)	(AS)	(AS)
43	18UP1A0450	Nilai	Nilai	Nilai	Nilai	Nilai
44	18UP1A0451	Manasa	Manasa	Manasa	Manasa	Manasa
45	18UP1A0452	Sreeraj	Sreeraj	Sreeraj	Sreeraj	Sreeraj
46	18UP1A0453	Soravani	Soravani	Soravani	Soravani	Soravani
47	19UP5A0402	Shirani	Shirani	Shirani	Shirani	Shirani
48	19UP5A0403	ilani	ilani	ilani	ilani	ilani
49	19UP5A0404	Niveditha	Niveditha	Niveditha	Niveditha	Niveditha
50	19UP5A0407	Shailaja	Shailaja	Shailaja	Shailaja	Shailaja

  
COORDINATOR

  
HOD

Head of the Department  
Electronics and Communication Engineering  
Vignar's Institute of Management & Technology For Women  
Kondapur (V), Ghatkesar (M), Medchal-Malkajgiri (DL)-501301



  
PRINCIPAL

Vignar's Institute of Management & Technology For Women  
Kondapur(V), Ghatkesar(M), Medchal-Malkajgiri(DL)-501301  
Telangana State



# VIGNAN'S INSTITUTE OF MANAGEMENT AND TECHNOLOGY FOR WOMEN

Sponsored by Law Educational Society, Approved by AICTE, New Delhi & Affiliated to JNTUH, Hyderabad.  
Kondapur (V), Ghatkesar (M), Medchal - Malkajgiri (D) - 501 301 Phone: +91 98529 10002/3



## DEPARTMENT OF ELECTRONICS AND COMMUNICATION ENGINEERING

ADD ON COURSE NAME: **Challenges in Design of PSOCs**

DAY WISE ATTENDANCE SHEET

Academic Year : 2021-2022

Date : 24-02-2022

B.Tech IV-II SEM

SECTION : ECE-B

S.No	Roll Number	24-02-22	25-02-22	26-02-22	28-02-22	01-03-22
1	18UPIA0454	[Signature]	[Signature]	[Signature]	[Signature]	[Signature]
2	18UPIA0455	[Signature]	[Signature]	[Signature]	[Signature]	[Signature]
3	18UPIA0456	[Signature]	[Signature]	[Signature]	[Signature]	[Signature]
4	18UPIA0457	Saipriya	Saipriya	Saipriya	Saipriya	Saipriya
5	18UPIA0458	Srujanthra	Srujanthra	Srujanthra	Srujanthra	Srujanthra
6	18UPIA0459	Abhigna	Abhigna	Abhigna	Abhigna	Abhigna
7	18UPIA0460	Venkata Kavya	Venkata Kavya	Venkata Kavya	Venkata Kavya	Venkata Kavya
8	18UPIA0461	Likitha	Likitha	Likitha	Likitha	Likitha
9	18UPIA0462	Kavya Sree	Kavya Sree	Kavya Sree	Kavya Sree	Kavya Sree
10	18UPIA0464	Teja	Teja	Teja	Teja	Teja
11	18UPIA0465	Navya	Navya	Navya	Navya	Navya
12	18UPIA0466	G. Lakshmi	G. Lakshmi	G. Lakshmi	G. Lakshmi	G. Lakshmi
13	18UPIA0467	G. Saravathi	G. Saravathi	G. Saravathi	G. Saravathi	G. Saravathi
14	18UPIA0468	[Signature]	[Signature]	[Signature]	[Signature]	[Signature]
15	18UPIA0469	Keerthi	Keerthi	Keerthi	Keerthi	Keerthi
16	18UPIA0471	Pooja	Pooja	Pooja	Pooja	Pooja
17	18UPIA0472	Durga	Durga	Durga	Durga	Durga
18	18UPIA0473	Rupa	Rupa	Rupa	Rupa	Rupa
19	18UPIA0475	K. Bhavana	K. Bhavana	K. Bhavana	K. Bhavana	K. Bhavana
20	18UPIA0476	[Signature]	[Signature]	[Signature]	[Signature]	[Signature]
21	18UPIA0477	Sath	Sath	Sath	Sath	Sath
22	18UPIA0478	Shaesta	Shaesta	Shaesta	Shaesta	Shaesta
23	18UPIA0479	[Signature]	[Signature]	[Signature]	[Signature]	[Signature]
24	18UPIA0480	Lakshmi	Lakshmi	Lakshmi	Lakshmi	Lakshmi
25	18UPIA0481	Lakshmi	Lakshmi	Lakshmi	Lakshmi	Lakshmi
26	18UPIA0482	Varshitha	Varshitha	Varshitha	Varshitha	Varshitha
27	18UPIA0484	[Signature]	[Signature]	[Signature]	[Signature]	[Signature]
28	18UPIA0486	[Signature]	[Signature]	[Signature]	[Signature]	[Signature]
29	18UPIA0487	Varshitha	Varshitha	Varshitha	Varshitha	Varshitha



*[Signature]*

PRINCIPAL

Vignans Institute of Management & Technology For Women  
Kondapur(V), Ghatkesar(M), Medchal-Malkajgiri(D)-501301  
Telangana State

30	18UPIA0488	Rup	Rup	Rup	Rup	Rup	Rup
31	18UPIA0490	P.Bhoomika	P.Bhoomika	P.Bhoomika	P.Bhoomika	P.Bhoomika	P.Bhoomika
32	18UPIA0491	P.Harini	P.Harini	P.Harini	P.Harini	P.Harini	P.Harini
33	18UPIA0492	Anitha	Anitha	Anitha	Anitha	Anitha	Anitha
34	18UPIA0493	Madhumitha	Madhumitha	Madhumitha	Madhumitha	Madhumitha	Madhumitha
35	18UPIA0495	Pranayali	Pranayali	Pranayali	Pranayali	Pranayali	Pranayali
36	18UPIA0496	-SP	-SP	-SP	-SP	-SP	-SP
37	18UPIA0497	NAVYASRI	NAVYASRI	NAVYASRI	NAVYASRI	NAVYASRI	NAVYASRI
38	18UPIA0498	Sravya	Sravya	Sravya	Sravya	Sravya	Sravya
39	18UPIA0499	Srithu	Srithu	Srithu	Srithu	Srithu	Srithu
40	18UPIA04A0	Madhavi	Madhavi	Madhavi	Madhavi	Madhavi	Madhavi
41	18UPIA04A1	Satvika	Satvika	Satvika	Satvika	Satvika	Satvika
42	18UPIA04A2	Sreeraj	Sreeraj	Sreeraj	Sreeraj	Sreeraj	Sreeraj
43	18UPIA04A3	Sushmita	Sushmita	Sushmita	Sushmita	Sushmita	Sushmita
44	19UPS A0408	Renuka	Renuka	Renuka	Renuka	Renuka	Renuka
45	19UPS A0409	Shasi	Shasi	Shasi	Shasi	Shasi	Shasi
46	19UPS A0411	Sindhu	Sindhu	Sindhu	Sindhu	Sindhu	Sindhu
47	19UPS A0412	Keerthy	Keerthy	Keerthy	Keerthy	Keerthy	Keerthy
48	19UPS A0413	Akhila	Akhila	Akhila	Akhila	Akhila	Akhila

  
COORDINATOR

  
HOD

Head of the Department  
Electronics and Communication Engineering  
Vignans Institute of Management & Technology For Women  
Kondapur (V), Ghatkesar (M), Medchal-Malkajgiri (Dt.)-501301



  
PRINCIPAL  
Vignans Institute of Management & Technology For Women  
Kondapur(V), Ghatkesar(M), Medchal-Malkajgiri(Dt.)-501301  
Telangana State



# VIGNAN'S INSTITUTE OF MANAGEMENT AND TECHNOLOGY FOR WOMEN

Sponsored by Lavu Educational Society, Approved by AICTE, New Delhi & Affiliated to JNTUH, Hyderabad.  
Kondapur (V), Ghatkesar (M), Medchal - Malkajgiri (D) - 501 301 Phone: +91 96529 10002/3



## DEPARTMENT OF ELECTRONICS AND COMMUNICATION ENGINEERING

ADD ON COURSE NAME: **Challenges in Design of PSOCs**

DAY WISE ATTENDANCE SHEET

Academic Year: 2021-2022

Date: 02-03-2022

B. Tech IV-II SEM

SECTION: ECE-A

S.No	Roll Number	02-03-22	03-03-22	04-03-22	05-03-22	07-03-22
1	18UPIA0401	A.Dharani	A.Dharani	A.Dharani	A.Dharani	A.Dharani
2	18UPIA0402	Srilaxya	Srilaxya	Srilaxya	Srilaxya	Srilaxya
3	18UPIA0403	the J	the J	the J	the J	the J
4	18UPIA0404	MOUNIKS	MOUNIKS	MOUNIKS	MOUNIKS	MOUNIKS
5	18UPIA0405	RS	RS	RS	RS	RS
6	18UPIA0406	Rav	Rav	Rav	Rav	Rav
7	18UPIA0407	Soujanya	Soujanya	Soujanya	Soujanya	Soujanya
8	18UPIA0408	swami	swami	swami	swami	swami
9	18UPIA0409	Snehittha	Snehittha	Snehittha	Snehittha	Snehittha
10	18UPIA0410	Ge	Ge	Ge	Ge	Ge
11	18UPIA0412	G.Akansa	G.Akansa	G.Akansa	G.Akansa	G.Akansa
12	18UPIA0413	G.Kavya	G.Kavya	G.Kavya	G.Kavya	G.Kavya
13	18UPIA0414	G.mounika	G.mounika	G.mounika	G.mounika	G.mounika
14	18UPIA0415	G.Divya	G.Divya	G.Divya	G.Divya	G.Divya
15	18UPIA0418	G.sushma	G.sushma	G.sushma	G.sushma	G.sushma
16	18UPIA0419	Sharanya	Sharanya	Sharanya	Sharanya	Sharanya
17	18UPIA0420	Saividhya	Saividhya	Saividhya	Saividhya	Saividhya
18	18UPIA0421	Akshara	Akshara	Akshara	Akshara	Akshara
19	18UPIA0422	Deepthi	Deepthi	Deepthi	Deepthi	Deepthi
20	18UPIA0423	Flazi	Flazi	Flazi	Flazi	Flazi
21	18UPIA0424	SS	SS	SS	SS	SS
22	18UPIA0425	thasi	thasi	thasi	thasi	thasi
23	18UPIA0427	Swati	Swati	Swati	Swati	Swati
24	18UPIA0428	K.Sony	K.Sony	K.Sony	K.Sony	K.Sony
25	18UPIA0429	K.Akhila	K.Akhila	K.Akhila	K.Akhila	K.Akhila
26	18UPIA0430	Deepika	Deepika	Deepika	Deepika	Deepika
27	18UPIA0431	Parvati	Parvati	Parvati	Parvati	Parvati
28	18UPIA0432	Sri Vidya	Sri Vidya	Sri Vidya	Sri Vidya	Sri Vidya
29	18UPIA0433	Mounika	Mounika	Mounika	Mounika	Mounika



*[Signature]*

PRINCIPAL

Vignans Institute of Management & Technology For Women  
Kondapur(V), Ghatkesar(M), Medchal-Malkajgiri(D)-501 301  
Telangana State



# VIGNAN'S INSTITUTE OF MANAGEMENT AND TECHNOLOGY FOR WOMEN

Sponsored by Lawu Educational Society, Approved by AICTE, New Delhi & Affiliated to JNTUH, Hyderabad.  
Kondapur (V), Ghatkesar (M), Medchal - Malkajgiri (D) - 501 301 Phone: +91 96529 10002/3



## DEPARTMENT OF ELECTRONICS AND COMMUNICATION ENGINEERING

ADD ON COURSE NAME: **Challenges in Design of PSOCs**

DAY WISE ATTENDANCE SHEET

Academic Year: 2021-2022

Date : 02-03-2022

B. Tech IV-II SEM

SECTION : ECE-B

S.No	Roll Number	02-03-22	03-03-22	04-03-22	05-03-22	07-03-22
1	18UPIA0454	Arif	Arif	Arif	Arif	Arif
2	18UPIA0455	Su	Su	Su	Su	Su
3	18UPIA0456	Su	Su	Su	Su	Su
4	18UPIA0457	Srimya	Srimya	Srimya	Srimya	Srimya
5	18UPIA0458	Su Ashmita	Su Ashmita	Su Ashmita	Su Ashmita	Su Ashmita
6	18UPIA0459	Abhinava	Abhinava	Abhinava	Abhinava	Abhinava
7	18UPIA0460	venkata lakshmi	venkata lakshmi	venkata lakshmi	venkata lakshmi	venkata lakshmi
8	18UPIA0461	Likitha	Likitha	Likitha	Likitha	Likitha
9	18UPIA0462	Kavyasree	Kavyasree	Kavyasree	Kavyasree	Kavyasree
10	18UPIA0464	Teja	Teja	Teja	Teja	Teja
11	18UPIA0465	Aranya	Aranya	Aranya	Aranya	Aranya
12	18UPIA0466	G.Lakshmi	G.Lakshmi	G.Lakshmi	G.Lakshmi	G.Lakshmi
13	18UPIA0467	G.Saravathi	G.Saravathi	G.Saravathi	G.Saravathi	G.Saravathi
14	18UPIA0468	Arif	Arif	Arif	Arif	Arif
15	18UPIA0469	Keerthi	Keerthi	Keerthi	Keerthi	Keerthi
16	18UPIA0471	Priya	Priya	Priya	Priya	Priya
17	18UPIA0472	Divya	Divya	Divya	Divya	Divya
18	18UPIA0473	Rupa	Rupa	Rupa	Rupa	Rupa
19	18UPIA0475	K.Bhavana	K.Bhavana	K.Bhavana	K.Bhavana	K.Bhavana
20	18UPIA0476	Arif	Arif	Arif	Arif	Arif
21	18UPIA0477	Sathya	Sathya	Sathya	Sathya	Sathya
22	18UPIA0478	Shrestha	Shrestha	Shrestha	Shrestha	Shrestha
23	18UPIA0479	Arif	Arif	Arif	Arif	Arif
24	18UPIA0480	Varshitha	Varshitha	Varshitha	Varshitha	Varshitha
25	18UPIA0481	Lakshmi	Lakshmi	Lakshmi	Lakshmi	Lakshmi
26	18UPIA0482	Varshitha	Varshitha	Varshitha	Varshitha	Varshitha
27	18UPIA0484	Su	Su	Su	Su	Su
28	18UPIA0486	Varshitha	Varshitha	Varshitha	Varshitha	Varshitha
29	18UPIA0487	Varshitha	Varshitha	Varshitha	Varshitha	Varshitha



*[Signature]*  
PRINCIPAL  
Vignans Institute of Management & Technology For Women  
Kondapur (V), Ghatkesar (M), Medchal - Malkajgiri (D) - 501 301  
Telangana State



30	18UPIA0434	Aditi	Aditi	Aditi	Aditi	Aditi
31	18UPIA0436	Kusuma	Kusuma	Kusuma	Kusuma	Kusuma
32	18UPIA0437	(M)	(M)	(M)	(M)	(M)
33	18UPIA0438	Gayathri	Gayathri	Gayathri	Gayathri	Gayathri
34	18UPIA0439	(P)	(P)	(P)	(P)	(P)
35	18UPIA0442	AISHWARYA	AISHWARYA	AISHWARYA	AISHWARYA	AISHWARYA
36	18UPIA0443	Valshitha	Valshitha	Valshitha	Valshitha	Valshitha
37	18UPIA0444	Jahat	Jahat	Jahat	Jahat	Jahat
38	18UPIA0445	Pooja	Pooja	Pooja	Pooja	Pooja
39	18UPIA0446	Zeenath	Zeenath	Zeenath	Zeenath	Zeenath
40	18UPIA0447	Aishwarya	Aishwarya	Aishwarya	Aishwarya	Aishwarya
41	18UPIA0448	sharanya	(M)	sharanya	sharanya	sharanya
42	18UPIA0449	(Asst)	(Asst)	(Asst)	(Asst)	(Asst)
43	18UPIA0450	Nilavile	Nilavile	Nilavile	Nilavile	Nilavile
44	18UPIA0451	Manasa	Manasa	Manasa	Manasa	Manasa
45	18UPIA0452	Sreeja	Sreeja	Sreeja	Sreeja	Sreeja
46	18UPIA0453	Soravani	Soravani	Soravani	Soravani	Soravani
47	19UPS A0402	Shivani	Shivani	Shivani	Shivani	Shivani
48	19UPS A0403	Ilans	Ilans	Ilans	Ilans	Ilans
49	19UPS A0404	Niveditha	Niveditha	Niveditha	Niveditha	Niveditha
50	19UPS A0407	Shalaja	Shalaja	Shalaja	Shalaja	Shalaja

  
COORDINATOR

  
HOD

Head of the Department  
Electronics and Communication Engineering  
Vignana's Institute of Management & Technology For Women  
Kondapur (V), Ghatkesar (M), Medchal-Malkajgiri (Dt.)-501301



  
PRINCIPAL

Vignana's Institute of Management & Technology For Women  
Kondapur (V), Ghatkesar (M), Medchal-Malkajgiri (Dt.)-501301  
Telangana State

30	18UP1A0488	Raj	Raj	Raj	Raj	Raj
31	18UP1A0490	P.Bhoomika	P.Bhoomika	P.Bhoomika	P.Bhoomika	P.Bhoomika
32	18UP1A0491	P.Hasini	P.Hasini	P.Hasini	P.Hasini	P.Hasini
33	18UP1A0492	Anvitha	Anvitha	Anvitha	Anvitha	Anvitha
34	18UP1A0493	Madhusitha	Madhusitha	Madhusitha	Madhusitha	Madhusitha
35	18UP1A0495	Prananjali	Prananjali	Prananjali	Prananjali	Prananjali
36	18UP1A0496	-SP	-SP	-SP	-SP	-SP
37	18UP1A0497	NAVYASRI	NAVYASRI	NAVYASRI	NAVYASRI	NAVYASRI
38	18UP1A0498	Sravya	Sravya	Sravya	Sravya	Sravya
39	18UP1A0499	Srinthu	Srinthu	Srinthu	Srinthu	Srinthu
40	18UP1A04A0	Madhusri	Madhusri	Madhusri	Madhusri	Madhusri
41	18UP1A04A1	Satvika	Satvika	Satvika	Satvika	Satvika
42	18UP1A04A2	Preja	Preja	Preja	Preja	Preja
43	18UP1A04A3	Sushmita	Sushmita	Sushmita	Sushmita	Sushmita
44	19UP5A0408	Renuka	Renuka	Renuka	Renuka	Renuka
45	19UP5A0409	Shard	Shard	Shard	Shard	Shard
46	19UP5A0411	Sindhu	Sindhu	Sindhu	Sindhu	Sindhu
47	19UP5A0412	Keerthy	Keerthy	Keerthy	Keerthy	Keerthy
48	19UP5A0413	Akhila	Akhila	Akhila	Akhila	Akhila

  
COORDINATOR

  
HOD

Head of the Department  
Electronics and Communication Engineering  
Vignans Institute of Management & Technology For Women  
Kondapur (V), Ghatawar (M), Medchal-Malkajgiri (Dt.)-501301



  
PRINCIPAL

Vignans Institute of Management & Technology For Women  
Kondapur(V), Ghatawar(M), Medchal-Malkajgiri(Dt.)-501301  
Telangana State



# VIGNAN'S INSTITUTE OF MANAGEMENT AND TECHNOLOGY FOR WOMEN

Sponsored by Laxmi Educational Society, Approved by AICTE, New Delhi & Affiliated to JNTUH, Hyderabad.  
Kondapur (V), Ghatkesar (M), Medchal - Makajiri (D) - 501 301 Phone: +91 96529 10002/3



## DEPARTMENT OF ELECTRONICS AND COMMUNICATION ENGINEERING

ADD ON COURSE NAME: **Challenges in Design of PSOCs**

DAY WISE ATTENDANCE SHEET

Academic Year : 2021-2022

Date : 09-03-2022

B.Tech IV-II SEM

SECTION : ECE-A

S.No	Roll Number	09-03-22	10-03-22	11-03-22	12-03-22	13-03-22
1	18UPIA0401	A.Dharani	A.Dharani	A.Dharani	A.Dharani	A.Dharani
2	18UPIA0402	Srilasya	Srilasya	Srilasya	Srilasya	Srilasya
3	18UPIA0403	MOONIKA	MOONIKA	MOONIKA	MOONIKA	MOONIKA
4	18UPIA0404	MOONIKA	MOONIKA	MOONIKA	MOONIKA	MOONIKA
5	18UPIA0405	Ravi	Ravi	Ravi	Ravi	Ravi
6	18UPIA0406	Ravi	Ravi	Ravi	Ravi	Ravi
7	18UPIA0407	Sowjanya	Sowjanya	Sowjanya	Sowjanya	Sowjanya
8	18UPIA0408	Sowjanya	Sowjanya	Sowjanya	Sowjanya	Sowjanya
9	18UPIA0409	Sruvitha	Sruvitha	Sruvitha	Sruvitha	Sruvitha
10	18UPIA0410	G	G	G	G	G
11	18UPIA0412	Gagantha	Gagantha	Gagantha	Gagantha	Gagantha
12	18UPIA0413	G.Kavya	G.Kavya	G.Kavya	G.Kavya	G.Kavya
13	18UPIA0414	G.Mounika	G.Mounika	G.Mounika	G.Mounika	G.Mounika
14	18UPIA0415	G.Divya	G.Divya	G.Divya	G.Divya	G.Divya
15	18UPIA0418	G.Sudha	G.Sudha	G.Sudha	G.Sudha	G.Sudha
16	18UPIA0419	Sharanya	Sharanya	Sharanya	Sharanya	Sharanya
17	18UPIA0420	Sri Vidhya	Sri Vidhya	Sri Vidhya	Sri Vidhya	Sri Vidhya
18	18UPIA0421	Archana	Archana	Archana	Archana	Archana
19	18UPIA0422	Deepthi	Deepthi	Deepthi	Deepthi	Deepthi
20	18UPIA0423	Jhansi	Jhansi	Jhansi	Jhansi	Jhansi
21	18UPIA0424	Jhansi	Jhansi	Jhansi	Jhansi	Jhansi
22	18UPIA0425	Jhansi	Jhansi	Jhansi	Jhansi	Jhansi
23	18UPIA0427	Sudha	Sudha	Sudha	Sudha	Sudha
24	18UPIA0428	K.SONY	K.SONY	K.SONY	K.SONY	K.SONY
25	18UPIA0429	K.Akhila	K.Akhila	K.Akhila	K.Akhila	K.Akhila
26	18UPIA0430	Deepika	Deepika	Deepika	Deepika	Deepika
27	18UPIA0431	Parvati	Parvati	Parvati	Parvati	Parvati
28	18UPIA0432	Sri Vidhya	Sri Vidhya	Sri Vidhya	Sri Vidhya	Sri Vidhya



*[Signature]*

PRINCIPAL

Vignans Institute of Management & Technology for Women  
Kondapur(V), Ghatkesar(M), Medchal-Makajiri(D)-501301

Telangana State

29	18UP1A0433	Mounika	Mounika	Mounika	Mounika	Mounika	Mounika
30	18UP1A0434	Aditi	Aditi	Aditi	Aditi	Aditi	Aditi
31	18UP1A0436	Kusuma	Kusuma	Kusuma	Kusuma	Kusuma	Kusuma
32	18UP1A0437	Miy	Miy	Miy	Miy	Miy	Miy
33	18UP1A0438	Gayathri	Gayathri	Gayathri	Gayathri	Gayathri	Gayathri
34	18UP1A0439						
35	18UP1A0442	Aishwarya	Aishwarya	Aishwarya	Aishwarya	Aishwarya	Aishwarya
36	18UP1A0443	Varshitha	Varshitha	Varshitha	Varshitha	Varshitha	Varshitha
37	18UP1A0444	Jahat	Jahat	Jahat	Jahat	Jahat	Jahat
38	18UP1A0445	Pooja	Pooja	Pooja	Pooja	Pooja	Pooja
39	18UP1A0446	Zeenath	Zeenath	Zeenath	Zeenath	Zeenath	Zeenath
40	18UP1A0447	Aishwarya	Aishwarya	Aishwarya	Aishwarya	Aishwarya	Aishwarya
41	18UP1A0448	Shasanka	Shasanka	Shasanka	Shasanka	Shasanka	Shasanka
42	18UP1A0449	Prasanna	Prasanna	Prasanna	Prasanna	Prasanna	Prasanna
43	18UP1A0450	Nilakshi	Nilakshi	Nilakshi	Nilakshi	Nilakshi	Nilakshi
44	18UP1A0451	Manasa	Manasa	Manasa	Manasa	Manasa	Manasa
45	18UP1A0452	Sreelakshmi	Sreelakshmi	Sreelakshmi	Sreelakshmi	Sreelakshmi	Sreelakshmi
46	18UP1A0453	Sriavani	Sriavani	Sriavani	Sriavani	Sriavani	Sriavani
47	19UP5A0402	Shravan	Shravan	Shravan	Shravan	Shravan	Shravan
48	19UP5A0403	Shravan	Shravan	Shravan	Shravan	Shravan	Shravan
49	19UP5A0404	Niveditha	Niveditha	Niveditha	Niveditha	Niveditha	Niveditha
50	19UP5A0407	Shailaja	Shailaja	Shailaja	Shailaja	Shailaja	Shailaja

  
COORDINATOR

  
HOD

Head of the Department  
Electronics and Communication Engineering  
Vignana's Institute of Management & Technology For Women  
Kondapur (V), Ghatkesar (M), Medchal-Malkajgiri (DR)-501301



  
PRINCIPAL

Vignana's Institute of Management & Technology For Women  
Kondapur (V), Ghatkesar (M), Medchal-Malkajgiri (DR)-501301  
Telangana State



# VIGNAN'S INSTITUTE OF MANAGEMENT AND TECHNOLOGY FOR WOMEN

Sponsored by Laxmi Educational Society, Approved by AICTE, New Delhi & Affiliated to JNTUH, Hyderabad.  
Kondapur (V), Ghatkesar (M), Medchal - Malkajgiri (D) - 501 301 Phone: +91 96529 10002/3



## DEPARTMENT OF ELECTRONICS AND COMMUNICATION ENGINEERING

ADD ON COURSE NAME: Challenges in Design of PSOCs

DAY WISE ATTENDANCE SHEET

Academic Year : 2021-2022

Date : 09-03-2022

B.Tech IV-II SEM

SECTION : ECE-B

S.No	Roll Number	09-03-22	10-03-22	11-03-22	12-03-22	13-03-22
1	18UPIA0454	Present	Present	Present	Present	Present
2	18UPIA0455	Present	Present	Present	Present	Present
3	18UPIA0456	Present	Present	Present	Present	Present
4	18UPIA0457	Saishrutha	Saishrutha	Saishrutha	Saishrutha	Saishrutha
5	18UPIA0458	Saishrutha	Saishrutha	Saishrutha	Saishrutha	Saishrutha
6	18UPIA0459	Abhigna	Abhigna	Abhigna	Abhigna	Abhigna
7	18UPIA0460	Venkata	Venkata	Venkata	Venkata	Venkata
8	18UPIA0461	Lakshmi	Lakshmi	Lakshmi	Lakshmi	Lakshmi
9	18UPIA0462	Kavya	Kavya	Kavya	Kavya	Kavya
10	18UPIA0464	Teja	Teja	Teja	Teja	Teja
11	18UPIA0465	Wanya	Wanya	Wanya	Wanya	Wanya
12	18UPIA0466	G.Lakshmi	G.Lakshmi	G.Lakshmi	G.Lakshmi	G.Lakshmi
13	18UPIA0467	G.Sravanthi	G.Sravanthi	G.Sravanthi	G.Sravanthi	G.Sravanthi
14	18UPIA0468	Deep	Deep	Deep	Deep	Deep
15	18UPIA0469	Keerthi	Keerthi	Keerthi	Keerthi	Keerthi
16	18UPIA0471	Preraj	Preraj	Preraj	Preraj	Preraj
17	18UPIA0472	Divya	Divya	Divya	Divya	Divya
18	18UPIA0473	Rupa	Rupa	Rupa	Rupa	Rupa
19	18UPIA0475	K.Bhavana	K.Bhavana	K.Bhavana	K.Bhavana	K.Bhavana
20	18UPIA0476	Su	Su	Su	Su	Su
21	18UPIA0477	Sath	Sath	Sath	Sath	Sath
22	18UPIA0478	Shrestha	Shrestha	Shrestha	Shrestha	Shrestha
23	18UPIA0479	At	At	At	At	At
24	18UPIA0480	Vasanthi	Vasanthi	Vasanthi	Vasanthi	Vasanthi
25	18UPIA0481	Rakshmi	Rakshmi	Rakshmi	Rakshmi	Rakshmi
26	18UPIA0482	Varshitha	Varshitha	Varshitha	Varshitha	Varshitha
27	18UPIA0484	Su	Su	Su	Su	Su
28	18UPIA0486	Varshitha	Varshitha	Varshitha	Varshitha	Varshitha
29	18UPIA0487	Varshitha	Varshitha	Varshitha	Varshitha	Varshitha



*ASH*  
PRINCIPAL

Vignani's Institute of Management & Technology For Women  
Kondapur(V), Ghatkesar(M), Medchal-Malkajgiri(D)-501301  
Telangana State

30	18UPIA0488	Rmy	Rmy	Rmy	Rmy	Rmy
31	18UPIA0490	P.Bhoomika	P.Bhoomika	P.Bhoomika	P.Bhoomika	P.Bhoomika
32	18UPIA0491	P.Hasini	P.Hasini	P.Hasini	P.Hasini	P.Hasini
33	18UPIA0492	Arvitha	Arvitha	Arvitha	Arvitha	Arvitha
34	18UPIA0493	Madhumitha	Madhumitha	Madhumitha	Madhumitha	Madhumitha
35	18UPIA0495	Pranayali	Pranayali	Pranayali	Pranayali	Pranayali
36	18UPIA0496	-SD	-SD	-SD	-SD	-SD
37	18UPIA0497	NAVYA SRI	NAVYASRI	/	NAVYASRI	NAVYASRI
38	18UPIA0498	Savya	Savya	Savya	Savya	Savya
39	18UPIA0499	Orvitha	Orvitha	Orvitha	Orvitha	Orvitha
40	18UPIA04A0	Madhuri	Madhuri	Madhuri	Madhuri	Madhuri
41	18UPIA04A1	Satvika	Satvika	Satvika	Satvika	Satvika
42	18UPIA04A2	Shreya	Shreya	Shreya	Shreya	Shreya
43	18UPIA04A3	Sushmita	Sushmita	Sushmita	Sushmita	Sushmita
44	19UP5A0408	Renuka	Renuka	Renuka	Renuka	Renuka
45	19UP5A0409	Ilana	Ilana	Ilana	Ilana	Ilana
46	19UP5A0411	Sindhu	Sindhu	Sindhu	Sindhu	Sindhu
47	19UP5A0412	Keerthy	Keerthy	Keerthy	Keerthy	Keerthy
48	19UP5A0413	Akhila	Akhila	Akhila	Akhila	Akhila

  
COORDINATOR

  
HOD

Head of the Department  
Electronics and Communication Engineering  
Vignana's Institute of Management & Technology For Women  
Kondapur (V), Ghatkesar (M), Medchal-Malkajgiri (Dt.)-501301



  
PRINCIPAL

Vignana's Institute of Management & Technology For Women  
Kondapur (V), Ghatkesar (M), Medchal-Malkajgiri (Dt.)-501301  
Telangana State



# VIGNAN'S INSTITUTE OF MANAGEMENT AND TECHNOLOGY FOR WOMEN

Sponsored by Lavu Educational Society, Approved by AICTE, New Delhi & Affiliated to JNTUH, Hyderabad.  
Kondapur (V), Ghatkesar (M), Medchal - Malkajgiri (D) - 501 301 Phone: +91 96529 10002/3



## DEPARTMENT OF ELECTRONICS AND COMMUNICATION ENGINEERING

ADD ON COURSE NAME: **Challenges in Design of PSOCs**

DAY WISE ATTENDANCE SHEET

Academic Year : 2021-2022

Date : 14-03-2022

B.Tech IV-II SEM

SECTION : ECE-A

S.No	Roll Number	14-03-22	15-03-22	16-03-22	19-03-22	21-03-22	22-03-22
1	18UPIA0401	A. Dhara	A. Dhara	A. Dhara	A. Dhara	A. Dhara	A. Dhara
2	18UPIA0402	Srilasya	Srilasya	Srilasya	Srilasya	Srilasya	Srilasya
3	18UPIA0403	VP	VP	VP	VP	VP	VP
4	18UPIA0404	MOUNIKA	MOUNIKA	MOUNIKA	MOUNIKA	MOUNIKA	MOUNIKA
5	18UPIA0405	SL	SL	SL	SL	SL	SL
6	18UPIA0406	Ran	Ran	Ran	Ran	Ran	Ran
7	18UPIA0407	Soumya	Soumya	Soumya	Soumya	Soumya	Soumya
8	18UPIA0408	Soumya	Soumya	Soumya	Soumya	Soumya	Soumya
9	18UPIA0409	Sreetha	Sreetha	Sreetha	Sreetha	Sreetha	Sreetha
10	18UPIA0410	G	G	G	G	G	G
11	18UPIA0412	G. Anuradha	G. Anuradha	G. Anuradha	G. Anuradha	G. Anuradha	G. Anuradha
12	18UPIA0413	G. Kavya	G. Kavya	G. Kavya	G. Kavya	G. Kavya	G. Kavya
13	18UPIA0414	G. Mohana	G. Mohana	G. Mohana	G. Mohana	G. Mohana	G. Mohana
14	18UPIA0415	G. Divya	G. Divya	G. Divya	G. Divya	G. Divya	G. Divya
15	18UPIA0418	G. Sushma	G. Sushma	G. Sushma	G. Sushma	G. Sushma	G. Sushma
16	18UPIA0419	Sharanya	Sharanya	Sharanya	Sharanya	Sharanya	Sharanya
17	18UPIA0420	Sri Vidhya	Sri Vidhya	Sri Vidhya	Sri Vidhya	Sri Vidhya	Sri Vidhya
18	18UPIA0421	Archana	Archana	Archana	Archana	Archana	Archana
19	18UPIA0422	Deepthi	Deepthi	Deepthi	Deepthi	Deepthi	Deepthi
20	18UPIA0423	Flori	Flori	Flori	Flori	Flori	Flori
21	18UPIA0424	Flori	Flori	Flori	Flori	Flori	Flori
22	18UPIA0425	Flori	Flori	Flori	Flori	Flori	Flori
23	18UPIA0427	Sulbi	Sulbi	Sulbi	Sulbi	Sulbi	Sulbi
24	18UPIA0428	K. Sony	K. Sony	K. Sony	K. Sony	K. Sony	K. Sony
25	18UPIA0429	K. Akhila	K. Akhila	K. Akhila	K. Akhila	K. Akhila	K. Akhila
26	18UPIA0430	Deepika	Deepika	Deepika	Deepika	Deepika	Deepika
27	18UPIA0431	Parvati	Parvati	Parvati	Parvati	Parvati	Parvati
28	18UPIA0432	Sri Vidhya	Sri Vidhya	Sri Vidhya	Sri Vidhya	Sri Vidhya	Sri Vidhya



*AS*  
PRINCIPAL

Vignans Institute of Management & Technology for Women  
Kondapur(V), Ghatkesar(M), Medchal-Malkajgiri(D)-501301  
Telangana State

29	18UPIA0433	Mounika.	Mounika.	Mounika.	Mounika.	Mounika.
30	18UPIA0434	Aditi	Aditi	Aditi	Aditi	Aditi
31	18UPIA0436	Kusuma	Kusuma	Kusuma	Kusuma	Kusuma
32	18UPIA0437	May	May	May	May	May
33	18UPIA0438	Gayathri	Gayathri	Gayathri	Gayathri	Gayathri
34	18UPIA0439	Pr	Pr	Pr	Pr	Pr
35	18UPIA0442	AISHWARYA	AISHWARYA	AISHWARYA	AISHWARYA	AISHWARYA
36	18UPIA0443	Valshitha	Valshitha	Valshitha	Valshitha	Valshitha
37	18UPIA0444	Jahat	Jahat	Jahat	Jahat	Jahat
38	18UPIA0445	Pooja	Pooja	Pooja	Pooja	Pooja
39	18UPIA0446	AB	zeenath	zeenath	zeenath	zeenath
40	18UPIA0447	sthanaya	sthanaya	sthanaya	sthanaya	sthanaya
41	18UPIA0448	Sharanya	Sharanya	Sharanya	Sharanya	Sharanya
42	18UPIA0449	AB	AB	AB	AB	AB
43	18UPIA0450	Nilans	Nilans	Nilans	Nilans	Nilans
44	18UPIA0451	Manasa	Manasa	Manasa	Manasa	Manasa
45	18UPIA0452	Sreerja	Sreerja	Sreerja	AB	Sreerja
46	18UPIA0453	Sravani	Sravani	Sravani	Sravani	Sravani
47	19UP5A0402	shirani	shirani	shirani	shirani	shirani
48	19UP5A0403	ilani	ilani	ilani	ilani	ilani
49	19UP5A0404	Niveditha	Niveditha	Niveditha	Niveditha	Niveditha
50	19UP5A0407	shailaja	shailaja	shailaja	shailaja	shailaja

  
COORDINATOR

  
HOD

Head of the Department  
Electronics and Communication Engineering  
Vignaa's Institute of Management & Technology For Women  
Kondapur (V), Ghatkesar (M), Medchal-Malkajgiri (DL)-501301



  
PRINCIPAL  
Vignaa's Institute of Management & Technology For Women  
Kondapur(V),Ghatkesar(M),Medchal-Malkajgiri(DL)-501301  
Telangana State





# VIGNAN'S INSTITUTE OF MANAGEMENT AND TECHNOLOGY FOR WOMEN

Sponsored by Laxmi Educational Society, Approved by AICTE, New Delhi & Affiliated to JNTUH, Hyderabad.  
Kondapur (V), Ghatkesar (M), Medchal - Malkajgiri (D) - 501 301 Phone: +91 96529 10002/3



## DEPARTMENT OF ELECTRONICS AND COMMUNICATION ENGINEERING

ADD ON COURSE NAME: **Challenges in Design of PSOCs**

DAY WISE ATTENDANCE SHEET

Academic Year : 2021-2022

Date : 14-03-2022

B.Tech IV-II SEM

SECTION : ECE-B

S.No	Roll Number	14-03-22	15-03-22	16-03-22	19-03-22	21-03-22	22-03-22
1	18UPIA0454	Int	Int	Int	Int	Int	Int
2	18UPIA0455	Int	Int	Int	Int	Int	Int
3	18UPIA0456	Int	Int	Int	Int	Int	Int
4	18UPIA0457	Saipriya	Saipriya	Saipriya	Saipriya	Saipriya	Saipriya
5	18UPIA0458	Srujalatha	Srujalatha	Srujalatha	Srujalatha	Srujalatha	Srujalatha
6	18UPIA0459	Abhigna	Abhigna	Abhigna	Abhigna	Abhigna	Abhigna
7	18UPIA0460	Venkatesh	Venkatesh	Venkatesh	Venkatesh	Venkatesh	Venkatesh
8	18UPIA0461	Likitha	Likitha	Likitha	Likitha	Likitha	Likitha
9	18UPIA0462	Kavyasree	Kavyasree	Kavyasree	Kavyasree	Kavyasree	Kavyasree
10	18UPIA0464	Teja	Teja	Teja	Teja	Teja	Teja
11	18UPIA0465	Navya	Navya	Navya	Navya	Navya	Navya
12	18UPIA0466	G.Lakshmi	G.Lakshmi	G.Lakshmi	G.Lakshmi	G.Lakshmi	G.Lakshmi
13	18UPIA0467	G.Suvarathi	G.Suvarathi	G.Suvarathi	G.Suvarathi	G.Suvarathi	G.Suvarathi
14	18UPIA0468	Int	Int	Int	Int	Int	Int
15	18UPIA0469	Keerthi	Keerthi	Keerthi	Keerthi	Keerthi	Keerthi
16	18UPIA0471	Reja	Reja	Reja	Reja	Reja	Reja
17	18UPIA0472	Divya	Divya	Divya	Divya	Divya	Divya
18	18UPIA0473	Rupa	Rupa	Rupa	Rupa	Rupa	Rupa
19	18UPIA0475	K. Bhavana	K. Bhavana	K. Bhavana	K. Bhavana	K. Bhavana	K. Bhavana
20	18UPIA0476	Int	Int	Int	Int	Int	Int
21	18UPIA0477	Sath	Sath	Sath	Sath	Sath	Sath
22	18UPIA0478	Shrestha	Shrestha	Shrestha	Shrestha	Shrestha	Shrestha
23	18UPIA0479	Int	Int	Int	Int	Int	Int
24	18UPIA0480	Varshitha	Varshitha	Varshitha	Varshitha	Varshitha	Varshitha
25	18UPIA0481	Lakshmi	Lakshmi	Lakshmi	Lakshmi	Lakshmi	Lakshmi
26	18UPIA0482	Varshitha	Varshitha	Varshitha	Varshitha	Varshitha	Varshitha
27	18UPIA0484	Int	Int	Int	Int	Int	Int
28	18UPIA0486	Int	Int	Int	Int	Int	Int
29	18UPIA0487	Varshitha	Varshitha	Varshitha	Varshitha	Varshitha	Varshitha



*Adh*  
PRINCIPAL

Vignans Institute of Management & Technology For Women  
Kondapur(V), Ghatkesar(M), Medchal-Malkajgiri(D)-501301  
Telangana State

30	18UP1A0488	Amr	Am	Amr	Amr	Amr
31	18UP1A0490	P.Bhoomika	P.Bhoomika	P.Bhoomika	P.Bhoomika	P.Bhoomika
32	18UP1A0491	P.Harini	P.Harini	P.Harini	P.Harini	P.Harini
33	18UP1A0492	Anitha	Anitha	Anitha	Anitha	Anitha
34	18UP1A0493	Madhumitha	Madhumitha	Madhumitha	Madhumitha	Madhumitha
35	18UP1A0495	Pranayali	Pranayali	Pranayali	Pranayali	Pranayali
36	18UP1A0496	-Sp	-Sp	-Sp	-Sp	-Sp
37	18UP1A0497	NAVYASRI	NAVYASRI	NAVYASRI	NAVYASRI	NAVYASRI
38	18UP1A0498	Sravya	Sravya	Sravya	Sravya	Sravya
39	18UP1A0499	Srikrishna	Srikrishna	Srikrishna	Srikrishna	Srikrishna
40	18UP1A04A0	Madhuri	Madhuri	Madhuri	Madhuri	Madhuri
41	18UP1A04A1	Satvika	Satvika	Satvika	Satvika	Satvika
42	18UP1A04A2	Preethi	Preethi	Preethi	Preethi	Preethi
43	18UP1A04A3	Sushmitha	Sushmitha	Sushmitha	Sushmitha	Sushmitha
44	19UP5A0408	Renuka	Renuka	Renuka	Renuka	Renuka
45	19UP5A0409	Shashi	Shashi	Shashi	Shashi	Shashi
46	19UP5A0411	Sindhu	Sindhu	Sindhu	Sindhu	Sindhu
47	19UP5A0412	Keeerthy	Keeerthy	Keeerthy	Am	Keeerthy
48	19UP5A0413	Akhila	Akhila	Akhila	Akhila	Akhila

  
COORDINATOR

  
HOD

Head of the Department  
Electronics and Communication Engineering,  
Vignans Institute of Management & Technology For Women  
Kondapur (V), Ghatkesar (M), Medchal-Malkajgiri (DL)-501301



  
PRINCIPAL

Vignans Institute of Management & Technology For Women  
Kondapur(V), Ghatkesar(M), Medchal-Malkajgiri(DL)-501301  
Telangana State



# VIGNAN'S INSTITUTE OF MANAGEMENT AND TECHNOLOGY FOR WOMEN

Sponsored by Lava Educational Society, Approved by AICTE, New Delhi & Affiliated to JNTUH, Hyderabad.  
Kondapur (V), Ghatkesar (M), Medchal - Malkajgiri (D) - 501 301 Phone: +91 96529 10002/3



## DEPARTMENT OF ELECTRONICS AND COMMUNICATION ENGINEERING

ADD ON COURSE NAME: **Challenges in Design of PSOCs**

DAY WISE ATTENDANCE SHEET

Academic Year : 2021-2022

Date : 23-03-2022

B.Tech IV-II SEM

SECTION : ECE-A

S.No	Roll Number	23-03-22	24-03-22	25-03-22	26-03-22	28-03-22	29-03-22
1	18UPIA0401	A Dharani	A Dharani	A Dharani	A Dharani	A Dharani	A Dharani
2	18UPIA0402	Srilasya	Srilasya	Srilasya	Srilasya	Srilasya	Srilasya
3	18UPIA0403	VP	VP	VP	VP	VP	VP
4	18UPIA0404	MOUNIKS	MOUNIKS	MOUNIKS	MOUNIKS	MOUNIKS	MOUNIKS
5	18UPIA0405	SS	SS	SS	SS	SS	SS
6	18UPIA0406	Ran	Ran	Ran	Ran	Ran	Ran
7	18UPIA0407	Soujanya	Soujanya	Soujanya	Soujanya	Soujanya	Soujanya
8	18UPIA0408	Snehalatha	Snehalatha	Snehalatha	Snehalatha	Snehalatha	Snehalatha
9	18UPIA0409	Snehalatha	Snehalatha	Snehalatha	Snehalatha	Snehalatha	Snehalatha
10	18UPIA0410	Gan	Gan	Gan	Gan	Gan	Gan
11	18UPIA0412	G.Akasha	G.Akasha	G.Akasha	G.Akasha	G.Akasha	G.Akasha
12	18UPIA0413	G.Kavya	G.Kavya	G.Kavya	G.Kavya	G.Kavya	G.Kavya
13	18UPIA0414	G.mounika	G.mounika	G.mounika	G.mounika	G.mounika	G.mounika
14	18UPIA0415	G.Divya	G.Divya	G.Divya	G.Divya	G.Divya	G.Divya
15	18UPIA0418	G.sushma	G.sushma	G.sushma	G.sushma	G.sushma	G.sushma
16	18UPIA0419	Sharanya	Sharanya	Sharanya	Sharanya	Sharanya	Sharanya
17	18UPIA0420	Sai vidhya	Sai vidhya	Sai vidhya	Sai vidhya	Sai vidhya	Sai vidhya
18	18UPIA0421	Atchasa	Atchasa	Atchasa	Atchasa	Atchasa	Atchasa
19	18UPIA0422	Deepthi	Deepthi	Deepthi	Deepthi	Deepthi	Deepthi
20	18UPIA0423	Harini	Harini	Harini	Harini	Harini	Harini
21	18UPIA0424	Harini	Harini	Harini	Harini	Harini	Harini
22	18UPIA0425	Harini	Harini	Harini	Harini	Harini	Harini
23	18UPIA0427	Sneha	Sneha	Sneha	Sneha	Sneha	Sneha
24	18UPIA0428	K.Sony	K.Sony	K.Sony	K.Sony	K.Sony	K.Sony
25	18UPIA0429	K.Akhila	K.Akhila	K.Akhila	K.Akhila	K.Akhila	K.Akhila
26	18UPIA0430	Deepika	Deepika	Deepika	Deepika	Deepika	Deepika
27	18UPIA0431	Parvati	Parvati	Parvati	Parvati	Parvati	Parvati
28	18UPIA0432	Sri Vidya	Sri Vidya	Sri Vidya	Sri Vidya	Sri Vidya	Sri Vidya
29	18UPIA0433	Mounika	Mounika	Mounika	Mounika	Mounika	Mounika



*(Signature)*  
PRINCIPAL

Vignans Institute of Management & Technology For Women  
Kondapur(V), Ghatkesar(M), Medchal-Malkajgiri(D)-501301  
Telangana State

30	18UP1A0434	Aditi	Aditi	Aditi	Aditi	Aditi	Aditi
31	18UP1A0436	Kusuma	Kusuma	Kusuma	Kusuma	Kusuma	Kusuma
32	18UP1A0437	Mej	Mej	Mej	Mej	Mej	Mej
33	18UP1A0438	Gayathri	Gayathri	Gayathri	Gayathri	Gayathri	Gayathri
34	18UP1A0439	JD	JD	JD	JD	JD	JD
35	18UP1A0442	AISHWARYA	AISHWARYA	AISHWARYA	AISHWARYA	AISHWARYA	AISHWARYA
36	18UP1A0443	Varshitha	Varshitha	Varshitha	Varshitha	Varshitha	Varshitha
37	18UP1A0444	Jahat	Jahat	Jahat	Jahat	Jahat	Jahat
38	18UP1A0445	Pooja	Pooja	Pooja	Pooja	Pooja	Pooja
39	18UP1A0446	zeenath	zeenath	zeenath	zeenath	zeenath	zeenath
40	18UP1A0447	Aishwarya	Aishwarya	AB	Aishwarya	Aishwarya	Aishwarya
41	18UP1A0448	sharanga	sharanga	sharanga	sharanga	sharanga	sharanga
42	18UP1A0449	Asit	Asit	Asit	Asit	Asit	Asit
43	18UP1A0450	Mihara	Mihara	Mihara	Mihara	Mihara	Mihara
44	18UP1A0451	Manasa	Manasa	Manasa	Manasa	Manasa	Manasa
45	18UP1A0452	Sreeraj	Sreeraj	Sreeraj	Sreeraj	Sreeraj	Sreeraj
46	18UP1A0453	Saravani	Saravani	Saravani	Saravani	Saravani	Saravani
47	19LPSA0402	shirani	shirani	shirani	shirani	shirani	shirani
48	19LPSA0403	shani	shani	shani	shani	shani	shani
49	19LPSA0404	Niveditha	Niveditha	Niveditha	Niveditha	Niveditha	Niveditha
50	19LPSA0407	shailaja	shailaja	shailaja	shailaja	shailaja	shailaja

  
COORDINATOR

  
HOD

Head of the Department  
Electronics and Communication Engineering  
Vignana's Institute of Management & Technology For Women  
Kondapur (V), Ghatkesar (M), Medchal-Malkajgiri (DL)-501301



  
PRINCIPAL  
Vignana's Institute of Management & Technology For Women  
Kondapur(V), Ghatkesar(M), Medchal-Malkajgiri(DL)-501301  
Telangana State



# VIGNAN'S INSTITUTE OF MANAGEMENT AND TECHNOLOGY FOR WOMEN

Sponsored by Lavu Educational Society, Approved by AICTE, New Delhi & Affiliated to JNTUH, Hyderabad  
Kondapur (V), Ghatkesar (M), Medchal - Malkajgiri (D) - 501 301 Phone: +91 96529 10002/3



## DEPARTMENT OF ELECTRONICS AND COMMUNICATION ENGINEERING

ADD ON COURSE NAME: **Challenges in Design of PSOCs**

DAY WISE ATTENDANCE SHEET

Academic Year : 2021-2022

Date : 23-03-2022

B.Tech IV-II SEM

SECTION : ECE-B

S.No	Roll number	23-03-22	24-03-22	25-03-22	26-03-22	28-03-22	29-03-22
1	18UPIA0454	Sw	Sw	Sw	Sw	Sw	Sw
2	18UPIA0455	Sw	Sw	Sw	Sw	Sw	Sw
3	18UPIA0456	Sw	Sw	Sw	Sw	Sw	Sw
4	18UPIA0457	Sainiya	Sainiya	Sainiya	Sainiya	Sainiya	Sainiya
5	18UPIA0458	Sai Ashwatha	Sai Ashwatha	Sai Ashwatha	Sai Ashwatha	Sai Ashwatha	Sai Ashwatha
6	18UPIA0459	Abhigna	Abhigna	Abhigna	Abhigna	Abhigna	Abhigna
7	18UPIA0460	venkatakalu	venkatakalu	venkatakalu	venkatakalu	venkatakalu	venkatakalu
8	18UPIA0461	Likitha	Likitha	Likitha	Likitha	Likitha	Likitha
9	18UPIA0462	Kavyasree	Kavyasree	Kavyasree	Kavyasree	Kavyasree	Kavyasree
10	18UPIA0464	Teja	Teja	Teja	Teja	Teja	Teja
11	18UPIA0465	Navya	Navya	Navya	Navya	Navya	Navya
12	18UPIA0466	G.Lakshmi	G.Lakshmi	G.Lakshmi	G.Lakshmi	G.Lakshmi	G.Lakshmi
13	18UPIA0467	G.saravathi	G.saravathi	G.saravathi	G.saravathi	G.saravathi	G.saravathi
14	18UPIA0468	Navya	Navya	Navya	Navya	Navya	Navya
15	18UPIA0469	Keerthi	Keerthi	Keerthi	Keerthi	Keerthi	Keerthi
16	18UPIA0471	Pooja	Pooja	Pooja	Pooja	Pooja	Pooja
17	18UPIA0472	Divya	Divya	Divya	Divya	Divya	Divya
18	18UPIA0473	Rupa	Rupa	Rupa	Rupa	Rupa	Rupa
19	18UPIA0475	K.Bhavana	K.Bhavana	K.Bhavana	K.Bhavana	K.Bhavana	K.Bhavana
20	18UPIA0476	Sw	Sw	Sw	Sw	Sw	Sw
21	18UPIA0477	Sath	Sath	Sath	Sath	Sath	Sath
22	18UPIA0478	shaesta	shaesta	shaesta	shaesta	shaesta	shaesta
23	18UPIA0479	Sw	Sw	Sw	Sw	Sw	Sw
24	18UPIA0480	Sw	Sw	Sw	Sw	Sw	Sw
25	18UPIA0481	Lakshmi	Lakshmi	Lakshmi	Lakshmi	Lakshmi	Lakshmi
26	18UPIA0482	Varshitha	Varshitha	Varshitha	Varshitha	Varshitha	Varshitha
27	18UPIA0484	Sw	Sw	Sw	Sw	Sw	Sw
28	18UPIA0486	Sw	Sw	Sw	Sw	Sw	Sw
29	18UPIA0487	Varshitha	Varshitha	Varshitha	Varshitha	Varshitha	Varshitha



**ASH**  
PRINCIPAL

Vignans Institute of Management & Technology For Women  
Kondapur(V), Ghatkesar(M), Medchal-Malkajgiri(D)-501301  
Telangana State

30	18UP1A0488	Raj	Raj	Raj	Raj	Raj	Raj
31	18UP1A0490	P.Bhoonika	P.Bhoonika	P.Bhoonika	P.Bhoonika	P.Bhoonika	P.Bhoonika
32	18UP1A0491	P.Hasini	P.Hasini	P.Hasini	P.Hasini	P.Hasini	P.Hasini
33	18UP1A0492	Anitha	Anitha	Anitha	Anitha	Anitha	Anitha
34	18UP1A0493	Madhumitha	Madhumitha	Madhumitha	Madhumitha	Madhumitha	Madhumitha
35	18UP1A0495	Pranayali	Pranayali	Pranayali	Pranayali	Pranayali	Pranayali
36	18UP1A0496	-SD	-SD	-SD	-SD	-SD	-SD
37	18UP1A0497	NAVYASRI	NAVYASRI	NAVYASRI	NAVYASRI	NAVYASRI	NAVYASRI
38	18UP1A0498	Sravya	Sravya	Sravya	Sravya	Sravya	Sravya
39	18UP1A0499	Srinthu	Srinthu	Srinthu	Srinthu	Srinthu	Srinthu
40	18UP1A04A0	Madhuri	Madhuri	Madhuri	Madhuri	AB	Madhuri
41	18UP1A04A1	Satvika	Satvika	Satvika	Satvika	Satvika	Satvika
42	18UP1A04A2	Shreya	Shreya	Shreya	Shreya	Shreya	Shreya
43	18UP1A04A3	Sushmita	Sushmita	Sushmita	Sushmita	Sushmita	Sushmita
44	19UP5A0408	Renuka	Renuka	Renuka	Renuka	Renuka	Renuka
45	19UP5A0409	Shani	Shani	Shani	Shani	Shani	Shani
46	19UP5A0411	Sindhu	Sindhu	Sindhu	Sindhu	Sindhu	Sindhu
47	19UP5A0412	Keerthy	Keerthy	Keerthy	Keerthy	Keerthy	Keerthy
48	19UP5A0413	Akhila	Akhila	Akhila	Akhila	Akhila	Akhila

  
COORDINATOR

  
HOD

Head of the Department  
Electronics and Communication Engineering  
Vignana's Institute of Management & Technology For Women  
Kondapur (V), Ghatkesar (M), Medchal-Malkajgiri (Dt)-501301



  
PRINCIPAL

Vignana's Institute of Management & Technology For Women  
Kondapur (V), Ghatkesar (M), Medchal-Malkajgiri (Dt)-501301  
Telangana State



# VIGNAN'S INSTITUTE OF MANAGEMENT AND TECHNOLOGY FOR WOMEN

Sponsored by Lawu Educational Society, Approved by AICTE, New Delhi & Affiliated to JNTUH, Hyderabad.  
Kondapur (V), Ghatkesar (M), Medchal - Malkajgiri (D) - 501 301 Phone: +91 96529 10002/3



## DEPARTMENT OF ELECTRONICS AND COMMUNICATION ENGINEERING

ADD ON COURSE NAME: **Challenges in Design of PSOCs**

DAY WISE ATTENDANCE SHEET

Academic Year : 2021-2022

Date : 30-03-2022

B.Tech IV-II SEM

SECTION : ECE-A

S.No	Roll Number	30-03-22	31-03-22	01-04-22	02-04-22	04-04-22	05-04-22
1	18UPIA0401	A.Dharani	A.Dharani	A.Dharani	A.Dharani	A.Dharani	A.Dharani
2	18UPIA0402	Srilakshya	Srilakshya	Srilakshya	Srilakshya	Srilakshya	Srilakshya
3	18UPIA0403	mp	mp	mp	mp	mp	mp
4	18UPIA0404	MOUNIKA	MOUNIKA	MOUNIKA	MOUNIKA	MOUNIKA	MOUNIKA
5	18UPIA0405	sd	sd	sd	sd	sd	sd
6	18UPIA0406	Ran	Ran	Ran	Ran	Ran	Ran
7	18UPIA0407	Soujanya	Soujanya	Soujanya	Soujanya	Soujanya	Soujanya
8	18UPIA0408	shivani	shivani	shivani	shivani	shivani	shivani
9	18UPIA0409	sruthika	sruthika	sruthika	sruthika	sruthika	sruthika
10	18UPIA0410	an	an	an	an	an	an
11	18UPIA0412	G.Akshara	G.Akshara	G.Akshara	G.Akshara	G.Akshara	G.Akshara
12	18UPIA0413	G.Kavya	G.Kavya	G.Kavya	G.Kavya	G.Kavya	G.Kavya
13	18UPIA0414	G.Mounika	G.Mounika	G.Mounika	G.Mounika	G.Mounika	G.Mounika
14	18UPIA0415	G.Divya	G.Divya	G.Divya	G.Divya	G.Divya	G.Divya
15	18UPIA0418	G.Sushma	G.Sushma	G.Sushma	G.Sushma	G.Sushma	G.Sushma
16	18UPIA0419	Shravya	Shravya	Shravya	Shravya	Shravya	Shravya
17	18UPIA0420	Sei Vidhya	Sei Vidhya	Sei Vidhya	Sei Vidhya	Sei Vidhya	Sei Vidhya
18	18UPIA0421	Akshara	Akshara	Akshara	Akshara	Akshara	Akshara
19	18UPIA0422	Deepthi	Deepthi	Deepthi	Deepthi	Deepthi	Deepthi
20	18UPIA0423	Harini	Harini	Harini	Harini	Harini	Harini
21	18UPIA0424	sd	sd	sd	sd	sd	sd
22	18UPIA0425	Harini	Harini	Harini	Harini	Harini	Harini
23	18UPIA0427	Sushma	Sushma	Sushma	Sushma	Sushma	Sushma
24	18UPIA0428	K.SONY	K.SONY	K.SONY	K.SONY	K.SONY	K.SONY
25	18UPIA0429	K.Akhila	K.Akhila	K.Akhila	K.Akhila	K.Akhila	K.Akhila
26	18UPIA0430	Deepika	Deepika	Deepika	Deepika	Deepika	Deepika
27	18UPIA0431	Pavani	Pavani	Pavani	Pavani	Pavani	Pavani
28	18UPIA0432	Sri Vidya	Sri Vidya	Sri Vidya	Sri Vidya	Sri Vidya	Sri Vidya
29	18UPIA0433	Mounika	Mounika	Mounika	Mounika	Mounika	Mounika



**PRINCIPAL**

Vignans Institute of Management & Technology For Women  
Kondapur(V), Ghatkesar(M), Medchal-Malkajgiri(D)-501301  
Telangana State

30	18UPIA0434	Aditi	Aditi	Aditi	Aditi	Aditi	Aditi
31	18UPIA0436	Kusuma	Kusuma	Kusuma	Kusuma	Kusuma	Kusuma
32	18UPIA0437	Gayathri	Gayathri	Gayathri	Gayathri	Gayathri	Gayathri
33	18UPIA0438	Gayathri	Gayathri	Gayathri	Gayathri	Gayathri	Gayathri
34	18UPIA0439	Raj	Raj	Raj	Raj	Raj	Raj
35	18UPIA0442	AISHWARYA	AISHWARYA	AISHWARYA	AISHWARYA	AISHWARYA	AISHWARYA
36	18UPIA0443	Vaishitka	Vaishitka	Vaishitka	Vaishitka	Vaishitka	Vaishitka
37	18UPIA0444	Jahat	Jahat	Jahat	Jahat	Jahat	Jahat
38	18UPIA0445	preja	preja	preja	preja	preja	preja
39	18UPIA0446	zeenath	zeenath	zeenath	zeenath	zeenath	zeenath
40	18UPIA0447	shikanya	shikanya	shikanya	shikanya	shikanya	shikanya
41	18UPIA0448	sharanya	sharanya	sharanya	sharanya	sharanya	sharanya
42	18UPIA0449	Asit	Asit	Asit	Asit	Asit	Asit
43	18UPIA0450	Niharika	Niharika	Niharika	Niharika	Niharika	Niharika
44	18UPIA0451	Manasa	Manasa	Manasa	Manasa	Manasa	Manasa
45	18UPIA0452	Sreeraj	Sreeraj	Sreeraj	Sreeraj	Sreeraj	Sreeraj
46	18UPIA0453	Sravani	Sravani	Sravani	Sravani	Sravani	Sravani
47	19UPS A0402	shirani	shirani	shirani	shirani	shirani	shirani
48	19UPS A0403	shani	shani	shani	shani	shani	shani
49	19UPS A0404	Niveditha	Niveditha	Niveditha	Niveditha	Niveditha	Niveditha
50	19UPS A0407	shailaja	shailaja	shailaja	shailaja	shailaja	shailaja

  
COORDINATOR

  
HOD

Head of the Department  
Electronics and Communication Engineering  
Women's Institute of Management & Technology For Women  
Kondapur (V), Ghatkesar (M), Medchal-Malkajgiri (Dt)-501301



  
PRINCIPAL

Women's Institute of Management & Technology For Women  
Kondapur (V), Ghatkesar (M), Medchal-Malkajgiri (Dt)-501301  
Telangana State





# VIGNAN'S INSTITUTE OF MANAGEMENT AND TECHNOLOGY FOR WOMEN

Sponsored by Law Educational Society, Approved by AICTE, New Delhi & Affiliated to JNTUH, Hyderabad.  
Kondapur (V), Ghatkesar (M), Medchal - Malkajgiri (D) - 501 301 Phone: +91 96529 10002/3



## DEPARTMENT OF ELECTRONICS AND COMMUNICATION ENGINEERING

ADD ON COURSE NAME: **Challenges in Design of PSOCs**

DAY WISE ATTENDANCE SHEET

Academic Year : 2021-2022

Date : 30-03-2022

B.Tech IV-II SEM

SECTION : ECE-B

S.No	Roll Number	30-03-22	31-03-22	01-04-22	02-04-22	04-04-22	05-04-22
1	18UPIA0454	Just	Just	Just	Just	Just	Just
2	18UPIA0455	Just	Just	Just	Just	Just	Just
3	18UPIA0456	Just	Just	Just	Just	Just	Just
4	18UPIA0457	Saipriya	Saipriya	Saipriya	Saipriya	Saipriya	Saipriya
5	18UPIA0458	Sai Ashwika	Sai Ashwika	Sai Ashwika	Sai Ashwika	Sai Ashwika	Sai Ashwika
6	18UPIA0459	Abhigna	Abhigna	Abhigna	Abhigna	Abhigna	Abhigna
7	18UPIA0460	Venkata Key	Venkata Key	Venkata Key	Venkata Key	Venkata Key	Venkata Key
8	18UPIA0461	Likitha	Likitha	Likitha	Likitha	Likitha	Likitha
9	18UPIA0462	Kavyasree	Kavyasree	Kavyasree	Kavyasree	Kavyasree	Kavyasree
10	18UPIA0464	Teja	Teja	Teja	Teja	Teja	Teja
11	18UPIA0465	Navya	Navya	Navya	Navya	Navya	Navya
12	18UPIA0466	G.Lakshmi	G.Lakshmi	G.Lakshmi	G.Lakshmi	G.Lakshmi	G.Lakshmi
13	18UPIA0467	G.Sravathi	G.Sravathi	G.Sravathi	G.Sravathi	G.Sravathi	G.Sravathi
14	18UPIA0468	Just	Just	Just	Just	Just	Just
15	18UPIA0469	Keerthi	Keerthi	Keerthi	Keerthi	Keerthi	Keerthi
16	18UPIA0471	Pooja	Pooja	Pooja	Pooja	Pooja	Pooja
17	18UPIA0472	Durga	Durga	Durga	Durga	Durga	Durga
18	18UPIA0473	Rupa	Rupa	Rupa	Rupa	Rupa	Rupa
19	18UPIA0475	K.Bhavana	K.Bhavana	K.Bhavana	K.Bhavana	K.Bhavana	K.Bhavana
20	18UPIA0476	Just	Just	Just	Just	Just	Just
21	18UPIA0477	Sath	Sath	Sath	Sath	Sath	Sath
22	18UPIA0478	Shaesta	Shaesta	Shaesta	Shaesta	Shaesta	Shaesta
23	18UPIA0479	Just	Just	Just	Just	Just	Just
24	18UPIA0480	Just	Just	Just	Just	Just	Just
25	18UPIA0481	Lakshmi	Lakshmi	Lakshmi	Lakshmi	Lakshmi	Lakshmi
26	18UPIA0482	Varshitha	Varshitha	Varshitha	Varshitha	Varshitha	Varshitha
27	18UPIA0484	Just	Just	Just	Just	Just	Just
28	18UPIA0486	Just	Just	Just	Just	Just	Just
29	18UPIA0487	Varshitha	Varshitha	Varshitha	Varshitha	Varshitha	Varshitha



**ASH**  
PRINCIPAL

Vignans Institute of Management & Technology For Women  
Kondapur(V), Ghatkesar(M), Medchal - Malkajgiri(D) - 501301  
Telangana State

30	18UPIA0488	Rut	Rut	Rut	Rut	Rut	Rut
31	18UPIA0490	P.Bhoomika	P.Bhoomika	P.Bhoomika	P.Bhoomika	P.Bhoomika	P.Bhoomika
32	18UPIA0491	P.Hasiya	P.Hasiya	P.Hasiya	P.Hasiya	P.Hasiya	P.Hasiya
33	18UPIA0492	Anitha	Anitha	Anitha	Anitha	Anitha	Anitha
34	18UPIA0493	Madhusita	Madhusita	Madhusita	Madhusita	Madhusita	Madhusita
35	18UPIA0495	Pranayali	Pranayali	Pranayali	Pranayali	Pranayali	Pranayali
36	18UPIA0496	-Sp	-Sp	-Sp	-Sp	-Sp	-Sp
37	18UPIA0497	NAVYASRI	NAVYASRI	NAVYASRI	NAVYASRI	NAVYASRI	NAVYASRI
38	18UPIA0498	Swanya	Swanya	Swanya	Swanya	Swanya	Swanya
39	18UPIA0499	Srinthu	Srinthu	Srinthu	Srinthu	Srinthu	Srinthu
40	18UPIA04A0	Madhusi	Madhusi	Madhusi	Madhusi	Madhusi	Madhusi
41	18UPIA04A1	Satvika	Satvika	Satvika	Satvika	Satvika	Satvika
42	18UPIA04A2	Seerja	Seerja	Seerja	Seerja	Seerja	Seerja
43	18UPIA04A3	Sushmita	Sushmita	Sushmita	Sushmita	Sushmita	Sushmita
44	19UP5A0408	Renuka	Renuka	Renuka	Renuka	Renuka	Renuka
45	19UP5A0409	Janet	Janet	Janet	Janet	Janet	Janet
46	19UP5A0411	Jindhu	Jindhu	Jindhu	Jindhu	Jindhu	Jindhu
47	19UP5A0412	Keerthy	Keerthy	Keerthy	Keerthy	Keerthy	Keerthy
48	19UP5A0413	Akhila	Akhila	Akhila	Akhila	Akhila	Akhila

COORDINATOR

HOD

Head of the Department  
Electronics and Communication Engineering  
Vignar's Institute of Management & Technology For Women  
Kondapur (V), Ghatkesar (M), Medchal-Malkajgiri (Dt.)-501301



PRINCIPAL

Vignar's Institute of Management & Technology For Women  
Kondapur(V),Ghatkesar(M),Medchal-Malkajgiri(Dt.)-501301  
Telangana State



**DEPARTMENT OF ELECTRONICS AND COMMUNICATION ENGINEERING**

Date: 08-04-2022

**PROGRAM REPORT**

**Name of the Add on Course:** Challenges in Design of PSOCs

**Day/Duration:** 33 hours

**Time:** 4:00pm to 5:00pm

**Resource Person:** Mr. Ranveer Singh, True chip Pvt.Ltd. Hyderabad

**Name of the Coordinator:** Mr.J.SunilKumar, Assistant Professor, VMTW, Hyderabad.

**Number of the Participants:** 98

**Topics covered:** The following topics covered in this program

- SOC
- PSOC

**Course Outcomes:**

COs	At the end of the course, students will have the ability to:	POs Mapped	Strength of mapping
CO1	Learn the Basic concepts in Processor Architecture	PO2, PO5	3
CO2	Analyze the memory design for SOC	PO3 , PO4	2
CO3	Understand the memory design for SOC and overview of SOC external memory	PO2, PO3,PO6	1
CO4	Analyze the Interconnect Customization	PO5 , PO7	2

**Assessment Procedure:** The assessment of the Add on course is conducted in Multiple Choice Questions through offline Mode.

  
**COORDINATOR**  
Vignans Institute of Management & Technology  
Kondapur (V), Ghatkesar (M), Medchal - Malkajgiri (D) - 501 301, T.S.

  
**PRINCIPAL**  
Vignans Institute of Management & Technology For Women  
Kondapur(V),Ghatkesar(M),Medchal-Malkajgiri(D)-501301  
Telangana State

  
**HOD**  
Head of the Department  
Electronics and Communication Engineering  
Vignans Institute of Management & Technology For Women  
Kondapur (V), Ghatkesar (M), Medchal-Malkajgiri (D)-501301



# VIGNAN'S INSTITUTE OF MANAGEMENT AND TECHNOLOGY FOR WOMEN

(Sponsored by Lavu Educational Society)

Approved by AICTE, New Delhi & Affiliated to JNTUH, Hyderabad.

Kondapur (V), Ghatkesar (M), Medchal - Malkajgiri (D) - 501 301



## CERTIFICATE OF COURSE COMPLETION

*This certificate is presented to*

JAKKA DEEPTHI

*for her completion of an Add-on course on*

**“CHALLENGES IN DESIGN OF PSOCs” held from 24<sup>TH</sup> FEBRUARY to 5<sup>TH</sup> APRIL, 2022,**

*Organized by the Department of Electronics and Communication Engineering,*

*In association with Truechip , Noida.*

  
Co-ordinator



  
HoD, ECE

  
PRINCIPAL  
Vignans Institute of Management & Technology For Women  
Kondapur(V), Ghatkesar(M), Medchal-Malkajgiri(D)-501301  
Telangana State

  
Principal, VMTW  
PRINCIPAL

Vignans Institute of Management & Technology For Women  
Kondapur(V), Ghatkesar(M), Medchal-Malkajgiri(D)-501301  
Telangana State



# VIGNAN'S INSTITUTE OF MANAGEMENT AND TECHNOLOGY FOR WOMEN

Sponsored by Lavu Educational Society, Approved by AICTE, New Delhi & Affiliated to JNTUH, Hyderabad.  
Kondapur (V), Ghatkesar (M), Medchal - Malkajgiri (D) - 501 301 Phone: +91 96529 10002/3



## DEPARTMENT OF ELECTRONICS AND COMMUNICATION ENGINEERING

VMTW/ECE/AOC/CIR/2021-22/I/03

Date: 08-09-2021.

### CIRCULAR

This is to inform all the IV B.Tech ECE students that there will be an Add on course on " **Modern Chip Design and Its Applications** " in association with True chip Pvt Ltd. from **13-09-2021 to 30-10-2021** All students are invited to take part in this course. The participating students will be honored with certificates of participation. During the course you will be encouraged to interact with the speaker and the other participants through the case study discussions. Hence those who are interested can sign in registration form.

HOD

Head of the Department

Electronics & Communication Engineering  
Vignani Institute of Management & Technology for Women  
Kondapur (V), Ghatkesar (M), Medchal - Malkajgiri (D) - 501 301

Copy to

The Principal, for kind information

IQAC

Notice board

II.B. Tech students

Dept. file



PRINCIPAL

Vignani Institute of Management & Technology For Women  
Kondapur(V),Ghatkesar(M),Medchal-Malkajgiri(D)-501301  
Telangana State

## ABOUT THE COURSE

Introduction to IC Technology – MOS, PMOS, NMOS, CMOS & BiCMOS Basic Electrical Properties: Basic Electrical Properties of MOS and BiCMOS Circuits VLSI Circuit Design Processes: VLSI Design Flow, MOS Layers, Stick Diagrams, Design Rules and Layout, Transistors Layout Diagrams for NMOS and CMOS Inverters and Gates, Scaling of MOS circuits Gate Level Design: Logic Gates and Other complex gates, Switch logic. Data Path Subsystems Programmable Logic Devices: Design Approach – PLA, PAL, Standard Cells FPGAs, CPLDs. CMOS.

## COURSE OBJECTIVES

The objectives of the course are to: Give exposure to different steps involved in the fabrication of ICs. Explain the electrical properties of MOS and BiCMOS devices to analyze the behavior of inverters designed with various loads. Give exposure to the design rules to be followed to draw the layout of any logic circuit. Provide design concepts to design building blocks of the data path of any system using gates. Understand basic programmable logic devices and testing of CMOS circuits.

## EXPECTED OUTCOMES

The student will be able to. Acquire qualitative knowledge about the fabrication process of integrated circuits using MOS transistors. 2. Draw the layout of any logic circuit which helps to understand and estimate the parasitic effect of any logic circuit. Design building blocks of data path systems, memories, and simple logic circuits using PLA, PAL, FPGA, and CPLD. Understand different types of faults that can occur in a system and learn the concept of testing and adding extra hardware to improve the testability of the system



Resource Person:  
**Mr. Ranveer Singh,**  
Technical Manager,  
Truechip, Noida

Co-ordinator:  
**Mr. T. Pullaiah,**  
Associate Professor,  
Department of ECE,  
Contact No: +91 96425 64980

LAST DATE FOR REGISTRATION: 10<sup>TH</sup> SEPTEMBER, 2021



(Sponsored by Lavu Educational Society)  
Approved by AICTE, New Delhi & Affiliated to JNTUH, Hyderabad.  
Kondapur (V), Ghatkesar (M), Medchal - Malkajgiri (D) - 501 301

ADD-ON COURSE ON  
**“MODERN CHIP DESIGN  
AND ITS APPLICATIONS”**  
13<sup>TH</sup> SEP TO 30<sup>TH</sup> OCT, 2021

IN ASSOCIATION WITH:



DURATION OF THE COURSE : **32 HRS**

VENUE:

**'B'-BLOCK SEMINAR HALL, VMTW**

PRINCIPAL

Vignan's Institute of Management & Technology For Women  
Kondapur(V), Ghatkesar(M), Medchal-Malkajgiri(Dt)-501301  
Telangana

ORGANIZED BY:

**DEPARTMENT OF ELECTRONICS AND  
COMMUNICATION ENGINEERING**





# VIGNAN'S INSTITUTE OF MANAGEMENT AND TECHNOLOGY FOR WOMEN

Sponsored by Lavu Educational Society, Approved by AICTE, New Delhi & Affiliated to JNTUH, Hyderabad.  
Kondapur (V), Ghatkesar (M), Medchal - Malkajgiri (D) - 501 301 Phone: +91 96529 10002/3



## DEPARTMENT OF ELECTRONICS AND COMMUNICATION ENGINEERING

ADD ON COURSE NAME: **Modern Chip Design and Its Applications**

DAY WISE SCHEDULE SHEET

Academic Year : 2021-2022

Date : 07-09-2021

B.Tech IV-I SEM

SECTION : ECE-A & B

Room number: BFF5

S.No	DAY	Topic	Timings	Duration
1.	13-09-21	Introduction to IC Technology	04:00pm to 05:00pm	1 hour
2.	14-09-21	MOS, PMOS, NMOS, CMOS &	04:00pm to 05:00pm	1 hour
3.	15-09-21	Basic Electrical Properties	04:00pm to 05:00pm	1 hour
4.	16-09-21	Basic Electrical Properties of MOS and	04:00pm to 05:00pm	1 hour
5.	17-09-21	Basic Electrical Properties of MOS and	04:00pm to 05:00pm	1 hour
6.	18-09-21	Ids-Vds relationships	04:00pm to 05:00pm	1 hour
7.	20-09-21	MOS transistor threshold Voltage, gm,	04:00pm to 05:00pm	1 hour
8.	21-09-21	Figure of merit; Pass transistor	04:00pm to 05:00pm	1 hour
9.	22-09-21	NMOS Inverter	04:00pm to 05:00pm	1 hour
10.	23-09-21	Various pull ups	04:00pm to 05:00pm	1 hour
11.	24-09-21	CMOS Inverter analysis and design	04:00pm to 05:00pm	1 hour
12.	25-09-21	Bi-CMOS Inverters.	04:00pm to 05:00pm	1 hour
13.	27-09-21	VLSI Circuit Design Processes	04:00pm to 05:00pm	1 hour
14.	28-09-21	VLSI Design Flow	04:00pm to 05:00pm	1 hour
15.	29-09-21	MOS Layers	04:00pm to 05:00pm	1 hour
16.	30-09-21	Stick Diagrams	04:00pm to 05:00pm	1 hour
17.	01-10-21	Design Rules and Layout	04:00pm to 05:00pm	1 hour
18.	04-10-21	Transistors Layout Diagrams for NMOS	04:00pm to 05:00pm	1 hour
19.	05-10-21	Scaling of MOS circuits	04:00pm to 05:00pm	1 hour
20.	06-10-21	Gate Level Design: Logic Gates and	04:00pm to 05:00pm	1 hour
21.	07-10-21	Switch logic, Alternate gate circuits	04:00pm to 05:00pm	1 hour
22.	18-10-21	Time delays, Subsystem Design	04:00pm to 05:00pm	1 hour
23.	19-10-21	Data Path Subsystems:	04:00pm to 05:00pm	1 hour
24.	20-10-21	Shifters, Adders, ALUs, Multipliers,	04:00pm to 05:00pm	1 hour
25.	21-10-21	Comparators, Zero/One Detectors	04:00pm to 05:00pm	1 hour
26.	22-10-21	Counters. Array Subsystems: SRAM,	04:00pm to 05:00pm	1 hour



*Principal*  
PRINCIPAL  
Vignans Institute of Management & Technology For Women  
Kondapur(V), Ghatkesar(M), Medchal-Malkajgiri(D)-501301  
Telangana State

27.	23-10-21	ROM, Serial Access Memories, DRAM	04:00pm to 05:00pm	1 hour
28.	25-10-21	Design Approach – PLA, PAL	04:00pm to 05:00pm	1 hour
29.	26-10-21	Standard Cells FPGAs, CPLDs	04:00pm to 05:00pm	1 hour
30.	27-10-21	CMOS Testing, Test Principles	04:00pm to 05:00pm	1 hour
31.	28-10-21	Design Strategies for test	04:00pm to 05:00pm	1 hour
32.	29-10-21	Chip level Test Techniques	04:00pm to 05:00pm	1 hour
33.	30-10-21	Test conducted, feedback taken	04:00pm to 05:00pm	1 hour
<b>Total – 33hours</b>				

  
CO ORDINATOR

  
HOD

Head of the Department  
Electronics and Communications Engineering  
Vignan's Institute of Management and Technology for Women  
Kondapur (V), Ghatkesar (M), Medchal-Malkajgiri (DI)-501301



  
PRINCIPAL

Vignan's Institute of Management & Technology for Women  
Kondapur(V), Ghatkesar(M), Medchal-Malkajgiri(DI)-501301  
Telangana State





# VIGNAN'S INSTITUTE OF MANAGEMENT AND TECHNOLOGY FOR WOMEN

Sponsored by Lavu Educational Society, Approved by AICTE, New Delhi & Affiliated to JNTUH, Hyderabad.  
Kondapur (V), Ghatkesar (M), Medchal - Malkajgiri (D) - 501 301 Phone: +91 96529 10002/3



## DEPARTMENT OF ELECTRONICS AND COMMUNICATION ENGINEERING

ADD ON COURSE NAME: Modern Chip Design and Its Applications

ADDON COURSE STUDENT REGISTRATION FORM

Academic Year : 2021-2022

Date : 07-09-2021

B.Tech IV-I SEM

SECTION : ECE-A

S.No	Roll number	Name of the student	Signature
1.	18UPIA0401	ADDANKI DHARANI	A. Dhareni
2.	18UPIA0402	ADUSUMILLI SRILASYA	Srilasya
3.	18UPIA0403	ARROJU VAISHNAVI	Arroju
4.	18UPIA0404	BANDARI MOUNIKA	MOUNIKA.
5.	18UPIA0405	BATTULA SANGEETHA	S. Sangeetha
6.	18UPIA0406	CHINTAKUNTA RASAGNA	R. Rasagna
7.	18UPIA0407	DAMMANNAPETA SOUJANYA	Soujanya
8.	18UPIA0408	DESHAM SRIVANI	S. Srivani
9.	18UPIA0409	DIGAJARLA SNEHITHA	S. Snehitha
10.	18UPIA0410	GAMPALA MADHURI	M. Madhuri
11.	18UPIA0412	GANDHE AKANKSHA	G. Akanksha
12.	18UPIA0413	GANNA KAVYA	G. Kavya
13.	18UPIA0414	GATTU MOUNIKA	G. Mounika
14.	18UPIA0415	GIRINENI DIVYA	D. Divya
15.	18UPIA0417	GUNTUPALLI MIDHUNA	M. Midhuna
16.	18UPIA0418	GURUGUBELLI SUSHMA	G. Sushma
17.	18UPIA0419	JAGINI SHARANYA	S. Sharanya
18.	18UPIA0420	JANAGAMA SRIVIDHYA	S. Vidhya
19.	18UPIA0421	JOGIRAJU AKSHARA	A. Akshara
20.	18UPIA0422	JONNALAGADDA DEEPTHI	D. Deepthi
21.	18UPIA0423	K HARIPRIYA	H. Haripriya
22.	18UPIA0424	KANCHARLA SRUTHI	K. Sruthi
23.	18UPIA0425	KONAMUTLA JHANSI	J. Jhansi
24.	18UPIA0426	KOTA LIKHITHA	L. Likhitha
25.	18UPIA0427	KOTHA SWATHI	S. Swathi
26.	18UPIA0428	KOTLA SONY	K. Sony
27.	18UPIA0429	KOTTAM AKHILA	K. Akhila
28.	18UPIA0430	KUNTA DEEPIKA	D. Deepika



*(Signature)*  
PRINCIPAL

Vignans Institute of Management & Technology For Women  
Kondapur(V), Ghatkesar(M), Medchal-Malkajgiri(D)-501301  
Telangana State

29.	18UP1A0431	LADALLA PAVANI	Pavani
30.	18UP1A0432	MADDI SRIVIDYA	Sri Vidya
31.	18UP1A0433	MALAMANTI MOUNIKA	Mounika
32.	18UP1A0434	MAREPALLY ADITI SAI	Aditi
33.	18UP1A0435	MITTA AKSHITHA	Akshitha
34.	18UP1A0436	MOROJU KUSUMA	Kusuma
35.	18UP1A0437	MOTAMARRI MEGHANA	Meghana
36.	18UP1A0438	N GAYATHRI	Gayathri
37.	18UP1A0439	N RUPARANI	Ruparani
38.	18UP1A0440	NACHU SHIVANI	Shivani
39.	18UP1A0442	PEDDI AISHWARYA	Aishwarya
40.	18UP1A0443	PULUSANI VARSHITHA	Varshitha
41.	18UP1A0444	REDDYGARI JAHNAVI REDDY	Jahnavi
42.	18UP1A0445	SAMALA POOJA	Pooja
43.	18UP1A0446	SHAIK ZEENATH	Zeenath
44.	18UP1A0447	SINGIRIKONDA AISHWARYA	Aishwarya
45.	18UP1A0448	SUKKA SHARANYA	Sharanya
46.	18UP1A0449	SUNKARABOINA AMOOL SIRI	Amool Siri
47.	18UP1A0450	TANGUTURI NIHARIKA	Niharika
48.	18UP1A0451	VEERAMALLA MANASA	Manasa
49.	18UP1A0452	VUPPUGANDLA SREEJA	Sreeja
50.	18UP1A0453	YELLOJU SRAVANI	Sravani
51.	19UP5A0401	ABRABOINA SAIKUMARI	Saikumari
52.	19UP5A0402	ADEPU SHIVANI	Shivani
53.	19UP5A0403	BANDI JHANSI	Jhansi
54.	19UP5A0404	BATHINI NIVEDITHA	Niveditha
55.	19UP5A0405	BODDIREDDY RAVALI	Ravali
56.	19UP5A0407	GANDHARI SHAILAJA	Shailaja

  
COORDINATOR

  
HOD

Head of the Department  
Electronics and Communication Engineering  
Vignani Institute of Management & Technology For Women  
Kondapur (V), Ghatkesar (M), Medchal-Malkajgiri (Dt)-501301



  
PRINCIPAL  
Vignani's Institute of Management & Technology For Women  
Kondapur(V), Ghatkesar(M), Medchal-Malkajgiri(Dt)-501301  
Telangana State



# VIGNAN'S INSTITUTE OF MANAGEMENT AND TECHNOLOGY FOR WOMEN

Sponsored by Laxmi Educational Society, Approved by AICTE, New Delhi & Affiliated to JNTUH, Hyderabad.  
Kondapur (V), Ghatkesar (M), Medchal - Malkajgiri (D) - 501 301 Phone: +91 98529 10002/3



## DEPARTMENT OF ELECTRONICS AND COMMUNICATION ENGINEERING

ADD ON COURSE NAME: **Modern Chip Design and Its Applications**

ADDON COURSE STUDENT REGISTERED LIST

Academic Year : 2021-2022

Date : 07-09-2021

B.Tech IV-I SEM

SECTION : ECE-A

S.No	Roll Number	Name of the Student
1	18UPIA0401	ADDANKI DHARANI
2	18UPIA0402	ADUSUMILLI SRILASYA
3	18UPIA0403	ARROJU VAISHNAVI
4	18UPIA0404	BANDARI MOUNIKA
5	18UPIA0405	BATTULA SANGEETHA
6	18UPIA0406	CHINTAKUNTA RASAGNA
7	18UPIA0407	DAMMANNAPETA SOUJANYA
8	18UPIA0408	DESHAM SRIVANI
9	18UPIA0409	DIGAJARLA SNEHITHA
10	18UPIA0410	GAMPALA MADHURI
11	18UPIA0412	GANDHE AKANKSHA
12	18UPIA0413	GANNA KAVYA
13	18UPIA0414	GATTU MOUNIKA
14	18UPIA0417	GUNTUPALLI MIDHUNA
15	18UPIA0418	GURUGUBELLI SUSHMA
16	18UPIA0419	JAGINI SHARANYA
17	18UPIA0420	JANAGAMA SRIVIDHYA
18	18UPIA0421	JOGIRAJU AKSHARA
19	18UPIA0422	JONNALAGADDA DEEPTHI
20	18UPIA0423	K HARIPRIYA
21	18UPIA0424	KANCHARLA SRUTHI
22	18UPIA0425	KONAMUTLA JHANSI
23	18UPIA0426	KOTA LIKHITHA
24	18UPIA0427	KOTHA SWATHI
25	18UPIA0428	KOTLA SONY
26	18UPIA0429	KOTTAM AKHILA
27	18UPIA0431	LADALLA PAVANI
28	18UPIA0432	MADDI SRIVIDYA
29	18UPIA0433	MALAMANTI MOUNIKA
30	18UPIA0434	MAREPALLY ADITI SAI
31	18UPIA0435	MITTA AKSHITHA
32	18UPIA0436	MOROJU KUSUMA
33	18UPIA0437	MOTAMARRI MEGHANA



  
PRINCIPAL

Vignani's Institute of Management & Technology For Women  
Kondapur(V), Ghatkesar(M), Medchal-Malkajgiri(D)-501301  
Telangana State

34	18UP1A0439	N RUPARANI
35	18UP1A0440	NACHU SHIVANI
36	18UP1A0442	PEDDI AISHWARYA
37	18UP1A0443	PULUSANI VARSHITHA
38	18UP1A0444	REDDYGARI JAHNAVI REDDY
39	18UP1A0445	SAMALA POOJA
40	18UP1A0446	SHAIK ZEENATH
41	18UP1A0447	SINGIRIKONDA AISHWARYA
42	18UP1A0449	SUNKARABOINA AMOOL SIRI
43	18UP1A0450	TANGUTURI NIHARIKA
44	18UP1A0451	VEERAMALLA MANASA
45	18UP1A0452	VUPPUGANDLA SREEJA
46	18UP1A0453	YELLOJU SRAVANI
47	19UP5A0401	ABRABOINA SAIKUMARI
48	19UP5A0403	BANDI JHANSI
49	19UP5A0404	BATHINI NIVEDITHA
50	19UP5A0405	BODDIREDDY RAVALI

  
COORDINATOR

  
HOD

Head of the Department  
Electronics and Communication Engineering  
Vignana Institute of Management & Technology For Women  
Kondapur (V), Ghatkesar (M), Medchal-Malkajgiri (D), Telangana State - 501301



  
PRINCIPAL

Vignana Institute of Management & Technology For Women  
Kondapur(V), Ghatkesar(M), Medchal-Malkajgiri(D)-501301  
Telangana State



# VIGNAN'S INSTITUTE OF MANAGEMENT AND TECHNOLOGY FOR WOMEN

Sponsored by Lawu Educational Society, Approved by AICTE, New Delhi & Affiliated to JNTUH, Hyderabad.  
Kondapur (V), Ghatkesar (M), Medchal - Malkajgiri (D) - 501 301 Phone: +91 96529 10002/3



## DEPARTMENT OF ELECTRONICS AND COMMUNICATION ENGINEERING

ADD ON COURSE NAME: Modern Chip Design and Its Applications

ADDON COURSE STUDENT REGISTRATION FORM

Academic Year : 2021-2022

Date : 07-09-2021

B.Tech IV-I SEM

SECTION : ECE-B

S.No	Roll number	Name of the student	Signature
1.	18UPIA0454	ARSHIA JABEEN	Arshia
2.	18UPIA0455	ATLURU SINDHUJA	Sindhuja
3.	18UPIA0456	B SOUMYA	Soumya
4.	18UPIA0457	MOTUPALLI BHAVANA SAI PRIYA	Saipriya
5.	18UPIA0458	BODDIREDDY SAI ASHRITHA	Sai Ashritha
6.	18UPIA0459	B ABHIGNA	Abhigna
7.	18UPIA0460	BOGGULA VENKATA KRISHNA	Venkata Krishna
8.	18UPIA0461	BORRA LIKITHA	Likitha
9.	18UPIA0462	C KAVYA SREE	Kavya Sree
10.	18UPIA0463	CHALASANI SRI SAI BHUVANESWARI	Sri Sai Bhuvaneshwari
11.	18UPIA0464	CHALLA TEJASWINI	Teja
12.	18UPIA0465	GADUSU NAVYA	Navya
13.	18UPIA0466	GUMMADEELA LAKSHMI PRASANNA	G. Lakshmi
14.	18UPIA0467	GURRAM SRAVANTHI	Sravanthi
15.	18UPIA0468	JAKKA DEEPTHI	Deepti
16.	18UPIA0469	JAKKA KEERTHI	Keerthi
17.	18UPIA0471	KANDADI POOJA	Pooja
18.	18UPIA0472	KARI DIVYA SRI SAI DURGA	Divya
19.	18UPIA0473	KODALI RUPA	Rupa
20.	18UPIA0474	KOLA SNIGDHA	Snigdha
21.	18UPIA0475	KOPPULA BHAVANA	Bhavana
22.	18UPIA0476	KURREMULA SAI SOWJANNYA	Sai Sowjanya
23.	18UPIA0477	MALKEYAGARU SATHWIKI REDDY	Sathwika
24.	18UPIA0478	MANDALA SHRESTA	Shresta
25.	18UPIA0479	MARAMPALLY APOORVA	Apoorva
26.	18UPIA0480	MOMULA VASANTHA LAXMI	Vasantha Lakshmi
27.	18UPIA0481	MULLAPUDI YOSHITHA NAGA SAI LAKSHMI	Yoshitha Lakshmi
28.	18UPIA0482	NANDYALA VARSHITHA	Varshitha



*[Signature]*  
PRINCIPAL

Vignans Institute of Management & Technology For Women  
Kondapur(V), Ghatkesar(M), Medchal-Malkajgiri(D)-501301  
Telangana State

29.	18UP1A0483	PODURI MEHER SESHASREE	SA
30.	18UP1A0484	PESARU SHIVANI	-
31.	18UP1A0486	P. NAGA VIJAYA VYSHNAVI	Vis
32.	18UP1A0487	PAPPULA VARSHITHA	Varshitha
33.	18UP1A0488	PEDDI RASHMITHA	RA
34.	18UP1A0489	PEDDIREDDY PRAVALIKA	PL
35.	18UP1A0490	PENDYALA BHOO MIKA	-
36.	18UP1A0491	POCHAMPALLI HARINI	P. Harini
37.	18UP1A0492	PODDUTURI ANVITHA	Anvitha
38.	18UP1A0493	POTHUGANTI MADHUNITHA	Madhunitha
39.	18UP1A0494	PULLURU SRAVANI	Sravani
40.	18UP1A0495	PYATA PRANANJALI REDDY	Prananjali
41.	18UP1A0496	SANTI SREEJA REDDY	S.P.
42.	18UP1A0497	SARANGA NAVYA SRI	NAVYA SRI
43.	18UP1A0498	SAVIRIGAM SRAVYA	Sravya
44.	18UP1A0499	SUDHAGONI SINDHU	Sindhu
45.	18UP1A04A0	TENKASALA SHRUTHI MADHURI	Madhuri
46.	18UP1A04A1	VEERAMREDDY SATVIKA	-
47.	18UP1A04A2	VUYYALA SREEJA	Sreeja
48.	18UP1A04A3	YERRA SUSHMITHA	Sushmitha
49.	19UP5A0408	K RENUKA	Renuka
50.	19UP5A0409	NIMMA JHANSI	Jhansi
51.	19UP5A0410	NURCHU SHIRISHA	SHIRISHA
52.	19UP5A0411	NUTENKI SINDHU	Sindhu
53.	19UP5A0412	POOSALA KEERTHY	-
54.	19UP5A0413	S. AKHILA	Akhila
55.	19UP5A0414	VORUGANTI AKANKASHA	Aka

  
COORDINATOR

  
HOD

Head of the Department  
Electronics and Communication Engineering  
Vignee's Institute of Management & Technology  
Kandepur (V), Ghatkesar (M), Medchal-Malkajgiri (D)-501301



  
PRINCIPAL

Vignee's Institute of Management & Technology For Women  
Kandepur(V), Ghatkesar(M), Medchal-Malkajgiri(D)-501301  
Telangana State



# VIGNAN'S INSTITUTE OF MANAGEMENT AND TECHNOLOGY FOR WOMEN

Sponsored by Lavu Educational Society, Approved by AICTE, New Delhi & Affiliated to JNTUH, Hyderabad.  
Kondapur (V), Ghatkesar (M), Medchal - Malkajgiri (D) - 501 301 Phone: +91 96529 10002/3



## DEPARTMENT OF ELECTRONICS AND COMMUNICATION ENGINEERING

ADD ON COURSE NAME: Modern Chip Design and Its Applications

ADDON COURSE STUDENT REGISTERED LIST

Academic Year : 2021-2022

Date : 07-09-2021

B.Tech IV-I SEM

SECTION : ECE-B

S.No	Roll Number	Name of the Student
1	18UP1A0454	ARSHIA JABEEN
2	18UP1A0455	ATLURU SINDHUJA
3	18UP1A0456	B SOUMYA
4	18UP1A0457	MOTUPALLI BHAVANA SAI PRIYA
5	18UP1A0458	BODDIREDDY SAI ASHRITHA
6	18UP1A0459	B ABHIGNA
7	18UP1A0460	BOGGULA VENKATA KRISHNA
8	18UP1A0461	BORRA LIKITHA
9	18UP1A0462	C KAVYA SREE
10	18UP1A0463	CHALASANI SRI SAI BHUVANESWARI
11	18UP1A0464	CHALLA TEJASWINI
12	18UP1A0465	GADUSU NAVYA
13	18UP1A0466	GUMMADEELA LAKSHMI PRASANNA
14	18UP1A0468	JAKKA DEEPTHI
15	18UP1A0469	JAKKA KEERTHI
16	18UP1A0471	KANDADI POOJA
17	18UP1A0472	KARI DIVYA SRI SAI DURGA
18	18UP1A0473	KODALI RUPA
19	18UP1A0474	KOLA SNIGDHA
20	18UP1A0475	KOPPULA BHAVANA
21	18UP1A0476	KURREMULA SAI SOWJANNYA
22	18UP1A0477	MALKEYAGARU SATHWIKI REDDY
23	18UP1A0478	MANDALA SHRESTA
24	18UP1A0479	MARAMPALLY APOORVA
25	18UP1A0480	MOMULA VASANTHA LAXMI
26	18UP1A0481	M.YOSHITHA NAGA SAI LAKSHMI
27	18UP1A0482	NANDYALA VARSHITHA
28	18UP1A0483	PODURI MEHER SESHASREE
29	18UP1A0486	P. NAGA VIJAYA VYSHNAVI
30	18UP1A0487	PAPPULA VARSHITHA
31	18UP1A0488	PEDDI RASHMITHA



*[Signature]*  
PRINCIPAL  
Vignans Institute of Management & Technology For Women  
Kondapur(V), Ghatkesar(M), Medchal-Malkajgiri(D)-501301  
Telangana State

32	18UP1A0489	PEDDIREDDY PRAVALIKA
33	18UP1A0491	POCHAMPALLI HARINI
34	18UP1A0492	PODDUTURI ANVITHA
35	18UP1A0493	POTHUGANTI MADHUNITHA
36	18UP1A0494	PULLURU SRAVANI
37	18UP1A0495	PYATA PRANANJALI REDDY
38	18UP1A0496	SANTI SREEJA REDDY
39	18UP1A0497	SARANGA NAVYA SRI
40	18UP1A0498	SAVIRIGAM SRAVYA
41	18UP1A0499	SUDHAGONI SINDHU
42	18UP1A04A0	TENKASALA SHRUTHI MADHURI
43	18UP1A04A2	VUYYALA SREEJA
44	18UP1A04A3	YERRA SUSHMITHA
45	19UP5A0408	K RENUKA
46	19UP5A0409	NIMMA JHANSI
47	19UP5A0410	NURCHU SHIRISHA
48	19UP5A0411	NUTENKI SINDHU
49	19UP5A0413	S. AKHILA
50	19UP5A0414	VORUGANTI AKANKASHA

  
COORDINATOR

  
HOD

Head of the Department  
Electronics and Communication Engineering  
Vignans Institute of Management & Technology For Women  
Kondapur(V), Ghatkesar(M), Medchal-Malkajgiri(DJ)-501301



  
PRINCIPAL

Vignans Institute of Management & Technology For Women  
Kondapur(V), Ghatkesar(M), Medchal-Malkajgiri(DJ)-501301  
Telangana State





# VIGNAN'S INSTITUTE OF MANAGEMENT AND TECHNOLOGY FOR WOMEN

Sponsored by Javva Educational Society, Approved by AICTE, New Delhi & Affiliated to JNTUH, Hyderabad.  
Kondapur (V), Ghatkesar (M), Medchal - Malkajgiri (D) - 501 301 Phone: +91 96529 10002/3



## DEPARTMENT OF ELECTRONICS AND COMMUNICATION ENGINEERING

ADD ON COURSE NAME: Modern Chip Design and Its Applications

DAY WISE ATTENDANCE SHEET

Academic Year : 2021-2022

Date : 13-09-2021

B.Tech IV-I SEM

SECTION : ECE-A

S.No	Roll Number	13-09-21	14-09-21	15-09-21	16-09-21	17-09-21
1	18UPIA0401	A.Dharani	A.Dharani	A.Dharani	A.Dharani	A.Dharani
2	18UPIA0402	Srilasya	Srilasya	Srilasya	Srilasya	Srilasya
3	18UPIA0403	<del>wp</del>	<del>wp</del>	<del>wp</del>	<del>wp</del>	<del>wp</del>
4	18UPIA0404	Mounika	Mounika	Mounika	Mounika	Mounika
5	18UPIA0405	SL	SL	SL	SL	SL
6	18UPIA0406	Pan	Pan	Pan	Pan	Pan
7	18UPIA0407	Soujanya	Soujanya	Soujanya	Soujanya	Soujanya
8	18UPIA0408	Sivada	Sivada	Sivada	Sivada	Sivada
9	18UPIA0409	Snakitha	Snakitha	Snakitha	Snakitha	Snakitha
10	18UPIA0410	Ca	Ca	Ca	Ca	Ca
11	18UPIA0412	G.Akanksha	G.Akanksha	G.Akanksha	G.Akanksha	G.Akanksha
12	18UPIA0413	Gikavya	Gikavya	Gikavya	Gikavya	Gikavya
13	18UPIA0414	G.mounika	G.mounika	G.mounika	G.mounika	G.mounika
14	18UPIA0417	W	W	W	W	W
15	18UPIA0418	G.Sushma	AB	G.Sushma	G.Sushma	G.Sushma
16	18UPIA0419	Sharmya	Sharmya	Sharmya	Sharmya	Sharmya
17	18UPIA0420	Sri Vidhya	Sri Vidhya	Sri Vidhya	Sri Vidhya	Sri Vidhya
18	18UPIA0421	Abhaya	Abhaya	Abhaya	Abhaya	Abhaya
19	18UPIA0422	Deepthi	Deepthi	Deepthi	Deepthi	Deepthi
20	18UPIA0423	Flaxi	Flaxi	Flaxi	Flaxi	Flaxi
21	18UPIA0424	SL	SL	SL	SL	SL
22	18UPIA0425	Shani	Shani	Shani	Shani	Shani
23	18UPIA0426	hith	hith	hith	hith	hith
24	18UPIA0427	Sudha	Sudha	Sudha	Sudha	Sudha
25	18UPIA0428	K-Sony	K-Sony	K-Sony	K-Sony	K-Sony
26	18UPIA0429	K Akhila	K Akhila	K Akhila	K Akhila	K Akhila
27	18UPIA0431	Pavani	Pavani	Pavani	Pavani	Pavani
28	18UPIA0432	Sri Vidya	Sri Vidya	Sri Vidya	Sri Vidya	AB
29	18UPIA0433	Mounika	Mounika	Mounika	Mounika	Mounika
30	18UPIA0434	Aditi	Aditi	Aditi	Aditi	Aditi



*[Signature]*  
PRINCIPAL  
Vignans Institute of Management & Technology For Women  
Kondapur(V), Ghatkesar(M), Medchal-Malkajgiri(D)-501301  
Telangana State

31	18UPIA0435	AK	AK	AK	AK	AK
32	18UPIA0436	KUSUMIA	KUSUMIA	KUSUMIA	KUSUMIA	KUSUMIA
33	18UPIA0437	MY	MY	MY	MY	MY
34	18UPIA0439	P	P	P	P	P
35	18UPIA0440	Q	Q	Q	Q	Q
36	18UPIA0442	AISHWARYA	AISHWARYA	AISHWARYA	AISHWARYA	AISHWARYA
37	18UPIA0443	Varshitha	Varshitha	Varshitha	Varshitha	Varshitha
38	18UPIA0444	Jahat	Jahat	Jahat	Jahat	Jahat
39	18UPIA0445	Pooja	Pooja	Pooja	Pooja	Pooja
40	18UPIA0446	zeenath	zeenath	zeenath	zeenath	zeenath
41	18UPIA0447	Ashwarya	Ashwarya	Ashwarya	Ashwarya	Ashwarya
42	18UPIA0449	AB	AB	AB	AB	AB
43	18UPIA0450	Nilamb	Nilamb	Nilamb	Nilamb	Nilamb
44	18UPIA0451	Manasa	Manasa	Manasa	Manasa	Manasa
45	18UPIA0452	Sreeja	AB	Sreeja	Sreeja	Sreeja
46	18UPIA0453	Soravani	Soravani	Soravani	Soravani	Soravani
47	19UPSA0401	Saij	Saij	Saij	Saij	Saij
48	19UPSA0403	Jlans	Jlans	Jlans	Jlans	Jlans
49	19UPSA0404	Niveditha	Niveditha	Niveditha	Niveditha	Niveditha
50	19UPSA0405	Rajit	Rajit	Rajit	Rajit	Rajit

  
COORDINATOR

  
HOD

Head of the Department  
Electronics and Communication Engineering  
Vignans Institute of Management & Technology For Women  
Kondapur (V), Ghatkesar (M), Medchal-Maikajguda (Dt)-501301



  
PRINCIPAL

Vignans Institute of Management & Technology For Women  
Kondapur(V), Ghatkesar(M), Medchal-Maikajguda(Dt)-501301  
Telangana State



# VIGNAN'S INSTITUTE OF MANAGEMENT AND TECHNOLOGY FOR WOMEN

Sponsored by Lavu Educational Society, Approved by AICTE, New Delhi & Affiliated to JNTUH, Hyderabad.  
Kondapur (V), Ghatkesar (M), Medchal - Malkajgiri (D) - 501 301 Phone: +91 96529 10002/3



## DEPARTMENT OF ELECTRONICS AND COMMUNICATION ENGINEERING

ADD ON COURSE NAME: Modern Chip Design and Its Applications

DAY WISE ATTENDANCE SHEET

Academic Year : 2021-2022

Date : 13-09-2021

B.Tech IV-I SEM

SECTION : ECE-B

S.No	Roll Number	13-09-21	14-09-21	15-09-21	16-09-21	17-09-21
1	18UPIA0454	Amr	Amr	Amr	Amr	Amr
2	18UPIA0455	Amr	Amr	Amr	Amr	Amr
3	18UPIA0456	Amr	Amr	Amr	Amr	Amr
4	18UPIA0457	Saipaiya	Saipaiya	Saipaiya	Saipaiya	Saipaiya
5	18UPIA0458	Sai Ashritha	Sai Ashritha	Sai Ashritha	Sai Ashritha	Sai Ashritha
6	18UPIA0459	Abhigna	Abhigna	Abhigna	Abhigna	Abhigna
7	18UPIA0460	Venkata Lakshmi	Venkata Lakshmi	Venkata Lakshmi	Venkata Lakshmi	Venkata Lakshmi
8	18UPIA0461	Lakshmi	Lakshmi	Lakshmi	Lakshmi	Lakshmi
9	18UPIA0462	Kavya Sree	Kavya Sree	Kavya Sree	Kavya Sree	Kavya Sree
10	18UPIA0463	Teja	Teja	Teja	Teja	Teja
11	18UPIA0464	Teja	Teja	Teja	Teja	Teja
12	18UPIA0465	Aranya	Aranya	Aranya	Aranya	Aranya
13	18UPIA0466	G. Lakshmi	G. Lakshmi	G. Lakshmi	G. Lakshmi	G. Lakshmi
14	18UPIA0468	Amr	Amr	Amr	Amr	Amr
15	18UPIA0469	Keerthi	Keerthi	Keerthi	Keerthi	Keerthi
16	18UPIA0471	Preraj	Preraj	Preraj	Preraj	Preraj
17	18UPIA0472	Durga	Durga	Durga	Durga	Durga
18	18UPIA0473	Rupa	Rupa	Rupa	Rupa	Rupa
19	18UPIA0474	Amr	Amr	Amr	Amr	Amr
20	18UPIA0475	K. Bhavana	K. Bhavana	K. Bhavana	K. Bhavana	K. Bhavana
21	18UPIA0476	Amr	Amr	Amr	Amr	Amr
22	18UPIA0477	Sath	Sath	Sath	Sath	Sath
23	18UPIA0478	Shrestha	Shrestha	Shrestha	Shrestha	Shrestha
24	18UPIA0479	Amr	Amr	Amr	Amr	Amr
25	18UPIA0480	Vasitha	Vasitha	Vasitha	Vasitha	Vasitha
26	18UPIA0481	Lakshmi	Lakshmi	Lakshmi	Lakshmi	Lakshmi
27	18UPIA0482	Vasitha	Vasitha	Vasitha	Vasitha	Vasitha
28	18UPIA0483	Amr	Amr	Amr	Amr	Amr
29	18UPIA0486	Amr	Amr	Amr	Amr	Amr



Principal  
Vignans Institute of Management & Technology For Women  
Kondapur(V), Ghatkesar(M), Medchal-Malkajgiri(D) - 501301  
Telangana State

30	18UP1A0487	varshitha	varshitha	varshitha	varshitha
31	18UP1A0488	<del>AB</del>	<del>AB</del>	<del>AB</del>	<del>AB</del>
32	18UP1A0489	P1	P1	1 AB	P1
33	18UP1A0491	P.Hansa	P.Hansa	P.Hansa	P.Hansa
34	18UP1A0492	Arpitha	Arpitha	Arpitha	Arpitha
35	18UP1A0493	Madhuvitha	Madhuvitha	Madhuvitha	Madhuvitha
36	18UP1A0494	Sravani	Sravani	Sravani	Sravani
37	18UP1A0495	Pranajak	Pranajak	Pranajak	Pranajak
38	18UP1A0496	Sh	Sh	Sh	Sh
39	18UP1A0497	NAVYASRI	NAVYASRI	NAVYASRI	NAVYASRI
40	18UP1A0498	Sravya	Sravya	Sravya	Sravya
41	18UP1A0499	Srinitha	Srinitha	Srinitha	Srinitha
42	18UP1A04A0	Madhu	Madhuri	Madhu	Madhuri
43	18UP1A04A2	Shreeja	Shreeja	Shreeja	Shreeja
44	18UP1A04A3	Sushmita	Sushmita	Sushmita	Sushmita
45	19UP5A0408	Renuka	Renuka	Renuka	Renuka
46	19UP5A0409	Ilansi	Ilansi	Ilansi	Ilansi
47	19UP5A0410	SHRISHA	SHRISHA	SHRISHA	SHRISHA
48	19UP5A0411	Sindhu	Sindhu	Sindhu	Sindhu
49	19UP5A0413	Akhila	Akhila	Akhila	Akhila
50	19UP5A0414	Ak	Ak	Ak	Ak

  
COORDINATOR

  
HOD

Head of the Department  
Electronics and Communication Engineering  
Vignas Institute of Management & Technology For Women  
Kondapur (V), Ghatkesar (M), Medchal-Malkajgiri (DR)-501301  
Telangana State



  
PRINCIPAL  
Vignas Institute of Management & Technology For Women  
Kondapur(V), Ghatkesar(M), Medchal-Malkajgiri(DR)-501301  
Telangana State



# VIGNAN'S INSTITUTE OF MANAGEMENT AND TECHNOLOGY FOR WOMEN

Sponsored by Laxmi Educational Society, Approved by AICTE, New Delhi & Affiliated to JNTUH, Hyderabad.  
Kondapur (V), Ghatkesar (M), Medchal - Malkajgiri (D) - 501 301 Phone: +91 96529 10002/3



## DEPARTMENT OF ELECTRONICS AND COMMUNICATION ENGINEERING

ADD ON COURSE NAME: Modern Chip Design and Its Applications

DAY WISE ATTENDANCE SHEET

Academic Year : 2021-2022

Date : 18-09-2021

B. Tech IV-I SEM

SECTION : ECE-A

S.No	Roll Number	18-09-21	20-09-21	21-09-21	22-09-21	23-09-21
1	18UPIA0401	A. Dharani	A. Dharani	A. Dharani	A. Dharani	A. Dharani
2	18UPIA0402	Srilaxya	Srilaxya	Srilaxya	Srilaxya	Srilaxya
3	18UPIA0403	Mounika	Mounika	Mounika	Mounika	Mounika
4	18UPIA0404	Mounika	Mounika	Mounika	Mounika	Mounika
5	18UPIA0405	Ra	Ra	Ra	Ra	Ra
6	18UPIA0406	Ra	Ra	Ra	Ra	Ra
7	18UPIA0407	Soujanya	Soujanya	Soujanya	Soujanya	Soujanya
8	18UPIA0408	Soujanya	Soujanya	Soujanya	Soujanya	Soujanya
9	18UPIA0409	AA	Prakritha	Prakritha	Prakritha	Prakritha
10	18UPIA0410	Ge	Ge	Ge	Ge	Ge
11	18UPIA0412	G. Akanksha	G. Akanksha	G. Akanksha	G. Akanksha	G. Akanksha
12	18UPIA0413	G. Kavya	G. Kavya	G. Kavya	G. Kavya	G. Kavya
13	18UPIA0414	G. Manika	G. Manika	G. Manika	G. Manika	G. Manika
14	18UPIA0417	M	M	M	M	M
15	18UPIA0418	G. Sushma	G. Sushma	G. Sushma	G. Sushma	G. Sushma
16	18UPIA0419	Shravya	Shravya	Shravya	Shravya	Shravya
17	18UPIA0420	Sri Vidhya	Sri Vidhya	Sri Vidhya	Sri Vidhya	Sri Vidhya
18	18UPIA0421	Abhaya	Abhaya	Abhaya	Abhaya	Abhaya
19	18UPIA0422	Deepthi	Deepthi	Deepthi	Deepthi	Deepthi
20	18UPIA0423	Flori	Flori	Flori	Flori	Flori
21	18UPIA0424	S	S	S	S	S
22	18UPIA0425	Shruti	Shruti	Shruti	Shruti	Shruti
23	18UPIA0426	Kit	Kit	Kit	Kit	Kit
24	18UPIA0427	Sruja	Sruja	Sruja	Sruja	Sruja
25	18UPIA0428	K. Sony	K. Sony	K. Sony	K. Sony	K. Sony
26	18UPIA0429	K. Akhila	K. Akhila	K. Akhila	K. Akhila	K. Akhila
27	18UPIA0431	Pavani	Pavani	Pavani	Pavani	Pavani
28	18UPIA0432	Sri Vidhya	Sri Vidhya	Sri Vidhya	Sri Vidhya	Sri Vidhya
29	18UPIA0433	Mounika	Mounika	Mounika	Mounika	Mounika
30	18UPIA0434	Aarti	Aarti	Aarti	Aarti	Aarti



*Adh*  
PRINCIPAL

Vignans Institute of Management & Technology For Women  
Kondapur(V), Ghatkesar(M), Medchal-Malkajgiri(D)-501301  
Telangana State

31	18UPIA0435	(A) f	(A) f	(A) f	(A) f	(A) f
32	18UPIA0436	KUSUMA	KUSUMA	KUSUMA	KUSUMA	KUSUMA
33	18UPIA0437	(M) f	(M) f	(M) f	(M) f	(M) f
34	18UPIA0439	(P) f	(P) f	(P) f	(P) f	(P) f
35	18UPIA0440	(S) f	(S) f	(S) f	(S) f	(S) f
36	18UPIA0442	AISHWARYA	AISHWARYA	AISHWARYA	AISHWARYA	AISHWARYA
37	18UPIA0443	Varshitha	Varshitha	Varshitha	Varshitha	Varshitha
38	18UPIA0444	Jah f	Jah f	Jah f	Jah f	Jah f
39	18UPIA0445	Pooja	Pooja	Pooja	Pooja	Pooja
40	18UPIA0446	zeenath	zeenath	zeenath	zeenath	zeenath
41	18UPIA0447	Ashwarya	AB	Ashwarya	Ashwarya	Ashwarya
42	18UPIA0449	(A) f	(A) f	(A) f	(A) f	(A) f
43	18UPIA0450	Nilata	Nilata	Nilata	Nilata	Nilata
44	18UPIA0451	Manasa	Manasa	Manasa	Manasa	Manasa
45	18UPIA0452	Sreeraj	Sreeraj	Sreeraj	Sreeraj	Sreeraj
46	18UPIA0453	Sivakani	Sivakani	Sivakani	Sivakani	Sivakani
47	19UP5A0401	(S) f	(S) f	(S) f	(S) f	(S) f
48	19UP5A0403	Ilani	Ilani	Ilani	Ilani	Ilani
49	19UP5A0404	Niveditha	Niveditha	Niveditha	Niveditha	Niveditha
50	19UP5A0405	(R) f	(R) f	(R) f	(R) f	(R) f

  
COORDINATOR

  
HOD

Head of the Department  
Electronics and Communication Engineering  
Vignans Institute of Management & Technology For Women  
Kondapur (V), Medchal-Malkajgiri (M), Telangana State (T), 501301



  
PRINCIPAL  
Vignans Institute of Management & Technology For Women  
Kondapur(V), Ghatkesar(M), Medchal-Malkajgiri(T), 501301  
Telangana State



# VIGNAN'S INSTITUTE OF MANAGEMENT AND TECHNOLOGY FOR WOMEN

Sponsored by Law Educational Society, Approved by AICTE, New Delhi & Affiliated to JNTUH, Hyderabad.  
Kondapur (V), Ghatkesar (M), Medchal - Malkajgiri (D) - 501 301 Phone: +91 96529 10002/3



## DEPARTMENT OF ELECTRONICS AND COMMUNICATION ENGINEERING

ADD ON COURSE NAME: Modern Chip Design and Its Applications

DAY WISE ATTENDANCE SHEET

Academic Year : 2021-2022

Date : 18-09-2021

B. Tech IV-I SEM

SECTION : ECE-B

S.No	Roll Number	18-09-21	20-09-21	21-09-21	22-09-21	23-09-21
1	18UPIA0454	Present	Present	Present	Present	Present
2	18UPIA0455	Present	Present	Present	Present	Present
3	18UPIA0456	Present	Present	Present	Present	Present
4	18UPIA0457	Saishriya	Saishriya	Saishriya	Saishriya	Saishriya
5	18UPIA0458	Saishriya	Saishriya	Saishriya	Saishriya	Saishriya
6	18UPIA0459	Abhigna	Abhigna	Abhigna	Abhigna	Abhigna
7	18UPIA0460	Venkata Lakshmi	Venkata Lakshmi	Venkata Lakshmi	Venkata Lakshmi	Venkata Lakshmi
8	18UPIA0461	Lakshmi	Lakshmi	Lakshmi	Lakshmi	Lakshmi
9	18UPIA0462	Kavya Sree	Kavya Sree	Kavya Sree	Kavya Sree	Kavya Sree
10	18UPIA0463	Teja	Teja	Teja	Teja	Teja
11	18UPIA0464	Teja	Teja	Teja	Teja	Teja
12	18UPIA0465	Teja	Teja	Teja	Teja	Teja
13	18UPIA0466	G. Lakshmi	G. Lakshmi	G. Lakshmi	G. Lakshmi	G. Lakshmi
14	18UPIA0468	Present	Present	Present	Present	Present
15	18UPIA0469	Keerthi	Keerthi	Keerthi	Keerthi	Keerthi
16	18UPIA0471	Pragna	Pragna	Pragna	Pragna	Pragna
17	18UPIA0472	Divya	Divya	Divya	Divya	Divya
18	18UPIA0473	Rupa	Rupa	Rupa	Rupa	Rupa
19	18UPIA0474	Pragna	Pragna	Pragna	Pragna	Pragna
20	18UPIA0475	K. Bhavana	K. Bhavana	K. Bhavana	K. Bhavana	K. Bhavana
21	18UPIA0476	Present	Present	Present	Present	Present
22	18UPIA0477	Sath	Sath	Sath	Sath	Sath
23	18UPIA0478	Shreya	Shreya	Shreya	Shreya	Shreya
24	18UPIA0479	Present	Present	Present	Present	Present
25	18UPIA0480	Vasudha	Vasudha	Vasudha	Vasudha	Vasudha
26	18UPIA0481	Lakshmi	Lakshmi	Lakshmi	Lakshmi	Lakshmi
27	18UPIA0482	Varshitha	Varshitha	Varshitha	AB	Varshitha
28	18UPIA0483	Present	Present	Present	Present	Present
29	18UPIA0486	Present	Present	Present	Present	Present
30	18UPIA0487	Varshitha	Varshitha	Varshitha	Varshitha	Varshitha



Vignans Institute of Management & Technology For Women  
Kondapur(V), Ghatkesar(M), Medchal-Malkajgiri(D)-501301  
Telangana State

31	18UPIA0488	<del>Bus</del>	<del>Bus</del>	<del>Bus</del>	<del>Bus</del>	<del>Bus</del>
32	18UPIA0489	<del>P.1</del>	<del>P.1</del>	<del>P</del>	<del>P</del>	<del>P</del>
33	18UPIA0491	<del>P.Hanna</del>	<del>P.Hanna</del>	<del>P.Hanna</del>	<del>P.Hanna</del>	<del>P.Hanna</del>
34	18UPIA0492	<del>Armitha</del>	<del>Armitha</del>	<del>Armitha</del>	<del>Armitha</del>	<del>Armitha</del>
35	18UPIA0493	<del>Madhumitha</del>	<del>Madhumitha</del>	<del>Madhumitha</del>	<del>Madhumitha</del>	<del>Madhumitha</del>
36	18UPIA0494		Sravani	sravani	Sravan	Sravan
37	18UPIA0495	<del>Pranaya</del>	<del>Pranaya</del>	<del>Pranaya</del>	<del>Pranaya</del>	<del>Pranaya</del>
38	18UPIA0496	<del>Pr</del>	<del>Pr</del>	<del>Pr</del>	<del>Pr</del>	<del>Pr</del>
39	18UPIA0497	<del>NAVYASRI</del>	<del>NAVYASRI</del>	<del>NAVYASRI</del>	<del>NAVYASRI</del>	<del>NAVYASRI</del>
40	18UPIA0498	<del>Swarna</del>	<del>Swarna</del>	<del>Swarna</del>	<del>Swarna</del>	<del>Swarna</del>
41	18UPIA0499	Srinthu	Srinthu	Srinthu	Srinthu	Srinthu
42	18UPIA04A0	Madhu	Madhu	Madhu	Madhu	Madhu
43	18UPIA04A2	(Sreya)	(Sreya)	(Sreya)	(Sreya)	(Sreya)
44	18UPIA04A3	Sushmita	Sushmita	Sushmita	Sushmita	Sushmita
45	19UP5A0408	Renuka	Renuka	Renuka	AB	Renuka
46	19UP5A0409	Ilana	Ilana	Ilana	Ilana	Ilana
47	19UP5A0410	SHRISHA	SHRISHA	SHRISHA	SHRISHA	SHRISHA
48	19UP5A0411	Sindhu	Sindhu	Sindhu	Sindhu	Sindhu
49	19UP5A0413	Akhila	Akhila	Akhila	Akhila	Akhila
50	19UP5A0414	Abi	Abi	Abi	Abi	Abi

  
COORDINATOR

  
HOD



Head of the Department  
Electronics and Communication Engineering  
Vignans Institute of Management & Technology For Women  
Kondapur (V), Ghatkesar (M), Medchal-Malkajgiri (D)-501301

  
PRINCIPAL  
Vignans Institute of Management & Technology For Women  
Kondapur(V),Ghatkesar(M),Medchal-Malkajgiri(D)-501301  
Telangana State





# VIGNAN'S INSTITUTE OF MANAGEMENT AND TECHNOLOGY FOR WOMEN

Sponsored by Laxmi Educational Society, Approved by AICTE, New Delhi & Affiliated to JNTUH, Hyderabad.  
Kondapur (V), Ghatkesar (M), Medchal - Malkajgiri (D) - 501 301 Phone: +91 96529 10002/3



## DEPARTMENT OF ELECTRONICS AND COMMUNICATION ENGINEERING

ADD ON COURSE NAME: Modern Chip Design and Its Applications

DAY WISE ATTENDANCE SHEET

Academic Year : 2021-2022

Date : 24-09-2021

B.Tech IV-I SEM

SECTION : ECE-A

S.No	Roll Number	24-09-21	25-09-21	27-09-21	28-09-21	29-09-21
1	18UPIA0401	A. Dharani	A. Dharani	A. Dharani	A. Dharani	A. Dharani
2	18UPIA0402	Srilasya	Srilasya	Srilasya	Srilasya	Srilasya
3	18UPIA0403	trp U	trp U	trp U	AR	trp U
4	18UPIA0404	Mounika	Mounika	Mounika	Mounika	Mounika
5	18UPIA0405	Ra	Sl	Sl	Sl	Sl
6	18UPIA0406	Ra	Ra	Ra	Ra	Ra
7	18UPIA0407	Sowanya	Sowanya	Sowanya	Sowanya	Sowanya
8	18UPIA0408	Sowanya	Sowanya	Sowanya	Sowanya	Sowanya
9	18UPIA0409	Snehalitha	Snehalitha	Snehalitha	Snehalitha	Snehalitha
10	18UPIA0410	Ar	Ar	Ar	Ar	Ar
11	18UPIA0412	G. Akanksha	G. Akanksha	G. Akanksha	G. Akanksha	G. Akanksha
12	18UPIA0413	G. Kavya	G. Kavya	G. Kavya	G. Kavya	G. Kavya
13	18UPIA0414	G. Manika	G. Manika	G. Manika	G. Manika	G. Manika
14	18UPIA0417	Ra	Ra	Ra	Ra	Ra
15	18UPIA0418	G. Sushma	G. Sushma	G. Sushma	G. Sushma	G. Sushma
16	18UPIA0419	Sharanya	Sharanya	Sharanya	Sharanya	Sharanya
17	18UPIA0420	Sri Vidhya	Sri Vidhya	Sri Vidhya	Sri Vidhya	Sri Vidhya
18	18UPIA0421	Akhara	Akhara	Akhara	Akhara	Akhara
19	18UPIA0422	Deepthi	Deepthi	Deepthi	Deepthi	Deepthi
20	18UPIA0423	AR	Flari	Flari	Flari	Flari
21	18UPIA0424	Sl	Sl	Sl	Sl	Sl
22	18UPIA0425	Flari	Flari	Flari	Flari	Flari
23	18UPIA0426	hith	hith	hith	hith	hith
24	18UPIA0427	Sneha	Sneha	Sneha	Sneha	Sneha
25	18UPIA0428	K. Sony	K. Sony	K. Sony	K. Sony	K. Sony
26	18UPIA0429	K. Akhila	E. Akhila	E. Akhila	K. Akhila	E. Akhila
27	18UPIA0431	Parani	Parani	Parani	Parani	Parani
28	18UPIA0432	Sri Vidya	Sri Vidya	Sri Vidya	Sri Vidya	Sri Vidya
29	18UPIA0433	Mounika	Mounika	Mounika	Mounika	Mounika



*[Signature]*  
PRINCIPAL

Vignans Institute of Management & Technology for Women  
Kondapur (V), Ghatkesar (M), Medchal - Malkajgiri (D), 501301  
Telangana State

30	18UPIA0434	Aditi	Aditi	Aditi	Aditi	Aditi
31	18UPIA0435	Arup	Arup	Arup	Arup	Arup
32	18UPIA0436	Kusuma	Kusuma	Kusuma	Kusuma	Kusuma
33	18UPIA0437	Arif	Arif	Arif	Arif	Arif
34	18UPIA0439	P	P	P	P	P
35	18UPIA0440	Arif	Arif	Arif	Arif	Arif
36	18UPIA0442	AISHWARYA	AISHWARYA	AISHWARYA	AISHWARYA	AISHWARYA
37	18UPIA0443	Valshitta	Valshitta	Valshitta	Valshitta	Valshitta
38	18UPIA0444	Jahul	Jahul	Jahul	Jahul	Jahul
39	18UPIA0445	Boja	Boja	Boja	Boja	Boja
40	18UPIA0446	Zeenath	Zeenath	Zeenath	Zeenath	Zeenath
41	18UPIA0447	Abhaya	Abhaya	Abhaya	Abhaya	Abhaya
42	18UPIA0449	Asif	Asif	Asif	Asif	Asif
43	18UPIA0450	Nilak	Nilak	Nilak	Nilak	Nilak
44	18UPIA0451	Manasa	AB	Manasa	Manasa	Manasa
45	18UPIA0452	Sreya	Sreya	Sreya	Sreya	Sreya
46	18UPIA0453	Sravani	Sravani	Sravani	Sravani	Sravani
47	19UP5A0401	Sait	Sait	Sait	Sait	Sait
48	19UP5A0403	Ilant	Ilant	Ilant	Ilant	Ilant
49	19UP5A0404	Niveditha	Niveditha	Niveditha	Niveditha	Niveditha
50	19UP5A0405	Parif	Parif	Parif	Parif	Parif

  
COORDINATOR

  
HOD

Head of the Department  
Electronics and Communication Engineering  
Vignans Institute of Management & Technology For Women  
Kondapur (V), Ghatkesar (M), Medchal-Nalgonda (D)-501301



  
PRINCIPAL

Vignans Institute of Management & Technology-For Women  
Kondapur(V), Ghatkesar(M), Medchal-Nalgonda(D)-501301  
Telangana State



# VIGNAN'S INSTITUTE OF MANAGEMENT AND TECHNOLOGY FOR WOMEN

Sponsored by Law Educational Society, Approved by AICTE, New Delhi & Affiliated to JNTUH, Hyderabad.  
Kondapur (V), Ghatkesar (M), Medchal - Malkajgiri (D) - 501 301 Phone: +91 96529 10002/3



## DEPARTMENT OF ELECTRONICS AND COMMUNICATION ENGINEERING

ADD ON COURSE NAME: Modern Chip Design and Its Applications

DAY WISE ATTENDANCE SHEET

Academic Year : 2021-2022

Date : 24-09-2021

B.Tech IV-I SEM

SECTION : ECE-B

S.No	Roll Number	24-09-21	25-09-21	27-09-21	28-09-21	29-09-21
1	18UPIA0454	Present	Present	Present	Present	Present
2	18UPIA0455	Present	Present	Present	Present	Present
3	18UPIA0456	Present	Present	Present	Present	Present
4	18UPIA0457	Sai Priya	Sai Priya	Sai Priya	Sai Priya	Sai Priya
5	18UPIA0458	Sai Ashritha	Sai Ashritha	Sai Ashritha	Sai Ashritha	Sai Ashritha
6	18UPIA0459	Abhina	Abhina	Abhina	Abhina	Abhina
7	18UPIA0460	Venkata Lakshmi	Venkata Lakshmi	Venkata Lakshmi	Venkata Lakshmi	Venkata Lakshmi
8	18UPIA0461	Lakshmi	Lakshmi	Lakshmi	Lakshmi	Lakshmi
9	18UPIA0462	Kavya Sree	Kavya Sree	Kavya Sree	Kavya Sree	Kavya Sree
10	18UPIA0463	BA	BA	BA	BA	BA
11	18UPIA0464	Taja	Taja	Taja	Taja	Taja
12	18UPIA0465	Divya	Divya	Divya	Divya	Divya
13	18UPIA0466	G Lakshmi	G Lakshmi	G Lakshmi	G Lakshmi	G Lakshmi
14	18UPIA0468	Present	Present	Present	Present	Present
15	18UPIA0469	Keerthi	Keerthi	Keerthi	Keerthi	Keerthi
16	18UPIA0471	Pooja	Pooja	Pooja	Pooja	Pooja
17	18UPIA0472	Divya	Divya	Divya	Divya	Divya
18	18UPIA0473	Rupa	Rupa	Rupa	Rupa	Rupa
19	18UPIA0474	Smriti	Smriti	Smriti	Smriti	Smriti
20	18UPIA0475	K.Bhavana	K.Bhavana	K.Bhavana	K.Bhavana	K.Bhavana
21	18UPIA0476	Present	Present	Present	Present	Present
22	18UPIA0477	Sath	Sath	Sath	Sath	Sath
23	18UPIA0478	Shrestha	Shrestha	Shrestha	Shrestha	Shrestha
24	18UPIA0479	Present	Present	Present	Present	Present
25	18UPIA0480	Nasrath	Nasrath	Nasrath	Nasrath	Nasrath
26	18UPIA0481	Lakshmi	Lakshmi	Lakshmi	Lakshmi	Lakshmi
27	18UPIA0482	Varshitha	Varshitha	Varshitha	Varshitha	Varshitha
28	18UPIA0483	Present	Present	Present	Present	Present
29	18UPIA0486	Vis	Vis	Vis	Vis	Vis
30	18UPIA0487	Varshitha	Varshitha	Varshitha	Varshitha	Varshitha



*[Signature]*

PRINCIPAL

Vignana's Institute of Management & Technology For Women  
Kondapur(V), Ghatkesar(M), Medchal-Malkajgiri(D)-501301  
Telangana State

31	18UP1A0488	<del>Pu</del>	<del>Pu</del>	<del>Pu</del>	<del>Pu</del>	<del>Pu</del>
32	18UP1A0489	<del>Pu</del>	<del>Pu</del>	<del>Pu</del>	<del>Pu</del>	<del>Pu</del>
33	18UP1A0491	P.Hansi	P.Hansi	P.Hansi	P.Hansi	P.Hansi
34	18UP1A0492	Anitha	Anitha	Anitha	Anitha	Anitha
35	18UP1A0493	AB	Madhumitha	Madhumitha	Madhumitha	Madhumitha
36	18UP1A0494	Pranvi	Pranvi	Pranvi	Pranvi	Pranvi
37	18UP1A0495	Pranvi	Pranvi	Pranvi	Pranvi	Pranvi
38	18UP1A0496	Sl	Sl	Sl	Sl	Sl
39	18UP1A0497	NAVASRI	NAVASRI	NAVASRI	NAVASRI	NAVASRI
40	18UP1A0498	Pranvi	Pranvi	Pranvi	Pranvi	Pranvi
41	18UP1A0499	Pranvi	Pranvi	Pranvi	Pranvi	AB
42	18UP1A04A0	Madhu	Madhu	Madhu	Madhu	Madhu
43	18UP1A04A2	Pranvi	Pranvi	Pranvi	Pranvi	Pranvi
44	18UP1A04A3	Sushmita	Sushmita	Sushmita	Sushmita	Sushmita
45	19UP5A0408	Renuka	Renuka	Renuka	Renuka	Renuka
46	19UP5A0409	Jansi	Jansi	Jansi	Jansi	Jansi
47	19UP5A0410	SHRISHA	SHRISHA	SHRISHA	SHRISHA	SHRISHA
48	19UP5A0411	Sindhu	Sindhu	Sindhu	Sindhu	Sindhu
49	19UP5A0413	Akhila	Akhila	Akhila	Akhila	Akhila
50	19UP5A0414	At	At	At	At	At

  
COORDINATOR

  
HOD, ECE

Head of the Department  
Electronics and Communication Engineering  
Vignana's Institute of Management & Technology For Women  
Kondapur (V), Ghatkesar (M), Medchal-Malkajgiri (TS)-501301



  
PRINCIPAL

Vignana's Institute of Management & Technology For Women  
Kondapur(V), Ghatkesar(M), Medchal-Malkajgiri(TS)-501301  
Telangana State



# VIGNAN'S INSTITUTE OF MANAGEMENT AND TECHNOLOGY FOR WOMEN

Sponsored by Lavu Educational Society, Approved by AICTE, New Delhi & Affiliated to JNTUH, Hyderabad.  
Kondapur (V), Ghatekesar (M), Medchal - Malkajgiri (D) - 501 301 Phone: +91 96529 10002/3



## DEPARTMENT OF ELECTRONICS AND COMMUNICATION ENGINEERING

ADD ON COURSE NAME: Modern Chip Design and Its Applications

DAY WISE ATTENDANCE SHEET

Academic Year : 2021-2022

Date : 30-09-2021

B.Tech IV-I SEM

SECTION : ECE-A

S.No	Roll Number	30-09-21	01-10-21	04-10-21	05-10-21	06-10-21
1	18UPIA0401	A. Dharani	A. Dharani	A. Dharani	A. Dharani	A. Dharani
2	18UPIA0402	Srilasya	Srilasya	Srilasya	Srilasya	Srilasya
3	18UPIA0403	Wp	wp	wp	wp	wp
4	18UPIA0404	MOONIKA	MOONIKA	MOONIKA	MOONIKA	MOONIKA
5	18UPIA0405	Pa	Pa	Pa	Pa	Pa
6	18UPIA0406	Karu	Karu	Karu	Karu	Karu
7	18UPIA0407	Sowjanya	Sowjanya	Sowjanya	Sowjanya	Sowjanya
8	18UPIA0408	Sowjanya	Sowjanya	Sowjanya	Sowjanya	Sowjanya
9	18UPIA0409	Sreelatha	Sreelatha	Sreelatha	Sreelatha	Sreelatha
10	18UPIA0410	Pa	Pa	Pa	Pa	Pa
11	18UPIA0412	G. Anantksha	G. Anantksha	G. Anantksha	G. Anantksha	G. Anantksha
12	18UPIA0413	G. kavya	G. kavya	G. kavya	G. kavya	G. kavya
13	18UPIA0414	G. manika	G. manika	G. manika	G. manika	G. manika
14	18UPIA0417	M	M	M	M	M
15	18UPIA0418	G. Sushma	G. Sushma	G. Sushma	G. Sushma	G. Sushma
16	18UPIA0419	Sharma	Sharma	AB	Sharma	Sharma
17	18UPIA0420	Sri Vidhya	Sri Vidhya	Sri Vidhya	Sri Vidhya	Sri Vidhya
18	18UPIA0421	Akshata	Akshata	Akshata	Akshata	Akshata
19	18UPIA0422	Deepthi	Deepthi	Deepthi	Deepthi	Deepthi
20	18UPIA0423	Flori	Flori	Flori	Flori	Flori
21	18UPIA0424	Pa	Pa	Pa	Pa	Pa
22	18UPIA0425	Thani	Thani	Thani	Thani	Thani
23	18UPIA0426	Lidh	Lidh	Lidh	Lidh	Lidh
24	18UPIA0427	Suski	Suski	Suski	Suski	Suski
25	18UPIA0428	K. SONY	K. SONY	K. SONY	K. SONY	K. SONY
26	18UPIA0429	K. Akhila	K. Akhila	K. Akhila	K. Akhila	K. Akhila
27	18UPIA0431	Pavani	Pavani	Pavani	Pavani	Pavani
28	18UPIA0432	Sri Vidya	Sri Vidya	Sri Vidya	Sri Vidya	Sri Vidya



*[Signature]*

PRINCIPAL

Vignans Institute of Management & Technology For Women  
Kondapur(V), Ghatekesar(M), Medchal-Malkajgiri(D)-501301  
Telangana State

29	18UPIA0433	Mounika.	Mounika.	Mounika.	Mounika.	Mounika.
30	18UPIA0434	Aditi	Aditi	Aditi	Aditi	Aditi
31	18UPIA0435	Akshay	Akshay	Akshay	Akshay	Akshay
32	18UPIA0436	Kusuma	Kusuma	Kusuma	Kusuma	Kusuma
33	18UPIA0437	Mj	Mj	Mj	Mj	Mj
34	18UPIA0439	P.	P.	P.	P.	P.
35	18UPIA0440	Q.	Q.	Q.	Q.	Q.
36	18UPIA0442	ASHWARYA	ASHWARYA	ASHWARYA	ASHWARYA	ASHWARYA
37	18UPIA0443	Valshitta	Valshitta	Valshitta	Valshitta	Valshitta
38	18UPIA0444	Jahul	Jahul	Jahul	Jahul	Jahul
39	18UPIA0445	Boja	Boja	Boja	Boja	Boja
40	18UPIA0446	zeenath	zeenath	zeenath	zeenath	zeenath
41	18UPIA0447	Ashwarya	Ashwarya	Ashwarya	Ashwarya	Ashwarya
42	18UPIA0449	Adi	Adi	Adi	Adi	Adi
43	18UPIA0450	Nilans	Nilans	Nilans	Nilans	Nilans
44	18UPIA0451	Monata	Monata	Monata	Monata	Monata
45	18UPIA0452	Sreeja	Sreeja	Sreeja	Sreeja	Sreeja
46	18UPIA0453	Sravani	Sravani	Sravani	Sravani	Sravani
47	19UPSA0401	Sai	Sai	Sai	Sai	Sai
48	19UPSA0403	ilans	ilans	ilans	ilans	ilans
49	19UPSA0404	Niveditha	Niveditha	Niveditha	Niveditha	Niveditha
50	19UPSA0405	Raunf	Raunf	Raunf	Raunf	Raunf

  
COORDINATOR

  
HOD

Head of the Department  
Electronics and Communication Engineering  
Vignana Institute of Management & Technology For Women  
Kondapur (V), Ghatekeer (M), Medchal-Malkajgiri (DI)-501301



  
PRINCIPAL

Vignana's Institute of Management & Technology For  
Kondapur(V), Ghatekeer(M), Medchal-Malkajgiri(DI)-501301  
Telangana State



# VIGNAN'S INSTITUTE OF MANAGEMENT AND TECHNOLOGY FOR WOMEN

Sponsored by Laxmi Educational Society, Approved by AICTE, New Delhi & Affiliated to JNTUH, Hyderabad.  
Kondapur (V), Ghatkesar (M), Medchal - Malkajgiri (D) - 501 301 Phone: +91 98529 10002/3



## DEPARTMENT OF ELECTRONICS AND COMMUNICATION ENGINEERING

ADD ON COURSE NAME: Modern Chip Design and Its Applications

DAY WISE ATTENDANCE SHEET

Academic Year : 2021-2022

Date : 30-09-2021

B.Tech IV-I SEM

SECTION : ECE-B

S.No	Roll Number	30-09-21	01-10-21	04-10-21	05-10-21	06-10-21
1	18UPIA0454	Int	Int	Int	Int	Int
2	18UPIA0455	Int	Int	Int	Int	Int
3	18UPIA0456	Int	Int	Int	Int	Int
4	18UPIA0457	Saipariya	Saipariya	Saipariya	Saipariya	Saipariya
5	18UPIA0458	Saishritha	Saishritha	Saishritha	Saishritha	Saishritha
6	18UPIA0459	Abhigna	Abhigna	Abhigna	Abhigna	Abhigna
7	18UPIA0460	venkata (K)	venkata (K)	venkata (K)	AB	venkata (K)
8	18UPIA0461	Likitha	Likitha	Likitha	Likitha	Likitha
9	18UPIA0462	Kanya Sree	Kanya Sree	Kanya Sree	Kanya Sree	Kanya Sree
10	18UPIA0463	Int	Int	Int	Int	Int
11	18UPIA0464	Teja	Teja	Teja	Teja	Teja
12	18UPIA0465	Wavya	Wavya	Wavya	Wavya	Wavya
13	18UPIA0466	G.lakshmi	G.lakshmi	G.lakshmi	G.lakshmi	G.lakshmi
14	18UPIA0468	Int	Int	Int	Int	Int
15	18UPIA0469	Keesthi	Keesthi	Keesthi	Keesthi	Keesthi
16	18UPIA0471	Pooja	Pooja	Pooja	Pooja	Pooja
17	18UPIA0472	Durga	Durga	Durga	Durga	Durga
18	18UPIA0473	Rupa	Rupa	Rupa	Rupa	Rupa
19	18UPIA0474	snigdha	snigdha	snigdha	snigdha	snigdha
20	18UPIA0475	K.Bhavana	K.Bhavana	K.Bhavana	K.Bhavana	K.Bhavana
21	18UPIA0476	Int	Int	Int	Int	Int
22	18UPIA0477	Seetha	Seetha	Seetha	Seetha	Seetha
23	18UPIA0478	shreeta	shreeta	shreeta	shreeta	shreeta
24	18UPIA0479	Int	Int	Int	Int	Int
25	18UPIA0480	vasanthi	vasanthi	vasanthi	vasanthi	vasanthi
26	18UPIA0481	Lakshmi	Lakshmi	Lakshmi	Lakshmi	Lakshmi
27	18UPIA0482	varshitha	varshitha	varshitha	varshitha	varshitha
28	18UPIA0483	Int	Int	Int	Int	Int



*ASH*  
PRINCIPAL

Vignans Institute of Management & Technology For Women  
Kondapur(V), Ghatkesar(M), Medchal-Malkajgiri(D)-501301  
Telangana State

29	18UPIA0486	<del>Va</del>	<del>Va</del>	<del>Va</del>	<del>Va</del>	<del>Va</del>
30	18UPIA0487	Varshitha	varshitha	Varshitha	Varshitha	Varshitha
31	18UPIA0488	<del>Ru</del>	<del>Ru</del>	<del>Ru</del>	<del>Ru</del>	<del>Ru</del>
32	18UPIA0489	Ru	AB	Ru	Ru	Ru
33	18UPIA0491	<del>P.Hameed</del>	<del>P.Hameed</del>	<del>P.Hameed</del>	<del>P.Hameed</del>	<del>P.Hameed</del>
34	18UPIA0492	Amitha	Amitha	Amitha	Amitha	Amitha
35	18UPIA0493	Madhumitha	Madhumitha	Madhumitha	Madhumitha	Madhumitha
36	18UPIA0494	<del>Pranavi</del>	<del>Pranavi</del>	<del>Pranavi</del>	<del>Pranavi</del>	<del>Pranavi</del>
37	18UPIA0495	Pranavi	Pranavi	Pranavi	Pranavi	Pranavi
38	18UPIA0496	<del>SP</del>	<del>SP</del>	<del>SP</del>	<del>SP</del>	<del>SP</del>
39	18UPIA0497	NAVYASRI	NAVYASRI	NAVYASRI	NAVYASRI	NAVYASRI
40	18UPIA0498	<del>Pranvi</del>	<del>Pranvi</del>	<del>Pranvi</del>	<del>Pranvi</del>	<del>Pranvi</del>
41	18UPIA0499	Srinthu	Srinthu	Srinthu	Srinthu	Srinthu
42	18UPIA04A0	Madhu	Madhu	Madhu	Madhu	Madhu
43	18UPIA04A2	<del>Pranvi</del>	<del>Pranvi</del>	<del>Pranvi</del>	<del>Pranvi</del>	<del>Pranvi</del>
44	18UPIA04A3	Sushmita	Sushmita	Sushmita	Sushmita	Sushmita
45	19UP5A0408	Renuka	Renuka	Renuka	Renuka	Renuka
46	19UP5A0409	<del>Ilana</del>	<del>Ilana</del>	<del>Ilana</del>	<del>Ilana</del>	<del>Ilana</del>
47	19UP5A0410	SHRISHA	SHRISHA	SHRISHA	SHRISHA	SHRISHA
48	19UP5A0411	Sindhu	Sindhu	Sindhu	AB	Sindhu
49	19UP5A0413	Akhila	Akhila	Akhila	Akhila	Akhila
50	19UP5A0414	Al	Ah	Al	Ake	Al

  
COORDINATOR

  
HOD

Head of the Department  
Electronics and Communication Engineering  
Vignana Institute of Management & Technology For Women  
Kondapur (V), Ghatkesar (M), Medchal-Malkajgiri (DT)-501301



  
Vignana Institute of Management & Technology For Women  
Kondapur(V), Ghatkesar(M), Medchal-Malkajgiri(DT)-501301  
Telangana State





# VIGNAN'S INSTITUTE OF MANAGEMENT AND TECHNOLOGY FOR WOMEN

Sponsored by Law Educational Society, Approved by AICTE, New Delhi & Affiliated to JNTUH, Hyderabad.  
Kondapur (V), Ghatkesar (M), Medchal - Malkajgiri (D) - 501 301 Phone: +91 96529 10002/3



## DEPARTMENT OF ELECTRONICS AND COMMUNICATION ENGINEERING

ADD ON COURSE NAME: Modern Chip Design and Its Applications

DAY WISE ATTENDANCE SHEET

Academic Year : 2021-2022

Date : 07-10-2021

B.Tech IV-I SEM

SECTION : ECE-A

S.No	Roll Number	07-10-21	08-10-21	18-10-21	19-10-21	20-10-21
1	18UPIA0401	A.Dharani	A.Dharani	A.Dharani	A.Dharani	A.Dharani
2	18UPIA0402	Srilashya	Srilashya	Srilashya	Srilashya	Srilashya
3	18UPIA0403	if	if	if	if	if
4	18UPIA0404	Mounika	Mounika	Mounika	Mounika	Mounika
5	18UPIA0405	Pr	Pr	Pr	Pr	Pr
6	18UPIA0406	Ran	Ran	Ran	Ran	Ran
7	18UPIA0407	Soujanya	Soujanya	Soujanya	Soujanya	Soujanya
8	18UPIA0408	Sivani	Sivani	Sivani	Sivani	Sivani
9	18UPIA0409	Snehalitha	Snehalitha	Snehalitha	Snehalitha	Snehalitha
10	18UPIA0410	Ar	Ar	Ar	Ar	Ar
11	18UPIA0412	A.Arkantsha	A.Arkantsha	A.Arkantsha	A.Arkantsha	A.Arkantsha
12	18UPIA0413	Ghavya	Ghavya	Ghavya	Ghavya	Ghavya
13	18UPIA0414		G.mounika	G.mounika	G.mounika	G.mounika
14	18UPIA0417	M.	M.	M.	M.	M.
15	18UPIA0418	G.Sudhama	G.Sudhama	G.Sudhama	G.Sudhama	G.Sudhama
16	18UPIA0419	Sharanje	Sharanje	Sharanje	Sharanje	Sharanje
17	18UPIA0420	Sri Vidhya	Sri Vidhya	Sri Vidhya	Sri Vidhya	Sri Vidhya
18	18UPIA0421	Akshara	Akshara	Akshara	Akshara	Akshara
19	18UPIA0422	Deepthi	Deepthi	Deepthi	Deepthi	Deepthi
20	18UPIA0423	Harini	Harini	Harini	Harini	Harini
21	18UPIA0424	Pr	Pr	Pr	Pr	Pr
22	18UPIA0425	Prani	Prani	Prani	Prani	Prani
23	18UPIA0426	Lith	Lith	Lith	Lith	Lith
24	18UPIA0427	Sudhi	Sudhi	Sudhi	Sudhi	Sudhi
25	18UPIA0428	K.Sony	K.Sony	K.Sony	AB	K.Sony
26	18UPIA0429	K.Akhila	K.Akhila	K.Akhila	K.Akhila	K.Akhila
27	18UPIA0431	Parani	Parani	Parani	Parani	Parani
28	18UPIA0432	Sri Vidhya	Sri Vidhya	Sri Vidhya	Sri Vidhya	Sri Vidhya
29	18UPIA0433	Mounika	Mounika	Mounika	Mounika	Mounika



*ASU*  
PRINCIPAL

Vignani's Institute of Management & Technology For Women  
Kondapur(V), Ghatkesar(M), Medchal-Malkajgiri(D)-501301  
Telangana State

30	18UPIA0434	Aditi	Miti	Miti	Aditi	Aditi
31	18UPIA0435	Kusuma	Kusuma	Kusuma	Kusuma	Kusuma
32	18UPIA0436	Kusuma	Kusuma	Kusuma	Kusuma	Kusuma
33	18UPIA0437	Aditi	Miti	Miti	Aditi	Aditi
34	18UPIA0439	Aditi	Miti	Miti	Aditi	Aditi
35	18UPIA0440	Aditi	Miti	Miti	Aditi	Aditi
36	18UPIA0442	ASHWARYA	ASHWARYA	ASHWARYA	ASHWARYA	ASHWARYA
37	18UPIA0443	Vasshitta	Vasshitta	Vasshitta	Vasshitta	Vasshitta
38	18UPIA0444	Jahit	Jahit	Jahit	Jahit	Jahit
39	18UPIA0445	Pooja	Pooja	Pooja	Pooja	Pooja
40	18UPIA0446	Zeenath	Zeenath	Zeenath	Zeenath	Zeenath
41	18UPIA0447	ASHWARYA	ASHWARYA	ASHWARYA	ASHWARYA	ASHWARYA
42	18UPIA0449	Aditi	Aditi	Aditi	Aditi	Aditi
43	18UPIA0450	Nilank	Nilank	Nilank	Nilank	Nilank
44	18UPIA0451	Monika	Monika	Monika	Monika	Monika
45	18UPIA0452	Sreepa	Sreepa	Sreepa	Sreepa	Sreepa
46	18UPIA0453	Sravani	Sravani	Sravani	Sravani	Sravani
47	19UP5A0401	Sai	Sai	Sai	Sai	Sai
48	19UP5A0403	Jlank	Jlank	Jlank	Jlank	Jlank
49	19UP5A0404	Niveditha	Niveditha	Niveditha	Niveditha	Niveditha
50	19UP5A0405	Aditi	Aditi	Aditi	Aditi	Aditi

  
COORDINATOR

  
HOD

Head of the Department  
Electronics and Communication Engineering  
Vignans Institute of Management & Technology For Women  
Kondapur (M), Ghadigal (M), Madhav Nagar (D), Pin-501301



  
PRINCIPAL  
Vignans Institute of Management & Technology For Women  
Kondapur (M), Ghadigal (M), Madhav Nagar (D), Pin-501301  
Telangana, India



# VIGNAN'S INSTITUTE OF MANAGEMENT AND TECHNOLOGY FOR WOMEN

Sponsored by Law Education Society, Approved by AICTE, New Delhi & Affiliated to JNTU, Hyderabad.  
Kondapur (V), Ghatkesar (M), Medchal - Malkajgiri (D) - 501 301 Phone: +91 96529 10002/3



## DEPARTMENT OF ELECTRONICS AND COMMUNICATION ENGINEERING

ADD ON COURSE NAME: Modern Chip Design and Its Applications

DAY WISE ATTENDANCE SHEET

Academic Year : 2021-2022

Date : 07-10-2021

B.Tech IV-I SEM

SECTION : ECE-B

S.No	Roll Number	07-10-21	08-10-21	18-10-21	19-10-21	20-10-21
1	18UPIA0454	Present	Present	Present	Present	Present
2	18UPIA0455	Present	Present	Present	Present	Present
3	18UPIA0456	Present	Present	Present	Present	Present
4	18UPIA0457	Sai Priya	Saipriya	Saipriya	Saipriya	Saipriya
5	18UPIA0458	Sai Abhinav	Sai Abhinav	Sai Abhinav	Sai Abhinav	Sai Abhinav
6	18UPIA0459	Abhinav	Abhinav	Abhinav	Abhinav	Abhinav
7	18UPIA0460	Venkata Sai	Venkata Sai	Venkata Sai	Venkata Sai	Venkata Sai
8	18UPIA0461	Likitha	Likitha	Likitha	Likitha	Likitha
9	18UPIA0462	Kavya Sree	Kavya Sree	Kavya Sree	Kavya Sree	Kavya Sree
10	18UPIA0463	Bh	Bh	Bh	Bh	Bh
11	18UPIA0464	Teja	Teja	Teja	Teja	Teja
12	18UPIA0465	Navya	Navya	Navya	Navya	Navya
13	18UPIA0466	G. Lakshmi	G. Lakshmi	G. Lakshmi	G. Lakshmi	G. Lakshmi
14	18UPIA0468	Present	Present	Present	Present	Present
15	18UPIA0469	Kaesthi	Kaesthi	Kaesthi	Kaesthi	Kaesthi
16	18UPIA0471	Pooja	Pooja	Pooja	Pooja	Pooja
17	18UPIA0472	Rusga	Rusga	Rusga	Rusga	Rusga
18	18UPIA0473	Rupa	Rupa	Rupa	Rupa	Rupa
19	18UPIA0474	Snigdha	Snigdha	Snigdha	Snigdha	Snigdha
20	18UPIA0475	K. Bhavana	K. Bhavana	K. Bhavana	AB	K. Bhavana
21	18UPIA0476	Present	Present	Present	Present	Present
22	18UPIA0477	Sath	Sath	Sath	Sath	Sath
23	18UPIA0478	Shrestha	Shrestha	Shrestha	Shrestha	Shrestha
24	18UPIA0479	Present	Present	Present	Present	Present
25	18UPIA0480	Vasundhara	Vasundhara	Vasundhara	Vasundhara	Vasundhara
26	18UPIA0481	Lakshmi	Lakshmi	Lakshmi	Lakshmi	Lakshmi
27	18UPIA0482	Varshitha	Varshitha	Varshitha	Varshitha	Varshitha
28	18UPIA0483	Present	Present	Present	Present	Present
29	18UPIA0486	Vis	Vis	Vis	Vis	Vis



*[Signature]*  
PRINCIPAL  
Vignans Institute of Management & Technology For Women  
Kondapur(V), Ghatkesar(M), Medchal-Malkajgiri(D)-501301  
Telangana State

30	18UPIA0487	Varshitha	varshitha	Varshitha	varshitha	Varshitha
31	18UPIA0488	Bsu	Bsu	Bsu	Bsu	Bsu
32	18UPIA0489	P.P	Pu	Pu	P	P
33	18UPIA0491	P.Hansi	P.Hansi	P.Hansi	P.Hansi	P.Hansi
34	18UPIA0492	Anvitha	Anvitha	Anvitha	Anvitha	Anvitha
35	18UPIA0493	Madhumitha	Madhumitha	Madhumitha	Madhumitha	Madhumitha
36	18UPIA0494	Sravani	Sravani	Sravani	Sravani	Sravani
37	18UPIA0495	Pramojita	Pramojita	Pramojita	Pramojita	Pramojita
38	18UPIA0496	Sh	Sh	Sh	Sh	Sh
39	18UPIA0497	NAYASRI	NAYASRI	NAYASRI	NAYASRI	NAYASRI
40	18UPIA0498	Sravya	Sravya	Sravya	Sravya	Sravya
41	18UPIA0499	Sindhu	Sindhu	Sindhu	Sindhu	Sindhu
42	18UPIA04A0	Madhu	Madhu	Madhu	Madhu	Madhu
43	18UPIA04A2	Deepa	AB	Deepa	Deepa	Deepa
44	18UPIA04A3	Sushmitha	Sushmitha	Sushmitha	Sushmitha	Sushmitha
45	19UP5A0408	Renuka	Renuka	Renuka	Renuka	Renuka
46	19UP5A0409	Jlani	Jlani	Jlani	Jlani	Jlani
47	19UP5A0410	SIRISHA	SIRISHA	SIRISHA	SIRISHA	SIRISHA
48	19UP5A0411	Sindhu	Sindhu	Sindhu	Sindhu	Sindhu
49	19UP5A0413	Akhila	Akhila	Akhila	Akhila	Akhila
50	19UP5A0414	Ash	Ash	Ash	Ash	Ash

  
COORDINATOR

  
HOD

Head of the Department  
Electronics and Communication Engineering  
Vignans Institute of Management & Technology For Women  
Kandapur (V), Ghatkesar (M), Medchal-Malkajgiri (D1)-501301



  
Vignans Institute of Management & Technology For Women  
Kandapur(V), Ghatkesar(M), Medchal-Malkajgiri(D1)-501301  
Telangana State



# VIGNAN'S INSTITUTE OF MANAGEMENT AND TECHNOLOGY FOR WOMEN

Sponsored by Lavu Educational Society, Approved by AICTE, New Delhi & Affiliated to JNTUH, Hyderabad, Kondapur (V), Ghatkesar (M), Medchal - Malkajgiri (D) - 501 301 Phone: +91 96529 10002/3



## DEPARTMENT OF ELECTRONICS AND COMMUNICATION ENGINEERING

ADD ON COURSE NAME: Modern Chip Design and Its Applications

DAY WISE ATTENDANCE SHEET

Academic Year : 2021-2022

Date : 21-10-2021

B.Tech IV-I SEM

SECTION : ECE-A

S.No	Roll Number	21-10-21	22-10-21	23-10-21	25-10-21	26-10-21
1	18UPIA0401	A Dharani	A Dharani	A Dharani	A Dharani	A Dharani
2	18UPIA0402	Srilasya	Srilasya	Srilasya	Srilasya	Srilasya
3	18UPIA0403	trf	trf	trf	trf	trf
4	18UPIA0404	Mounika	Mounika	Mounika	Mounika	Mounika
5	18UPIA0405	sl	sl	sl	sl	sl
6	18UPIA0406	Ravi	Ravi	Ravi	Ravi	Ravi
7	18UPIA0407	Soujanya	Soujanya	Soujanya	Soujanya	Soujanya
8	18UPIA0408	swathi	swathi	swathi	swathi	swathi
9	18UPIA0409	srulitha	srulitha	srulitha	srulitha	srulitha
10	18UPIA0410	tr	tr	tr	tr	tr
11	18UPIA0412	G.Aparajita	G.Aparajita	G.Aparajita	G.Aparajita	G.Aparajita
12	18UPIA0413	AB	G.Kavya	G.Kavya	G.Kavya	G.Kavya
13	18UPIA0414	G.mounika	G.mounika	G.mounika	G.mounika	G.mounika
14	18UPIA0417	tr	tr	tr	tr	tr
15	18UPIA0418	G.Sushma	G.Sushma	G.Sushma	G.Sushma	G.Sushma
16	18UPIA0419	Sharanje	Sharanje	Sharanje	Sharanje	Sharanje
17	18UPIA0420	Sri Vidhya	Sri Vidhya	Sri Vidhya	Sri Vidhya	Sri Vidhya
18	18UPIA0421	Akshara	Akshara	Akshara	Akshara	Akshara
19	18UPIA0422	Deepthi	Deepthi	Deepthi	Deepthi	Deepthi
20	18UPIA0423	Flori	Flori	Flori	Flori	Flori
21	18UPIA0424	tr	tr	tr	tr	tr
22	18UPIA0425	Flori	Flori	Flori	Flori	Flori
23	18UPIA0426	Litha	Litha	Litha	Litha	Litha
24	18UPIA0427	Swathi	Swathi	Swathi	Swathi	AB
25	18UPIA0428	K.Sony	K.Sony	K.Sony	K.Sony	K.Sony
26	18UPIA0429	K.Akhila	K.Akhila	K.Akhila	K.Akhila	K.Akhila
27	18UPIA0431	Pavani	Pavani	Pavani	Pavani	Pavani
28	18UPIA0432	Sri Vidya	Sri Vidya	Sri Vidya	Sri Vidya	Sri Vidya
29	18UPIA0433	Mounika	Mounika	Mounika	Mounika	Mounika



Principal

Vignans Institute of Management & Technology For Women  
Kondapur(V), Ghatkesar(M), Medchal Malkajgiri(D)-501301  
Telangana State

30	18UPIA0434	Aditi	Aditi	Aditi	Aditi
31	18UPIA0435	Aditi	Aditi	Aditi	Aditi
32	18UPIA0436	Kusuma	Kusuma	Kusuma	Kusuma
33	18UPIA0437	Aditi	Aditi	Aditi	Aditi
34	18UPIA0439	Aditi	Aditi	Aditi	Aditi
35	18UPIA0440	Aditi	Aditi	Aditi	Aditi
36	18UPIA0442	AISHWARYA	AISHWARYA	AISHWARYA	AISHWARYA
37	18UPIA0443	Vasshitha	Vasshitha	Vasshitha	Vasshitha
38	18UPIA0444	Jahul	Jahul	Jahul	Jahul
39	18UPIA0445	Pooja	Pooja	Pooja	Pooja
40	18UPIA0446	zeerath	zeerath	zeerath	zeerath
41	18UPIA0447	Ashwanya	Ashwanya	Ashwanya	Ashwanya
42	18UPIA0449	Aditi	Aditi	Aditi	Aditi
43	18UPIA0450	Nilank	Nilank	Nilank	Nilank
44	18UPIA0451	Mansa	Mansa	Mansa	Mansa
45	18UPIA0452	Sreya	Sreya	Sreya	Sreya
46	18UPIA0453	Srikanth	Srikanth	Srikanth	Srikanth
47	19UP5A0401	Sai	Sai	Sai	Sai
48	19UP5A0403	Ilani	Ilani	Ilani	Ilani
49	19UP5A0404	Niveditha	Niveditha	Niveditha	Niveditha
50	19UP5A0405	Rahul	Rahul	Rahul	Rahul

  
COORDINATOR

  
HOD

Head of the Department  
Electronics and Communication Engineering  
Yagna Institute of Management & Technology For Women  
Kondapur (V), Ghatkesar (M), Medchal-Malkajgiri (DT)-501301



  
PRINCIPAL  
Yagna's Institute of Management & Technology For Women  
Kondapur(V), Ghatkesar(M), Medchal-Malkajgiri(DT)-501301  
Telangana State



# VIGNAN'S INSTITUTE OF MANAGEMENT AND TECHNOLOGY FOR WOMEN

Sponsored by Lavu Educational Society, Approved by AICTE, New Delhi & Affiliated to JNTUH, Hyderabad.  
Kondapur (V), Ghatkesar (M), Medchal - Malkajgiri (D) - 501 301 Phone: +91 96529 10002/3



## DEPARTMENT OF ELECTRONICS AND COMMUNICATION ENGINEERING

ADD ON COURSE NAME: Modern Chip Design and Its Applications

DAY WISE ATTENDANCE SHEET

Academic Year : 2021-2022

Date : 21-10-2021

B.Tech IV-I SEM

SECTION : ECE-B

S.No	Roll Number	21-10-21	22-10-21	23-10-21	25-10-21	26-10-21
1	18UPIA0454	Present	Present	Present	Present	Present
2	18UPIA0455	Present	Present	Present	Present	Present
3	18UPIA0456	Present	Present	Present	Present	Present
4	18UPIA0457	Saipriya	Saipriya	Saipriya	Saipriya	Saipriya
5	18UPIA0458	Swathi	Swathi	Swathi	Swathi	Swathi
6	18UPIA0459	Abhishek	Abhishek	Abhishek	Abhishek	Abhishek
7	18UPIA0460	venkata	venkata	venkata	venkata	venkata
8	18UPIA0461	Lakshmi	Lakshmi	Lakshmi	Lakshmi	Lakshmi
9	18UPIA0462	Kavya	Kavya	Kavya	Kavya	Kavya
10	18UPIA0463	BIA	BIA	BIA	BIA	BIA
11	18UPIA0464	Tela	Tela	Tela	Tela	Tela
12	18UPIA0465	Anvika	Anvika	Anvika	Anvika	Anvika
13	18UPIA0466	G. Lakshmi	G. Lakshmi	G. Lakshmi	G. Lakshmi	G. Lakshmi
14	18UPIA0468	Present	Present	Present	Present	Present
15	18UPIA0469	Keerthi	Keerthi	Keerthi	Keerthi	Keerthi
16	18UPIA0471	Pooja	Pooja	Pooja	Pooja	Pooja
17	18UPIA0472	Durga	Durga	Durga	Durga	Durga
18	18UPIA0473	Rupa	Rupa	Rupa	Rupa	Rupa
19	18UPIA0474	Snigdha	Snigdha	Snigdha	Snigdha	Snigdha
20	18UPIA0475	K. Bhavana	K. Bhavana	K. Bhavana	K. Bhavana	K. Bhavana
21	18UPIA0476	Present	Present	Present	Present	Present
22	18UPIA0477	Sadhika	Sadhika	Sadhika	Sadhika	Sadhika
23	18UPIA0478	Shreya	Shreya	Shreya	Shreya	Shreya
24	18UPIA0479	Present	Present	Present	Present	Present
25	18UPIA0480	Nasirah	AB	Nasirah	Nasirah	Nasirah
26	18UPIA0481	Lakshmi	Lakshmi	Lakshmi	Lakshmi	Lakshmi
27	18UPIA0482	Varshitha	Varshitha	Varshitha	Varshitha	Varshitha
28	18UPIA0483	Present	Present	Present	Present	Present
29	18UPIA0486	Vidya	Vidya	Vidya	Vidya	Vidya



*[Signature]*  
PRINCIPAL

Vignans Institute of Management & Technology For Women  
Kondapur(V), Ghatkesar(M), Medchal-Malkajgiri(D)-501301  
Telangana State

30	18UPIA0487	Varshitha	Varshitha	Varshitha	Varshitha	Varshitha
31	18UPIA0488	Bu	Bu	Bu	Bu	Bu
32	18UPIA0489	P	P	P	P	P
33	18UPIA0491	P.Hansa	P.Hansa	P.Hansa	P.Hansa	P.Hansa
34	18UPIA0492	Arpitha	Arpitha	Arpitha	Arpitha	Arpitha
35	18UPIA0493	Madhumitha	Madhumitha	Madhumitha	Madhumitha	Madhumitha
36	18UPIA0494	Sravani	Sravani	Sravani	Sravani	Sravani
37	18UPIA0495	Pranjal	Pranjal	Pranjal	Pranjal	Pranjal
38	18UPIA0496	P	P	P	P	P
39	18UPIA0497	NAVYASRI	NAVYASRI	NAVYASRI	NAVYASRI	NAVYASRI
40	18UPIA0498	Sravan	Sravan	Sravan	Sravan	Sravan
41	18UPIA0499	Srinthu	Srinthu	Srinthu	Srinthu	Srinthu
42	18UPIA04A0	Madhu	Madhu	Madhu	Madhu	Madhu
43	18UPIA04A2	Sarja	Sarja	Sarja	Sarja	Sarja
44	18UPIA04A3	Sushmitha	Sushmitha	Sushmitha	Sushmitha	Sushmitha
45	19UP5A0408	Renuka	Renuka	Renuka	Renuka	Renuka
46	19UP5A0409	Ilana	Ilana	Ilana	Ilana	Ilana
47	19UP5A0410	SHRISHA	SHRISHA	SHRISHA	SHRISHA	SHRISHA
48	19UP5A0411	Sindhu	Sindhu	Sindhu	Sindhu	Sindhu
49	19UP5A0413	Akhila	Akhila	Akhila	Akhila	Akhila
50	19UP5A0414	A	A	A	A	A

  
COORDINATOR

  
HOD

Head of the Department  
Electronics and Communication Engineering  
Vignans Institute of Management & Technology For Women  
Kondapur (V), Ghatkesar (M), Medchal-Malkajgiri (D) - 501301



  
PRINCIPAL  
Vignans Institute of Management & Technology For Women  
Kondapur(V), Ghatkesar(M), Medchal-Malkajgiri(D) - 501301  
Telangana State





# VIGNAN'S INSTITUTE OF MANAGEMENT AND TECHNOLOGY FOR WOMEN

Sponsored by Lavu Educational Society, Approved by AICTE, New Delhi & Affiliated to JNTUH, Hyderabad.  
Kondapur (V), Ghatkesar (M), Medchal - Malkajgiri (D) - 501 301 Phone: +91 96529 10002/3



## DEPARTMENT OF ELECTRONICS AND COMMUNICATION ENGINEERING

ADD ON COURSE NAME: Modern Chip Design and Its Applications

DAY WISE ATTENDANCE SHEET

Academic Year : 2021-2022

Date : 27-10-2021

B.Tech IV-I SEM

SECTION : ECE-A

S.No	Roll Number	27-10-21	28-10-21	29-10-21	30-10-21
1	18UPIA0401	A. Dharani	A. Dharani	A. Dharani	A. Dharani
2	18UPIA0402	Srilasya	Srilasya	Srilasya	Srilasya
3	18UPIA0403	SRU	SRU	SRU	SRU
4	18UPIA0404	MOONIKA	MOONIKA	MOONIKA	MOONIKA
5	18UPIA0405	Sat	Sat	Sat	Sat
6	18UPIA0406	Rau	Rau	Rau	Rau
7	18UPIA0407	Sourabh	Sourabh	Sourabh	Sourabh
8	18UPIA0408	Sourabh	Sourabh	Sourabh	Sourabh
9	18UPIA0409	Snehalitha	Snehalitha	Snehalitha	Snehalitha
10	18UPIA0410	Am	Am	Am	Am
11	18UPIA0412	G. Anandhika	G. Anandhika	G. Anandhika	G. Anandhika
12	18UPIA0413	G. Kavya	G. Kavya	G. Kavya	G. Kavya
13	18UPIA0414	G. Manika	G. Manika	G. Manika	G. Manika
14	18UPIA0417	M	M	M	M
15	18UPIA0418	G. Sushma	G. Sushma	G. Sushma	G. Sushma
16	18UPIA0419	Shravya	Shravya	Shravya	Shravya
17	18UPIA0420	Sri Vidhya	Sri Vidhya	Sri Vidhya	Sri Vidhya
18	18UPIA0421	Anshu	Anshu	Anshu	Anshu
19	18UPIA0422	Deepthi	Deepthi	Deepthi	Deepthi
20	18UPIA0423	Harri	Harri	Harri	Harri
21	18UPIA0424	Sruithi	Sruithi	Sruithi	Sruithi
22	18UPIA0425	Rani	Rani	Rani	Rani
23	18UPIA0426	Litha	Litha	Litha	Litha
24	18UPIA0427	Saath	Saath	Saath	Saath
25	18UPIA0428	K. SONY	K. SONY	K. SONY	K. SONY
26	18UPIA0429	K. Akhila	K. Akhila	K. Akhila	K. Akhila
27	18UPIA0431	Pavani	Pavani	Pavani	Pavani
28	18UPIA0432	Sri Vidya	Sri Vidya	Sri Vidya	Sri Vidya
29	18UPIA0433	MOONIKA	MOONIKA	MOONIKA	MOONIKA



*Handwritten signature*

Vignans Institute of Management & Technology  
Kondapur(V), Ghatkesar(M), Medchal-Malkajgiri(D)-501301  
Telangana State

30	18UPIA0434	Aditi	Aditi	Aditi	Aditi	Aditi
31	18UPIA0435	Abir	Abir	Abir	Abir	Abir
32	18UPIA0436	Kusuma	Kusuma	Kusuma	Kusuma	Kusuma
33	18UPIA0437	Pranav	Pranav	Pranav	Pranav	Pranav
34	18UPIA0439	Pranav	Pranav	Pranav	Pranav	Pranav
35	18UPIA0440	Pranav	Pranav	Pranav	Pranav	Pranav
36	18UPIA0442	AISHWARYA	AISHWARYA	AISHWARYA	AISHWARYA	AISHWARYA
37	18UPIA0443	Vaishitha	Vaishitha	Vaishitha	Vaishitha	Vaishitha
38	18UPIA0444	Jahat	Jahat	Jahat	Jahat	Jahat
39	18UPIA0445	Pooja	AB	Pooja	Pooja	Pooja
40	18UPIA0446	Zeenath	Zeenath	Zeenath	Zeenath	Zeenath
41	18UPIA0447	Aishwarya	Aishwarya	Aishwarya	Aishwarya	Aishwarya
42	18UPIA0449	Asif	Asif	Asif	Asif	Asif
43	18UPIA0450	Nilam	Nilam	Nilam	Nilam	Nilam
44	18UPIA0451	Manasa	Manasa	Manasa	Manasa	Manasa
45	18UPIA0452	Sreya	Sreya	Sreya	Sreya	Sreya
46	18UPIA0453	Soravani	Soravani	Soravani	Soravani	Soravani
47	19UPS A0401	Galp	Galp	Galp	Galp	Galp
48	19UPS A0403	Ilant	Ilant	Ilant	Ilant	Ilant
49	19UPS A0404	Niveditha	Niveditha	Niveditha	Niveditha	Niveditha
50	19UPS A0405	Pranav	Pranav	Pranav	Pranav	Pranav

  
COORDINATOR

  
HOD

Head of the Department  
Electronics and Communication Engineering  
Vignans Institute of Management & Technology For Women  
Gandhar V, Guntur VV, Andhra Pradesh (DL)-501301



  
PRINCIPAL  
Vignans Institute of Management & Technology For Women  
Kondapur(V), Guntur(M), Medchal-Malkajgiri(DL)-501301  
Telangana State



# VIGNAN'S INSTITUTE OF MANAGEMENT AND TECHNOLOGY FOR WOMEN

Sponsored by Lawu Educational Society, Approved by AICTE, New Delhi & Affiliated to JNTUH, Hyderabad.  
Kondapur (V), Ghatkesar (M), Medchal - Malkajgiri (D) - 501 301 Phone: +91 96529 10002/3



## DEPARTMENT OF ELECTRONICS AND COMMUNICATION ENGINEERING

ADD ON COURSE NAME: Modern Chip Design and Its Applications

DAY WISE ATTENDANCE SHEET

Academic Year : 2021-2022

Date : 27-10-2021

B.Tech IV-I SEM

SECTION : ECE-B

S.No	Roll Number	27-10-21	28-10-21	29-10-21	30-10-21
1	18UPIA0454	A-y	A-y	A-y	A-y
2	18UPIA0455	Gay	Gay	Gay	Gay
3	18UPIA0456	Gay	Gay	Gay	Gay
4	18UPIA0457	Sai Priya	Sai Ashritha	Sai Priya	Sai Ashritha
5	18UPIA0458	Sai Ashritha	Sai Ashritha	AB	Sai Ashritha
6	18UPIA0459	Abhiga	Abhiga	Abhiga	Abhiga
7	18UPIA0460	venkata Gay	venkata Gay	venkata Gay	venkata Gay
8	18UPIA0461	Likitha	Likitha	Likitha	Likitha
9	18UPIA0462	Kavya free	Kavya free	Kavya free	Kavya free
10	18UPIA0463	Bha	Bha	Bha	Bha
11	18UPIA0464	Teja	Teja	Teja	Teja
12	18UPIA0465	Wanya	Wanya	Wanya	Wanya
13	18UPIA0466	G. lakshmi	G. lakshmi	G. lakshmi	G. lakshmi
14	18UPIA0468	Prat	Prat	Prat	Prat
15	18UPIA0469	Kaesthi	Kaesthi	Kaesthi	Kaesthi
16	18UPIA0471	Pooja	Pooja	Pooja	Pooja
17	18UPIA0472	Divya	Divya	Divya	Divya
18	18UPIA0473	Rupa	Rupa	Rupa	Rupa
19	18UPIA0474	Snigdha	Snigdha	Snigdha	Snigdha
20	18UPIA0475	k.Bhavana	k.Bhavana	k.Bhavana	k.Bhavana
21	18UPIA0476	Sa	Sa	Sa	Sa
22	18UPIA0477	Sath	Sath	Sath	Sath
23	18UPIA0478	shaesta	shaesta	shaesta	shaesta
24	18UPIA0479	At	At	At	At
25	18UPIA0480	vasantha	vasantha	vasantha	vasantha
26	18UPIA0481	Lakshmi	Lakshmi	Lakshmi	Lakshmi
27	18UPIA0482	varshithe	Varshithe	varshithe	varshithe
28	18UPIA0483	Sa	Sa	Sa	Sa
29	18UPIA0486	Vis	Vis	Vis	Vis



  
PRINCIPAL

Vignans Institute of Management & Technology for Women  
Kondapur(V), Ghatkesar(M), Medchal-Malkajgiri(D)-501301  
Telangana State

30	18UPIA0487	varshitha	varshitha	varshitha	varshitha	varshitha
31	18UPIA0488	Ru	Ru	Ru	Ru	Ru
32	18UPIA0489	Ru	Ru	Ru	Ru	Ru
33	18UPIA0491	P. Harini	P. Harini	P. Harini	P. Harini	P. Harini
34	18UPIA0492	Armitha	Armitha	Armitha	Armitha	Armitha
35	18UPIA0493	Madhumitha	Madhumitha	Madhumitha	Madhumitha	Madhumitha
36	18UPIA0494	Sravani	Sravani	Sravani	Sravani	Sravani
37	18UPIA0495	Pranayati	Pranayati	Pranayati	Pranayati	Pranayati
38	18UPIA0496	SI	SI	SI	SI	SI
39	18UPIA0497	NAVYASRI	NAVYASRI	NAVYASRI	NAVYASRI	NAVYASRI
40	18UPIA0498	Sravya	Sravya	Sravya	Sravya	Sravya
41	18UPIA0499	Srinthu	Srinthu	Srinthu	Srinthu	Srinthu
42	18UPIA04A0	Madhu	Madhu	Madhu	Madhu	Madhu
43	18UPIA04A2	Deepa	Deepa	Deepa	Deepa	Deepa
44	18UPIA04A3	Sushmitha	Sushmitha	Sushmitha	Sushmitha	Sushmitha
45	19UP5A0408	Renuka	Renuka	Renuka	Renuka	Renuka
46	19UP5A0409	Ilana	Ilana	Ilana	Ilana	Ilana
47	19UP5A0410	SHRISHA	SHRISHA	SHRISHA	AB	SHRISHA
48	19UP5A0411	Sindhu	Sindhu	Sindhu	Sindhu	Sindhu
49	19UP5A0413	Akhila	Akhila	Akhila	Akhila	Akhila
50	19UP5A0414	Asha	Asha	Asha	Asha	Asha

  
COORDINATOR

  
HOD

Head of the Department  
Electronic and Communication Engineering  
Vignans Institute of Management & Technology For Women  
Kondapur (V), Ghatakesar (M), Medchal-Malkajgiri (D)-501301  
Telangana State



  
PRINCIPAL  
Vignans Institute of Management & Technology For Women  
Kondapur(V), Ghatakesar(M), Medchal-Malkajgiri(D)-501301  
Telangana State



## DEPARTMENT OF ELECTRONICS AND COMMUNICATION ENGINEERING

Date: 02 -11- 2021

### PROGRAM REPORT

**Name of the Add on Course:** Modern Chip Design and Its Applications

**Day/Duration:** 33 hours

**Time:** 100

**Resource Person:** Mr. Ranveer Singh, Truechip Pvt. Ltd. Hyderabad

**Name of the Coordinator:** Mr.T.Pullaiah, Associate Professor, VMTW, Hyderabad

**Number of the Participants:**100

**Topics covered:** The following topics covered in this program

- ❖ Fabrications of ICs
- ❖ MOS/CMOS/BiCMOS

#### **Course Outcomes:**

COs	At the end of the course, students will have the ability to:	Pos Mapped	Strength of mapping
CO1	To Learn basic programmable logic devices and testing of CMOS circuits	PO2,PO4	2
CO2	To Understand the electrical properties of MOS and BiCMOS devices	PO3,PO5	3
CO3	Give exposure to different steps involved in the fabrication of ICs	PO2,PO4,PO7	2
CO4	Understand basic programmable logic devices and testing of CMOS circuits	PO3,PO5	3

**Assessment Procedure:** The assessment of the Add on course is conducted in Multiple Choice Questions through offline Mode.



*(Signature)*  
**PRINCIPAL**  
 Vignans Institute of Management & Technology For w...  
 Kondapur(V), Ghatkesar(M), Medchal-Malkajgiri(D)-501301  
 Telangana State

*(Signature)*  
**HOD**  
 Head of the Department  
 Electronics and Communication Engineer...  
 Vignans Institute of Management & Technology For...  
 Kondapur (V), Ghatkesar (M), Medchal-Malkajgiri (D)-501301



# VIGNAN'S INSTITUTE OF MANAGEMENT AND TECHNOLOGY FOR WOMEN

(Sponsored by Lavu Educational Society)

Approved by AICTE, New Delhi & Affiliated to JNTUH, Hyderabad.

Kondapur (V), Ghatkesar (M), Medchal - Malkajgiri (D) - 501 301



## CERTIFICATE OF COURSE COMPLETION

*This certificate is presented to*

SAMALA POOJA

*for her completion of an Add-on course on*

**"MODERN CHIP DESIGN AND ITS APPLICATIONS"** held from

**13<sup>TH</sup> SEPTEMBER to 30<sup>TH</sup> OCTOBER, 2021**, Organized by the

*Department of Electronics and Communication Engineering,*

*In association with Truechip, Noida.*

  
Co-ordinator



  
HoD, ECE

Head of the Department

  
PRINCIPAL  
Vignans Institute of Management & Technology For Women  
Kondapur(V), Ghatkesar(M), Medchal-Malkajgiri(Dt)-501301  
Telangana State

  
Principal, VMTW  
PRINCIPAL



DEPARTMENT OF ELECTRONICS AND COMMUNICATION ENGINEERING

VMTW/ECE/WS/CIR/2020-21/2/1

Date: 10-09-2020.

**CIRCULAR**

This is to inform all the IV B. Tech ECE students that there will be a Workshop on entitled "The Integrated Circuit Design – How do integrated circuit works and how it is made "in association with True Chip Solutions Pvt. Ltd by Mr.S.Rajeev Patnaik, from 14-09-2020 to 15-09-2020.

All students are invited to take part in this Workshop. The participating students will be honored with certificates of participation.

During the Workshop you will be encouraged to interact with the speaker and the other participants through the case study discussions.

  
HOD

Copy to:

The Principal, for kind information

IQAC

Dept. File

Circular to IV ECE Class Rooms



  
PRINCIPAL  
Vignan's Institute of Management & Technology For  
Women  
Kondapur(V), Ghatkesar(M), Medchal-Malkajgiri(D)  
Telangana State

Request to conduct a workshop in our college

Dept. of ECE VMTW <ece@vmtw.in>

To: rajivpatnaikindia@gmail.com>

Mon September, 7th, 2020 at 12:00 PM

Respected sir,

I am Mr. Vijaykumar Rewnath Urkude, HOD, Dept of ECE, Vignan's Institute Of Management And Technology For Women, Ghatkesar, Hyderabad, Telangana. We are planning to conduct a two day workshop on "The Integrated Circuit Design - How do integrated circuit works and how it is made" on 14<sup>th</sup> and 15<sup>th</sup> September 2020 to enhance the knowledge of the students. I request to send approval for conducting workshop

Thanking you

Thanks Regards  
Vijaykumar Rewnath Urkude  
Assoc. Prof & HOD,  
Dept. of ECE, VMTW  
Contact: 92937 93986



  
PRINCIPAL  
Vignan's Institute of Management & Technology For Women  
Kondapur(V), Ghatkesar(M), Medchal-Malkajgiri(D),  
Telangana State



Regarding work shop approval

rajivpatnaikindia@gmail.com>

08, September, 2020 at 10:02 AM

To: Dept. of ECE VMTW <ece@vmtw.in>

Sir/Madam,

Sub: approved for organizing workshop

Hence further enhancement of student's knowledge we have approved the organization to conduct a two day workshop on "The Integrated Circuit Design - How do integrated circuit works and how it is made".

With Regards,  
Mr. S. Rajeev Patnaik,  
True Chip Solutions Pvt.Ltd ,  
Lajpat Nagar ,  
New Delhi.



*ASH*  
PRINCIPAL  
Vignans Institute of Management & Technology For Women  
Kondapur (M), Chaitanya (B), Madhav Nagar (D), Pal-501301  
Telangana State

## REGISTRATION FORM

Name: .....

Date of Birth & Age: .....

Gender (M/F): .....

Qualifications: .....

Institution: .....

Affiliating University: .....

Address for Communication: .....

Phone Nos. ....

Office: .....

Personal: .....

Email: .....

Resource Person:  
**Mr. S. Rajeev Patnaik,**  
Truechip Solutions,  
Noida.

Chief-patrons:  
**Dr. L. Rathaiah,**  
Chairman,  
Vignan Group of Institutions.

**Mr. B. Shravan,**  
Chief Executive Officer,  
Vignan Group of Institutions

Patron:  
**Dr. G. Apparao Naidu,**  
Principal, VMTW

**Mr. Vijaykumar Rewnath Urkude**  
Associate Professor & Head of the Department,  
Dept. of ECE.

Co-ordinator:  
**Mrs. Anusha Pinisetty**  
Assistant Professor, Dept. of ECE,  
Contact No: +91 89856 41544

Student Co-ordinator:  
**Ms. Nakka Yamini**  
Contact No: +91 93472 10696

**Ms. Y. Shamili**  
Contact No: +91 97003 44949

**PRINCIPAL**  
Vignan's Institute of Management & Technology For Women  
Kondapur(V), Ghatkesar(M), Medchal-Malkajgiri (D) - 501 301  
Tel: 011-26101111  
[www.vmtw.in](http://www.vmtw.in)

 **VIGNAN'S**   
**INSTITUTE OF MANAGEMENT AND  
TECHNOLOGY FOR WOMEN**

(Sponsored by Law Educational Society)  
Approved by AICTE, New Delhi & Affiliated to JNTUH, Hyderabad.  
Kondapur (V), Ghatkesar (M), Medchal - Malkajgiri (D) - 501 301



A TWO DAY WORKSHOP ON  
**THE INTEGRATED  
CIRCUIT DESIGN**  
HOW DO INTEGRATED CIRCUIT  
WORKS AND HOW IT IS MADE?  
14<sup>TH</sup> & 15<sup>TH</sup> SEPTEMBER, 2020

VENUE:  
**'B'-BLOCK SEMINAR HALL, VMTW**

ORGANIZED BY:  
**DEPARTMENT OF ELECTRONICS AND  
COMMUNICATION ENGINEERING**



LAST DATE FOR REGISTRATION: 12<sup>TH</sup> SEPTEMBER, 2020

## ABOUT THE INSTITUTION

Vignan's Institute of Management and Technology for Women (VMTW), is the brainchild of Dr. L. Rathalah, Chairman, Vignan Group of Institutions, which was founded in August 2008, with four branches of Engineering.

VMTW is an exemplary institution of higher learning with a mission of pursuing excellence in education and research. The institution, with its diverse and dynamic community of about 2000 students offers a distinctive combination of some of the finest facilities for 7 different graduate, and undergraduate programs, accomplished faculty, world-class facilities with a hostel set on a sprawling area of 22 acres with lush surroundings of mango groves and greenery.

While students at VMTW immerse themselves in academics, the college has a lot in store for them outside the classroom. Student life includes participation in sports, recreational & extra-curricular, and cultural activities. In short, at VMTW students will find an academic and social environment where everyone from faculty members to peers helps shape their future.

VMTW is a home to aesthetically designed buildings with state-of-the-art computer and internet facilities, modern laboratories, workshops, seminar halls, auditoriums, and well-stocked libraries, sports, and games fields.

The Institution boasts of a strong alumni network with alumni events held every year serving as a platform for past students to give back to VMTW and share their experiences with their present fellow students. With so much to offer, it is only natural that students of VMTW get a unique opportunity to carve a niche for themselves in their chosen field of study that enables them to become well-rounded and discerning professionals, fully qualified for their chosen professions in the workplace. Institute also brings out the creativity in students by imparting engineering knowledge imbuing interpersonal skills to promote innovation, research, and entrepreneurship.

## ABOUT THE DEPARTMENT

Department of Electronics and Communication Engineering was started since the inception of Vignan's Institute of Management and Technology for Women during 2008 with an initial intake of 90. The strength was enhanced to 120 during 2010. The Department had added Post graduate programme in VLSI during the year 2011 and Embedded Systems during 2014 with an intake of 18 each.

The Department has state-of-art laboratories equipped with advanced and well maintained equipment, continuously updated application software packages, more than adequate computing systems with 24x7, 30 MBPS internet facility.

## ABOUT THE COURSE

Integrated circuits revolutionized electronics and computing during the 1960s and 1970s. First, engineers were putting dozens of components on a chip in what was called Small-Scale Integration (SSI). Medium-Scale Integration (MSI) soon followed, with hundreds of components in an area of the same size. Predictably, around 1970, Large-Scale Integration (LSI) brought thousands of components, Very-Large-Scale Integration (VLSI) gave us tens of thousands, and Ultra Large Scale (ULSI) millions—and all on chips no bigger than they'd been before. In 1965, Gordon Moore of the Intel Company, a leading chipmaker, noticed that the number of components on a chip was doubling roughly every one to two years.

## COURSE OBJECTIVES

Moore's Law, as this is known, has continued to hold ever since. Interviewed by The New York Times 50 years later, in 2015, Moore revealed his astonishment that the law has continued to hold: "The original prediction was to look at 10 years, which I thought was a stretch. This was going from about 60 elements on an integrated circuit to 60,000—a thousandfold extrapolation over 10 years. I thought that was pretty wild. The fact that something similar is going on for 50 years is truly amazing."

## EXPECTED OUTCOMES

At the end of Workshop, participants will be able to

- How Integrated Circuit Components are Formed
- Design Process.
- Raw Materials information.
- The Manufacturing Process.



PRINCIPAL

Vignan's Institute of Management & Technology for Women  
Kondapur(V), Ghatkesar(M), Medchal-Malkajgiri(Dt)-501301  
Telangana State



# VIGNAN'S INSTITUTE OF MANAGEMENT AND TECHNOLOGY FOR WOMEN

Sponsored by Lavu Educational Society, Approved by AICTE, New Delhi & Affiliated to JNTUH, Hyderabad.  
Kondapur (V), Ghatkesar (M), Medchal - Malkajgiri (D) - 501 301 Phone: +91 96529 10002/3



## WORKSHOP ON



### THE INTEGRATED CIRCUIT DESIGN

# HOW DO INTEGRATED CIRCUIT WORKS AND HOW IT IS MADE

## 14<sup>TH</sup> & 15<sup>TH</sup> SEPTEMBER, 2020

### DEPARTMENT OF ELECTRONICS AND COMMUNICATION ENGINEERING



*Handwritten signature*  
Vignan's Institute of Management and Technology  
Kondapur (V), Ghatkesar (M), Medchal - Malkajgiri (D) - 501 301  
Telangana State



# VIGNAN'S INSTITUTE OF MANAGEMENT AND TECHNOLOGY FOR WOMEN

(Sponsored by Lawu Educational Society)

Approved by AICTE, New Delhi & Affiliated to JNTUH, Hyderabad.

Kondapur (V), Ghatkesar (M), Medchal - Malkajgiri (D) - 501 301



## CERTIFICATE OF PARTICIPATION



This certificate is presented to

.....

for her participation in a Two Day Workshop on

"The Integrated Circuit Design - How do integrated circuit works and how it is made"

held from 14-09-2020 to 15-09-2020

Organized by the Department of Electronics and Communication Engineering.

Coordinator



HoD, ECE

*[Signature]*  
Principal

Principal

Vignans Institute of Management & Technology, E.C. Block



Vignana's Institute Of Management and Technology For Women  
Work shop on "The Integrated Circuit Design - How do integrated circuit works  
and how it is made"



IV B.Tech I sem Students List-2020-21

Branch :ECE-A

S. No	Hall Ticket No	Student Name	Sign of the student- 14/09/20	Sign of the student- 15/09/20
1	16UP1A0488	SANALA SWARNA SRI	Swarna	Swarna
2	17UP1A0401	ANUMOJU SRAVANI	Anumaju	Anumaju
3	17UP1A0402	ATUKURI VIGNESHWARI	Vigneshwari	Vigneshwari
4	17UP1A0403	BABIREDDY NAINIKA REDDY	B. Nainika	B. Nainika
5	17UP1A0404	BASHETTI PRAVALIKA	Pravalika	Pravalika
6	17UP1A0405	BERE YASHASWINI	B. Yashaswini	B. Yashaswini
7	17UP1A0406	BONTHU RAMYA	Ramya	Ramya
8	17UP1A0407	CH DHARANI	Dharani	Dharani
9	17UP1A0408	CHEEMALA MOUNIKA	C. Mounika	C. Mounika
10	17UP1A0409	CHILUKA KAVYA SRI	Kavya	Kavya
11	17UP1A0410	CHINTAMKAR SAIPRIYA	Saipriya	Saipriya
12	17UP1A0411	CHINTHA BHAVITHA	Bhavitha	Bhavitha
13	17UP1A0412	CHOKKAM DIVYA	C. Divya	C. Divya
14	17UP1A0413	DHARNABOINA ARCHANA	Archana	Archana
15	17UP1A0414	ELLENDULA VAISHANAVI	Vishnavi	Vishnavi
16	17UP1A0415	GOURLA SWETHA	Swetha	Swetha
17	17UP1A0416	JAKKULA BHUVI AKARSHA	Bhuvika	Bhuvika
18	17UP1A0417	K AKANKSHA REDDY	K. Akanksha	K. Akanksha
19	17UP1A0418	KALYANKAR HARIPRIYA	Hari	Hari
20	17UP1A0419	KODURU SOWMYA	Sowmya	Sowmya
21	17UP1A0420	KULSUM KHKNAM NAYYAR	Kulsum	Kulsum
22	17UP1A0421	KUNCHUPU JAHNAVI	Jahnavi	Jahnavi
23	17UP1A0422	M SRAVANTHI	Sravanthi	Sravanthi
24	17UP1A0423	M SREEJA	Sreeja	Sreeja
25	17UP1A0424	MAHESHWARAM PRAVALIKA	Pravalika	Pravalika
26	17UP1A0425	MANISHA MUTTAVARAPU	Manisha	Manisha
27	17UP1A0426	MODUGU MANISHA	Manisha	Manisha
28	17UP1A0427	GOTTIUMUKKULA	Gottiumukkula	Gottiumukkula
29	17UP1A0428	NALLAM ANJANA SRIVENI	Sriveni	Sriveni



PRINCIPAL

Vignana's Institute of Management & Technology For Women  
Kondapur(V), Ghatkesar(M), Medchal-Malkajgiri(DI)-501301  
Telangana State

30	17UP1A0429	NANDIGAMA NAVYA	Nef	Nef
31	17UP1A0430	P NANDINI	N	N
32	17UP1A0431	PABBATHI PRIYANKA	Priyanka	Priyanka
33	17UP1A0432	PAGALA RAMYA	Ramyas	Ramyas
34	17UP1A0433	PALADUGU SANDHYA	Sandhya	Sandhya
35	17UP1A0435	PASHAM SHIVANI REDDY	Reddy	Reddy
36	17UP1A0436	PATURI MANUSHA	AS	AS
37	17UP1A0437	POLAGANI BHARGAVI	B	B
38	17UP1A0438	POLICE PREETHI	Preethi	Preethi
39	17UP1A0439	POTALA SRAVYASRI	Sravysri	Sravysri
40	17UP1A0440	POTLAPALLI DHARANI	Dharani	Dharani
41	17UP1A0442	PUNDRU KEERTHANA	P. Keethana	P. Keethana
42	17UP1A0443	PUSULLURI VASANTHI REDDY	Vas	Vas
43	17UP1A0444	R SUBHIKSHA	Subhiksha	Subhiksha
44	17UP1A0445	RACHABATTULA PRANAVA	R. Pranava	R. Pranava
45	17UP1A0446	RAMADASU SUSHMITHA	sushmitha	sushmitha
46	17UP1A0447	S TEJA	Teja	Teja
47	17UP1A0448	SUNKARI SOUMYA	S. Soumya	S. Soumya
48	17UP1A0449	TUNGATURTI YASASWI SOWMYA	sowmya	sowmya
49	17UP1A0450	UDUTHALA SHIVANI	AS	AS
50	17UP1A0451	VAKITI SHIRISHA	S	S
51	17UP1A0452	VEMIREDDY RAMYASREE	V. Ramyasree	V. Ramyasree

*[Signature]*  
COORDINATOR

*[Signature]*  
HOD,ECE

Head of the Department  
Date: \_\_\_\_\_  
Signature of the Head of the Department  
Name of the Head of the Department: \_\_\_\_\_



*[Signature]*  
**PRINCIPAL**  
Vignana Institute of Management & Technology for Women  
Kondapur(V), Ghettibara(S), Medchal-Malkajgiri(DT)-501 101  
Telangana State



Vignan's Institute Of Management and Technology For Women

Work shop on "The Integrated Circuit Design - How do integrated circuit works and how it is made"



IV B.Tech I sem Students List-2020-21

Branch :ECE-B

S. No	Hall Ticket No	Student Name	Sign of the student- 14/09/20	Sign of the student- 15/09/20
1	17UP1A0454	ANKAPURAM VARSHA	Vy	Vy
2	17UP1A0455	AYESHA NAFEEZ	Ay	Ay
3	17UP1A0456	BADDAM SANGEETHA	Sangeetha	Sangeetha
4	17UP1A0457	BATHINI UDHAYASRI	Udhay	Udhay
5	17UP1A0458	BEERAVALLI GEETHA CHANDANA	Geetha	Geetha
6	17UP1A0459	CHAMA HARINI	Harini	Harini
7	17UP1A0460	CHILUKURI ANJALI	Anjali	Anjali
8	17UP1A0461	CHITYALA HIMAJA	Himaja	Himaja
9	17UP1A0462	DODDA NIHARIKA	Niharika	Niharika
10	17UP1A0463	GOTTUMUKULA PRANITHA	Pranitha	Pranitha
11	17UP1A0464	GUDIPATHI PRANITHA	Pranitha	Pranitha
12	17UP1A0465	GURRALA VENKATAKRISHNAVENI	Venka	Venka
13	17UP1A0466	KESARA SUCHARITHA	Suchi	Suchi
14	17UP1A0467	KOMATIREDDY JHANSI	Jhansi	Jhansi
15	17UP1A0468	KONDA SANJANA	Sanj	Sanj
16	17UP1A0469	KONDURU HARSHITHA	Harshitha	Harshitha
17	17UP1A0470	KUDIDHI SUSHMA	Sush	Sush
18	17UP1A0471	KUKKADAPU PRAVALLIKA	Pravalika	Pravalika
19	17UP1A0472	MADDIRALA VASAVI	Vasavi	Vasavi
20	17UP1A0473	MAHENDRAKAR RACHANA	Rachana	Rachana
21	17UP1A0474	MAMILLAPALLY MOUNIKA	Mounika	Mounika
22	17UP1A0475	MUKUNDU MOUNIKA	Mounika	Mounika
23	17UP1A0476	MUSHNAM REVATHI	Revathi	Revathi
24	17UP1A0477	NACHU CHAITRA	Chaitra	Chaitra
25	17UP1A0478	PAILLA SNEHA	Sneha	Sneha
26	17UP1A0479	PANJALA HIMA SANTOSHINI	Santoshini	Santoshini
27	17UP1A0480	PATLOLLA AKHILA	Akhila	Akhila
28	17UP1A0481	PEDDAMAGARI SWATHI	Swathi	Swathi
29	17UP1A0482	POLNEEDI KAVYA SRI	Kavya	Kavya
30	17UP1A0483	PREETHIKA	Preethika	Preethika
31	17UP1A0484	PUCHAKAYALA SATWIKA	Satwika	Satwika
32	17UP1A0485	PULLURI MADHURI	Madhuri	Madhuri
33	17UP1A0486	R INDUMANI	Indu	Indu
34	17UP1A0487	R VANI	Vani	Vani
35	17UP1A0488	RAMANAKOL PRIYANKA	Priyanka	Priyanka
36	17UP1A0489	SHYAM REDDY VARSHA	Varsha	Varsha
37	17UP1A0490	SINGIDI PUJITHA	Pujitha	Pujitha
38	17UP1A0491	SIRAPANGI KEERTHY EVANGELINE	Keerthy	Keerthy
39	17UP1A0493	SODHA ANUSHA	Anusha	Anusha



*[Signature]*  
PRINCIPAL

Vignan's Institute of Management & Technology For Women  
Gandepur(V), Ghatkesar(N), Medchal-Malkajgiri(Dr...)  
Telangana State



40	17UP1A0494	SRIKAKOLLAPU AMRUTHA VARSHINI	AM	AM
41	17UP1A0495	SUKKA SAHITHI	S. Sahithi	S. Sahithi
42	17UP1A0496	TELU NIKITHA	T. Nikitha	T. Nikitha
43	17UP1A0497	THAGIRA SAI PRIYA	Sai	Sai
44	17UP1A0498	UPPULURI SHYAMALA SESHADRI	Shyama	Shyama
45	17UP1A0499	VAVILIKOLANU CHANDANA	Chandana	Chandana
46	17UP1A04A0	VEERAMALLA PRATHYUSHA	Prathyusha	Prathyusha
47	17UP1A04A1	VELMA VYSHNAVI REDDY	Vyshnavi	Vyshnavi
48	18UP5A0401	BUSHABOINA SHRAYYA	Shrayya	Shrayya
49	18UP5A0402	HAFSA SUBHI	Subhi	Subhi
50	18UP5A0403	KORNI MADHAVI	M	M

*[Signature]*  
COORDINATOR

*[Signature]*  
BOD, ECE

Electronics & Communication Engineering  
Vignans Institute of Management & Technology  
Kondapur (V), Medchal (M), Medchal-Malkajgiri (D) - 501202



*[Signature]*  
PRINCIPAL  
Vignans Institute of Management & Technology For Women  
Kondapur (V), Medchal (M), Medchal-Malkajgiri (D) - 501202  
Telangana State



VIGNAN'S INSTITUTE OF MANAGEMENT AND  
TECHNOLOGY FOR WOMEN

Kondapur (V), Ghatkesar (M), Medchal. Dist – 501 301.



DEPARTMENT OF ELECTRONICS AND COMMUNICATION ENGINEERING

Date: 18-09-2020

Conclusion report on "The Integrated Circuit Design - How do integrated circuit works and how it is made"

**Sub:** conclusion Report of "How do integrated circuit works and how it is made" conducted on 14<sup>th</sup> & 15<sup>th</sup> September, 2020—reg.

The workshop was aimed to provide knowledge about Integrated circuits Mr. S. Rajeev Patnaik, True Chip Solutions Pvt. Ltd, Lajpat Nagar ,New Delhi, executed 2-days Workshop on "The Integrated Circuit Design - How do integrated circuit works and how it is made". After attending this workshop students have expressed, IC Design process , Raw Materials information ,the Manufacturing Process and applications in any Electronics Project. This workshop will be helpful for students for circuit development of their final year project. Total 95 students have participated in this workshop. The workshop was an informative and interesting. All the students of ECE had a practical exposure about the Integrated Circuit Design.

On behalf of the students I request you to arrange more workshops for students to improve the knowledge of students and enhance the career opportunities.

  
Mrs. Anusha Pinisetty

Associate Professor, ECE.

VMTW ,Ghatkesar, HYD.



  
PRINCIPAL

Vignans Institute of Management & Technology For Women

Kondapur(V), Ghatkesar (M), Medchal, Malakpet (M), Dist-501301

Kondapur (V), Ghatkesar (M), Medchal, Malakpet (M), Dist-501301

Telangana State



DEPARTMENT OF ELECTRONICS AND COMMUNICATION ENGINEERING

VMTW/ECE/WS/CIR/2021-22/1/1

Date: 01-11-2021

**CIRCULAR**

This is to inform all the II B.Tech ECE Students that there will be a Workshop on entitled "Understanding Rectangular Waveguides" in Association with True Chip Solutions Pvt. Ltd, Lajpat Nagar, and New Delhi by Mr. S. Rajeev Patnaik from 05-11-2021 to 06-11-2021 at B- Block Seminar Hall. All students are invited to take part in this Workshop. The participating students will be honored with certificates of participation.

During the Workshop you will be encouraged to interact with the speaker and the other participants through the case study discussions.

  
HOD

Copy to:

The Principal, for kind information

IQAC

Dept. File

Circular to II ECE Class Room



  
PRINCIPAL  
Vignans Institute of Management & Technology For Women  
Kondapur(V), Ghatkesar(M), Medchal-Malkajgiri(D)-501301  
Telangana State



# Request to conduct a workshop in our college

< rajivpatnaikindia@gmail.com >

Dept. of ECE VMTW <ece@vmtw.in>

To: < rajivpatnaikindia@gmail.com >

Thu October, 25th, 2021 at 12:54 PM

Respected sir,

I am Mr. P.Harikrishna, HOD, Dept of ECE, Vignan's Institute Of Management And Technology For Women, Ghatkesar Hyderabad, Telangana. We are planning to conduct a two day workshop on "Understanding Rectangular Waveguides" on 5<sup>th</sup> and 6<sup>th</sup> November 2021 to enhance the knowledge of the students. I request to send approval for conducting workshop

Thanking you

Thanks Regards  
P.Harikrishna  
Assoc. Prof & HOD,  
Dept. of ECE, VMTW  
Contact: 7093246048



PRINCIPAL  
Vignan's Institute of Management & Technology For Women  
Kondapur(V), Ghatkesar(M), Medchal-Malkajgiri(D), Telangana State

Regarding work shop approval

< rajivpatnaikindia@gmail.com >

26<sup>th</sup> ,October, 2021 at 02:22 PM

To: Dept. of ECE VMTW <ece@vmtw.in>

Sir/Madam,

Sub: approved for organizing workshop

Hence further enhancement of students knowledge we have approved the organization to conduct a two day workshop on "Understanding Rectangular Waveguides".

With Regards,  
Mr. S. Rajeev Patnaik,  
True Chip Solutions Pvt.Ltd ,  
Lajpat Nagar ,  
New Delhi.



  
**PRINCIPAL**  
Vignans Institute of Management & Technology for Women  
Kondapur(V), Ghatkeer(M), Medchal-Malkajgiri(D), Telangana State

# REGISTRATION FORM

Name: .....

Date of Birth & Age: .....

Gender (M/F): .....

Qualifications: .....

Institution: .....

Affiliating University: .....

Address for Communication: .....

Phone Nos. .....

Mobile: .....

Personal: .....

Email: .....

LAST DATE FOR REGISTRATION: 3<sup>RD</sup> NOVEMBER, 2022

Resource Person:  
**Dr. S. Rajeev Patnaik,**  
Truechip Solutions,  
Noida.

Chief-patrons:  
**Dr. L. Rathaiah,**  
Chairman,  
Vignan Group of Institutions.

**Mr. B. Shravan,**  
Chief Executive Officer,  
Vignan Group of Institutions

Patron:  
**Dr. G. Apparao Naidu,**  
Principal, VMTW

**Mr. P. Harikrishna,**  
Associate Professor & Head of the Department,  
Dept. of ECE.

Co-ordinator:  
**Mrs. Swathi Gangula**  
Assistant Professor, Dept. of ECE,  
Contact No: +91 90105 13351

Student Co-ordinator:  
**Ms. Goka Anusha**  
Contact No: +91 76010 85947

**Ms. S. Akshaya**  
Contact No: +91 89195 31726

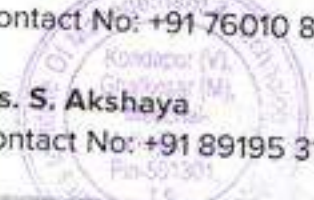

**PRINCIPAL**  
Vignan's Institute of Management & Technology for Women  
Kondapur (V), Ghatkesar (M), Medchal - Malkajgiri (D)

[www.vmtw.in](http://www.vmtw.in)

# VIGNAN'S INSTITUTE OF MANAGEMENT AND TECHNOLOGY FOR WOMEN

(Sponsored by Law Education Society)  
Approved by AICTE, New Delhi & Affiliated to JNTUH, Hyderabad.  
Kondapur (V), Ghatkesar (M), Medchal - Malkajgiri (D) - 501 30



## A TWO DAY WORKSHOP ON "UNDERSTANDING RECTANGULAR WAVEGUIDES" 5<sup>TH</sup> & 6<sup>TH</sup> NOVEMBER, 2021

VENUE:  
**'B'-BLOCK SEMINAR HALL, VMTW**

ORGANIZED BY:  
**DEPARTMENT OF ELECTRONICS AND  
COMMUNICATION ENGINEERING**



## ABOUT THE INSTITUTION

Vignan's Institute of Management and Technology for Women (VMTW), is the brainchild of Dr. L. Rathaiah, Chairman, Vignan Group of Institutions, which was founded in August 2008, with four branches of Engineering.

VMTW is an exemplary institution of higher learning with a mission of pursuing excellence in education and research. The institution, with its diverse and dynamic community of about 2000 students offers a distinctive combination of some of the finest facilities for 7 different graduate, and undergraduate programs, accomplished faculty, world-class facilities with a hostel set on a sprawling area of 22 acres sylvan surroundings of mango groves and greenery.

While students at VMTW immerse themselves in academics, the college has a lot in store for them outside the classroom. Student life includes participation in sports, recreational & co-curricular, and cultural activities. In short, at VMTW students will find an academic and social environment here everyone from faculty members to peers helps shape their future.

VMTW is a home to aesthetically designed buildings with state-of-the-art computer and internet facilities, modern laboratories, workshops, seminar halls, auditoriums, and well-stocked libraries, sports, and games fields.

The Institution boasts of a strong alumni network with alumni events held every year serving as a platform for past students to give back to VMTW and share their experiences with its present fellow students. With so much to offer, it is only natural that students of VMTW get a unique opportunity to carve a niche for themselves in their chosen field of study that enables them to become well-rounded and discerning professionals, fully qualified for their chosen professions in the workplace. Institute also brings out the creativity in students by imparting engineering knowledge imbining personal skills to promote innovation, research, and entrepreneurship.

## ABOUT THE DEPARTMENT

Department of Electronics and Communication Engineering was started since the inception of Vignan's Institute of Management and Technology for Women during 2008 with an initial intake of 90. The strength was enhanced to 120 during 2010. The Department had added Post graduate programme in VLSI during the year 2011 and Embedded Systems during 2014 with an intake of 18 each.

The Department has state-of-art laboratories equipped with advanced and well maintained equipment, continuously updated application software packages, more than adequate computing systems with 24x7, 30 MBPS internet facility.

## ABOUT THE COURSE

In electromagnetic, a waveguide confines electromagnetic signals within the structure, preventing spreading, losses, and signal transmission from one point to another. Usually, a basic waveguide can be constructed from a hollow conducting tube. If the conducting tube has a rectangular cross-section, then it forms the rectangular waveguide. In the section below, we will discuss various aspects of rectangular waveguide theory.

## COURSE OBJECTIVES

Rectangular waveguides are the most commonly used waveguides. They consist of a hollow metallic structure with a rectangular cross-section. A rectangular waveguide is usually constructed with a length of  $a > b$ , where  $b$  is the breadth of the rectangle. A common trend for the dimension of a rectangular waveguide is  $a = 2b$ .

## EXPECTED OUTCOMES

At the end of Workshop, participants will be able to

- Usually, a basic waveguide can be constructed from a hollow conducting tube. If the conducting tube is rectangular in shape, then it forms a rectangular waveguide.
- Rectangular waveguides are extensively used in radars, couplers, isolators, and attenuators to transmit signals.
- The electromagnetic fields corresponding to  $(m, n)$  are called  $TE_{mn}$  mode. The  $TE_{10}$  mode is the dominant waveguide in rectangular waveguides.

  
PRINCIPAL

Vignan's Institute of Management & Technology For Women  
Ghatewada (M), Medchal-Malkajgiri (DT)-501 202,  
Telangana State



# VIGNAN'S INSTITUTE OF MANAGEMENT AND TECHNOLOGY FOR WOMEN

Sponsored by Lavu Educational Society, Approved by AICTE, New Delhi & Affiliated to JNTUH, Hyderabad.  
Kondapur (V), Ghatkesar (M), Medchal - Malkajgiri (D) - 501 301 Phone: +91 96529 10002/3



## WORKSHOP ON

# UNDERSTANDING RECTANGULAR WAVEGUIDES



## 5<sup>TH</sup> & 6<sup>TH</sup> NOVEMBER, 2021

### DEPARTMENT OF ELECTRONICS AND COMMUNICATION ENGINEERING



*[Signature]*  
PRINCIPAL  
Vignans Institute of Management & Technology  
Kondapur (V), Ghatkesar (M), Medchal - Malkajgiri (D)  
Telangana State





# VIGNAN'S INSTITUTE OF MANAGEMENT AND TECHNOLOGY FOR WOMEN

(Sponsored by Lavu Educational Society)  
Approved by AICTE, New Delhi & Affiliated to JNTUH, Hyderabad.  
Kondapur (V), Ghatkesar (M), Medchal - Malkajgiri (D) - 501 301



## CERTIFICATE OF PARTICIPATION



This certificate is presented to

.....

for her participation in a Two Day Workshop on  
"Understanding Rectangular Waveguides" held from 05-11-2021 to 06-11-2021,  
Organized by the Department of Electronics and Communication Engineering.

Coordinator



HoD, ECE

  
PRINCIPAL

Principal

Vignan's Institute of Management & Technology For Women  
Kondapur(V), Ghatkesar(M), Medchal-Malkajgiri(D)-501301  
Telangana State



Vignan's Institute Of Management and Technology For Women

Work shop on "Understanding Rectangular Waveguides"

II B.Tech II sem Students List-2021-22

Branch :ECE-A



S. No	Hall Ticket No	Student Name	Sign of the student 05/11/21	Sign of the student 06/10/21
1	20PQ1A0426	LAHARI	Lahari	Lahari
2	20UP1A0401	ALAGALA SHIVANI	Shivani	Shivani
3	20UP1A0402	ANNAM ALEKHYA	Alekhyia	Alekhyia
4	20UP1A0403	B. VEDAKSHARI	Vedakshari	Vedakshari
5	20UP1A0404	BADDIPALLY KEERTHY REDDY	Keerthy	Keerthy
6	20UP1A0405	BADEMALKE AFROZJAH	Afroz Jaha	Afroz Jaha
7	20UP1A0406	BAKARAM SRAVANTHI	Sravanthi	Sravanthi
8	20UP1A0407	BANDARI VARDHANA	Vardhana	Vardhana
9	20UP1A0408	BANDREDDY DINITHA SRI	Dinitha	Dinitha
10	20UP1A0409	BARLA PUJITHA	Pujitha	Pujitha
11	20UP1A0410	BOBBALA LAXMI PRASANNA	Laxmi	Laxmi
12	20UP1A0411	BORRA DIVYA SREE	Divya	Divya
13	20UP1A0412	CHALLAMALLA KAVERI	Kaveri	Kaveri
14	20UP1A0413	DANDEM BHUMIKA	Bhumika	Bhumika
15	20UP1A0414	DASARI AKHILA	Akhila	Akhila
16	20UP1A0415	E.PRATHUSHA	Prathusha	Prathusha
17	20UP1A0416	GUDURU NIKISHA	G.nikisha	G.nikisha
18	20UP1A0417	GUJJULA ANJALI	Anjali	Anjali
19	20UP1A0418	GUNDRY YASHASWI	Yashaswi	Yashaswi
20	20UP1A0419	KAKI SUNITHA	Sunitha	Sunitha
21	20UP1A0420	KAMATAM MANASA	Manasa	Manasa
22	20UP1A0421	KODURU SANDHYA	AB	AB
23	20UP1A0422	KOLA SAI SNIGDHA	Snigdha	Snigdha



PRINCIPAL  
Vignan's Institute of Management & Technology For Women  
Kondapur(V), Ghatkesar(M), Medchal-Malkajgiri(D)-501301  
Telangana State

24	20UP1A0423	KOMMINENI SINDHU	AB	AB
25	20UP1A0424	KONDA ALEKHYA	Alekhyia	Alekhyia
26	21UP5A0401	ADEPU SWARNREKHA	Asr	Asr
27	21UP5A0402	ANKINAPALLI MAMATHA	mamatha	mamatha
28	21UP5A0403	ASHWITHA BURLA	Ashwitha	Ashwitha
29	21UP5A0404	BETHI SAHITHI	Sahithi	Sahithi
30	21UP5A0405	C GAYATHRI	Gayathri	Gayathri
31	21UP5A0406	CHEERA NAVYA	Nal	Nal
32	21UP5A0407	DONKESHWAR MADHURI	Dmadhuri	Dmadhuri
33	21UP5A0408	DULAM MANASA	manasa	manasa
34	21UP5A0409	EMUDABOINA NANDINI	nandini	nandini
35	21UP5A0410	GANNOJU OJASVI	Ojasvi	Ojasvi
36	21UP5A0411	GIDDALA BHARGAVI	Bhargavi	Bhargavi
37	21UP5A0412	LUNAVATH SHRAVANI	Shr	Shr
38	21UP5A0413	MACHANI MANASA	Manasa	Manasa
39	21UP5A0414	NAGAPURI NANDINI	nandini	nandini

COORDINATOR 

  
ECE.HOD



  
PRINCIPAL  
Vignana's Institute of Management & Technology for Women  
Kondapur(V), Ghatkesar(M), Medchal-Malkajgiri(Dt)-501301  
Telangana State



Vignan's Institute Of Management and Technology For Women

Work shop on "Understanding Rectangular Waveguides"

II B.Tech II sem Students List-2021-22

Branch :ECE-B



S. No	Hall Ticket No	Student Name	Sign of the student 05/11/21	Sign of the student 06/10/21
1	20UPIA0425	KUKKALA VINDYA	K. Vindya	k. Vindya
2	20UPIA0426	KURAPATI REVATHI	Revathi	Revathi
3	20UPIA0427	MATTEPU GOWRI LAKSHMI	Gowri	Gowri
4	20UPIA0428	METTU PRANITHA	Pranitha	Pranitha
5	20UPIA0429	MUDDAM SRI VARSHA REDDY	Sri	Sri
6	20UPIA0430	NAREDDY PAVANI	Pavani	Pavani
7	20UPIA0431	P. AMULYA	Amulya	Amulya
8	20UPIA0432	PASUNURI SHIVA PRIYA RAO	Priya	priya
9	20UPIA0433	PONUGOTI SINDHU	Sindhu	Sindhu
10	20UPIA0434	PULI SATYALAVANYA	Saty	Sat.
11	20UPIA0435	PULLA SRIVANI	Srivani	srivani
12	20UPIA0436	PURMA KEERTHANA	Keerthana	Keerthana
13	20UPIA0437	SIKHAKOLLU BHAVYA	Bhavya	Bhavya
14	20UPIA0438	SIVAKAVI MOUNIKA DEVI	mounika devi	mounik dev
15	20UPIA0439	TEKULA HARSHAVARDHINI	Harsh	Harsh
16	20UPIA0440	THATIKONDA RAMYA SRI	Ramya	Ramya
17	20UPIA0441	VALABHOJU MANASA	Manasa	Manasa
18	20UPIA0442	VELAGALA RENUKA	Renuka	Renuka
19	20UPIA0443	VOLETI CHANDANA	Chandana	Chandana
20	20UPIA0444	VUNDAVALLI SAI NAGA SHRESHTA	Sai	Sai
21	20UPIA0445	VUPPALA TEJASWINI REDDY	Tejaswini reddy	Tejaswini reddy
22	20UPIA0446	YARRAM VINITHA REDDY	Vinitha	Vinitha.
23	20UPIA0448	MANNEM PANCHAKSHARI	Panchakshari	Panchakshari
24	21UP5A0415	ODNALA ARCHITHA	Architha	Architha
25	21UP5A0416	PABBIREDDY JISHITHA	Jishitha	Jishitha
26	21UP5A0417	PADALA RATNA KUMARI	Ratna	Ratna
27	21UP5A0418	PAIDIMARRY HARINISUDHA	Harini	Harini
28	21UP5A0419	PEDDABALA ANUJA	P. Anuja	P. Anuja
29	21UP5A0420	POTHKANI SWETHA	P. Swetha	P. Swetha
30	21UP5A0421	R SAI SHIVANI BAI	R. Sai shivani Bai	R. Sai shivani Bai



PRINCIPAL  
Vignan's Institute of Management & Technology For Women  
Kondapur(V), Ghatkesar(M), Medchal-Markajigiri(DT)-501301  
T.S. State

31	21UP5A0422	RAMIDI NIKITHA	R. Nikitha	R. Nikitha
32	21UP5A0423	RELANGI HEMALATHA	Hest	Hest
33	21UP5A0424	S NANDINI	S.nandini	S.nandini
34	21UP5A0425	SANDENA OMSRI	OMSri	Omsri
35	21UP5A0426	SEELAM KAVYA	kavya	kavya
36	21UP5A0427	THAKKALA DEEPTHI	T. Deepthi	T. Deepthi
37	21UP5A0428	VUNGARALA POOJA PRIYA	pooja priya	pooja priya

*Jullaping*  
COORDINATOR

*[Signature]*  
ECE, HOD

Head of the Department  
Electronics and Communication Engineering  
Vignans Institute of Management & Technology  
Kondapur (V), Ghatkesar (M), Medchal-Malkajgiri (Dt)-501301



*[Signature]*

PRINCIPAL  
Vignans Institute of Management & Technology For Women  
Kondapur(V), Ghatkesar(M), Medchal-Malkajgiri(Dt)-501301  
Telangana State



**VIGNAN'S INSTITUTE OF MANAGEMENT AND  
TECHNOLOGY FOR WOMEN**

Kondapur (V), Ghatkesar (M), Medchal. Dist – 501 301.



**DEPARTMENT OF ELECTRONICS AND COMMUNICATION ENGINEERING**

Date: 08-11-2021

**Conclusion report on “Understanding Rectangular Waveguides”**

**Sub: conclusion Report of “Understanding Rectangular Waveguides”  
conducted on**

05<sup>th</sup> & 06<sup>th</sup> November, 2021—reg.

The workshop was aimed to provide knowledge about Machine Learning for Optical Communication Systems. Mr. S. Rajeev Patnaik, True Chip Solutions Pvt.Ltd, Lajpat Nagar, New Delhi, executed 2-days Workshop on “Understanding Rectangular Waveguides”. After attending this workshop students have an idea on overview on Rectangular Waveguides, applications of Rectangular Waveguides.

On behalf of the students I request you to arrange more workshops for students to improve the knowledge of students and enhance the career opportunities

Mrs.G.Swathi

Assistant Professor, ECE.

VMTW , Ghatkesar, HYD.



PRINCIPAL

Vignan's Institute of Management & Technology For Women  
Kondapur(V), Ghatkesar(M), Medchal-Meikalgiri(Dt)-501301  
Telangana State



# Industrial Visit Collaborated with CALYXPOD



PRINCIPAL

Vignan's Institute of Management & Technology For Women  
Kondapur (V), Ghatkesar (M), Medchal-Malkajgiri (D),-501301  
Telangana State



# VIGNAN'S INSTITUTE OF MANAGEMENT AND TECHNOLOGY FOR WOMEN

(Sponsored by Law Educational Society)

(Aided by JNTU(H) Hyderabad & Approved by AICTE, New Delhi)



Date: 10-12-2019

To,  
**Manisha Saboo**  
Head of **Infosys SEZ Campus**  
Survey No. 41 (Pt),50 (pt), Pocharam Village,  
Singapore Township PO, Ghatkesar Mandal,  
Malkajgiri, Hyderabad, 500088

Sub: Request permission for our B. TECH Students to visit your Organization-Reg.

Dear Sir,

We are one of the 8 well-reputed engineering institutions under Vignans Group of Institution, situated in Kondapur, Ghatkesar about 15kms from the city of Hyderabad. We are always ranked within first 10 ranks in JNTUH (Hyderabad). We would like our student to get exposed to the industrial environment and more importantly industry practices, which would help them, upon their entry into any industry, to get in industry environment faster and deliver their jobs efficiently.

We are very much interested to bring our students to your esteemed Organization for an industrial visit. Two of our faculty will accompany the students for maintaining discipline and order during the visit. We assure you that we would not disturb your regular work/production and conduct our student with utmost discipline.

I request you to kindly grant permission for 100 students visiting on two Sessions in one day.

Thanking you,

Yours sincerely,

*[Signature]*  
**HOD-CSE**

Department of Computer Science and Engineering  
Vignans Institute of Management & Technology For Women  
Kondapur (V), Ghatkesar (M), Malkajgiri (D)-501301



*[Signature]*  
**PRINCIPAL**

Vignans Institute of Management & Technology For Women  
Kondapur(V), Ghatkesar(M), Malkajgiri(D)-501301  
Telangana State





# VIGNAN'S INSTITUTE OF MANAGEMENT AND TECHNOLOGY FOR WOMEN

(Sponsored by Lavu Educational Society)

[Affiliated to JNTUH, Hyderabad & Approved by AICTE, New Delhi]

Kondapur (V), Ghatkesar (M), Medchal-Malkajgiri (D) - 501 301. Phone: 96529 10002/3

Department of Computer Science and Engineering

Date: 06/12/2019

Sub :- Request seeking permission to Industrial Visit - reg

It is proposed to Industrial Visit- 21-12-2019 for the III B.Tech CSE students. The details of schedule and budget are mentioned in Table 1 & Table 2 respectively.

A total of 115 students are participating in this seminar as it is useful for the students in the current semester.

S. No.	Days	Schedule	Faculty Members	Designation
	1	21-12-2019	Mrs. Deepthi Sri Mr. P. Vinay Bhushan	Asst. Professor, VMTW

Table 1: Details of schedule

S. No.	Expenditure	
1	Buses	4000
2	Food Expenditure	10000
3	Drivers allowances	2000
4	Others	2000
5	Total Expenditure	18000

Table 2: Details of Expenditure

We request you to give permission for conducting this Industrial Visit and sanction the Amount of R 18000/.

Submitted for Approval  
HOD CSE



*P. Sudhakar*  
PRINCIPAL  
Vignan's Institute of Management & Technology For Women  
Kondapur (V), Ghatkesar (M), Medchal-Malkajgiri (D) - 501301  
Telangana State

*[Signature]*  
PRINCIPAL  
Vignan's Institute of Management & Technology For Women  
Kondapur(V), Ghatkesar(M), Medchal-Malkajgiri(D)-501301  
Telangana State



# VIGNAN'S INSTITUTE OF MANAGEMENT AND TECHNOLOGY FOR WOMEN

(Sponsored by Lavu Educational Society)

[Affiliated to JNTUH, Hyderabad & Approved by AICTE, New Delhi]

Kondapur (V), Ghatkesar (M), Medchal-Malkajgiri (D) - 501 301. Phone: 96529 10002/3

Department of Computer Science and Engineering

VMTW/CSE/2020/SEM-II/Cir-01

Date: 18.12.2019

## CIRCULAR

This is to inform all the HOD's, staff and students that there will be an Industrial Visit for all CSE students on **21-12-2019** at INFOSYS. The Industrial Visit co-ordinate by Mrs. D. Deepthi Sri, Asst.Prof, Mr. P.Vinay Bhushan, Asst. Prof and. All the students are hereby informed to assemble in college campus by 8.00 am and to attend the INFOSYS and make it a successful one.

Head of Department  
Computer Science and Engineering  
Vignan's Institute of Management & Technology For Women  
Kondapur (V), Ghatkesar (M), Medchal-Malkajgiri (D), 501301



PRINCIPAL  
Vignan's Institute of Management & Technology For Women  
Kondapur(V), Ghatkesar(M), Medchal-Malkajgiri(D)-501301  
Telangana State



# VIGNAN'S INSTITUTE OF MANAGEMENT AND TECHNOLOGY FOR WOMEN

(Sponsored by Lavu Educational Society)

[Affiliated to JNTUH, Hyderabad & Approved by AICTE, New Delhi]

Kondapur (V), Ghatkesar (M), Medchal-Malkajgiri (D) - 501 301. Phone: 96529 10002/3

Department of Computer Science and Engineering

Date: 21.01.2020

## NOTE

Sub: Report of "Industrial Visit" on on 21.12.2019 -Reg.

A One day Industrial Visit has been coordinate by **Mr.P.Vinay Bhushan, Asst.Prof , Mrs. D. Deepthi Sri, Asst. Prof** and, at INFOSYS, in order to increase the awareness among the students.

The Industrial Visit was an informative and interesting. All the students of CSE had knowledge in Software to convey a reliably sure client experience Encourage the Cultures that are worlds apart, unique in their ways yet universal in their outlook. Strategies for leading enterprises that are changing the way the world goes around. Research projects that are on the leading edge of digital innovation.

Infosys Instep attracts minds across disciplines like management, technology and liberal arts, with projects ranging from machine learning to the human facets of leadership.

After attending this Industrial Visit –Students have expressed about their capability in usage of empower organizations to deliver secure, tap-based interactions with an intuitive, reliable experience. On behalf of the students I request you to arrange more Industrial Visit for students to improve the knowledge of students and enhance the career opportunities.

Mr. P. Vinay Bhushan

Asst. Professor (CSE)



PRINCIPAL

Vignan's Institute of Management & Technology For Women  
Kondapur(V),Ghatkesar(M),Medchal-Malkajgiri(D)-501301  
Telangana State



# VIGNAN'S INSTITUTE OF MANAGEMENT AND TECHNOLOGY FOR WOMEN

Sponsored by Lawu Educational Society, Approved by AKTE, New Delhi & Affiliated to JNTUH, Hyderabad.  
Kondapur (V), Ghatkesar (M), Medchal - Malkajgiri (D) - 501 301 Phone: +91 96529 10002/3



*VASH*

PRINCIPAL

Vignan's Institute of Management & Technology For Women  
Kondapur (V), Ghatkesar (M), Medchal - Malkajgiri (D) - 501301  
Telangana State



# VIGNAN'S INSTITUTE OF MANAGEMENT AND TECHNOLOGY FOR WOMEN

(Sponsored by Lavu Educational Society)  
[Affiliated to JNTUH, Hyderabad & Approved by AICTE, New Delhi]  
Kondapur (V), Ghatkesar (M), Medchal - Malkajgiri (D) - 501 301. Phone: 96529 10002/3



## Department of Computer Science and Engineering

### LIST OF STUDENTS CSE-A

14UP1A0505	B.MEGHANA
15UP1A0501	ANNAVARAPU HIMA
15UP1A0502	RAJYALAKSHMI
15UP1A0503	BASUDE PREETHI
15UP1A0504	BAYYADUGULA PRAVEENA
15UP1A0505	BEENAMOHINA TEJASVEE YADAV
15UP1A0506	BODIKA SANDHYA RANI
15UP1A0507	BOLLOJU RAMYA SMRUTHI
15UP1A0508	BOMMA AKHILA
15UP1A0509	BONTHU TARUNA SRI
15UP1A0510	BURUGU TEJASRI
15UP1A0511	CHENNALA GAYATRI YADAV
15UP1A0512	CHINDAM PRANAVA
15UP1A0513	CHOWDARAPU SRIJA
15UP1A0514	D A DIVYA
15UP1A0515	D ANUSHA
15UP1A0516	DAMULURI DIVYA
15UP1A0517	DENDUKURU SRIREKHA
15UP1A0518	DHARNI MANISHA
15UP1A0519	G VAISHNAVI
15UP1A0520	GOLEM SUPRAJA CHINMAYEE
15UP1A0521	GULLIPALLI JAHNAVI
15UP1A0522	GUNDA SOWMYA
15UP1A0523	GURDEEP KAUR JANDU
15UP1A0524	K ANUSHA
15UP1A0525	K SHRUTHI
15UP1A0526	KAMBALAPALLY MOUNIKA
15UP1A0527	KOTIKA SIVA PARVATHI
15UP1A0528	KRISHNADHARI SOWJANYA
15UP1A0529	MANJULA DIGAMBER DEVKATTE
15UP1A0530	MARPU SWETHA REDDY
15UP1A0531	MOGULURU VENKATA
15UP1A0532	NAGASWETHA
15UP1A0533	N NIHARIKA REDDY
15UP1A0534	NAKREKANTI PRASHANTHI
15UP1A0535	NERELLA TEJASWINI
15UP1A0536	PADMAM KRISHNAVENI
15UP1A0537	PANAGANTI MADHUSHALINI
15UP1A0538	POTHAM JYOSHNA DEVI



  
PRINCIPAL  
Vignans Institute of Management & Technology For Women  
Kondapur(V), Ghatkesar(M), Medchal-Malkajgiri(D) - 501301  
Telangana State



**VIGNAN'S INSTITUTE OF MANAGEMENT  
AND TECHNOLOGY FOR WOMEN**

(Sponsored by Lawu Educational Society)  
[Affiliated to JNTUH, Hyderabad & Approved by AICTE, New Delhi]  
Kondapur (V), Ghatkesar (M), Medchal - Malkajgiri (D) - 501 301. Phone: 96529 10002/3



**Department of Computer Science and Engineering**

15UPIA0541	PULAMONI PRAVALIKA
15UPIA0542	PULGAM KAVYA
15UPIA0544	SARIKONDA POOJA
15UPIA0545	SRAVANI REDDY BARLAPALLY
15UPIA0546	SRI RAMA VINEETHA
15UPIA0547	SUNKARA SAIMOUNIKA
15UPIA0549	SWARGAM MOUNIKA
15UPIA0550	THOUTAM CHANDANA
15UPIA0551	VALABOJU DIVYA SRI

**CSE-B**

15UPIA0552	AKULA VANAJA
15UPIA0553	AKUULA PRIYANKKA
15UPIA0554	ANANTHULA RAVALI
15UPIA0555	ANDAM SIRISHA
15UPIA0556	BANDI RASHMITHA
15UPIA0557	BAREDDY SRAVANTHI
15UPIA0559	BOPPIDI ROOPASRI
15UPIA0560	CHANDA VARALAXMI
15UPIA0562	CHIRABOINA RAMADEVI
15UPIA0563	CHOWDAVARAPU LAKSHMI PRIYA
15UPIA0564	DARIPALLI AMANI
15UPIA0565	EDUKULLA LIKITHA
15UPIA0567	GOPISHETTY SAHAJA
15UPIA0568	K NAVA JYOTHI
15UPIA0569	KANDULA MANMITHA
15UPIA0570	KARLA AMULYA
15UPIA0571	L SONALI
15UPIA0572	MANDADI MOUNIKA
15UPIA0573	MARYALA DIKSHITHA
15UPIA0574	MENDE KAVYA
15UPIA0575	MIRYALA SRI LAKSHMI
15UPIA0576	MOOLA VIDYA SRI
15UPIA0577	N USHARANI
15UPIA0578	NANDINI BANDARU
15UPIA0579	NANGUNURI NAVYA SRI
15UPIA0580	PENDYALA LASYA PRIYA
15UPIA0581	PININTI NIHARIKA REDDY
15UPIA0582	PUTTA DEEKSHITHA
15UPIA0583	RAMADEVI SEELAM



*Wadh*

PRINCIPAL

Vignan's Institute of Management & Technology for Women  
Kondapur (V), Ghatkesar (M), Medchal - Malkajgiri (D) - 501 301  
Telangana State



**VIGNAN'S INSTITUTE OF MANAGEMENT  
AND TECHNOLOGY FOR WOMEN**

(Sponsored by Lawu Educational Society)  
[Affiliated to JNTUH, Hyderabad & Approved by AICTE, New Delhi]  
Kondapur (V), Ghatkesar (M), Medchal - Malkajgiri (D) - 501 301. Phone: 96529 10002/3



**Department of Computer Science and Engineering**

15UPIA0584	RAVALKOLE MANASA
15UPIA0585	RAVIRALA HARSHITHA
15UPIA0586	RELANGI VIJAYA DURGA
15UPIA0587	SAGIREDDY HEVANYA
15UPIA0588	SAMALA ANUSHA
15UPIA0589	SANTHAPURI VAISHNAVI
15UPIA0590	SOMA SHRUTHI
15UPIA0591	SUMREDDY ABHINAYA
15UPIA0592	SUNKARI SOWMYA REDDY
15UPIA0593	TALAPAREDDY SANGHAVI
15UPIA0594	THIRMANI BHAVANI
15UPIA0595	VEERANALA MANASA
15UPIA0596	VELAPATI SOWMYA
15UPIA0598	VEMI REDDY LAKSHMI KALYANI
15UPIA0599	VODDE DIVYA
15UPIA05A1	VOOTUKURY PRAVALLIKA
15UPIA05A2	VORUGANTI PRAVALLIKA
15UPIA05A3	MAHVEEN ARSHI



*2/2/21*  
PRINCIPAL  
Vignan's Institute of Management & Technology for Women  
Kondapur(V), Ghatkesar(M), Medchal-Malkajgiri(D)-501301  
Telangana State

Vignan's Institute of Management and Technology for Women  
Kondapur(V), Ghatkesar (M), Medchal(dt)

**Industrial Visit Feedback**

Name of Student R. MANASA  
Semester III-D Group CSE Date of Visit 21-12-19  
Name & Address of Company Visited PROFOSYS

Tick the most appropriate option without any bias:

	Strongly Disagree			Strongly Agree	
1. The visit was technology oriented	1	2	3	✓	5
2. The program was applicable to my future needs	1	2	3	✓	5
3. Enhancement in skills	1	2	3	✓	5
4. The program was well placed within the allotted time	1	2	3	4	✓
5. The Resource/Industry person was a good communicator	1	2	3	4	✓
6. The material was presented in an organized manner	1	2	3	4	✓
7. I would be interested in attending such visits in future	1	2	3	4	✓
8. Any suggestions for improvement?					

\_\_\_\_\_

\_\_\_\_\_

Please return this form to the coordinator.

*Manasa*  
Signature of student



*[Signature]*  
PRINCIPAL  
Vignan's Institute of Management & Technology For Women  
Kondapur(V), Ghatkesar(M), Medchal-Medchal(Dt)-501301  
Telangana State



Vignan's Institute of Management and Technology for Women  
Kondapur(V), Ghatkesar (M), Medchal(dt)

**Industrial Visit Feedback**

Name of Student D. Sonali  
Semester III-II Group C&E Date of Visit 21-12-2019  
Name & Address of Company Visited Inforsys

Tick the most appropriate option without any bias:

	Strongly Disagree			Strongly Agree	
1. The visit was technology oriented	1	2	3	4	5
2. The program was applicable to my future needs	1	2	3	4	5
3. Enhancement in skills	1	2	3	4	5
4. The program was well placed within the allotted time	1	2	3	4	5
5. The Resource/Industry person was a good communicator	1	2	3	4	5
6. The material was presented in an organized manner	1	2	3	4	5
7. I would be interested in attending such visits in future	1	2	3	4	5
8. Any suggestions for improvement?					

Please return this form to the coordinator.

Sonali  
Signature of student



[Signature]  
PRINCIPAL  
Vignan's Institute of Management & Technology For Women  
Kondapur(V), Ghatkesar(M), Medchal-Malkajiri(Dt)-501301  
Telangana State



# VIGNAN'S INSTITUTE OF MANAGEMENT AND TECHNOLOGY FOR WOMEN

Sponsored by Lavu Educational Society, Approved by AICTE, New Delhi & Affiliated to JNTUH, Hyderabad.  
Kondapur (V), Ghatkesar (M), Medchal - Malkajgiri (D) - 501 301 Phone: +91 96529 10002/3



VMTW/CSE/CIR/2019-20/11/04

Date: 18/01/2020

## CIRCULAR

This is to inform all the faculties and students that there is a Three-Days Workshop on “**Image Processing**” scheduled on 21-01-2020 to 23-01-2020 .In this regard students are instructed to attend the workshop without fail

**PRINCIPAL**

PRINCIPAL  
Vignani's Institute of Management & Technology For Women  
Kondapur (V), Ghatkesar (M), Medchal-Malkajgiri (Dt)-501301  
Telangana State

Copy to:

1. CEO for information,
2. IQAC,
3. Admin Office,
4. HODs (CSE, IT, ECE, EEE, BSH),
5. All Notice Boards
6. Circulate to all Class Rooms,
7. File.



*[Signature]*  
PRINCIPAL  
Vignani's Institute of Management & Technology For Women  
Kondapur (V), Ghatkesar (M), Medchal-Malkajgiri (Dt)-501301  
Telangana State



# VIGNAN'S INSTITUTE OF MANAGEMENT AND TECHNOLOGY FOR WOMEN

(Sponsored by Lavu Educational Society)

Approved by AICTE, New Delhi & Affiliated to JNTUH, Hyderabad.

Kondapur (V), Ghatkesar (M), Medchal - Malkajgiri (D) - 501 301



## DEPARTMENT OF COMPUTER SCIENCE AND ENGINEERING

ORGANIZING

# A WORKSHOP ON IMAGE PROCESSING

21<sup>ST</sup> - 23<sup>RD</sup> JANUARY, 2020 @ SEMINAR HALL



Resource Person:

**Dr. P. Srinivasa Rao,**

Professor,  
JBIET, Hyderabad.

In association with:



Accredited by NAAC & NBA, Approved by AICTE  
& Permanently Affiliated to JNTUH

**Chief Patron:**

**Dr. Lavu Rathalah,**  
Chairman, Vignan Group.

**Patron:**

**Mr. B. Shrovan,**  
CEO, Vignan Group.

**Co-Patron:**

**Dr. K. Chandra Shekar,**  
Principal, VMTW.

**Advisor:**

**Mrs. V. Indrani,**  
Associate Professor & HOD  
Dept. of CSE.

**Co-Ordinator:**

**Mrs. D. Deepthi,**  
Assistant Professor, CSE  
Cell: +91 96529 10002



technology  
digital  
computer  
internet  
image processing

PRINCIPAL  
Vignan's Institute of Management & Technology For  
Kondapur (V), Ghatkesar (M), Medchal-Malkajgiri  
Telangana State



# VIGNAN'S INSTITUTE OF MANAGEMENT AND TECHNOLOGY FOR WOMEN

Sponsored by Lawu Educational Society, Approved by AICTE, New Delhi & Affiliated to JNTUH, Hyderabad.  
Kondapur (V), Ghatkesar (M), Medchal - Malkajgiri (D) - 501 301 Phone: +91 96529 10002/3



## DEPARTMENT OF COMPUTER SCIENCE AND ENGINEERING

Date: 27-01-2020

### Report on IMAGE PROCESSING

**Type of Program:** Workshop

**Date:** 21-01-2020 to 23-01-2020

**No. of Students Participated:** 60

**Faculty Coordinator:** Mrs. D. Deepthi

**Resource Person:** Dr. P. Srinivasa Rao, Professor, Department of CSE,  
J.B. Institute of Engineering & Technology



**Objective:** The workshop on Image Processing was conducted from 21-01-2020 to 23-01-2020 at VMTW. The primary objective of the workshop was to familiarize students with the fundamental concepts, techniques, and applications of image processing. The workshop began with an introduction to image processing, emphasizing its importance in various fields such as computer vision, medical imaging, and multimedia. The instructors highlighted the basic concepts of digital images, image representation, and the different stages of the image processing pipeline.



*[Signature]*  
PRINCIPAL  
Vignans Institute of Management & Technology For Women  
Kondapur (V), Ghatkesar (M), Medchal-Malkajgiri (D)-501301  
Telangana State



# VIGNAN'S INSTITUTE OF MANAGEMENT AND TECHNOLOGY FOR WOMEN

Sponsored by Lawu Educational Society, Approved by AICTE, New Delhi & Affiliated to JNTUH, Hyderabad.  
Kondapur (V), Ghatkesar (M), Medchal - Malkajgiri (D) - 501 301 Phone: +91 96529 10002/3



**Outcomes:** The workshop on Image Processing provided students with a comprehensive understanding of image processing techniques, their applications, and practical implementation. Participants gained hands-on experience through practical exercises and projects, enhancing their ability to analyze, enhance, restore, and segment images. The workshop successfully equipped participants with valuable skills in the field of image processing.

The workshop on Image Processing proved to be an enriching experience for students, enabling them to apply image processing techniques effectively in various domains and fostering their interest in further exploration of the field.

*Deepthi*  
**COORDINATOR**

*V. Indira*  
**H.O.D**

Head of The Department  
Computer Science and Engineering  
Vignan's Institute of Management & Technology For Women  
Kondapur (V), Ghatkesar (M), Medchal-Malkajgiri (Dt)-501301  
Telangana State



*Vignan*  
**PRINCIPAL**  
Vignan's Institute of Management & Technology For Women  
Kondapur (V), Ghatkesar (M), Medchal-Malkajgiri (Dt)-501301  
Telangana State

### Workshop on Image Processing

Course Instructor : Dr. P. Srinivasa Rao

S.No	Roll No	Student Name	21-Jan	22-Jan	23-Jan
1	19UP1A0559	BethiKeerthana	Keerthana	Ab	Keerthana
2	19UP1A0560	Cheekati.Kushitha	Kushitha	Kushitha	Kushitha
3	19UP1A0561	CherukuMinisha	Ab	Minisha	Ab
4	19UP1A0562	DevanooriUshasri	Ushasri	Ushasri	Ushasri
5	19UP1A0563	DiddiVasavi	Vasavi	Vasavi	Vasavi
6	19UP1A0564	DondaJinganiya	Ab	Vasavi	Vasavi
7	19UP1A0565	DonthaAkshaya	Akshaya	Ab	Akshaya
8	19UP1A0566	Gajjala.Anusha	Anusha	Anusha	Anusha
9	19UP1A0567	Ganga Velakya	Velakya	Velakya	Velakya
10	19UP1A0568	J.Meghana	Meghana	Meghana	Meghana
11	19UP1A0569	KandiSriharshini	Sri	Ab	Sri
12	19UP1A0570	KarlapatiSreenija	Sreenija	Sreenija	Sreenija
13	19UP1A0571	Kommhneni Pooja Sri	Pooja	Pooja	Pooja
14	19UP1A0572	K.Akshitha Reddy	Akshitha	Akshitha	Ab
15	19UP1A0573	MaddiSreeja	Sreeja	Sreeja	Sreeja
16	19UP1A0574	ManthanaGouri	Gouri	Gouri	Gouri
17	19UP1A0575	MedaKeerthana	Keerthana	Keerthana	Keerthana
18	19UP1A0576	MettuSankirithana	Ab	Sankiritha	Sankiritha
19	19UP1A0577	MirapakayalaDivya	Divya	Divya	Divya
20	19UP1A0578	Mohammad Afshin	Afshin	Afshin	Ab
21	19UP1A0579	M LaxmiPrasanna	Ab	Prasanna	Prasanna
22	19UP1A0580	MyakalaPranayateja	Pranayateja	Pranayateja	Pranayateja
23	19UP1A0581	Nadia Niloufer	Ab	Niloufer	Niloufer
24	19UP1A0582	NagangarRashika	Rashika	Ab	Rashika
25	19UP1A0583	NagillaSravani	Sravani	Sravani	Sravani
26	19UP1A0584	NamgariShirisha	Shirisha	Shirisha	Shirisha
27	19UP1A0585	NuthetiRohini	Rohini	Rohini	Ab
28	19UP1A0586	PagidiPradeedthi	Pradeedthi	Pradeedthi	Pradeedthi
29	19UP1A0587	PancherupulaShivani	Shivani	Shivani	Shivani
30	19UP1A0588	PendemRechitha	Rechitha-P	Rechitha-P	Rechitha-P
31	19UP1A0589	PoonumalliHarshitha	Harshitha	Ab	Harshitha
32	19UP1A0590	KallemRuthika Reddy	Ruthika	Ruthika	Ab
33	19UP1A0591	ShivareddyDeepti	Deepti	Deepti	Deepti
34	19UP1A0592	Shaik Saba Sultana	Sultana	Ab	Sultana
35	19UP1A0593	Saini Sai Priya	Saipriya	Saipriya	Saipriya
36	19UP1A0594	SeelamsettyRoshini	Ab	Roshini	Roshini
37	19UP1A0595	Suhana	Suhana	Suhana	Suhana



PRINCIPAL  
Vignani's Institute of Management & Technology For Women  
Kondapur (V), Ghatkesar (M), Medchal-Malkajgiri (CY) 501301  
Telangana State

38	19UP1A0596	Syed Ayesha	ayesha	ayesha	ayesha
39	19UP1A0597	ThopuBhavya	bhavya	bhavya	bhavya
40	19UP1A0598	VadlamudiSamyuktha	Samyuktha	Ab	Samyuktha
41	19UP1A0599	VakitiHrithika	Ab	Ab	Ab
42	19UP1A05A0	VempatiKavya	Kavya	Kavya	Kavya
43	19UP1A05A1	Yallampally Neha	Neha	Neha	Neha
44	19UP1A05A2	YenughantiNikhitha	Ab	Nikhitha	Nikhitha
45	19UP1A05A3	AvanalaDeekshitha	deekshitha	deekshitha	deekshitha
46	19UP1A05A4	BaduguCharani	Charani	Charani	Charani
47	19UP1A05A5	Banda Swetha	Swetha	Ab	Swetha
48	19UP1A05A6	BodlaSravani	Sravani	Sravani	Sravani
49	19UP1A05A7	Boga Vaisnavi	Vaisnavi	Vaisnavi	Vaisnavi
50	19UP1A05A8	ByreddyYashaswi	Yashaswi	Yashaswi	Yashaswi
51	19UP1A05A9	Shinde Chandrika	Chandrika	A	Chandrika
52	19UP1A05B0	ChithakuntalaPoojitha	Poojitha	Poojitha	Poojitha
53	19UP1A05B1	Dasaraju Sandhya	Sandhya	Sandhya	Sandhya
54	19UP1A05B2	DendeAakansha	A	Aakansha	A
55	19UP1A05B3	Dhanthuri Sai Aishwarya	Aishwarya	Aishwarya	Aishwarya
56	19UP1A05B4	Enreddy Sai Chaithra	Chaithra	A	Chaithra
57	19UP1A05B5	GyaraChandhana	Chandhana	Chandhana	Chandhana
58	19UP1A05B6	GaddamAkshitha	Akshitha	Akshitha	Akshitha
59	19UP1A05B7	GantelaSupriya	Supriya	Supriya	Supriya
60	19UP1A05B8	GoginentiMugdaShishira	A	Mugda	A

Deepthi  
COORDINATOR

V. Indira  
HOD-CSE

Head of The Department  
Computer Science and Engineering  
Vignan's Institute of Management & Technology For Women  
Kondapur (V), Ghatkesar (M), Medchal-Malkajgiri (Dt)-501301  
Telangana State



PRINCIPAL  
Vignan's Institute of Management & Technology For Women  
Kondapur (V), Ghatkesar (M), Medchal-Malkajgiri (Dt)-501301  
Telangana State



# VIGNAN'S INSTITUTE OF MANAGEMENT AND TECHNOLOGY FOR WOMEN

(Sponsored by Lavu Educational Society)

Approved by AICTE, New Delhi & Affiliated to JNTUH, Hyderabad.

Kondapur (V), Ghatkesar (M), Medchal - Malkajgiri (D) - 501 301

Accredited By



In association with:



## CERTIFICATE OF PARTICIPATION

This certificate is presented to Ms. *B. Charani*.....  
for her participation in a workshop on "Image Processing" held from  
21st - 23rd January, 2020, Organized by the Department of Computer  
Science and Engineering, in association with JB Institute of Engineering &  
Technology, Hyderabad.

*Deepthi*  
**Co-Ordinator**



*V. Jindani*  
**HoD, CSE**

*[Signature]*  
PRINCIPAL  
Vignans Institute of Management & Technology For  
Kondapur (V), Ghatkesar (M), Medchal-Malkajgiri (D)-501301  
Telangana State

*[Signature]*  
**Principal**





# VIGNAN'S INSTITUTE OF MANAGEMENT AND TECHNOLOGY FOR WOMEN

[Sponsored by Lavu Educational Society]

(Approved by AICTE, New Delhi & Affiliated to JNTUH, Hyderabad.)

Kondapur (V), Ghatkesar (M), Medchal - Malkajgiri (D) - 501 301 Phone: +91 96629 10002/3



VMTW/TP/CIR/2019-20/13

Date: 18-01-2020

## CIRCULAR

All the HODs and Placement Coordinators are hereby requested to inform 3<sup>rd</sup> B.Tech students that "Campus Recruitment Training by IPSC" will be conducted in our college starting from 20-01-2020 to 29-01-2020. Contact T&P Cell for further information

Copy to ...

1. CEO for information,
2. IQAC,
3. Admin Office,
4. HODs (CSE, IT, ECE, EEE, BSH),
5. Notice Board,
6. Circulate to all Class Rooms,
7. File.

PRINCIPAL  
Vignans Institute of Management & Technology For Women  
Kondapur (V), Ghatkesar (M), Medchal-Malkajgiri (Dt.)-501301  
Telangana State



  
PRINCIPAL  
Vignans Institute of Management & Technology For Women  
Kondapur (V), Ghatkesar (M), Medchal-Malkajgiri (Dt.)-501301  
Telangana State



Training & Placement Cell

Report on CRT Program Conducted by IPSC

**Name of the Programme:** Campus Recruitment Training

**Syllabus:** Introduction to Python, installation of python, ways of execution of the python, Basic of python and daily task, Python Modules, Python Pandas, Multi Threading, Exception Handling, python GUI

**Objective:** To train the students in areas such as verbal aptitude, reading comprehension, fundamentals of programming and soft skills to make them ready for placements.

**Name of the Organization:** IPSC

**Course Instructor:** K. Venkata Sandeep

**Dates of the program:** 20-01-2020 to 29-01-2020

**Number of students attended:** 77



**Outcome:** Students were trained in fundamentals of programming, verbal aptitude, reading comprehension, soft skills, group discussions, interview skills. Resume writing, and email and telephone etiquette, making them ready for campus placements.

The undersigned thanked the respective department coordinators and IPSC, for their able support in completing the program successfully.

**Date:** 27-01-2020

**Training & Placement Officer**

Training & Placement Officer  
Vignan's Institute of Management  
and Technology for Women  
Kondapur (V), Ghatkesar (M),  
Medchal-Malkajgiri Dist-501301



*[Handwritten signature]*

**PRINCIPAL**

Vignan's Institute of Management & Technology for Women  
Kondapur(V),Ghatkesar(M),Medchal-Malkajgiri(D)-501301  
Telangana State



# VIGNAN'S INSTITUTE OF MANAGEMENT AND TECHNOLOGY FOR WOMEN

[Sponsored by Lavu Educational Society]

(Approved by AICTE, New Delhi & Affiliated to JNTUH, Hyderabad.)

Kondapur (V), Ghatkesar (M), Medchal - Malkajgiri (D) - 501 301 Phone: +91 96529 10002/3



## "Campus Recruitment Training by IPSC"

### Attendance Sheet

Date: 20-01-2020 to 29-01-2020

SN	Roll No	Name	20/01	21/01	22/01	23/01	24/01	25/01	28/01	29/01
1	16UP1A0580	Y Vishitha	P	AB	P	P	P	P	P	P
2	176C1A0581	P Rama Lakshmi	P	P	P	P	AB	P	P	P
3	176C1A0582	R V Lahari	P	P	P	P	P	P	P	P
4	17UP1A0501	A Sreshta	P	P	AB	P	P	P	P	P
5	17UP1A0502	Annem Hari Priya	P	P	P	P	P	P	P	P
6	17UP1A0503	Ashala Harika	P	P	P	P	P	P	P	P
7	17UP1A0504	Bandla Saujanya	AB	P	P	P	P	P	P	P
8	17UP1A0505	B. Renuka Chowdary	P	P	P	P	P	P	P	P
9	17UP1A0506	Bourishetty Harika	P	P	P	P	P	P	P	P
10	17UP1A0507	Bulchkur Ramesh Sankirtana	AB	P	P	P	P	P	P	P
11	17UP1A0508	Cheepu Vineesha	P	P	P	AB	P	P	P	P
12	17UP1A0509	Dasari Divya	P	P	P	P	P	P	P	P
13	17UP1A0510	Dubba Mounikareddy	P	P	P	P	AB	P	P	P
14	17UP1A0511	Gangula Megana	P	P	P	P	P	AB	P	P
15	17UP1A0512	Godishala Vishalini	P	P	P	P	P	P	P	P
16	17UP1A0513	Gundrathi Siri Chandana	P	AB	P	P	P	P	P	P
17	17UP1A0514	Jakkam Jyothsna	P	P	P	P	P	P	AB	P
18	17UP1A0515	Jilla Shivani	P	P	P	P	P	P	P	P
19	17UP1A0516	Juluru Vyshnavi	P	P	P	P	P	P	P	P
20	17UP1A0517	K Ishwarya	P	P	AB	P	P	P	P	P
21	17UP1A0518	K Yasaswini	P	P	P	P	P	P	P	P
22	17UP1A0519	Kancharla Sarayu	P	P	P	P	P	P	P	P
23	17UP1A0520	Kanuganti Megala	AB	P	P	P	P	P	P	P
24	17UP1A0521	Kasanagottu Yashaswini	P	P	P	P	P	P	P	P
25	17UP1A0522	Kongara Kavya Sri	P	P	P	P	P	P	P	AB
26	17UP1A0523	Konyala Sravani	P	AB	P	P	P	P	P	P
27	17UP1A0524	Kosuri Praneetha	P	P	P	P	P	P	P	P
28	17UP1A0525	Kuthru Vishnava	P	P	P	P	P	P	P	P
29	17UP1A0526	Maduri Vaishnavi	P	P	P	P	P	P	P	P
30	17UP1A0527	Mudiraj Ramya	P	P	AB	P	P	P	P	P
31	17UP1A0528	Nallaboina Muniswathi	P	P	P	P	P	P	P	P
32	17UP1A0529	Nandagiri Shruthi	P	P	P	P	P	P	P	P
33	17UP1A0530	Nayini Priyanka	P	P	P	P	P	P	P	P
34	17UP1A0531	Nidanampally Spoorthy	P	P	P	P	P	P	P	P
35	17UP1A0532	Nune Bhargavi	P	P	P	P	P	P	P	P
36	17UP1A0533	Padala Sri S...	P	P	P	P	P	P	P	P



*[Handwritten Signature]*

PRINCIPAL

Vignan's Institute of Management & Technology for Women  
Kondapur (V), Ghatkesar (M), Medchal-Malkajgiri (D) - 501 301  
Telangana State





# VIGNAN'S INSTITUTE OF MANAGEMENT AND TECHNOLOGY FOR WOMEN

[Sponsored by Lavu Educational Society]

(Approved by AICTE, New Delhi & Affiliated to JNTUH, Hyderabad.)

Kondapur (V), Ghatkesar (M), Medchal - Malkajgiri (D) - 501 301 Phone: +91 96529 10002/3



VMTW/TPC/CIR/2019-20/12

Date: 05-09-2019

## CIRCULAR

All the HODs and Placement Coordinators are hereby requested to inform III- B.Tech students that "Campus Recruitment Training by Fourth Ambit Employability Services" will be conducted in our college starting from 10-09-2019 to 14-09-2019 for all third year CSE students.

Contact T&P Cell for further information.

Copy to:

1. CEO for information,
2. All the Deans,
3. The HOD (CSE / ECE / EEE / IT / AIML/ BSH),
4. IQAC,
5. Admin Office,
6. All Notice Boards,
7. Circulate to all Class Rooms,
8. File.



  
PRINCIPAL

PRINCIPAL  
Vignan's Institute of Management & Technology For Women  
Kondapur (V), Ghatkesar (M), Medchal-Malkajgiri (Dt.)-501301  
Telangana State

  
PRINCIPAL  
Vignan's Institute of Management & Technology For Women  
Kondapur (V), Ghatkesar (M), Medchal-Malkajgiri (Dt.)-501301  
Telangana State



Date: 17-09-2019

**Training placement cell**

**Report on CRT Program Conducted by Fourth Ambit Employability Services**

**Name of the Program:** Campus Recruitment Training

**Syllabus:** Quantitative aptitude, number system, logical reasoning, verbal aptitude. Reading comprehension, computer fundamentals, coding and decoding, group discussion, interview skills, resume writing and email and telephone etiquette.

**Objective:** To train the students in areas such as quantitative aptitude, verbal aptitude, reading comprehension, fundamentals of programming and soft skills to make them ready for placements.

**Name of the Organization:** Fourth Ambit Employability Services

**Course Instructor:** Krish

**Dates of the program:** 10-09-2019 to 14-09-2019

**Number of students attended:** 100



**Outcome:** Students were trained in quantitative aptitude, logical reasoning, verbal aptitude, reading comprehension, soft skills, group discussions, interview skills. Resume writing, and email and telephone etiquette, making them ready for campus placements.

The undersigned thanked the respective department coordinators and FourthAmbit Employability Services, for their able support in completing the program successfully.

Training and Placement Officer

Training & Placement Officer  
Vignan's Institute of Management  
Kondapur (V), Ghatkesar (M),  
Medchal - Malkajgiri (D) - 501 301



**PRINCIPAL**  
Vignan's Institute of Management & Technology For Women  
Kondapur(V), Ghatkesar(M), Medchal-Malkajgiri(D)-501301  
Telangana State

Name of the Organization: Fourth Ambit

Course instructor: Krish

### Training & Placement Cell

#### CRT Program Conducted by Fourth Ambit Employability Services

##### CSE Attendance Sheet

SN	Roll No	Name	10-Sep	11-Sep	12-Sep	13-Sep	14-Sep
1	16UP1A05B0	Y Vishitha	P	P	P	P	P
2	176C1A0581	P Rama Lakshmi	P	P	P	P	P
3	176C1A0582	R V Lahari	P	P	P	P	P
4	17UP1A0501	A Sreshta	P	P	P	P	P
5	17UP1A0502	Annem Hari Priya	P	P	P	P	P
6	17UP1A0503	Ashalaharika	P	P	P	P	P
7	17UP1A0504	BandlaSaujanya	P	P	P	P	P
8	17UP1A0505	BikkasaniRenukaChowdary	P	P	P	P	P
9	17UP1A0506	BourishettyHarika	AB	P	P	AB	P
10	17UP1A0507	Bulchkur Ramesh Sankirtana	P	P	AB	P	P
11	17UP1A0508	CheepuVineesha	P	P	P	P	AB
12	17UP1A0509	DasariDivya	P	AB	P	P	P
13	17UP1A0510	Dubba Mounikareddy	P	P	P	P	P
14	17UP1A0511	GangulaMegana	P	P	P	P	P
15	17UP1A0512	GodishalaVishalini	P	P	P	P	P
16	17UP1A0513	Gundrathi Siri Chandana	P	P	P	P	P
17	17UP1A0514	JakkamJyothsna	P	P	P	P	P
18	17UP1A0515	JillaShivani	P	P	P	P	P
19	17UP1A0516	JuluruVyshnavi	P	P	P	P	P
20	17UP1A0517	K Ishwarya	P	P	P	P	P
21	17UP1A0518	K Yaraswini	P	P	P	P	P
22	17UP1A0519	KancharlaSarayu	P	P	AB	P	P
23	17UP1A0520	KanugantiMegala	P	P	P	P	P
24	17UP1A0521	Kasanagottu Yashaswini	AB	P	P	AB	P
25	17UP1A0522	KongaraKavya Sri	P	P	P	P	P
26	17UP1A0523	KonyalaSravani	P	AB	P	P	P
27	17UP1A0524	KosuriPraneetha	P	P	P	P	AB
28	17UP1A0525	KuthruVishnava	P	P	P	P	P
29	17UP1A0526	MaduriVaishnavi	P	P	P	P	P
30	17UP1A0527	MudirajRamya	P	P	P	P	P
31	17UP1A0528	NallaboinaMuniswathi	P	P	P	P	P



*[Signature]*  
PRINCIPAL  
Vignans Institute of Management & Technology For Women  
Kondapur(V), Ghatkesar(M), Medchal-Malkajgiri(Dt)-501301  
Telangana State

32	17UP1A0529	NandagiriShruthi	P	P	AB	P	P
33	17UP1A0530	Nayini Priyanka	P	P	P	P	AB
34	17UP1A0531	NidanampallySpoorthy	P	P	P	P	P
35	17UP1A0532	NuncBhargavi	P	P	P	P	P
36	17UP1A0533	Padala Sri Satya	P	P	P	P	P
37	17UP1A0534	PallaMadhuri	AB	P	P	AB	P
38	17UP1A0535	PendyamShivaliSagar	P	P	P	P	P
39	17UP1A0536	PesaraChaithanya	P	P	P	P	P
40	17UP1A0537	PolagouniShivani	P	P	P	P	P
41	17UP1A0538	PottumuttuVaishnavi	P	P	P	P	P
42	17UP1A0539	PreetikaKuntala	P	P	P	P	P
43	17UP1A0540	PunnaUmabharathi	P	P	P	P	P
44	17UP1A0541	RasamallaSavitha	P	AB	P	P	P
45	17UP1A0542	SamudralaRajyalaxmi	P	P	P	P	P
46	17UP1A0543	Shruti	P	P	P	P	P
47	17UP1A0544	Sirpur Pooja	P	P	P	P	P
48	17UP1A0545	Soma Shivani	AB	P	AB	P	P
49	17UP1A0546	SurabhiSaipriya	P	P	P	P	P
50	17UP1A0547	SusmaChittanori	P	P	P	P	P
51	17UP1A0548	Thakur Sai Priya	P	P	P	P	AB
52	17UP1A0549	VallapuSwathika	P	P	P	P	P
53	17UP1A0550	YadavalliSowjanya	P	P	P	P	P
54	17UP1A0551	AkulaTejaswini	P	P	P	AB	P
55	17UP1A0552	AnagandulaShashanka	P	P	P	P	P
56	17UP1A0553	AnaganiGnanasri	P	P	P	P	P
57	17UP1A0554	Ankitha Kulkarni	P	P	P	P	P
58	17UP1A0555	AnnaparthyManasa Devi	P	P	P	P	P
59	17UP1A0556	B.Preethi	P	P	P	P	P
60	17UP1A0557	Bandi Sarala	P	AB	P	P	P
61	17UP1A0558	BorruBhargavi	P	P	P	P	P
62	17UP1A0559	Chigurupati Pooja	P	P	P	P	P
63	17UP1A0560	DesidiAkshith	P	P	P	P	P
64	17UP1A0561	DevarajuKiranmayi	P	P	AB	P	P
65	17UP1A0562	E Deepika	P	P	P	P	P
66	17UP1A0563	G J K Keerthana	AB	P	P	P	P
67	17UP1A0564	G Sowmya	P	P	P	P	P
68	17UP1A0565	GadeSwarupa	P	P	P	P	AB
69	17UP1A0566	GarlapatiVedasri	P	AB	P	AB	P
70	17UP1A0567	J V Shivani	P	P	P	P	P
71	17UP1A0568	JaidiShylaja	P	P	P	P	P
72	17UP1A0569	JakuntiSukanya	P	P	P	P	P



  
**PRINCIPAL**  
 Vigyan's Institute of Management & Technology For Women  
 Kondapur(V), Ghatkesar(M), Medchal-Malkajgiri(DR)-501301  
 Telangana State



73	17UP1A0570	Kakkerasindhuj	AB	P	P	P	P
74	17UP1A0571	KalledaDeepika	P	P	AB	P	P
75	17UP1A0572	KompelliVaishnavi	P	P	P	P	P
76	17UP1A0573	Lingala Sharanya	P	P	P	P	P
77	17UP1A0574	M Divya Reddy	P	P	P	P	P
78	17UP1A0575	M Hema	P	P	P	AB	P
79	17UP1A0576	M Navya	P	P	P	P	P
80	17UP1A0577	MalipatelSaikeerthi	P	P	P	P	P
81	17UP1A0578	Marepalli Pooja Reddy	P	P	P	P	P
82	17UP1A0579	MiryalaJyosna	AB	P	P	P	P
83	17UP1A0580	MunikuntlaMokshaja	P	P	P	P	P
84	17UP1A0581	N P AhalyaMangathayaru	P	AB	P	P	P
85	17UP1A0582	Nandhini	P	P	AB	P	P
86	17UP1A0583	P. Maansi Reddy	P	P	P	P	P
87	17UP1A0584	ParuchuriHarika	P	P	P	P	P
88	17UP1A0585	PasupuletiDurgabhavani	P	P	P	P	AB
89	17UP1A0586	PendotaHarshini	P	P	P	AB	P
90	17UP1A0587	Pera Padma Sri	P	P	P	P	P
91	17UP1A0588	PochaboinaPrasanna	P	P	P	P	P
92	17UP1A0589	PoosaTejashwini	P	P	P	P	P
93	17UP1A0590	RamasahayamSreethika	P	P	P	P	P
94	17UP1A0591	TantanapallyMadhuri	AB	P	AB	P	P
95	17UP1A0592	TirumalasettiJahnavi Sai	P	P	P	P	P
96	17UP1A0593	TuthiShirisha	P	P	P	P	P
97	17UP1A0594	VallakatiSreeja	P	AB	P	P	P
98	17UP1A0595	VanteruNischala Reddy	P	P	P	P	P
99	17UP1A0596	Y Ramya Krishna	P	P	P	P	P
100	18UP5A0501	BandariHepsiba	P	P	P	P	P



*Vignee*  
**PRINCIPAL**  
 Vignee's Institute of Management & Technology For Women  
 Kondapur(V), Ghatkesar(M), Medchal-Malkajgiri(Dt)-501301  
 Telangana State



# VIGNAN'S INSTITUTE OF MANAGEMENT AND TECHNOLOGY FOR WOMEN

Sponsored by Lawu Educational Society, Approved by AICTE, New Delhi & Affiliated to JNTUH, Hyderabad.  
Kondapur (V), Ghatkesar (M), Medchal - Malkajgiri (D) - 501 301 Phone: +91 96529 10002/3



VMTW/CSE/CIR/2019-20/II/09

Date: 06/01/2020

## CIRCULAR

This is to inform all the faculties and students that there is a Three-Day Workshop on “**Data Science Toolbox: Essential Tools and Techniques**” scheduled on 08-01-2020 to 10-01-2020. In this regard students are instructed to attend the workshop without fail.

**PRINCIPAL**  
PRINCIPAL

Vignans Institute of Management & Technology For Women  
Kondapur (V), Ghatkesar (M), Medchal-Malkajgiri (Dt)-501301  
Telangana State

Copy to:

1. CEO for information,
2. All the Deans,
3. IQAC,
4. Admin office,
5. HODs (CSE, IT, ECE, EEE, BSH),
6. Notice Board,
7. Circulate to all Class Rooms,
8. File.



*[Handwritten Signature]*  
PRINCIPAL  
Vignans Institute of Management & Technology For Women  
Kondapur (V), Ghatkesar (M), Medchal-Malkajgiri (Dt)-501301  
Telangana State



# VIGNAN'S INSTITUTE OF MANAGEMENT AND TECHNOLOGY FOR WOMEN

(Sponsored by Lawu Educational Society)  
Approved by AICTE, New Delhi & Affiliated to JNTUH, Hyderabad.  
Kondapur (V), Ghatkesar (M), Medchal - Malkajgiri (D) - 501 301



## DEPARTMENT OF COMPUTER SCIENCE & ENGINEERING

# A THREE-DAY WORKSHOP ON DATA SCIENCE TOOLBOX: Essential Tools and Techniques 8<sup>TH</sup> - 10<sup>TH</sup> JAN, 2020 @ SEMINAR HALL



In association with:



Resource Person:  
**Ms. N. Divya**  
HR Manager,  
Surya TechSolutions,  
Techina

Chief Patron:  
**Dr. Leevi Rathalah,**  
Chairman, Vignan Group.

Patron:  
**Mr. B. Shreevan,**  
CEO, Vignan Group.

Co-Patron:  
**Dr. K. Chandra Shekar,**  
Principal, VMTW

Advisor:  
**Mrs. V. Indrani**  
Associate Professor & HOD,  
Dept. of CSE.

Co-Ordinator:  
**Dr. S. Ranga Swamy,**  
Associate Professor, CSE.  
Cell: +91 99898 96548



**PRINCIPAL**  
Vignan's Institute of Management & Technology For Women  
Kondapur(V), Ghatkesar(M), Medchal-Malkajgiri(D)-501301  
Telangana State



# VIGNAN'S INSTITUTE OF MANAGEMENT AND TECHNOLOGY FOR WOMEN

Sponsored by Lavu Educational Society, Approved by AICTE, New Delhi & Affiliated to JNTUH, Hyderabad.  
Kondapur (V), Ghatkesar (M), Medchal - Malkajgiri (D) - 501 301 Phone: +91 96529 10002/3



## DEPARTMENT OF COMPUTER SCIENCE AND ENGINEERING

### Report on “Data Science Toolbox: Essential Tools and Techniques”

**Type of Program:** Workshop

**Date:** 08-01-2020 to 10-01-2020

**No. of Students Participated:** 109

**Faculty Coordinator:** Dr.S.RangaSwamy

**Resource Person:** N.Divya

HR-Manager,SuryatechSolutions-Techona.



**Objective:** Introduction to data science tools, Data exploration and cleaning, Data manipulation and preprocessing, Collaboration and version control.

**Outcomes:** Proficiency in essential data science tools, understanding Machine learning basics, Model evaluation and performance assessment skills, Collaboration and version control proficiency.

A Data Scientist is responsible for extracting, manipulating, pre-processing and generating predictions out of data. In order to do so, he requires various statistical tools and programming languages.

  
COORDINATOR

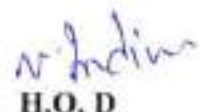
  
H.O. D



  
PRINCIPAL  
Vignani's Institute of Management & Technology For Women  
Kondapur (V), Ghatkesar (M), Medchal-Malkajgiri (D)-501301  
Telangana State

**Workshop on Data Science ToolBox**

**Course Instructor : N.Divya**

S.No	Roll No	Student Name	8-Jan	9-Jan	10-Jan
1	15UP1A0516	DANTULURI ALEKHYA	Alekhy	Alekhy	Alekhy
2	15UP1A0531	MADHUNAGULA SAHITHI	Sahithi	Sahithi	Sahithi
3	15UP1A0543	S AISHWARYA LAKSHMI	Lakshmi	Lakshmi	Lakshmi
4	16UP1A0501	ALUGALA SOWMYA	Sowmya	Sowmya	Sowmya
5	16UP1A0502	AMBATI SHIVANI	Shivani	Shivani	Shivani
6	16UP1A0503	ANAGANI MEENAKSHI	Meenakshi	Meenakshi	Meenakshi
7	16UP1A0504	ANNADANAM SAI PUSHYAMI	Pushyami	Pushyami	Pushyami
8	16UP1A0505	BANDAM SRI VARSHINI	Varshini	Varshini	Varshini
9	16UP1A0506	BEERELI AKANKSHA	Akanksha	Akanksha	Akanksha
10	16UP1A0507	BHUM SANKEERTHANA	Sankeetha	Sankeetha	Sankeetha
11	16UP1A0508	BODA USHASRI	Ushasri	Ushasri	Ushasri
12	16UP1A0509	BODDU NEELIMA YADAV	Neelima	Neelima	Neelima
13	16UP1A0510	BOPPIDI SINDHUMA	Sindhuma	Sindhuma	Sindhuma
14	16UP1A0511	BURRI SAI DEEKSHITHA	Deekshitha	Deekshitha	Deekshitha
15	16UP1A0513	CHALASANI BHAVANI	Bhavani	Bhavani	Bhavani
16	16UP1A0514	DEVASANI HARSHITHA	Harshitha	Harshitha	Harshitha
17	16UP1A0515	ERUGU SARITHA	Saritha	Saritha	Saritha
18	16UP1A0516	GADDIKOPPULA NAGALAKSHMI	Lakshmi	Lakshmi	Lakshmi
19	16UP1A0518	GANGA NIHARIKA	Niharika	Niharika	Niharika
20	16UP1A0519	GANNE SAI BHANU	Bhanu	Bhanu	Bhanu
21	16UP1A0522	JAJULA JHANSI GOUD	Goud	Goud	Goud
22	16UP1A0523	K KEERTHI REDDY	Keerthi	Keerthi	Keerthi
23	16UP1A0524	K S VIDYA	Vidya	Vidya	Vidya
24	16UP1A0525	KAMJULA SRUTHI	Sruthi	Sruthi	Sruthi
25	16UP1A0526	KANDADI SHALINI	Shalini	Shalini	Shalini
26	16UP1A0527	KANDULA PAVITRA	Pavitra	Pavitra	Pavitra
27	16UP1A0528	KASPA CHANDRIKA	Chandrika	Chandrika	Chandrika
28	16UP1A0529	KATHULA BHAVANA	Bhavana	Bhavana	Bhavana
29	16UP1A0530	KATTA SRIANUSHA	Anusha	Anusha	Anusha
30	16UP1A0531	KHANDERAO BRUNDA	Brunda	Brunda	Brunda
31	16UP1A0533	KODAVALI SAI MANIDEEPA	Manideepa	Manideepa	Manideepa
32	16UP1A0534	KOPPOLU SWETHA	Swetha	Swetha	Swetha
33	16UP1A0535	KYATHAM SUJITHA	Sujitha	Sujitha	Sujitha
34	16UP1A0536	MATHANGODU AISWARYA	Aishwarya	Aishwarya	Aishwarya
35	16UP1A0537	MOLLA SHANTI	Shanti	Shanti	Shanti
36	16UP1A0538	NALLAN VINISSRUTA	Vinissruta	Vinissruta	Vinissruta



  
**PRINCIPAL**  
 Nanna's Institute of Management & Technology For Women  
 Kondapur(V), Ghatkesar(M), Medchal-Malkajgiri(D)-501307  
 Telangana State

37	16UP1A0539	NANNURI UDAYASRI	Uday	uday	Uday
38	16UP1A0540	NUKA SAISHMA	Sai	Sai	Sai
39	16UP1A0541	PASALA SINDHU NIHARIKA	Sindhu	Sindhu	Sindhu
40	16UP1A0542	PILLY SUPRIYA	Supriya	Supriya	Supriya
41	16UP1A0543	POLAVENI MEGHASWI	Mouf	Mouf	Mouf
42	16UP1A0544	RAVULA MOUNIKA	Mouf	Mouf	Mouf
43	16UP1A0545	SAGARLA MAHESHWARI	Mahi	Mahi	Mahi
44	16UP1A0546	SAMINENI SREE LAKSHMI	Lakshmi	Lakshmi	Lakshmi
45	16UP1A0547	SRIRAMOJU SWATHI	Swathy	Swathi	Swathi
46	16UP1A0548	SURAKANTI SIRISHA	Sirisha	Sirisha	Sirisha
47	16UP1A0549	THOUTI SAMANA	Sana	Sana	Sana
48	16UP1A0550	UNDADI SRUJANA BHARATHI	Bhara	Bhara	Bhara
49	16UP1A0551	UYYALA TEJASWINI	Teja	Teja	Teja
50	16UP1A0552	VAKITI SAI SINDHU	Sindhu	Sindhu	Sindhu
51	16UP1A0554	VUPPALA SAHITHI	Saithi	Saithi	Saithi
52	16UP1A0555	YALAGALA SAHITHI	Saithi	Saithi	Saithi
53	16UP1A0556	YANNU AKHILA	Akhila	Akhila	Akhila
54	16UP1A0557	A SAI SREE	Sree	Sree	Sree
55	16UP1A0558	A.SAI SRILEKHA	Lekha	Lekha	Lekha
56	16UP1A0559	AKOJU HARIKA	Harika	Harika	Harika
57	16UP1A0560	BALNI RAKSHANA ANGEL	Rakshana	Rakshana	Rakshana
58	16UP1A0561	BANOTH VASAVI	Vasavi	Vasavi	Vasavi
59	16UP1A0562	BICALA SAI LAHARI	Lahari	Lahari	Lahari
60	16UP1A0563	BYREDDY PREETHI	Preethi	Preethi	Preethi
61	16UP1A0564	DAMA PRIYANKA	Priyanka	Priyanka	Priyanka
62	16UP1A0565	DANDOTHKAR MADHURI	Madhuri	Madhuri	Madhuri
63	16UP1A0566	DONDAPATI SANGEETHA	Sangeetha	Sangeetha	Sangeetha
64	16UP1A0567	DOSAKAYALA NIKHITHA DUTT	Nikhitha	Nikhitha	Nikhitha
65	16UP1A0568	G SHIREESHA	Shireesha	Shireesha	Shireesha
66	16UP1A0569	GADDAM PREETHI	Preethi	Preethi	Preethi
67	16UP1A0570	GUNDLAPALLY MANASA	Manasa	Manasa	Manasa
68	16UP1A0571	HINDURAJ	Hinduraj	Hinduraj	Hinduraj
69	16UP1A0572	KAKULARAPU AKHILA	Akhila	Akhila	Akhila
70	16UP1A0573	KATAMONI SAI PRANAVI	Pranavi	Pranavi	Pranavi
71	16UP1A0574	KATTA V SHAIVALINI	Shaivalini	Shaivalini	Shaivalini
72	16UP1A0575	KOLLOJU KEERTHI	Keerthi	Keerthi	Keerthi
73	16UP1A0576	KONDA ANJALI	Anjali	Anjali	Anjali
74	16UP1A0577	KOTAGIRI SAGARIKA	Sagarika	Sagarika	Sagarika
75	16UP1A0578	KOTAPETA MANASA	Manasa	Manasa	Manasa



*[Signature]*  
PRINCIPAL

Vignana's Institute of Management & Technology For Women  
Kondapur(V), Ghatskesar(M), Medchal-Malkajgiri(Dt)-501301  
Telangana State

76	16UP1A0579	KUDIDI SAI CHANDANA	Chandu	chanda	chana
77	16UP1A0580	LAKAPATHRI NITHISHA	Nithya	Nithi	Nithy
78	16UP1A0581	LENKALA SATHVIKA	Sathvika	Sathvi	Sathvika
79	16UP1A0582	MALREDDY DIVYA REDDY	Reddy	Redi	Redy
80	16UP1A0583	MANDAPALLY PHANI PRIYA	Priya	Prhya	Prhya
81	16UP1A0584	MEKALA SHARANYA	Sharanya	Shary	Shary
82	16UP1A0585	MONA MUDIRAJ MEKALA	Mona	Mou	Mou
83	16UP1A0586	MUDDASANI SRAVYA	Sravya	Sray	Sray
84	16UP1A0587	MUKTAPURAM BHAVANI	Bhavani	Bhavi	Bhavi
85	16UP1A0588	NAREDLA RUCHITHA	Ruchita	Ruchi	Ruchit
86	16UP1A0589	NEELI SHRENIKA	Neeli	Ney	Ney
87	16UP1A0590	PALABATLA SHIVANI	Shiva	Shiva	Shiva
88	16UP1A0591	PALLIKONDA SHRAVANI	Shravan	Shran	Shran
89	16UP1A0592	PASHAM SPANDANA	Spandana	Spand	Spand
90	16UP1A0593	PASUPULETI TEJASWINI	Teja	Teja	Teja
91	16UP1A0594	PATLOLLA SRAVANTHI	Sravanti	Sravitha	Sravitha
92	16UP1A0595	PENDEPWAR SAILATHA	Saith	Saith	Saith
93	16UP1A0596	PENUMATCHANAMRATHA	Penam	Penam	Penam
94	16UP1A0597	POTLA MEGHANA	Meghna	Meghna	Meghna
95	16UP1A0598	PRACHI SHARMA	Sharma	Sharma	Sharma
96	16UP1A0599	R.SANTHOSH VANI	Vani	Vani	Vani
97	16UP1A05A0	RAGULA JAMUNA	Jamuna	Jamuna	Jamuna
98	16UP1A05A1	RAMAGIRI USHA RANI	Rani	Rani	Rani
99	16UP1A05A2	SATHILIGARI SRILATHA	Srilatha	Srilath	Srilath
100	16UP1A05A3	SORRA VANDANA	Vandana	Vand	Vand
101	16UP1A05A4	SRIGARLA RUPASRI	Sri	Sri	Sri
102	16UP1A05A5	TANGUTURI KEERTHI REDDY	Keerthi	Keerthi	Keerthi
103	16UP1A05A6	THADURI LAXMI PRASANNA	Prasanna	Prasanna	Prasanna
104	16UP1A05A7	UTNOOR RISHITHA	Rishi	Rishi	Rishi
105	16UP1A05A8	VADDIPATI PRATHYUSHA	Prathyusha	Prathyusha	Prathyusha
106	16UP1A05B1	YEDDULA SRI VIDYA	Vidya	vidya	Vidya
107	166Y1A0564	MANKALA ANUSHA	Anusha	Anusha	Anusha
108	17UP5A0501	PARUPALLY SRAVANTHI	Sravanti	Sran	Sran
109	17UP5A0502	SAMBOJU HIMABINDU	Himabindu	Him	Him



PRINCIPAL

Vignans Institute of Management & Technology For Women  
Kondapur(V), Ghatkesar(M), Medchal-Malajigiri(D)-501301  
Telangana State



# VIGNAN'S INSTITUTE OF MANAGEMENT AND TECHNOLOGY FOR WOMEN

(Sponsored by Lavu Educational Society)

Approved by AICTE, New Delhi & Affiliated to JNTUH, Hyderabad.

Kondapur (V), Ghatkesar (M), Medchal - Malkajgiri (D) - 501 301

Accredited By



In association with:



## Certificate of Participation

*This certificate is presented to Ms. ....A:SHIVANI.....  
for her participation in a three-day workshop on "Data Science Toolbox: Essential Tools and Techniques" held from 08-01-2020 to 10-01-2020, Organized by the Department of Computer Science and Engineering, in association with Techona, Hyderabad.*

*Somy*  
Co-Ordinator



*v. Indira*  
HoD, CSE

*ASH*  
PRINCIPAL  
Vignans Institute of Management & Technology For Women  
Kondapur (V), Ghatkesar (M), Medchal-Malkajgiri (Dt.)-501301  
Telangana State

*ASH*  
Principal





# VIGNAN'S INSTITUTE OF MANAGEMENT AND TECHNOLOGY FOR WOMEN

Sponsored by Lawu Educational Society, Approved by AICTE, New Delhi & Affiliated to JNTUH, Hyderabad.  
Kondapur (V), Ghatkesar (M), Medchal - Malkajgiri (D) - 501 301 Phone: +91 96529 10002/3



VMTW/CSE/CIR/2019-20/1/05

Date: 31/10/2019

## CIRCULAR

This is to inform all the faculties and students that there is a Three-Days Workshop on **"Pattern Recognition"** scheduled on 04-11-2019 to 06-11-2019. In this regard students are instructed to attend the workshop without fail

  
PRINCIPAL

Copy to:

1. CEO for information,
2. IQAC,
3. Admin Office,
4. HODs (CSE, IT, ECE, EEE, BSH),
5. All Notice Boards
6. Circulate to all Class Rooms,
7. File.



  
PRINCIPAL  
Vignani's Institute of Management & Technology For Women  
Kondapur (V), Ghatkesar (M), Medchal-Malkajgiri (D)-501301  
Telangana State



# VIGNAN'S INSTITUTE OF MANAGEMENT AND TECHNOLOGY FOR WOMEN

(Sponsored by Lavu Educational Society)  
Approved by AICTE, New Delhi & Affiliated to JNTU, Hyderabad.  
Kondapur (V), Ghatkesar (M), Medchal - Malkajgiri (D) - 501 301



## DEPARTMENT OF COMPUTER SCIENCE AND ENGINEERING

ORGANIZING

A WORKSHOP ON

# PATTERN RECOGNITION

4<sup>TH</sup> - 6<sup>TH</sup> NOVEMBER, 2019 @ SEMINAR HALL



Resource Person:  
**Mr. Vamshi Krishna S,**  
Associate Professor, CSE,  
Samskruti College of  
Engineering & Technology,  
Hyderabad

In association with:



**SAMSKRUTI**  
COLLEGE OF ENGINEERING & TECHNOLOGY  
Approved by AICTE & Affiliated to JNTU Hyderabad  
Ghatkesar, Medchal Dist, Hyderabad - 501301, T.S.

**Chief Patron:**

**Dr. Lavu Rathaiiah,**  
Chairman, Vignan Group.

**Patron:**

**Mr. B. Shraavan,**  
CEO, Vignan Group.

**Co-Patron:**

**Dr. K. Chandra Shekar,**  
Principal, VMTW.

**Advisor:**

**Mrs. V. Indrani,**  
Associate Professor & HOD,  
Dept. of CSE.

**Co-Ordinator:**

**Mrs. D. Swaroop**  
Assistant Professor  
Cell: +91 96529 0002



## PATTERN RECOGNITION



Vignan's Institute of Management & Technology  
Kondapur (V), Ghatkesar (M), Medchal - Malkajgiri (D)  
Telangana State



# VIGNAN'S INSTITUTE OF MANAGEMENT AND TECHNOLOGY FOR WOMEN

Sponsored by Lavu Educational Society, Approved by AICTE, New Delhi & Affiliated to JNTUH, Hyderabad.  
Kondapur (V), Ghatkesar (M), Medchal - Malkajgiri (D) - 501 301 Phone: +91 96529 10002/3



## DEPARTMENT OF COMPUTER SCIENCE AND ENGINEERING

Date: 09-11-2019

### Report on PATTERN RECOGNITION

**Type of Program:** Workshop

**Date:** 04-10-2019 to 06-10-2019

**No. of Students Participated:** 63

**Faculty Coordinator:** Mrs. D. Swaroopa

**Resource Person:** Mr. S. VamshiKrushna, Associate Professor, Department of CSE,  
Samskruti College of Engineering & Technology.



**Objective:** The workshop on Pattern Recognition was held 04-11-2019 to 06-11-2019 at VMTW. The event aimed to provide students with an in-depth understanding of pattern recognition techniques and their applications across various domains. The workshop commenced with an overview of pattern recognition, emphasizing its significance in computer science, artificial intelligence, and data analysis. The instructors highlighted the fundamental concepts, such as feature extraction, classification algorithms, and evaluation metrics used in pattern recognition systems.



  
PRINCIPAL  
Vignan's Institute of Management & Technology For Women  
Kondapur (V), Ghatkesar (M), Medchal-Malkajgiri (D)-501301  
Telangana State



# VIGNAN'S INSTITUTE OF MANAGEMENT AND TECHNOLOGY FOR WOMEN

Sponsored by Lavu Educational Society, Approved by AICTE, New Delhi & Affiliated to JNTUH, Hyderabad, Kondapur (V), Ghatkesar (M), Medchal - Malkajgiri (D) - 501 301 Phone: +91 98529 10002/3



**Outcomes:** The workshop on Pattern Recognition provided a comprehensive overview of key concepts, techniques, and applications in the field. Participants gained practical skills through hands-on exercises, enabling them to apply pattern recognition algorithms in real-world scenarios. The workshop successfully enhanced the students' knowledge and understanding of pattern recognition, promoting their ability to leverage these techniques in their respective domains.

Overall, the workshop on Pattern Recognition proved to be a valuable learning experience, equipping participants with the necessary knowledge and practical skills to excel in the field of pattern recognition and its application

  
**COORDINATOR**

  
**H.O.D**  
Head of the Department  
Computer Science and Engineering  
Vignans Institute of Management & Technology For Women  
Kondapur (V), Ghatkesar (M), Medchal-Malkajgiri (Dt)-501-301  
Telangana State



  
**PRINCIPAL**  
Vignans Institute of Management & Technology For Women  
Kondapur (V), Ghatkesar (M), Medchal-Malkajgiri (Dt)-501-301  
Telangana State

**Workshop on "Pattern Recognition"**  
**Course Instructor : Mr.Vamshi Krushna S**

S.No	Roll No	Name	4 -NOV	5-NOV	6-NOV
1	16UP1A05A9	VuppalaKeerthi Reddy	Keerthi	Keerthi	Keerthi
2	18UP1A0542	RapoluChandana	Chandana	Chandana	Chandana
3	19UP1A0501	AlladiAshwitha	Ashwitha	Ashwitha	Ashwitha
4	19UP1A0502	AllakattuPranusha	Pranusha	Pranusha	Pranusha
5	19UP1A0503	AmmulaTejaswi	Tejaswi	Tejaswi	A
6	19UP1A0504	BejagamBhavana	Bhavana	Bhavana	Bhavana
7	19UP1A0505	BhoopathiDeepthi	Deepthi	Deepthi	Deepthi
8	19UP1A0506	BoguVyshnavi	Vyshnavi	Vyshnavi	Vyshnavi
9	19UP1A0507	ChamanthulaTejaswini	Tejaswini	Tejaswini	Tejaswini
10	19UP1A0508	ChikatiLikhitha	A	Likhitha	Likhitha
11	19UP1A0509	ChunchuVarshini Yadav	Varshini	Varshini	Varshini
12	19UP1A0510	G.Akankasha	Akankasha	Akankasha	Akankasha
13	19UP1A0511	GaddamAkshitha	Akshitha	Akshitha	Akshitha
14	19UP1A0512	GaddamJoshitha	Joshitha	Joshitha	A
15	19UP1A0513	GardasNikhitha	Nikhitha	Nikhitha	Nikhitha
16	19UP1A0514	GarrePreethi	Preethi	Preethi	Preethi
17	19UP1A0515	GuddetiManognya	A	Manognya	Manognya
18	19UP1A0516	KandulNethra	Nethra	Nethra	Nethra
19	19UP1A0517	KankanalaHarika	Harika	Harika	Harika
20	19UP1A0518	KarnampallyNiharika Reddy	Niharika	Niharika	Niharika
21	19UP1A0519	Karanti Chandra Lekha	Chandra Lekha	Chandra Lekha	Chandra Lekha
22	19UP1A0520	Komati Reddy Shreya Reddy	Shreya	Shreya	Shreya
23	19UP1A0521	Komati Reddy Sowjanya	Sowjanya	Sowjanya	Sowjanya
24	19UP1A0522	KovuriRadha	Radha	Radha	Radha
25	19UP1A0523	KuntigorlaTejaswini	Tejaswini	Tejaswini	Tejaswini
26	19UP1A0524	KyathamPravalika	Pravalika	Pravalika	Pravalika



PRINCIPAL  
 Vignans Institute of Management & Technology For Women  
 Kondapur (V), Ghatkesar (M), Medchal-Malkajgiri (D)-501301  
 Telangana State

27	19UPIA0525	Likitha Pawar	Likitha	Likitha	Likitha
28	19UPIA0526	M Gouthami	Gouthami	Gouthami	Gouthami
29	19UPIA0527	Maradugu Poojitha	Poojitha	Poojitha	Poojitha
30	19UPIA0528	Monica Mahendra Nunsavath	Monica	Monica	Monica
31	19UPIA0529	Moddasani Sneharshitha	Sneharshitha	A	Sneharshitha
32	19UPIA0530	Mylapally Amulya	Amulya	Amulya	Amulya
33	19UPIA0531	N Soniya	Soniya	Soniya	Soniya
34	19UPIA0532	Nakirekanti Sathvika	Sathvika	Sathvika	Sathvika
35	19UPIA0533	Nalla Nithila	Nithila	Nithila	Nithila
36	19UPIA0534	Nindanampally Vaishnavi	Vaishnavi	Vaishnavi	A
37	19UPIA0535	P Akhila	Akhila	Akhila	Akhila
38	19UPIA0536	Pemmasani Sowmya	Sowmya	Sowmya	Sowmya
39	19UPIA0537	Padala Prasanna Lahari	Lahari	Lahari	Lahari
40	19UPIA0538	Pagadala Gayathri	Gayathri	Gayathri	Gayathri
41	19UPIA0539	Pati Srimukhi	Srimukhi	Srimukhi	Srimukhi
42	19UPIA0540	Pittala Sanjana	Sanjana	Sanjana	Sanjana
43	19UPIA0541	Pola Amba Bhavani	Bhavani	Bhavani	Bhavani
44	19UPIA0542	Mansi Polaveni	Mansi	Mansi	Mansi
45	19UPIA0543	Punem Keerthi	Keerthi	Keerthi	Keerthi
46	19UPIA0544	Rebbana Shivani	Shivani	Shivani	Shivani
47	19UPIA0545	Rudroju Meghana	Meghana	A	Meghana
48	19UPIA0546	S Akshitha Bhavani	Bhavani	Bhavani	Bhavani
49	19UPIA0547	S Shravani Goud	Shravani	Shravani	Shravani
50	19UPIA0548	Sandhireddy Meghana	Meghana	Meghana	Meghana
51	19UPIA0549	Shailaja Arige	Arige	Arige	Arige
52	19UPIA0550	Varkala Sai Deepthi	Deepthi	Deepthi	Deepthi
53	19UPIA0551	Yeshaboina Shireesha	Shireesha	Shireesha	Shireesha
54	19UPIA0552	Akshanthala Sathvika	Sathvika	Sathvika	Sathvika
55	19UPIA0553	Andekar Easha	Easha	Easha	Easha



PRINCIPAL  
Vignani's Institute of Management & Technology For Women  
Kondapur (V), Ghatkesar (M), Medchal-Malkajgiri (Dt)-501301  
Telangana State

56	19UP1A0554	AnnaldesiSravika	Sravika	Sravika	Sravika
57	19UP1A0555	AvuthaKiranmai	Kiran	Kiran	Kiran
58	19UP1A0556	AyiluriSravani	Sravani	Sravani	Sravani
59	19UP1A0557	BattarGayatriSravani	G	G	A
60	19UP1A0558	BeeravalliSwapna	Swapna	Swapna	Swapna

*N. Indira*  
**HOD-CSE**

Head of the Department  
 Computer Science and Information Technology  
 Vignan's Institute of Management & Technology For Women  
 Kondapur (V), Ghatkesar (M), Medchal-Malkajgiri (Dist)-501301  
 Telangana State

*[Signature]*  
**PRINCIPAL**

Vignan's Institute of Management & Technology For Women  
 Kondapur (V), Ghatkesar (M), Medchal-Malkajgiri (Dist)-501301  
 Telangana State





# VIGNAN'S INSTITUTE OF MANAGEMENT AND TECHNOLOGY FOR WOMEN

(Sponsored by Lavu Educational Society)

Approved by AICTE, New Delhi & Affiliated to JNTUH, Hyderabad.

**Kondapur (V), Ghatkesar (M), Medchal - Malkajgiri (D) - 501 301**

Accredited By



In association with:



## CERTIFICATE OF PARTICIPATION

This certificate is presented to Ms. P. SOWMYA.....  
for her participation in a workshop on **"Pattern Recognition"** held from  
**4th -6th November, 2019**, Organized by the Department of Computer  
Science and Engineering, in association with Samskruti College of  
Engineering & Technology, Hyderabad.

  
Co-Ordinator

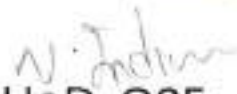

  
HoD, CSE

  
PRINCIPAL  
Vignan's Institute of Management & Technology For Women,  
Kondapur (V), Ghatkesar (M), Medchal-Malkajgiri (Dt)-501301  
Telangana State

  
Principal





# VIGNAN'S INSTITUTE OF MANAGEMENT AND TECHNOLOGY FOR WOMEN

Sponsored by Lawu Educational Society, Approved by AICTE, New Delhi & Affiliated to JNTUH, Hyderabad.  
Kondapur (V), Ghatkesar (M), Medchal - Malkajgiri (D) - 501 301 Phone: +91 96529 10002/3



VMTW/CSE/CIR/2018-19/I/03

Date: 18/12/2019

## CIRCULAR

This is to inform all the HOD's, staff and students that there is a three days workshop on "GAME THEORY AND PRACTICES USING AI" from 19-12-2019 to 21-12-2019. The seminar will be conducted by CSE Department. Hereby, request everyone to attend the workshop to make it a successful.

  
PRINCIPAL

Copy to:

1. CEO for information,
2. IQAC,
3. Admin Office,
4. HODs (CSE, IT, ECE, EEE, BSH),
5. All Notice Boards
6. Circulate to all Class Rooms,
7. File.



  
PRINCIPAL  
Vignani's Institute of Management & Technology For Women  
Kondapur (V), Ghatkesar (M), Medchal-Malkajgiri (D) - 501301  
Telangana State



# VIGNAN'S INSTITUTE OF MANAGEMENT AND TECHNOLOGY FOR WOMEN

(Sponsored by Lavu Educational Society)  
Approved by AICTE, New Delhi & Affiliated to JNTUH, Hyderabad.  
Kondapur (V), Ghatkesar (M), Medchal - Malkajgiri (D) - 501 301



## DEPARTMENT OF COMPUTER SCIENCE AND ENGINEERING

ORGANIZING

### A WORKSHOP ON

# GAME THEORY AND PRACTICES USING AI

19<sup>TH</sup> - 21<sup>ST</sup> DECEMBER, 2019 @ SEMINAR HALL



Resource Person:

**Mr. G. Venkata Rao,**  
Associate, Techfort Solutions,  
Hyderabad.

In association with:



**Chief Patron:**

**Dr. Lavu Rathalah,**  
Chairman, Vignan Group.

**Patron:**

**Mr. B. Shraavan,**  
CEO, Vignan Group.

**Co-Patron:**

**Dr. K. Chandra Shekar,**  
Principal, VMTW.

**Advisor:**

**Mrs. V. Indrani,**  
Associate Professor & HOD,  
Dept. of CSE.

**Co-Ordinator:**

**Mr. S. Dilli Babu,**  
Assistant Professor, CSE.  
Cell: +91 96529 10002



*AA*  
PRINCIPAL

Vignan's Institute of Management & Technology For Women  
Kondapur (V), Ghatkesar (M), Medchal-Malkajgiri (D)-501301  
Telangana State



# VIGNAN'S INSTITUTE OF MANAGEMENT AND TECHNOLOGY FOR WOMEN

Sponsored by Lavu Educational Society, Approved by AICTE, New Delhi & Affiliated to JNTUH, Hyderabad.  
Kondapur (V), Ghatkesar (M), Medchal - Malkajgiri (D) - 501 301 Phone: +91 96529 10002/3



## DEPARTMENT OF COMPUTER SCIENCE AND ENGINEERING

### Report on "GAME THEORY AND PRACTICES USING AI"

Date: 24-12-2019

**Event Type** : Workshop  
**Total No. of Participants** : 103  
**Resource Person** : Venkata Rao Ganipishetty,  
Techfort Solutions  
**Name of Coordinator** : S.Dilli Babu  
**Date & Time** : 19-12-2019 to 21-12-2019  
10:00AM to 4:00PM

#### **Objective of the Event:**

The Main objective of Game Theory and Practices using Artificial Intelligence is to analyze strategic interactions, optimize resource allocation, design effective mechanisms, perform game-theoretic analysis, and develop intelligent agents for multi-agent systems.



#### **Outcomes of the Event:**

The outcome of combining game theory and AI is to leverage the insights and techniques from both fields to enhance decision-making, optimize resource allocation, design effective mechanisms, gain insights into complex systems, and develop intelligent agents for



  
PRINCIPAL  
Vignan's Institute of Management & Technology For Women  
Kondapur (V), Ghatkesar (M), Medchal-Malkajgiri (Dt)-501301  
Telangana State



# VIGNAN'S INSTITUTE OF MANAGEMENT AND TECHNOLOGY FOR WOMEN

Sponsored by Layu Educational Society, Approved by AICTE, New Delhi & Affiliated to JNTUH, Hyderabad.  
Kondapur (V), Ghatkesar (M), Medchal - Malkajgiri (D) - 501 301 Phone: +91 96529 10002/3



multi-agent systems. These outcomes can have applications in various domains, including economics, social sciences, engineering, or computer science.

After completion of the workshop the students can develop intelligent agents that make better strategic decisions in competitive or cooperative scenarios. These agents can learn optimal strategies, adapt to changing

Environments, and exploit the weaknesses of opponents. The outcome is more effective decision-making in game-like situations, leading to improved performance, higher rewards, or increased chances of success.

Total 103 Number of members and 6 numbers of Staff had participated in the workshop.

This workshop session had provided an excellent opportunity to learn about **GAME THEORY AND PRACTICES USING AI** to all the participants.

  
**Coordinator**

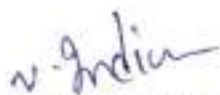

  
**Head of Department**

Head of The Department  
Computer Science and Engineering  
Vignan's Institute of Management & Technology For Women  
Kondapur (V), Ghatkesar (M), Medchal-Malkajgiri (Dt)-501301  
Telangana State

  
PROFESSOR

Vignan's Institute of Management & Technology For Women  
Kondapur (V), Ghatkesar (M), Medchal-Malkajgiri (Dt)-501301  
Telangana State

Student attendance list of three days workshop on GAME THEORY AND PRACTICES USING AI

A.Y 2021-2022

III YEAR B.TECH (CSE)

S.No	Roll No	STUDENT NAME	19-dec	20-dec	21-dec
1	14UP1A0505	B.Meghana	Megha	Megha	Megha
2	15UP1A0501	Annarapu Hima Rajyalakshmi	A	Hima	Hima
3	15UP1A0502	Basude Preethi	Preethi	Preethi	A
4	15UP1A0503	Bayyadugula Praveena	Praveena	Praveena	Praveena
5	15UP1A0504	Beenamohina Tejasvee Yadav	Tejasvi	A	Tejasvi
6	15UP1A0505	Bodika Sandhya Rani	Sandhya	Sandhya	Sandhya
7	15UP1A0506	Bolloju Ramya Smruthi	Ramya	Ramya	A
8	15UP1A0507	Bomma Akhila	Akhila	Akhila	Akhila
9	15UP1A0508	Bonthu Taruna Sri	Taruna	Taruna	Taruna
10	15UP1A0509	Burugu Tejasri	Tejasri	Tejasri	Tejasri
11	15UP1A0510	Chennala Gayatri Yadav	A	Gayatri	A
12	15UP1A0511	Chindam Pranava	Pranava	Pranava	Pranava
13	15UP1A0512	Chowdarapu Srija	Srija	Srija	Srija
14	15UP1A0513	D A Divya	Divya	Divya	A
15	15UP1A0514	D Anusha	Anusha	Anusha	Anusha
16	15UP1A0515	Damuluri Divya	Divya	Divya	A
17	15UP1A0517	Dendukuru Sirekha	A	Sirekha	Sirekha
18	15UP1A0518	Dharni Manisha	Manisha	Manisha	Manisha
19	15UP1A0519	G Vaishnavi	Vaishnavi	Vaishnavi	Vaishnavi
20	15UP1A0520	Golem Supraja Chinmayee	Chinmayee	Chinmayee	Chinmayee
21	15UP1A0522	Gullipalli Jahnvi	Jahnvi	Jahnvi	Jahnvi
22	15UP1A0523	Gunda Sowmya	Sowmya	Sowmya	Sowmya
23	15UP1A0524	Gurdeep Kaur Jandu	Kaur	A	Kaur



PRINCIPAL  
Vignans Institute of Management & Technology For Women  
Kondapur (M), Ghatkesar (M), Medchal-Malkajgiri (Dist. Medchal)  
Telangana State

24	15UP1A0525	K Anusha	Anusha	Anusha	Anusha
25	15UP1A0526	K Shruthi	Shruthi	Shruthi	Shruthi
26	15UP1A0528	Kambalapally Mounika	Mounika	Mounika	Mounika
27	15UP1A0529	Kotika Siva Parvathi	Parvathi	Parvathi	Parvathi
28	15UP1A0530	Krishnadhari Sowjanya	Sowjanya	Sowjanya	Sowjanya
29	15UP1A0532	Manjula Digamber Devkatte	Manjula	Manjula	Manjula
30	15UP1A0533	Marpu Swetha Reddy	Swetha	Swetha	Swetha
31	15UP1A0534	Moguluru Venkata Nagaswetha	Nagaswetha	Nagaswetha	Nagaswetha
32	15UP1A0535	N Niharika Reddy	Niharika	Niharika	Niharika
33	15UP1A0536	Nakrekanti Prashanthi	Prashanthi	Prashanthi	Prashanthi
34	15UP1A0537	Nerella Tejaswini	Tejaswini	Tejaswini	Tejaswini
35	15UP1A0538	Padmam Krishnaveni	A	Padmam	Padmam
36	15UP1A0539	Panaganti Madhushalini	Madhus	Madhus	Madhus
37	15UP1A0540	Potham Jyoshna Devi	Jyoshna	Jyoshna	Jyoshna
38	15UP1A0541	Pulamoni Pravalika	Pravalika	Pravalika	A
39	15UP1A0542	Pulgam Kavya	Kavya	Kavya	Kavya
40	15UP1A0544	Sarikonda Pooja	Pooja	Pooja	Pooja
41	15UP1A0545	Sravani Reddy Barlapally	Sravani	Sravani	Sravani
42	15UP1A0546	Sri Rama Vineetha	Vineetha	Vineetha	A
43	15UP1A0547	Sunkara Salmounika	Sunkara	Sunkara	A
44	15UP1A0549	Swargam Mounika	Mounika	Mounika	Mounika
45	15UP1A0550	Thoutam Chandana	Chandana	Chandana	A
46	15UP1A0551	Valaboju Divya Sri	Divya	Divya	A
47	15UP1A0552	Akula Vanaja	Vanaja	Vanaja	Vanaja
48	15UP1A0553	Akuula Priyanka	Priyanka	Priyanka	Priyanka
49	15UP1A0554	Ananthula Ravali	Ravali	Ravali	Ravali
50	15UP1A0555	Andam Sirisha	A	A	A



PRINCIPAL  
Vignani's Institute of Management & Technology For Women  
Kondapur (V), Ghatakasari (M), Medchal-Malkajgiri (Dt) 501301  
Telangana State

51	15UP1A0556	Bandi Rashmitha	Rash	Rash	Rash
52	15UP1A0557	Bareddy Sravanthi	Sravan	Sravan	Sravan
53	15UP1A0559	Boppidi Roopasri	Roopa	A	Roopa
54	15UP1A0560	Chanda Varalaxmi	Vara	Vara	A
55	15UP1A0562	Chiraboina Ramadevi	Rama	Rama	Rama
56	15UP1A0563	Chowdavarapu Lakshmi Priya	Laksh	Laksh	Laksh
57	15UP1A0564	Daripalli Amani	Amani	Amani	Amani
58	15UP1A0565	Edukulla Likitha	Likitha	Likitha	Likitha
59	15UP1A0567	Gopishetty Sahaja	Sahaja	Sahaja	Sahaja
60	15UP1A0568	K Nava Jyothi	Jyothi	Jyothi	Jyothi
61	15UP1A0569	Kandula Manmitha	Mani	Mani	Mani
62	15UP1A0570	Karla Amulya	Amulya	Amulya	Amulya
63	15UP1A0571	L Sonali	Sonali	A	Sonali
64	15UP1A0572	Mandadi Mounika	Mounika	Mounika	A
65	15UP1A0573	Maryala Dikshitha	Dikshitha	Dikshitha	Dikshitha
66	15UP1A0574	Mende Kavya	Kavya	A	Kavya
67	15UP1A0575	Miryala Sri Lakshmi	Sri	Sri	Sri
68	15UP1A0576	Moola Vidya Sri	Vidya	Vidya	Vidya
69	15UP1A0577	N Usharani	Ushara	Ushara	Ushara
70	15UP1A0578	Nandini Bandaru	Nandini	Nandini	Nandini
71	15UP1A0579	Nangunuri Navya Sri	Navya	Navya	A
72	15UP1A0580	Pendyala Lasya Priya	Lasya	Lasya	Lasya
73	15UP1A0581	Pininti Niharika Reddy	Niharika	Niharika	A
74	15UP1A0582	Putta Deekshitha	Deekshitha	A	Deekshitha
75	15UP1A0583	Ramadevi Seelam	Seelam	Seelam	Seelam
76	15UP1A0584	Ravalkole Manasa	Manasa	Manasa	Manasa
77	15UP1A0585	Ravirala Harshitha	Harshitha	Harshitha	Harshitha



PRINCIPAL  
Vignans Institute of Management & Technology For Women  
Kondapur (V), Ghatkesar (M), Medchal-Malkajgiri (D), Pin-501301  
Telangana State

78	15UP1A0586	Relangi Vijaya Durga	Durga	Durga	Durga
79	15UP1A0587	Sagireddy Hevanya	Hevanya	Hevanya	Hevanya
80	15UP1A0588	Samala Anusha	A	A	A
81	15UP1A0589	Santhapuri Vaishnavi	Vaishnavi	Vaishnavi	Vaishnavi
82	15UP1A0590	Soma Shruthi	Shruthi	Shruthi	Shruthi
83	15UP1A0591	Sumreddy Abhinaya	Abhinaya	A	Abhinaya
84	15UP1A0592	Sunkari Sowmya Reddy	Sowmya	Sowmya	A
85	15UP1A0593	Talapareddy Sanghavi	Sanghavi	Sanghavi	Sanghavi
86	15UP1A0594	Thirmani Bhavani	Bhavani	Bhavani	Bhavani
87	15UP1A0595	Veeranala Manasa	Manasa	Manasa	Manasa
88	15UP1A0596	Velapati Sowmya	Sowmya	Sowmya	Sowmya
89	15UP1A0598	Vemi Reddy Lakshmi Kalyani	Lakshmi Kalyani	Lakshmi Kalyani	Lakshmi Kalyani
90	15UP1A0599	Vodde Divya	Divya	A	Divya
91	15UP1A05A1	Vootukury Pravallika	Pravallika	Pravallika	Pravallika
92	15UP1A05A2	Voruganti Pravallika	Pravallika	A	Pravallika
93	15UP1A05A3	Mahveen Arshi	Arshi	Arshi	Arshi
94	14UP1A0505	B.Meghana	Meghana	Meghana	Meghana
95	15UP1A0501	Annvarapu Hima Rajyalakshmi	Hima Rajyalakshmi	Hima Rajyalakshmi	Hima Rajyalakshmi
96	15UP1A0502	Basude Preethi	Preethi	Preethi	Preethi
97	15UP1A0503	Bayyadugula Praveena	Praveena	Praveena	Praveena
98	15UP1A0504	Beenamohina Tejasvee Yadav	Tejasvee	Tejasvee	Tejasvee
99	15UP1A0505	Bodika Sandhya Rani	Rani	Rani	A
100	15UP1A0506	Bolloju Ramya Smruthi	Smruthi	Smruthi	Smruthi
101	15UP1A0507	Bomma Akhila	Akhila	Akhila	Akhila
102	15UP1A0508	Bonthu Taruna Sri	Taruna	Taruna	Taruna
103	15UP1A0509	Burugu Tejasri	Tejasri	Tejasri	Tejasri

CO-ORDINATOR



PRINCIPAL  
Vignans Institute of Management & Technology For Women  
Kondapur (V), Ghatkesar (M), Medchal-Malkajgiri (D)-501301  
Telangana State





# VIGNAN'S INSTITUTE OF MANAGEMENT AND TECHNOLOGY FOR WOMEN

(Sponsored by Lavu Educational Society)

Approved by AICTE, New Delhi & Affiliated to JNTUH, Hyderabad.

Kondapur (V), Ghatkesar (M), Medchal - Malkajgiri (D) - 501 301

Accredited By



In association with:



## CERTIFICATE OF PARTICIPATION

This certificate is presented to Ms. ....*Bomma*.....*AKHILA*.....  
for her participation in a workshop on "**Game Theory and Practices using AI**" held on **19th - 21st December, 2019**, Organized by the Department of Computer Science and Engineering, in association with TechFort Software Services Pvt. Ltd. Hyderabad.

*Durb*  
Co-Ordinator



*V. Indira*  
HoD, CSE

*V. Indira*  
PRINCIPAL  
Vignan's Institute of Management & Technology For Women  
Kondapur (V), Ghatkesar (M), Medchal-Malkajgiri (D)-501301  
Telangana State

*V. Indira*  
Principal



**DEPARTMENT OF ELECTRONICS AND COMMUNICATION ENGINEERING**

VMTW/ECE/WS/CIR/2021-22/1/2

Date: 09-11-2021

**CIRCULAR**

This is to inform all the III B.Tech ECE Students that there will be a Workshop on entitled "Analog VLSI Chip Design" in Association with **Deeksha Technologies** by **Mr. P. Hari Prasad** from 11-11-2021 to 12-11-2021 at B-Block Seminar Hall. All students are invited to take part in this Workshop. The participating students will be honored with certificates of participation.

During the Workshop you will be encouraged to interact with the speaker and the other participants through the case study discussions.

  
HOD

Copy to:

The Principal, for kind information

IQAC

Dept. File

Circular to III ECE Class Room



  
PRINCIPAL  
Vignan's Institute of Management & Technology For Women  
Kondapur(V), Ghalkesar(M), Medchal-Malkajgiri(D)-501301  
Telangana State

Request to conduct a workshop in our college

Dept. of ECE VMTW <ece@vmtw.in>

10:00 AM To: <hariprased.peta@gmail.com>

Mon November, 8th, 2021 at

Respected sir,

I am Mr. P.Harikrishna, HOD , Dept of ECE , Vignan's Institute Of Management And Technology For Women. Ghatkesar, Hyderabad, Telangana. We are planning to conduct a two day workshop on "Analog VLSI Chip Design" on 11<sup>th</sup> and 12<sup>th</sup> November 2021 to enhance the knowledge of the students. I request to send approval for conducting workshop

Thanking you

Thanks Regards  
P.Harikrishna  
Assoc. Prof & HOD,  
Dept. of ECE, VMTW  
Contact: 7093246048



PRINCIPAL  
Vignan's Institute of Management & Technology For Women  
Gondapur(V), Ghatkesar(M), Medchal-Malkajgiri(WDI)-501301  
Telangana State



DEEKSHA TECHNOLOGIES <hariprased.peta@gmail.com>

## Regarding work shop approval

DEEKSHA TECHNOLOGIES <hariprased.peta@gmail.com>

09,November,2021 at 11:02 AM

To: Dept. of ECE VMTW <ece@vmtw.in>

Sir/Madam,

Sub: approved for organizing workshop

Hence further enhancement of students knowledge we have approved the organization to conduct a two day workshop on "Analog VLSI Chip Design".

With Regards,

DEEKSHA TECHNOLOGIES  
hariprased.peta@gmail.com



PRINCIPAL

Vignan's Institute of Management & Technology For Women  
Ghatkesar(V),Ghatkesar(M),Medchal-Malkajgiri District-501301

# REGISTRATION FORM

Name: .....

Date of Birth & Age: .....

Gender (M/F): .....

Qualifications: .....

Institution: .....

Affiliating University: .....

Address for Communication: .....

Phone Nos. ....

Office: .....

Personal: .....

Email: .....

**LAST DATE FOR REGISTRATION: 27<sup>TH</sup> APRIL, 2022**

Resource Person:  
**Mr. P. Hari Prasad,**  
Deeksha Technologies,  
Hyderabad.

Chief-patrons:  
**Dr. L. Rathaiah,**  
Chairman,  
Vignan Group of Institutions.

**Mr. B. Shravan,**  
Chief Executive Officer,  
Vignan Group of Institutions

Patron:  
**Dr. G. Apparao Naidu,**  
Principal, VMTW

**Mr. P. Harikrishna,**  
Associate Professor & Head of the Department,  
Dept. of ECE.

Co-ordinator:  
**Mr. Pullaiah Thanam**  
Associate Professor, Dept. of ECE,  
Contact No: +91 96425 64980

Student Co-ordinator:  
**Ms. Tankala Harika**  
Contact No: +91 95503 92403

**Ms. Nattuva Bhargavi**  
Contact No: +91 80965 33999



[www.vmtw.in](http://www.vmtw.in)

# VIGNAN'S INSTITUTE OF MANAGEMENT AND TECHNOLOGY FOR WOMEN

(Sponsored by Law Educational Society)  
Approved by AICTE, New Delhi & Affiliated to JNTUH, Hyderabad.  
Kondapur (V), Ghatkesar (M), Medchal - Malkajgiri (D) - 501 30

## A TWO DAY WORKSHOP ON "ANALOG VLSI CHIP DESIGN" 11<sup>TH</sup> & 12<sup>TH</sup> NOVEMBER, 2021

VENUE:  
**'B'-BLOCK SEMINAR HALL, VMTW**

ORGANIZED BY:  
**DEPARTMENT OF ELECTRONICS AND  
COMMUNICATION ENGINEERING**



**PRINCIPAL**  
Vignan's Institute of Management & Technology  
Kondapur (V), Ghatkesar (M), Medchal - Malkajgiri (D)  
Telangana - 501301

## ABOUT THE INSTITUTION

Vignan's Institute of Management and Technology for Women (VMTW), is the brainchild of Dr. L. Rathalah, Chairman, Vignan Group of Institutions, which was founded in August 2008, with four branches of Engineering.

VMTW is an exemplary institution of higher learning with a mission of pursuing excellence in education and research. The institution, with its diverse and dynamic community of about 2000 students offers a distinctive combination of some of the finest facilities for 7 different graduate, and undergraduate programs, accomplished faculty, world-class facilities with a hostel set on a sprawling area of 22 acres sylvan surroundings of mango groves and greenery.

While students at VMTW immerse themselves in academics, the college has a lot in store for them outside the classroom. Student life includes participation in sports, recreational & co-curricular, and cultural activities. In short, at VMTW students will find an academic and social environment where everyone from faculty members to peers helps shape their future.

VMTW is a home to aesthetically designed buildings with state-of-the-art computer and internet facilities, modern laboratories, workshops, seminar halls, auditoriums, and well-stocked libraries, sports, and games fields.

The institution boasts of a strong alumni network with alumni events held every year serving as a platform for past students to give back to VMTW and share their experiences with its present fellow students. With so much to offer, it is only natural that students of VMTW get a unique opportunity to carve a niche for themselves in their chosen field of study. It enables them to become well-rounded and discerning citizens, fully qualified for their chosen professions in the workplace. Institute also brings out the creativity in students by imparting engineering knowledge imbuing interpersonal skills to promote innovation, research, and entrepreneurship.

## ABOUT THE DEPARTMENT

Department of Electronics and Communication Engineering was started since the inception of Vignan's Institute of Management and Technology for Women during 2008 with an initial intake of 90. The strength was enhanced to 120 during 2010. The Department had added Post graduate programme in VLSI during the year 2011 and Embedded Systems during 2014 with an intake of 18 each.

The Department has state-of-art laboratories equipped with advanced and well maintained equipment, continuously updated application software packages, more than adequate computing systems with 24x7, 30 MBPS internet facility.

## ABOUT THE COURSE

The goal of the workshop is to introduce the students to the main principles of the MOS transistor implementation, the basic VLSI analog design flow, and the Cadence analog design environment. The students will learn how to draw schematics, run different types of analog simulations and how to draw and verify layout.

## COURSE OBJECTIVES

Analog design in the context of integrated circuit (IC) design is a discipline that focuses on the creation of circuits that operate in and are optimized for continuous time-domain behavior. Typical objectives of analog design include:

## EXPECTED OUTCOMES

At the end of Workshop, participants will be able to

- Develop a high-level specification for the design. What functions will it perform? What are the performance, power, and area (i.e., cost) targets for the design?
- Develop a top-level design to achieve the required results using macro-functions such as filters, comparators, and amplifiers.



*ASH*  
PRINCIPAL

Vignan's Institute of Management & Technology For Women  
Kondapur(V), Ghatkesar(M), Madhwal-Madhapalle, District of  
Telangana State



# VIGNAN'S INSTITUTE OF MANAGEMENT AND TECHNOLOGY FOR WOMEN

Sponsored by Lavu Educational Society, Approved by AICTE, New Delhi & Affiliated to JNTUH, Hyderabad.  
Kondapur (V), Ghatkesar (M), Medchal - Malkajgiri (D) - 501 301 Phone: +91 96529 10002/3



## WORKSHOP ON

# ANALOG VLSI CHIP DESIGN

## 11<sup>TH</sup> & 12<sup>TH</sup> NOVEMBER, 2021

### DEPARTMENT OF ELECTRONICS AND COMMUNICATION ENGINEERING



*Adh*  
PRINCIPAL  
Vignans Institute of Management & Technology For Women  
Kondapur(V), Ghatkesar(M), Medchal-Malkajgiri(D)-501301  
Telangana State



# VIGNAN'S INSTITUTE OF MANAGEMENT AND TECHNOLOGY FOR WOMEN

(Sponsored by Lavu Educational Society)

Approved by AICTE, New Delhi & Affiliated to JNTUH, Hyderabad.

Kondapur (V), Ghatkesar (M), Medchal - Malkajgiri (D) - 501 301

Accredited By



## CERTIFICATE OF PARTICIPATION

This certificate is presented to

.....

for her participation in a Two Day Workshop on  
"Analog VLSI Chip Design" held from 11-11-2021 to 12-11-2021,  
Organized by the Department of Electronics and  
Communication Engineering.

Coordinator



HoD, ECE

*Ash*  
PRINCIPAL  
Vignans Institute of Management & Technology For Women





Vignan's Institute Of Management and Technology For Women

Work shop on "Analog VLSI Chip Design"

III B.Tech II sem Students List-2021-22

Branch :ECE-A



S. No	Hall Ticket No	Student Name	Sign of the student- 11/11/21	Sign of the student- 12/11/21
1	19UP1A0401	ARKALA SNEHA REDDY	Sneha	Sneha
2	19UP1A0402	BANDI RASAGNA	Rasagna	Rasagna
3	19UP1A0403	BASWA VIGNATHA	Vignatha	Vignatha
4	19UP1A0404	BELLI PAVANI	Pavani	Pavani
5	19UP1A0405	B V SHIVA KEERTHIKA	Kee	Kee
6	19UP1A0406	DIWAKARLA SAI LAKSHMI SRAVYA	Suf	Suf
7	19UP1A0407	GAJULA ABHIGNA	Abhigna	Abhigna
8	19UP1A0408	GADDAM LIKHITHA	Likhitha	Likhitha
9	19UP1A0409	GIRUGUBOTHALA SAI DEEPTHI	Saidcepthi	Saidcepthi
10	19UP1A0410	GOLLA PRIYANKA	priyanka	priyanka
11	19UP1A0411	GOURISHETTI SWETHA	Suf	Suf
12	19UP1A0412	KOPPELA NISHITHA	Nishitha	Nishitha
13	19UP1A0413	KALAVA CHARITHA	charitha	charitha
14	19UP1A0414	KALVA MAHATHEE REDDY	maee	maee
15	19UP1A0415	KANDE LAHARI	Lahari	Lahari
16	19UP1A0416	KANDULA MEGHANA	Meghana	Meghana
17	19UP1A0417	KONAKANCHI TEJASWINI	Tej	Tej
18	19UP1A0418	KUNCHETTI PRAVALIKA	Pravalika	Pravalika
19	19UP1A0419	LINGAMPALLY ABHINAYA	Abhinaya	Abhinaya
20	19UP1A0420	MANNE SRAVANI	Lavanya	Lavanya
21	19UP1A0421	NAKKA LAVANYA	Lavanya	Lavanya
22	19UP1A0422	NEELAM MOHANA PRIYA	AB	AB
23	19UP1A0423	PUSHADAPU LAVANYA	Lavanya	Lavanya
24	19UP1A0424	PALLE PAVANI	Pavani	Pavani
25	19UP1A0425	PARIMI PRASANNA LAXMI	Laxmi	Laxmi



PRINCIPAL

Vignan's Institute of Management & Technology For Women  
Kondapur(V), Ghatkesar(M), Madchal-Walkajiri(D)-501  
Telangana State

26	19UP1A0426	P SINDHU	Sindhu	Sindhu
27	19UP1A0427	RAJPUTH MAHESHWARI SINGH	AB	AB
28	19UP1A0428	ROWTHU PALLAVI	Pallavi	Pallavi
29	19UP1A0429	SYED TABASSUM	Tabassum	Tabassum
30	19UP1A0430	SAKSHI JAYASREE BHAVANI	AB	AB
31	19UP1A0431	SANGOJU SATHWIKA	Sathwika	Sathwika
32	19UP1A0432	SEETHAMMAGARI ANITHA	Anitha	Anitha
33	19UP1A0433	SIVVA AKSHAYA	Akshaya	Akshaya
34	19UP1A0434	SRIPADA JITYA LAKSHMI YESASWINI	Laxmi	Laxmi
35	19UP1A0435	SUGGUNA LIKHITA	Likhita	Likhita
36	19UP1A0436	TANKALA HARIKA	Harika	Harika
37	19UP1A0437	THOOMU SREYA REDDY	Sreyal	Sreya
38	19UP1A0438	UPPULA SHUVALEELA	Shuvaleela	Shuvaleela
39	19UP1A0439	VANAM ASHVITHA REDDY	AB	AB
40	19UP1A0440	VANKUDOTH SANGITHA	Sangitha	Sangitha
41	19UP1A0441	V LAXMI VASUNDHARA	Vasundhara	Vasundhara
42	19UP1A0442	YARASURI GAYATHRI MANASA	Manasa	Manasa
43	20UP5A0401	AKKI PRATHIMA BHARATHI	AB	AB
44	20UP5A0402	EDUGU RAJITHA	Rajitha	Rajitha
45	20UP5A0403	GODAVARTHI ANUSHA	Anusha	Anusha
46	20UP5A0404	GOKA ANUSHA	Anusha	Anusha
47	20UP5A0405	GOPI VARSHA	Varsha	Varsha
48	20UP5A0406	JUPALLY NAVYA SRI	Navyasri	Navyasri
49	20UP5A0407	KOLA CHETHANA	Chetha	Chetha
50	20UP5A0408	KOTTHUR DEVI	Devi	Devi
51	20UP5A0409	MUPPANENI SOWMIKA	Sowmya	Sowmya

*Selling*  
COORDINATOR

*[Signature]*  
ECE, HOD

Head of the Department

Electronics and Communication Engineering  
Finnor's Institute of Management & Technology  
Kandur (V), Chittoor (M), Madhya Pradesh (R)-507301



*[Signature]*  
Finnor's Institute of Management & Technology  
Kandur (V), Chittoor (M), Madhya Pradesh (R)-507301  
Telangana



Vignana's Institute Of Management and Technology For Women

Work shop on "Analog VLSI Chip Design"

III B.Tech II sem Students List-2021-22

Branch :ECE-B



S. No	Hall Ticket No	Student Name	Sign of the student- 11/11/21	Sign of the student- 12/11/21
1	19UP1A0443	ANNU PRAGATHI	Pragathi	Pragathi
2	19UP1A0444	ANUMOJU KAVYA	Kavya	Kavya
3	19UP1A0446	BANALA SNITHIKA	Snithika	Snithika
4	19UP1A0447	BHIMAVARAPU SIVA NAGA SAI SARANYA	Saranya	Saranya
5	19UP1A0448	BOGALA ANUSHA	Anusha	Anusha
6	19UP1A0449	BOKKA HARSHITHA	Harshitha	Harshitha
7	19UP1A0450	BOKKA VARSHITHA	Varshitha	Varshitha
8	19UP1A0451	BOLLEPALLY JASHANVI	Jashanvi	Jashanvi
9	19UP1A0452	CHIMATA MADHAVI	Madhavi	Madhavi
10	19UP1A0453	DASI VENKATA SAHITHAYA	AB	AB
11	19UP1A0454	DUGYALA VAISHNAVI	AB	AB
12	19UP1A0455	G.SHIRISHA	Shirisha	Shirisha
13	19UP1A0456	GABALE NISHITHA	AB	AB
14	19UP1A0457	GOURISHETTI HARSHA VARDHINI	Vardhini	Vardhini
15	19UP1A0458	GUMAMALA SNEHA REDDY	AB	AB
16	19UP1A0459	HALDODDI DIVYA	Divya	Divya
17	19UP1A0460	JANJIRALA ANUSHA	Anusha	Anusha
18	19UP1A0461	KARKURI SOWMYA	AB	AB
19	19UP1A0462	KALYANAM MOUNIKA	Mounika	Mounika
20	19UP1A0463	KOMMINENI JASMITHA	AB	AB
21	19UP1A0464	KONDERU SRAVYA	Sravya	Sravya
22	19UP1A0465	LAKAMGARI PRASANNA LAXMI REDDY	AB	AB
23	19UP1A0466	GADDAM LIKHITHA	Likhitha	Likhitha
24	19UP1A0467	LIMBURE SANTHOSHI	AB	AB
25	19UP1A0468	MALGIREDDY YOGITHA REDDY	Yogitha	Yogitha
26	19UP1A0469	MARVALA DEEPIKA	Deepika	Deepika



PRINCIPAL  
Vignana's Institute of Management & Technology For Women  
Kondapur(V), G.H. P.O. Medchal-Malkajgiri(Dt)-501301  
Telangana State

27	19UP1A0470	MEDA BHUVANESWARI	AB	DB
28	19UP1A0471	PADAKULA UMA	Uma	Uma
29	19UP1A0472	RAMIDI DEEKSHITHA	Deekshitha	Deekshitha
30	19UP1A0473	RAVULA HIRANMAI	Hiranmai	Hiranmai
31	19UP1A0474	SHANIGALA CHANDANA	Chandana	Chandana
32	19UP1A0475	MORAPALLY SIRI CHANDANA REDDY	AB	DB
33	19UP1A0476	SUROJU SRIVAISHNAVI	SSrivaishnavi	SSrivaishnavi
34	19UP1A0477	TELUKUNTLA SREYA REDDY	Sreya	Sreya
35	19UP1A0478	THAMATAM AKSHITHA	AB	DB
36	19UP1A0479	TURPU SHRAVANI	Shravani	Shravani
37	19UP1A0480	VANGETI BANNY	Banny	Banny
38	19UP1A0481	VENNAMANENI ANOUSHIKA	AB	DB
39	19UP1A0482	YEDULLA NAGALAXMI	Nagalaxmi	Nagalaxmi
40	20UP5A0410	NAGARAM ANUSHA	Anusha	Anusha
41	20UP5A0411	NAKKA YAMINI	AB	DB
42	20UP5A0412	NATTUVA BHARGAVI	Bhargavi	Bhargavi
43	20UP5A0413	PALASA CHANDANA	AB	DB
44	20UP5A0414	SANKURI SRAVANI	Sravani	Sravani
45	20UP5A0415	T ANUSHA	Anusha	Anusha
46	20UP5A0416	VADDABOINA NAMRATHA	AB	DB
47	20UP5A0417	VADLA SHIVANI	Shivani	Shivani
48	20UP5A0418	VINDHYA DARSHINI	Darshini	Darshini
49	20UP5A0419	YAMJALA SHAMILI	Shamili	Shamili

*[Signature]*  
COORDINATOR

*[Signature]*  
ECE, HOD



*[Signature]*  
PRINCIPAL  
Vignana Institute of Management & Technology for Women  
Kondapur(V), Chaitanya(M), Madhavi(Madhapuri)(D)-501301  
Telangana State



DEPARTMENT OF ELECTRONICS AND COMMUNICATION ENGINEERING

Date: 15-11-2021

Conclusion report on "Analog VLSI Chip Design"

**Sub:** conclusion Report of "Analog VLSI Chip Design" conducted on 11<sup>th</sup> & 12<sup>th</sup> November, 2021—reg.

The workshop was aimed to provide knowledge about Analog VLSI Chip Design. Mr. P. Hari Prasad, DEEKSHA TECHNOLOGIES HYD, executed 2-days Workshop on "Analog VLSI Chip Design". After attending this workshop students have expressed about their capability of Designing Analog VLSI Chip and applications in any Electronics Project. This workshop will be helpful for students for circuit development of their final year project. Total 80 students have participated in this workshop. The workshop was an informative and interesting. All the students of ECE had a practical exposure about Analog VLSI Chip Design.

On behalf of the students I request you to arrange more workshops for students to improve the knowledge of students and enhance the career opportunities.

  
Mr. Pullalah Thanam

Associate Professor, ECE.

VMTW, Ghatkesar, HYD.



  
PRINCIPAL  
Vignans Institute of Management & Technology For Women  
Kondapur(V), Ghatkesar(M), Medchal-Malkajgiri(D)-501301  
Telangana State



**VIGNAN'S INSTITUTE OF MANAGEMENT AND TECHNOLOGY FOR WOMEN**

Sponsored by Lavu Educational Society, Approved by AICTE, New Delhi & Affiliated to JNTUH, Hyderabad.  
Kondapur (V), Ghatkesar (M), Medchal - Malkajgiri (D) - 501 301 Phone: +91 96529 10002/3



**DEPARTMENT OF ELECTRONICS AND COMMUNICATION ENGINEERING**

VMTW/ECE/WS/CIR/2019-20/1/1

Date: 07-08-2019

**CIRCULAR**

This is to inform all the IV ECE Students that there will be a Workshop on entitled "LOW POWER CMOS POWER AMPLIFIER" in Association with **Decksha Technologies** by Mr. **P. Hari Prasad** from 13-08-2019 to 14-08-2019 at B-Block Seminar Hall. All students are invited to take part in this Workshop. The participating students will be honored with certificates of participation.

During the Workshop you will be encouraged to interact with the speaker and the other participants through the case study discussions.

HOD

Copy to:

The Principal, for kind information

IQAC

Dept. File

Circular to IV ECE Class Rooms



PRINCIPAL

Vignans Institute of Management & Technology For Women  
Kondapur(V), Ghatkesar(M), Medchal-Malkajgiri(D)-501301  
Telangana State

**Request to conduct a workshop in our college**

Dept. of ECE VMTW <ece@vmtw.in>

To: <hariprasad.peta@gmail.com>

Thu Aug. 1<sup>st</sup>, 2019 at 10:44 AM

Respected sir,

I am Vijaykumar Rewnath Urkude, , HOD , Dept of ECE , Vignan's Institute Of Management And Technology For Women, Ghatkesar, Hyderabad, Telangana. We are planning to conduct a two day workshop on "**Low Power CMOS Power amplifier**" on 13<sup>th</sup> and 14<sup>th</sup> August 2019 to enhance the knowledge of the students. I request to send approval for conducting workshop

Thanking you

Thanks Regards  
Vijaykumar Rewnath Urkude  
Assoc. Prof & HOD,  
Dept. of ECE, VMTW  
Contact: 92937 93986



  
**PRINCIPAL**  
Vignan's Institute of Management & Technology For Women  
Ghatkesar, Hyderabad, Telangana



HariPrasad <hariPrasad.peta@gmail.com>

**Regarding work shop approval**

HariPrasad <hariPrasad.peta@gmail.com>

To: Dept. of ECE VMTW <[ece@vmtw.in](mailto:ece@vmtw.in)>

09, Aug. 2019 at 11:02 AM

Sir/Madam,

Sub: approved for organizing workshop

Hence further enhancement of students knowledge we have approved the organization to conduct a two day workshop on "low Power CMOS Power amplifier".

With Regards,  
Deeksha Technologies,  
9396671541,



  
**PRINCIPAL**  
Sri Yantra Institute of Management & Technology For Women  
Kondapur(V), Ghatkesar(M), Medchal-Malkajgiri(D)-501301  
Telangana State



# REGISTRATION FORM

Resource Person:  
**Mr. P. Hari Prasad,**  
Deeksha Technologies,  
Hyderabad.

Chief-patrons:  
**Dr. L. Rathaiah,**  
Chairman,  
Vignan Group of Institutions.

**Mr. B. Shravan,**  
Chief Executive Officer,  
Vignan Group of Institutions

Patron:  
**Dr. P. Sudhakara Rao,**  
Principal, VMTW

**Mr. Vijaykumar Rewnath Urkude**  
Associate Professor &  
Head of the Department, ECE.

Co-ordinator:  
**Mr. J. Sunil Kumar**  
Assistant Professor,  
Dept. of ECE,  
Contact No: +91 83747 17668

Student Co-ordinator:  
**Ms. T. Anusha**  
Contact No: +91 93473 98739

**Ms. Nattuva Bhargavi**  
Contact No: +91 80965 33999

[www.vmtw.in](http://www.vmtw.in)

 **VIGNAN'S**   
**INSTITUTE OF MANAGEMENT AND  
TECHNOLOGY FOR WOMEN**

(Sponsored by Law Educational Society)  
Approved by AICTE, New Delhi & Affiliated to JNTUH, Hyderabad.  
Kondapur (V), Ghatkesar (M), Medchal - Malkajgiri (D) - 501301

A TWO DAY WORKSHOP ON  
**“LOW POWER CMOS  
POWER AMPLIFIER”**  
13<sup>TH</sup> & 14<sup>TH</sup> AUGUST, 2019

VENUE:  
**‘B’-BLOCK SEMINAR HALL, VMTW**

ORGANIZED BY:  
**DEPARTMENT OF ELECTRONICS AND  
COMMUNICATION ENGINEERING**



Vignan's Institute of Management and Technology for Women (VMTW), is the brainchild of Dr. L. Rathaiiah, Chairman, Vignan Group of Institutions, which was founded August 2008, with four branches of Engineering.

VMTW is an exemplary institution of higher learning with a mission of pursuing excellence in education and research. The institution, with its diverse and dynamic community of about 2000 students offers a distinctive combination of some of the finest facilities for 7 different graduate, and undergraduate programs, accomplished faculty, world-class facilities with a hostel set on a sprawling area of 22 acres sylvan surroundings of mango groves and greenery.

While students at VMTW immerse themselves in academics, the college has a lot in store for them outside the classroom. Student life includes participation in sports, recreational & extra-curricular, and cultural activities. In short, at VMTW students will find an academic and social environment where everyone from faculty members to peers helps shape their future.

VMTW is a home to aesthetically designed buildings with state-of-the-art computer and internet facilities, modern laboratories, workshops, seminar halls, auditoriums, and well-stocked libraries, sports, and games fields.

The Institution boasts of a strong alumni network with alumni events held every year serving as a platform for past students to give back to VMTW and share their experiences with its present fellow students. With so much to offer, it is only natural that students of VMTW get a unique opportunity to carve a niche for themselves in their chosen field of study. It enables them to become well-rounded and discerning professionals, fully qualified for their chosen professions in the workplace. Institute also brings out the creativity in students by imparting engineering knowledge imbuing interpersonal skills to promote innovation, research, and entrepreneurship.

## ABOUT THE DEPARTMENT

Department of Electronics and Communication Engineering was started since the inception of Vignan's Institute of Management and Technology for Women during 2008 with an initial intake of 90. The strength was enhanced to 120 during 2010. The Department had added Post graduate programme in VLSI during the year 2011 and Embedded Systems during 2014 with an intake of 18 each.

The Department has state-of-art laboratories equipped with advanced and well maintained equipment, continuously updated application software packages, more than adequate computing systems with 24x7, 30 MBPS internet facility.

## ABOUT THE COURSE

Designing power amplifiers with low power consumption, high efficiency and integration is an important topic with significant impact on communication and circuit research area.

## COURSE OBJECTIVES

The Internet of Things (IoT) promises the tremendous potential to improve resource management, increase productivity, and enable new business models across business and consumer markets. The basic concept of IoT is to construct an information network architecture that connects many 'things' in the world together.

## EXPECTED OUTCOMES

At the end of Workshop, participants will be able to

- Power analysis of CMOS Power amplifier.
- Gain analysis of CMOS Power amplifier.
- Bandwidth analysis of CMOS Power amplifier.



PRINCIPAL

Vignan's Institute of Management & Technology For Women  
Kandaguri(V), Ghattacheri(M), Medchal-Malkajgiri(DI-501301)  
Telangana State



# VIGNAN'S INSTITUTE OF MANAGEMENT AND TECHNOLOGY FOR WOMEN

Sponsored by Lavu Educational Society, Approved by AICTE, New Delhi & Affiliated to JNTUH, Hyderabad.  
Kondapur (V), Ghatkesar (M), Medchal - Malkajgiri (D) - 501 301 Phone: +91 96529 10002/3



## WORKSHOP ON

# LOW POWER CMOS POWER AMPLIFIER

## 13<sup>TH</sup> & 14<sup>TH</sup> AUGUST, 2019

### DEPARTMENT OF ELECTRONICS AND COMMUNICATION ENGINEERING



*[Signature]*  
PRINCIPAL

Vignan's Institute of Management & Technology For Women  
Kondapur(V), Ghatkesar(M), Medchal - Malkajgiri(D) - 501 301  
Telangana State



# VIGNAN'S INSTITUTE OF MANAGEMENT AND TECHNOLOGY FOR WOMEN

(Sponsored by Lavu Educational Society)  
Approved by AICTE, New Delhi & Affiliated to JNTUH, Hyderabad.

Kondapur (V), Ghatkesar (M), Medchal - Malkajgiri (D) - 501 301



## Certificate of Participation

This certificate is presented to

.....

for her participation in a Two Day Workshop on

"Low Power CMOS Power Amplifier" held from 13-08-2019 to 14-08-2019

Organized by the Department of Electronics and Communication Engineering.

Coordinator



HoD, ECE

PRINCIPAL

Vignan's Institute of Management & Technology For Women  
Kondapur(V), Ghatkesar(M), Medchal-Malkajgiri  
Telangana State

Principal



Vignans Institute Of Management and Technology For Women  
 Work shop on "low Power CMOS Power amplifier"  
 IV B.Tech II sem Students List-2019-20  
 Branch :ECE-A



S. No	Hall Ticket No	Student Name	Sign of the student 13/08/19	Sign of the student 14/08/19
1	16UPIA0401	ALLIAMPALLI RISHITHA	Rishitha	Rishitha
2	16UPIA0402	ANNAPUREDDY DEEPTHI	Deepthi	Deepthi
3	16UPIA0403	APPALAREDDY TEJASHWINI	Tejashwini	Tejashwini
4	16UPIA0404	BAKI SOWMYA	Sowmya	Sowmya
5	16UPIA0405	BALLIKONDA RUTHVIKA	Ruthvi	Ruthvi
6	16UPIA0407	DACHEPALLI NAGA SHARANYA	Sharanya	Sharanya
7	16UPIA0408	DONTHU ALEKHYA	Alekha	Alekha
8	16UPIA0409	DORAM MEGHANA	Meghana	Meghana
9	16UPIA0410	GAJALA SHANTHI SRI	Shanti	Shanti
10	16UPIA0412	GARSHA RAJITHA	Rajitha	Rajitha
11	16UPIA0413	GOURIBATLA SRILEKHA	Srilekha	Srilekha
12	16UPIA0414	GUTHA SUMAREDDY	Suma	Suma
13	16UPIA0415	JAGTAP SRIVIDYA	Srividya	Srividya
14	16UPIA0416	JANUMPALLY SANGEETHA	Sangeetha	Sangeetha
15	16UPIA0417	K NEELA VENKATA SRIYA	Sriya	Sriya
16	16UPIA0418	KAGITHA DURGA VARA PRASANNA SHIVA POOJA	Pooja	Pooja
17	16UPIA0419	KAKI AKANKSHA	Akanksha	Akanksha
18	16UPIA0420	KANUKUNTLA AMULYA	Amulya	Amulya
19	16UPIA0422	KEESARI AKSHITHA	Akshitha	Akshitha
20	16UPIA0423	KOLAGANI KEERTHI	Keerthi	Keerthi
21	16UPIA0424	KONTHAM MANASWINI	Manaswini	Manaswini
22	16UPIA0425	KORATUR YESASVINI RAJA RAJESWARI	Rajeswari	Rajeswari
23	16UPIA0426	KOTI SRI SAI LALITHA SARANYA	Lalitha	Lalitha
24	16UPIA0427	LAKUMARAPU SAI SREEJA	Sreeja	Sreeja
25	16UPIA0428	LINGAPURAM SRAVANI	Sravani	Sravani
26	16UPIA0430	MAHESHWARAM CHANDRIKA	Chandrika	Chandrika
27	16UPIA0431	MALLOJALA PRANAVI	Pranavi	Pranavi
28	16UPIA0432	MARRI RAJESHWARI	Rajeshwari	Rajeshwari
29	16UPIA0434	MUTYALA SINDHUJA	Sindhuja	Sindhuja
30	16UPIA0435	N NISHA REDDY	Nisha	Nisha
31	16UPIA0436	NANDINI KANIKE	Nandini	Nandini
32	16UPIA0437	NERALLAPALLI RAVALIKA	Ravalika	Ravalika
33	16UPIA0438	P NARMADA	Narmada	Narmada
34	16UPIA0439	PELIMELLI HARIKA	Harika	Harika
35	16UPIA0440	PENDYALA SHARANYA	Sharanya	Sharanya
36	16UPIA0441	PIGILAM LIKITHA	Likitha	Likitha
37	16UPIA0442	PULLURI MOUNIKA	Mounika	Mounika
38	16UPIA0443	RAMAGIRI VISHALI LAXMI	Vishali	Vishali
39	16UPIA0445	SAVA SRAVANI	Sravani	Sravani
40	16UPIA0446	SHIKA MANIDEEPA	Manideepa	Manideepa
41	16UPIA0447	UDATA KAVERI KOMRAIYA	Kaveri	Kaveri
42	16UPIA0448	VALISETTY SUSHIMA	Sushima	Sushima



Vignans Institute of Management & Technology (W)  
 Kondapur(V), Ghatkesar(W), Medchal (Rajiv Gandhi)  
 Telangana State

  
CO ORDINATOR

  
HOD, ECE  
Vignee's Institute of Management & Technology For Women  
Kondapur (V), Ghatekonda (M), Madhwal-Atmakur (D) - 501301  
Telangana State





PRINCIPAL  
Vignee's Institute of Management & Technology For Women  
Kondapur (V), Ghatekonda (M), Madhwal-Atmakur (D) - 501301  
Telangana State



Vignans Institute Of Management and Technology For Women  
 Work shop on "low Power CMOS Power amplifier"  
 IV B.Tech II sem Students List-2019-20  
 Branch :ECE-A



S.No	Hall Ticket No	Student Name	Sign of the student 13/08/19	Sign of the student 14/08/19
1	16UP1A0401	ALLIAMPALLI RISHITHA	Rishi	Rishi
2	16UP1A0402	ANNAPUREDDY DEEPTHI	Devi	Devi
3	16UP1A0403	APPALAREDDY TEJASHWINI	Teju	Teju
4	16UP1A0404	BAKI SOWMYA	Sowmya	Sowmya
5	16UP1A0405	BALLIKONDA RUTHVIKA	Ruth	Ruth
6	16UP1A0407	DACHEPALLI NAGA SHARANYA	Shanya	Shanya
7	16UP1A0408	DONTHU ALEKHYA	Alekhya	Alekhya
8	16UP1A0409	DORAM MEGHANA	Megha	Meghana
9	16UP1A0410	GAJALA SHANTHI SRI	Shanthy	Shanthy
10	16UP1A0412	GARSHA RAJITHA	Rajitha	Rajitha
11	16UP1A0413	GOURIBATLA SRILEKHA	Srilekha	Srilekha
12	16UP1A0414	GUTHA SUMAREDDY	Sumareddy	Suma
13	16UP1A0415	JAGTAP SRIVIDYA	Vidya	Vidya
14	16UP1A0416	JANUMPALLY SANGEETHA	Ab	Ab
15	16UP1A0417	K NEELA VENKATA SRIYA	Sriya	Sriya
16	16UP1A0418	KAGITHA DURGA VARA	Vara	Ab
17	16UP1A0419	KAKI AKANKSHA	Akanksha	Akanksha
18	16UP1A0420	KANUKUNTLA AMULYA	Amulya	Ab
19	16UP1A0422	KEESARI AKSHITHA	Akshitha	Akshitha
20	16UP1A0423	KOLAGANI KEERTHI	Keerthi	Keerthi
21	16UP1A0424	KONTHAM MANASWINI	Manu	Manu
22	16UP1A0425	KORATUR YESASVINI RAJA RAJESWARI	Ab	Ab
23	16UP1A0426	KOTI SRI SAI LALITHA SARANYA	Lali	Lali
24	16UP1A0427	LAKUMARAPU SAI SREEJA	Sreeja	Sreeja
25	16UP1A0428	LINGAPURAM SRAVANI	Sravani	Sravani
26	16UP1A0430	MAHESHWARAM CHANDRIKA	Chandrika	Chandrika
27	16UP1A0431	MALLOJALA PRANAVI	Pranavi	Pranavi
28	16UP1A0432	MARRI RAJESHWARI	Rajeshwari	Rajeshwari
29	16UP1A0434	MUTYALA SINDHUJA	Sindhujha	Sindhujha
30	16UP1A0435	N NISHA REDDY	Nisha	Nisha
31	16UP1A0436	NANDINI KANIKE	Nandini	Nandini
32	16UP1A0437	NERALLAPALLI RAVALIKA	Ravaliika	Ravaliika
33	16UP1A0438	P NARMADA	Narma	Narma
34	16UP1A0439	PELIMELLI HARIKA	Harika	Harika
35	16UP1A0440	PENDYALA SHARANYA	Sharanya	Sharanya
36	16UP1A0441	POTIEM LIKITHA	Liki	Liki
37	16UP1A0442	PULLURI MOUNIKA	Mounika	Mounika
38	16UP1A0443	RAMAGIRI VISHALI LAXMI	Laxmi	Laxmi
39	16UP1A0445	SAYA SRAVANI	Sayani	Sayani
40	16UP1A0446	SHIKA MANIDEEPA	Manideepa	Manideepa



PRINCIPAL  
 Vignans Institute of Management and Technology  
 Kondapur(V), Hyderabad, Telangana State

41	I6UP1A0447	UDATA KAVERI KOMRAIYA	Kavay Sushu	Kavai suhu
42	I6UP1A0448	VALISETTY SUSHMA		

  
CO ORDINATOR



  
HOD, ECE  
Head of the Department  
Electronics and Communication Engineering  
Vignani's Institute of Management & Technology  
Kondapur (V), Ghoslaesar (M), Medchal-Mahajir (D)

  
PRINCIPAL

Vignani's Institute of Management & Technology For Women  
Kondapur(V), Ghoslaesar(M), Medchal-Mahajir(D)-501301  
Telangana State





VIGNAN'S INSTITUTE OF MANAGEMENT AND  
TECHNOLOGY FOR WOMEN  
Kondapur (V), Ghatkesar (M), Medchal, Dist – 501 301.



DEPARTMENT OF ELECTRONICS AND COMMUNICATION ENGINEERING

Date: 18-08-2019

Conclusion report on “low Power CMOS Power amplifier”

**Sub:** conclusion Report of “low Power CMOS Power amplifier”

Conducted on 13& 14 August, 19—reg.

The workshop was aimed to provide knowledge about application design using IOT and cloud services.

Mr. P.HariPrasad low Power CMOS Power amplifier, HYD, executed 2-days Workshop on “Application low Power CMOS Power amplifier” and applications workshop. After attending this workshop students have expressed about their capability of Designing Special purpose IOT Devices Design and applications in any Electronics Project. This workshop will be helpful for students for circuit development of their final year project. Total 80 students have participated in this workshop. The workshop was an informative and interesting. All the students of ECE had a practical exposure about IOT Devices Design and its applications.

On behalf of the students I request you to arrange more workshops for students to improve the knowledge of students and enhance the career opportunities

Mr.Sunilkumar .J

Assistant Professor, ECE.

VMTW ,Ghatkesar,HYD.



PRINCIPAL  
Vignan's Institute of Management & Technology For Women  
Kondapur(V),Ghatkesar(M),Medchal-Malkajgiri(Dt)-501301  
Telangana State



VMTW/CSE/CIR/2019-2020/1/04

Date: 27/09/2019

**CIRCULAR**

This is to inform all the students of B.Tech IV year that there will be "A Seminar on Deep Learning Models using Python" on 30/09/2019 by Dr. T. Prabakaran, HOD & Associate Professor, Joginpally BR Engineering College, Hyderabad. The Seminar will be coordinated by Mr V. Nitesh Kumar. All the students are here to attend the Seminar and make it a successful one.

  
PRINCIPAL

PRINCIPAL  
Vignans Institute of Management & Technology For Women  
Kondapur (V), Ghatkesar (M), Medchal-Malkajgiri (Dt)-501301  
Telangana State

Copy to:

1. CEO, for information.
2. All the Deans,
3. The HOD (CSE / ECE / EEE / IT / AIML / BSH)
4. IQAC,
5. Admin Office,
6. All Notice Boards,
7. Circulate to all Class Rooms,
8. File



  
PRINCIPAL

Vignans Institute of Management & Technology For Women  
Kondapur (V), Ghatkesar (M), Medchal-Malkajgiri (Dt)-501301  
Telangana State



# VIGNAN'S INSTITUTE OF MANAGEMENT AND TECHNOLOGY FOR WOMEN

(Sponsored by Lavu Educational Society)

Approved by AICTE, New Delhi & Affiliated to JNTUH, Hyderabad.

Kondapur (V), Ghatkesar (M), Medchal - Malkajgiri (D) - 501 301



## DEPARTMENT OF COMPUTER SCIENCE AND ENGINEERING

ORGANIZING

# A SEMINAR ON DEEP LEARNING MODELS USING PYTHON

30<sup>TH</sup> SEPTEMBER, 2019 @ SEMINAR HALL



Resource Person:

**Dr. T. Prabakaran,**  
Associate Professor & HOD,  
JBR Engineering College,  
Hyderabad

In association with:



**Chief Patron:**  
**Dr. Lavu Rathalah,**  
Chairman, Vignan Group.

**Patron:**  
**Mr. B. Shraavan,**  
CEO, Vignan Group.

**Co-Patron:**  
**Dr. P. Sudhokara Rao,**  
Principal, VMTW.

**Advisor:**  
**Mrs. V. Indrani,**  
Associate Professor & HOD,  
Dept. of CSE

**Co-Ordinator:**  
**Mr. V. N. N. N.**  
Assistant Professor,  
Cell: 93165291000

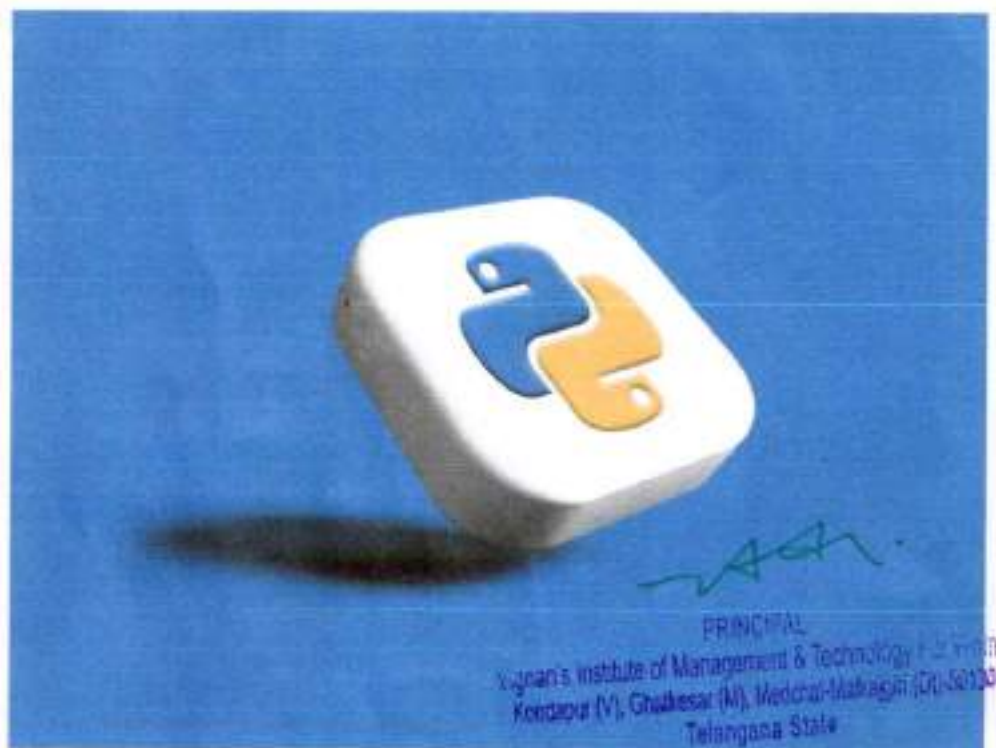

PRINCIPAL  
Vignan's Institute of Management & Technology for Women  
Kondapur (V), Ghatkesar (M), Medchal-Malkajgiri (D) - 501301  
Telangana State



**DEPARTMENT OF COMPUTER SCIENCE AND ENGINEERING**

**Seminar report on "Deep Learning Models using Python"**

Name of the Programme : **Seminar on "Deep Learning Models using Python"**

Organized by: Department of CSE

Schedule dates: 30-09-2019.

Resource Person: **Dr. T.PRABAKARAN, HOD & Associate Professor, Joginpally, BR Engineering College**



**Objective of the Program:** When working with deep learning models using Python, the objectives can vary depending on the specific task or problem you are trying to solve. These objectives provide a broad overview of the tasks and goals involved in working with deep learning models using Python.

**Outcomes of the Seminar:** There are several potential outcomes that are Improved Predictive Performance , Enhanced Accuracy and Generalization,Real-World Applications.These outcomes highlight the potential impact and benefits of using deep learning models in Python, ranging from predictive performance to solving complex real-world problems across diverse domains.

*V. Nijesh*  
**Coordinator**



*[Signature]*  
**PRINCIPAL**  
Vignans Institute of Management & Technology For Women  
Kondapur (V), Ghatkesar (M), Medchal-Malkajgiri (D) - 501 301  
Telangana State

*v. Indira*  
**HOD-CSE**  
Head of The Department  
Computer Science and Engineering  
Vignans Institute of Management & Technology For Women  
Kondapur (V), Ghatkesar (M), Medchal-Malkajgiri (D) - 501 301  
Telangana State



# VIGNAN'S INSTITUTE OF MANAGEMENT AND TECHNOLOGY FOR WOMEN

Sponsored by Lawu Educational Society, Approved by AICTE, New Delhi & Affiliated to JNTUH, Hyderabad.  
Kondapur (V), Ghatkesar (M), Medchal - Malkajgiri (D) - 501 301 Phone: +91 96529 10002/3



## Work Shop On "Deep Learning Models using Python"

### IV-I B.TECH CSE 2019-20

S.NO	ROLL NO	STUDENT NAME	SIGN
1	15UP1A0516	DANTULURI ALEKHYA	Alekhya
2	15UP1A0531	MADHUNAGULA SAHITHI	Sahithi
3	15UP1A0543	S AISHWARYA LAKSHMI	Lakshmi
4	16UP1A0501	ALUGALA SOWMYA	Sowmya
5	16UP1A0502	AMBATI SHIVANI	Shivani
6	16UP1A0503	ANAGANI MEENAKSHI	Meenakshi
7	16UP1A0504	ANNADANAM SAI PUSHYAMI	Pushyami
8	16UP1A0505	BANDAM SRI VARSHINI	Varshini
9	16UP1A0506	BEERELI AKANKSHA	Akanksha
10	16UP1A0507	BHUM SANKEERTHANA	B.Sank
11	16UP1A0508	BODA USHASRI	Usha
12	16UP1A0509	BODDU NEELIMA YADAV	Neelima
13	16UP1A0510	BOPPIDI SINDHUMA	Sindhuma
14	16UP1A0511	BURRI SAI DEEKSHITHA	Deekshitha
15	16UP1A0513	CHALASANI LAKSHMI BHAVANI	Lakshmi
16	16UP1A0514	DEVASANI HARSHITHA	Harshitha
17	16UP1A0515	ERUGU SARITHA	Saritha
18	16UP1A0516	GADDIKOPPULA NAGALAKSHMI	Nagalakshmi
19	16UP1A0518	GANGA NIHARIKA	Niharika
20	16UP1A0519	GANNE SAI BHANU	Sai
21	16UP1A0522	JAJULA JHANSI GOUD	Jhansi
22	16UP1A0523	K KEERTHI REDDY	Keerthi
23	16UP1A0524	K S VIDYA	Vidya
24	16UP1A0525	KAMJULA SRUTHI	Sruthi
25	16UP1A0526	KANDADI SHALINI	Shalini
26	16UP1A0527	KANDULA PAVITRA	Pavitra
27	16UP1A0528	KASPA CHANDRIKA	Chandrika
28	16UP1A0529	KATHULA BHAVANA	Bhavana
29	16UP1A0530	KATTA SRIANUSHA	Srianusha
30	16UP1A0531	KHANDERAO BRUNDA	Brunda
31	16UP1A0533	KODAVALI SAI MANIDEEPA	Manideepa



*(Handwritten signature)*

PRINCIPAL

Vignans Institute of Management & Technology For Women  
Kondapur (V), Ghatkesar (M), Medchal-Malkajgiri (D)-501301  
Telangana State



# VIGNAN'S INSTITUTE OF MANAGEMENT AND TECHNOLOGY FOR WOMEN

Sponsored by Laxmi Educational Society, Approved by AICTE, New Delhi & Affiliated to JNTUH, Hyderabad.  
Kondapur (V), Ghatkesar (M), Medchal - Malkajgiri (D) - 501 301 Phone: +91 96529 10002/3



32	16UP1A0534	KOPPOLU SWETHA	Swetha
33	16UP1A0535	KYATHAM SUJITHA	Sujitha
34	16UP1A0536	MATHANGODU AISWARYA	Aishwarya
35	16UP1A0537	MOLLA SHANTI	Shanti
36	16UP1A0538	NALLAN CHAKRAVARTHULA VINISSRUTA	Vinissruta
37	16UP1A0539	NANNURI UDAYASRI	Udayasri
38	16UP1A0540	NUKA SAISHMA	Saishma
39	16UP1A0541	PASALA SINDHU NIHARIKA	Niharika
40	16UP1A0542	PILLY SUPRIYA	Supriya
41	16UP1A0543	POLAVENI MEGHASWI	Meghaswi
42	16UP1A0544	RAVULA MOUNIKA	Mounika
43	16UP1A0545	SAGARLA MAHESHWARI	Maheshwari
44	16UP1A0546	SAMINENI SREE LAKSHMI	Lakshmi
45	16UP1A0547	SRIRAMOJU SWATHI	Swathi
46	16UP1A0548	SURAKANTI SIRISHA	Sirisha
47	16UP1A0549	THOUTI SAMANA	Samana
48	16UP1A0550	UNDADI SRUJANA BHARATHI	Srujana
49	16UP1A0551	UYYALA TEJASWINI	Tejaswini
50	16UP1A0552	VAKITI SAI SINDHU	Sindhu
51	16UP1A0554	VUPPALA SAHITHI	Sahithi
52	16UP1A0555	YALAGALA SAHITHI	Sahithi
53	16UP1A0556	YANNU AKHILA	Akhila



  
PRINCIPAL

Vignans Institute of Management & Technology For Women  
Kondapur (V), Ghatkesar (M), Medchal-Malkajgiri (D)-501301  
Telangana State



# VIGNAN'S INSTITUTE OF MANAGEMENT AND TECHNOLOGY FOR WOMEN

(Sponsored by Lavu Educational Society)

Approved by AICTE, New Delhi & Affiliated to JNTUH, Hyderabad.

**Kondapur (V), Ghatkesar (M), Medchal - Malkajgiri (D) - 501 301**

Accredited By



In association with:



## CERTIFICATE OF PARTICIPATION

This certificate is presented to Ms. ....PILLY SUPRIYA.....  
for her participation in a seminar on “**Deep Learning Models Using Python**” held on **30th September, 2019**, Organized by the Department of Computer Science and Engineering, in association with Joginpally BR Engineering College, Hyderabad.



*[Signature]*  
PRINCIPAL  
Vignans Institute of Management & Technology For Women  
Kondapur (V), Ghatkesar (M), Medchal-Malkajgiri (D) 501301  
Telangana State

*[Signature]*  
Co-Ordinator

*[Signature]*  
HoD, CSE

*[Signature]*  
Principal



# Industrial Visit Collaborated with Sri Gajanan E-Slates Pvt.Ltd



PRINCIPAL

Vignans Institute of Management & Technology For Women  
Kondapur (V), Ghatkesar (M), Medchal-Malkajgiri (D),-501304  
Telangana State





# VIGNAN'S INSTITUTE OF MANAGEMENT AND TECHNOLOGY FOR WOMEN

(Sponsored by Lavu Educational Society)

[Affiliated to JNTUH, Hyderabad & Approved by AICTE, New Delhi]

Kondapur (V), Ghatkesar (M), Medchal-Malkajgiri (D) - 501 301. Phone: 96529 10002/3

Department of Computer Science and Engineering



# VIGNAN'S INSTITUTE OF MANAGEMENT AND TECHNOLOGY FOR WOMEN

(Sponsored by Lavu Educational Society)

[Approved by AICTE, New Delhi & affiliated to JNTU, HYDERABAD]

To  
Dr. Dinesh Srivastava  
Chairman & Chief Executive  
Nuclear Fuel Complex  
ECIL Post, Moula - Ali,  
Hyderabad - 500 062

06-09-2018

Sub: Permission for an Industrial Visit - Reg.

Dear Sir,

We are one of the 8 well reputed engineering institutions under Vignans Group of Institutions, situated in Kondapur about 15kms from city of Hyderabad. We are always ranked within first 10 ranks in JNTU(H). We have B.Tech. and M.Tech. courses in many branches of engineering, including Electronics and Communication Engineering and Computer Science Engineering. We would like our students to get exposed to Industrial environment and more importantly industry practices, which would help them, upon their entry into any industry, to get set in the industry environment faster and deliver their jobs efficiently.

We wish to organize an Industrial visit to NFC, for about 120 students in sequential slots, on your convenient dates, during the 3<sup>rd</sup> week of September, 2018. We understand that NFC is on the forefront to nurture the students of the nation and would play a vital role in contributing to their knowledge. We wish to get an opportunity for our Women engineers to visit your organization and understand real-time entrepreneurial activities. We wish to arrange this visit for our III B.Tech., CSE students.

We assure you that we would not disturb your regular work / production and conduct our students with utmost discipline. We anticipate a positive response for the visit.

Thanking You,



Yours Sincerely

*[Signature]*  
[DR. P. SUDHAKARA RAO]

Principal  
PRINCIPAL

Kondapur Village, Ghatkesar Mandal, Medchal Dist. - 501 301  
E-mail: hyd.vmtw.pri@vignans.edu.in, info.vmtw@gmail.com



Vignans Institute of Management & Technology For Women  
Kondapur(V), Ghatkesar(M), Medchal-Malkajgiri(D)-501301  
Telangana State



# VIGNAN'S INSTITUTE OF MANAGEMENT AND TECHNOLOGY FOR WOMEN

(Sponsored by Lavu Educational Society)

[Affiliated to JNTUH, Hyderabad & Approved by AICTE, New Delhi]

Kondapur (V), Ghatkesar (M), Medchal-Malkajgiri (D) - 501 301. Phone: 96529 10002/3

Department of Computer Science and Engineering

Date: 01/10/2018

Sub :- Request seeking permission to Industrial Visit-NFC - reg

It is proposed to Industrial Visit-NFC 04.10.2018 & 10.10.2018 for the III B.Tech CSE students. The details of schedule and budget are mentioned in Table I & Table 2 respectively.

A total of 115 students are participating in this seminar as it is useful for the students in the current semester.

S. No.	Days	Schedule	Faculty Members	Designation
	2	04.10.2018 and 10.10.2018	Mr.V. Nitesh Mr.P.Vinay Kumar Mrs. D. Deepthi Sri	Asst. Professor, VMTW

Table 1: Details of schedule

S. No.	Expenditure	
1	Buses	3000
2	Food Expenditure	10000
3	Drivers allowances	1000
4	Others	2000
5	Total Expenditure	16000

Table 2: Details of Expenditure

We request you to give permission for conducting this Industrial Visit and sanction the Amount of R 16000/.

Submitted for Approval  
HOD CSE  
Department of Computer Science and Engineering  
Vignans Institute of Management & Technology For Women  
Kondapur (V), Ghatkesar (M), Medchal-Malkajgiri (D) - 501 301, T.S.



*[Signature]*  
PRINCIPAL

*[Signature]*  
PRINCIPAL  
Vignans Institute of Management & Technology For Women  
Kondapur (V), Ghatkesar (M), Medchal-Malkajgiri (D) - 501 301  
Telangana State



# VIGNAN'S INSTITUTE OF MANAGEMENT AND TECHNOLOGY FOR WOMEN

(Sponsored by Lavu Educational Society)

[Affiliated to JNTUH, Hyderabad & Approved by AICTE, New Delhi]

Kondapur (V), Ghatkesar (M), Medchal-Malkajgiri (D) - 501 301. Phone: 96529 10002/3

Department of Computer Science and Engineering

VMTW/BS&H-IV/2019-20/SEM-I/Cir-01

Date: 03.10.2018

## CIRCULAR

This is to inform all the HOD's, staff and students that there will be an Industrial Visit for all CSE&ECE students on 04.10.2018 & 10.10.2018 at NFC. The Industrial Visit co-ordinate by Mr.K.Santhosh Kumar, Asst.Prof, Mr.K.Bal Reddy, Asst. Prof and. All the students are hereby informed to assemble in college campus by 8.00 am and to attend the NFC and make it a successful one.

*Handwritten signature*  
The HOD in Charge  
Department of Computer Science and Engineering  
Vignans Institute of Management & Technology for Women  
Kondapur (V), Ghatkesar (M), Medchal-Malkajgiri (D) - 501 301, Telangana State



*Handwritten signature*  
PRINCIPAL  
Vignans Institute of Management & Technology for Women  
Kondapur (V), Ghatkesar (M), Medchal-Malkajgiri (D) - 501 301,  
Telangana State



# VIGNAN'S INSTITUTE OF MANAGEMENT AND TECHNOLOGY FOR WOMEN

(Sponsored by Lawu Educational Society)

[Affiliated to JNTUH, Hyderabad & Approved by AICTE, New Delhi]

Kondapur (V), Ghatkesar (M), Medchal-Malkajgiri (D) - 501 301. Phone: 96529 10002/3

Department of Computer Science and Engineering

Date: 04.10.2018

## NOTE

Sub: Report of "Industrial Visit-NFC" on on 04.10.2018 -Reg.

A One day Industrial Visithas been coordinate by **Mr.V.Netesh, Asst.Prof , Mr.P.Vinay Bhushan, Asst. Prof** and **Mrs. D. Deepthi Sri, Asst. Prof** at NFC , in order to increase the awareness among the students.

The Industrial Visit was an informative and interesting. All the students of CSE had knowledge in Empower NFC Technology to convey a reliably sure client experience Encourage the NFC Forum biological systemto embrace a visual identifier that advises students should tap for activity Educate endeavors, specialist co-ops, and designers on the best way to utilize NFC innovation to convey significant arrangements and develop their organizations Continue to create particulars, test instruments, and rules that guarantee predictable, secure, and interoperable use cases around the world.

After attending this Industrial Visit -NFC Students have expressed about their capability in usage of empower organizations to deliver secure, tap-based interactions with an intuitive, reliable experience to users around the globe.. On behalf of the students I request you to arrange more Industrial Visit for students to improve the knowledge of students and enhance the career opportunities.

  
Mrs. V.Nitesh

Asst. Professor (CSE)



  
**PRINCIPAL**  
Vignan's Institute of Management & Technology For Women  
Kondapur(V),Ghatkesar(M),Medchal-Malkajgiri(D)-501301  
Telangana State



# VIGNAN'S INSTITUTE OF MANAGEMENT AND TECHNOLOGY FOR WOMEN

Sponsored by Lavu Educational Society, Approved by AICTE, New Delhi & Affiliated to JNTU, Hyderabad.  
Kondapur (V), Ghatekwar (M), Medchal - Malkajgiri (D) - 501 301 TS INDIA  
Phone: +08815 200005/07/08 Email: info@vmtw.in



*[Signature]*  
**PRINCIPAL**  
Vignans Institute of Management & Technology for Women  
Kondapur (V), Ghatekwar (M), Medchal - Malkajgiri (D), 501 301  
Telangana State



# VIGNAN'S INSTITUTE OF MANAGEMENT AND TECHNOLOGY FOR WOMEN

Sponsored by Laxmi Educational Society, Approved by AICTE, New Delhi & Affiliated to JNTUH, Hyderabad.  
Kondapur (V), Ghatkesar (M), Medchal - Malkajgiri (D) - 501 301 TS INDIA  
Phone: +08615 200006/07/08 Email: info@vmtw.in



*WASH*  
PRINCIPAL  
Vignan's Institute of Management & Technology for Women  
Kondapur (V), Ghatkesar (M), Medchal - Malkajgiri (D), 501301  
Telangana State



# VIGNAN'S INSTITUTE OF MANAGEMENT AND TECHNOLOGY FOR WOMEN

(Sponsored by Lawu Educational Society)

[Affiliated to JNTUH, Hyderabad & Approved by AICTE, New Delhi]

Kondapur (V), Ghatkesar (M), Medchal-Malkajgiri (D) - 501 301. Phone: 96529 10002/3

Department of Computer Science And Engineering

## LIST OF STUDENTS CSE-A

S.No.	Hall Ticket No	Name of Students
1	15UP1A0516	DANTULURI ALEKHYA
2	15UP1A0531	MADHUNAGULA SAHITHI
3	15UP1A0543	S AISHWARYA LAKSHMI
4	16UP1A0501	ALUGALA SOWMYA
5	16UP1A0502	AMBATI SHIVANI
6	16UP1A0503	ANAGANI MEENAKSHI
7	16UP1A0504	ANNADANAM SAI PUSHYAMI
8	16UP1A0505	BANDAM SRI VARSHINI
9	16UP1A0506	BEERELI AKANKSHA
10	16UP1A0507	BHUM SANKEERTHANA
11	16UP1A0508	BODA USHASRI
12	16UP1A0509	BODDU NEELIMA YADAV
13	16UP1A0510	BOPPIDI SINDHUMA
14	16UP1A0511	BURRI SAI DEEKSHITHA
15	16UP1A0513	CHALASANI LAKSHMI BHAVANI
16	16UP1A0514	DEVASANI HARSHITHA
17	16UP1A0515	ERUGU SARITHA
18	16UP1A0516	GADDIKOPPU NAGALAKSHMI
19	16UP1A0518	GANGA NIHARIKA
20	16UP1A0519	GANNE SAI BHANU
21	16UP1A0522	IAJULA JHANSI GOUD
22	16UP1A0523	K KEERTHI REDDY
23	16UP1A0524	K S VIDYA
24	16UP1A0525	KAMJULA SRUTHI
25	16UP1A0526	KANDADI SHALINI
26	16UP1A0527	KANDULA PAVITRA
27	16UP1A0528	KASPA CHANDRIKA
28	16UP1A0529	KATHULA BHAVANA
29	16UP1A0530	KARLA SRIANUSHA
30	16UP1A0531	KANDERAO BRUNDA



**PRINCIPAL**  
Vignan's Institute of Management & Technology for Women  
Kondapur(V), Ghatkesar(M), Medchal-Malkajgiri(D)-501301  
Telangana State



# VIGNAN'S INSTITUTE OF MANAGEMENT AND TECHNOLOGY FOR WOMEN

[Sponsored by Lavu Educational Society]

[Affiliated to JNTUH, Hyderabad & Approved by AICTE, New Delhi]

Kondapur (V), Ghatkesar (M), Medchal-Malkajgiri (D) - 501 301. Phone: 96529 10002/3

Department of Computer Science And Engineering

31	16UP1A0533	KODAVALI SAI MANIDEEPA
32	16UP1A0534	KOPPOLU SWETHA
33	16UP1A0535	KYATHAM SUJITHA
34	16UP1A0536	MATHANGODU AISWARYA
35	16UP1A0537	MOLLA SHANTI
36	16UP1A0538	NALLAN CHAKRAVARTHULA VINISSRUTA
37	16UP1A0539	NANNURI UDAYASRI
38	16UP1A0540	NUKA SAISHMA
39	16UP1A0541	PASALA SINDHU NIHARIKA
40	16UP1A0542	PILLY SUPRIYA
41	16UP1A0543	POLAVENI MEGHASWI
42	16UP1A0544	RAVULA MOUNIKA
43	16UP1A0545	SAGARLA MAHESHWARI
44	16UP1A0546	SAMINENI SREE LAKSHMI
45	16UP1A0547	SRIRAMOJU SWATHI
46	16UP1A0548	SURAKANTI SIRISHA
47	16UP1A0549	THOUTI SAMANA
48	16UP1A0550	UNDADI SRUJANA BHARATHI
49	16UP1A0551	UYYALA TEJASWINI
50	16UP1A0552	VAKITI SAI SINDHU
51	16UP1A0554	VUPPALA SAHITHI
52	16UP1A0555	YALAGALA SAHITHI
53	16UP1A0556	YANNU AKHILA
54	16UP1A0557	A SAI SREE
55	16UP1A0558	A.SAI SRILEKHA
56	16UP1A0559	AKOJU HARIKA
57	16UP1A0560	BALNI RAKSHANA ANGEL REDDY
58	16UP1A0561	BANOTH VASAVI



*24/11*  
PRINCIPAL  
Vignan's Institute of Management & Technology for Women  
Kondapur(V), Ghatkesar(M), Medchal-Malkajgiri(D)-501301  
Telangana State



FEEDBACK FORM FOR INDUSTRIAL VISIT

Event: NFC (INDUSTRIAL VISIT)

Date: 10/10/18

Presenter(s): PALABATLA SHIVANI

Please respond to the following statements by using the 4-point rating scale to indicate the extent to which you agree or disagree with each statement.

4- Strongly Agree      3- Agree      2- Disagree      1- Strongly Disagree or fill the Cell

1	In this a first time or return visit?	4
2	Was the length and content of your tour age appropriate?	4
3	What was the Best part of Your tour or visit?	4
4	What was least part of tour or visit?	3
5	Is there anything you wanted to see that was not exhibited?	4
6	What do you feel should we added to the visit to improve it?	4
7	Any Suggestions	4

FEEDBACK FORM FOR INDUSTRIAL VISIT

Event: NFC (Industrial visit)

Date: 10/10/18

Presenter(s): A. SAI SREE

Please respond to the following statements by using the 4-point rating scale to indicate the extent to which you agree or disagree with each statement.

4- Strongly Agree      3- Agree      2- Disagree      1- Strongly Disagree or fill the Cell

1	In this a first time or return visit?	4
2	Was the length and content of your tour age appropriate?	4
3	What was the Best part of Your tour or visit?	4
4	What was least part of tour or visit?	4
5	Is there anything you wanted to see that was not exhibited?	4
6	What do you feel should we added to the visit to improve it ?	3
7	Any Suggestions	4



PRINCIPAL  
Vignee's Institute of Management & Technology For Women  
Kondapur(V), Ghatkesar(M), Medchal-Malkajgiri(Dt)-501301  
Telangana State

FEEDBACK FORM FOR INDUSTRIAL VISIT

Event: *WFC (Industrial visit)*

Date: *04/10/18*

Presenter(s): *Beevareti Akanksha*

Please respond to the following statements by using the 4-point rating scale to indicate the extent to which you agree or disagree with each statement.

4- Strongly Agree      3- Agree      2- Disagree      1- Strongly Disagree or fill the Cell

1	In this a first time or return visit?	<i>4</i>
2	Was the length and content of your tour age appropriate?	<i>3</i>
3	What was the Best part of Your tour or visit?	<i>2</i>
4	What was least part of tour or visit?	<i>3</i>
5	Is there anything you wanted to see that was not exhibited?	<i>4</i>
6	What do you feel should we added to the visit to improve it?	<i>2</i>
7	Any Suggestions	

FEEDBACK FORM FOR INDUSTRIAL VISIT

Event: *WFC (Industrial visit)*

Date: *04/10/18*

Presenter(s): *Devasani Harshitha*

Please respond to the following statements by using the 4-point rating scale to indicate the extent to which you agree or disagree with each statement.

4- Strongly Agree      3- Agree      2- Disagree      1- Strongly Disagree or fill the Cell

1	In this a first time or return visit?	<i>4</i>
2	Was the length and content of your tour age appropriate?	<i>3</i>
3	What was the Best part of Your tour or visit?	<i>2</i>
4	What was least part of tour or visit?	<i>3</i>
5	Is there anything you wanted to see that was not exhibited?	<i>4</i>
6	What do you feel should we added to the visit to improve it ?	<i>2</i>
7	Any Suggestions	



*WASH*  
PRINCIPAL  
Vignana's Institute of Management & Technology for Women  
Kondapur(V), Ghatkesar(M), Medchal-Malkajgiri(Dt)-501301  
Telangana State



# VIGNAN'S INSTITUTE OF MANAGEMENT AND TECHNOLOGY FOR WOMEN

Sponsored by Levis Educational Society, Approved by AICTE, New Delhi & Affiliated to INTUW, Hyderabad.  
Kondapur (V), Ghatkesar (M), Medchal-Malkajgiri (Dt) - 501 301 TS INDIA  
Phone: +08615 200006/07/08 Email: info@vmtw.in

Date: 18-01-2019

VMTW/ TP/CSE//CIR / 2018-19/ 03

## CIRCULAR

All the HODs and Placement Coordinators are hereby requested to inform IV- B.Tech students that "**Campus Recruitment Training by CoCubes**" will be conducted in our college starting from 22-01-2019 to 25-01-2019.

Contact T&P Cell for further information.

Copy to:

1. CEO for information,
2. All the Deans,
3. The HOD (CSE / ECE / EEE / IT / AIML / BSH),
4. IQAC,
5. Admin Office,
6. All Notice Boards,
7. Circulate to all Class Rooms,
8. File.



  
**PRINCIPAL**  
Vignan's Institute of Management & Technology For Women  
Kondapur (V), Ghatkesar (M), Medchal-Malkajgiri (Dt.)-5  
Telangana State

  
**PRINCIPAL**  
Vignan's Institute of Management & Technology For Women  
Kondapur (V), Ghatkesar (M), Medchal-Malkajgiri (Dt.)-501301  
Telangana State



Date: 27-01-2019

## Training placement cell

### Report on CRT Program Conducted by Co-Cubes

**Name of the Program:** Campus Recruitment Training

**Syllabus:** Coding and decoding, group discussion, interview skills, resume writing Quantitative aptitude, number system, logical reasoning, verbal aptitude. Reading comprehension, computer fundamentals, and email and telephone etiquette.

**Objective:** To train the students in areas such as quantitative aptitude, verbal aptitude, reading comprehension, fundamentals of programming and soft skills to make them ready for placements.

**Name of the Organization:** Co-Cubes

**Dates of the program:** 22-01-2019 to 25-01-2019

**Number of students attended:** 93



**Outcome:** Students were trained in quantitative aptitude, logical reasoning, verbal aptitude, reading comprehension, soft skills, group discussions, interview skills.

The undersigned thanked the respective department coordinators and CoCubes, for their able support in completing the program successfully.



*[Handwritten Signature]*  
**PRINCIPAL**  
Vignans Institute of Management & Technology For Women  
Kondapur (V), Medchal - Malkajgiri (D) - 501301  
T.S.

CRT Program Conducted by CoCubes  
CSE Attendance

S.NO	Roll no	Student Name	22/01	23/01	24/01	25/01
1	14UPIA0505	B.Meghana	P	AB	P	P
2	15UPIA0501	ANNAVARAPU HIMA RAJYALAKSHMI	P	AB	P	P
3	15UPIA0502	BASUDE PREETHI	P	P	AB	P
4	15UPIA0503	BAYYADUGULA PRAVEENA	P	P	P	P
5	15UPIA0504	BEENAMOHINA TEJASVEE YADAV	P	AB	P	P
6	15UPIA0505	BODIKA SANDHYA RANI	P	P	P	P
7	15UPIA0506	BOLLOJU RAMYA SMRUTHI	P	AB	P	P
8	15UPIA0507	BOMMA AKHILA	P	P	AB	P
9	15UPIA0508	BONTHU TARUNA SRI	P	P	P	P
10	15UPIA0509	BURUGU TEJASRI	AB	AB	P	P
11	15UPIA0510	CHENNALA GAYATRI YADAV	P	P	AB	AB
12	15UPIA0511	CHINDAM PRANAVA	P	P	P	P
13	15UPIA0512	CHOWDARAPU SRIJA	AB	P	P	P
14	15UPIA0513	D A DIVYA	P	P	P	P
15	15UPIA0514	D ANUSHA	P	P	P	P
16	15UPIA0515	DAMULURI DIVYA	AB	P	P	P
17	15UPIA0517	DENDUKURU SRIREKHA	P	AB	P	P
18	15UPIA0518	DHARNI MANISHA	P	P	P	P
19	15UPIA0519	G VAISHNAVI	P	P	P	P
20	15UPIA0520	GOLEM SUPRAJA CHINMAYEE	P	P	P	P
21	15UPIA0522	GULLIPALLI JAHNAVI	P	P	P	P
22	15UPIA0523	GUNDA SOWMYA	P	P	P	P
23	15UPIA0524	GURDEEP KAUR JANDU	P	P	AB	P
24	15UPIA0525	K ANUSHA	P	P	AB	AB
25	15UPIA0526	K SHRUTHI	P	P	P	P
26	15UPIA0528	KAMBALAPALLY MOUNIKA	P	AB	P	P
27	15UPIA0529	KOTIKA SIVA PARVATHI	P	P	P	P
28	15UPIA0530	KRISHNADHARI SOWJANYA	P	AB	P	P
29	15UPIA0532	MANJULA DIGAMBER DEVKATTE	P	P	P	AB
30	15UPIA0533	MARPU SWETHA REDDY	AB	AB	P	P
31	15UPIA0534	MOGULURU VENKATA NAGASWETHA	P	P	P	P
32	15UPIA0535	N NIHARIKA REDDY	P	P	P	AB
33	15UPIA0536	NAKREKANTI PRASHANTHI	P	P	P	P
34	15UPIA0537	NERELLA TEJASWINI	P	AB	P	P
35	15UPIA0538	PADMAM KRISHNAVENI	P	P	AB	P
36	15UPIA0539	PANAGANTI MADHUSHALINI	P	P	P	P
37	15UPIA0540	POTHAM JYOSHNA DEVI	P	P	P	AB
38	15UPIA0541	PULAMONI PRAVALIKA	P	P	AB	P
39	15UPIA0542	PULGAM KAVYA	P	P	P	P
40	15UPIA0543	PURKAYASTHA RIKONDA POOJA	AB	AB	AB	P



PRINCIPAL  
Vignaa's Institute of Management & Technology For Women  
Kondapur(V), Ghatkesar(M), Medchal-Malkajgiri(DI)-501301  
Telangana State

41	15UPIA0545	SRAVANI REDDY BARLAPALLY	P	P	P	AB
42	15UPIA0546	SRI RAMA VINEETHA	P	P	AB	AB
43	15UPIA0547	SUNKARA SAIMOUNIKA	P	P	AB	P
44	15UPIA0549	SWARGAM MOUNIKA	AB	P	AB	P
45	15UPIA0550	THOUTAM CHANDANA	P	P	AB	P
46	15UPIA0551	VALABOJU DIVYA SRI	P	P	P	P
47	15UPIA0552	AKULA VANAJA	P	P	P	P
48	15UPIA0553	AKUULA PRIYANKKA	P	P	P	P
49	15UPIA0554	ANANTHULA RAVALI	P	P	AB	P
50	15UPIA0555	ANDAM SIRISHA	P	P	P	P
51	15UPIA0556	BANDI RASHMITHA	P	P	P	P
52	15UPIA0557	BAREDDY SRAVANTHI	P	P	P	P
53	15UPIA0559	BOPPIDI ROOPASRI	P	P	P	P
54	15UPIA0560	CHANDA VARALAXMI	AB	P	P	P
55	15UPIA0562	CHIRABOINA RAMADEVI	P	P	P	P
56	15UPIA0563	CHOWDAVARAPU LAKSHMI PRIYA	P	P	AB	P
57	15UPIA0564	DARIPALLI AMANI	P	P	P	P
58	15UPIA0565	EDUKULLA LIKITHA	P	P	P	P
59	15UPIA0567	GOPISHETTY SAHAJA	P	P	P	P
60	15UPIA0568	K NAVA JYOTHI	P	P	P	P
61	15UPIA0569	KANDULA MANMITHA	AB	P	P	P
62	15UPIA0570	KARLA AMULYA	P	P	P	AB
63	15UPIA0571	L SONALI	P	P	P	P
64	15UPIA0572	MANDADI MOUNIKA	P	P	P	P
65	15UPIA0573	MARYALA DIKSHITHA	AB	P	P	P
66	15UPIA0574	MENDE KAVYA	P	AB	AB	P
67	15UPIA0575	MIRYALA SRI LAKSHMI	P	P	P	P
68	15UPIA0576	MOOLA VIDYA SRI	P	P	P	AB
69	15UPIA0577	N USHARANI	AB	P	P	P
70	15UPIA0578	NANDINI BANDARU	P	P	AB	P
71	15UPIA0579	NANGUNURI NAVYA SRI	P	AB	P	P
72	15UPIA0580	PENDYALA LASYA PRIYA	P	P	AB	P
73	15UPIA0581	PININTI NIHARIKA REDDY	P	P	P	P
74	15UPIA0582	PUTTA DEEKSHITHA	AB	AB	P	AB
75	15UPIA0583	RAMADEVI SEELAM	P	P	P	AB
76	15UPIA0584	RAVALKOLE MANASA	P	P	P	P
77	15UPIA0585	RAVIRALA HARSHITHA	P	AB	P	P
78	15UPIA0586	RELANGI VIJAYA DURGA	P	P	P	P
79	15UPIA0587	SAGIREDDY HEVANYA	P	P	AB	AB
80	15UPIA0588	SAMALA ANUSHA	AB	P	AB	P
81	15UPIA0589	SANTHAPURI VAISHNAVI	P	P	P	P
82	15UPIA0590	SOMA SHRUTHI	AB	AB	P	AB



*Handwritten signature*  
PRINCIPAL

Vignans Institute of Management & Technology For Women  
Kondapur(V), Ghatkesar(M), Medchal-Malkajgiri(DI)-501301  
Telangana State

83	15UP1A0591	SUMREDDY ABHINAYA	AB	AB	P	AB
84	15UP1A0592	SUNKARI SOWMYA REDDY	P	P	AB	P
85	15UP1A0593	TALAPAREDDY SANGHAVI	AB	P	P	P
86	15UP1A0594	THIRMANI BHAVANI	P	AB	P	P
87	15UP1A0595	VEERANALA MANASA	P	P	AB	P
88	15UP1A0596	VELAPATI SOWMYA	AB	P	P	P
89	15UP1A0598	VEMI REDDY LAKSHMI KALYANI	P	P	P	P
90	15UP1A0599	VODDE DIVYA	AB	P	P	P
91	15UP1A05A1	VOOTUKURY PRAVALLIKA	AB	P	P	P
92	15UP1A05A2	VORUGANTI PRAVALLIKA	P	AB	P	P
93	15UP1A05A3	MAHVEEN ARSHI	P	P	AB	AB



*ASH*  
**PRINCIPAL**  
 Vignaa's Institute of Management & Technology For Women,  
 Kondapur(V), Ghatkesar(M), Medchal-Malkajgiri(Dt)-501301,  
 Telangana State



VMTW/CSE/CIR/2018-2019/II/06

Date:25/03/2019

**CIRCULAR**

This is to inform all the students of B.Tech IV year that there will be "A Seminar on Neural Networks and Deep Learning" on 28/03/2019 by M.V.Punnam, Manager, TagIT Consulting, Hyderabad. The Seminar will be coordinated by Mr.K.Bharath Reddy. All the students are here to attend the Seminar and make it a successful one.

  
PRINCIPAL  
PRINCIPAL

Vignan's Institute of Management & Technology For Women  
Kondapur (V), Ghatkesar (M), Medchal-Malkajgiri (D)-501 301  
Telangana State

Copy to:

1. CEO, for information.
2. All the Deans,
3. The HOD (CSE / ECE / EEE / IT / AIML / BSH)
4. IQAC,
5. Admin Office,
6. All Notice Boards,
7. Circulate to all Class Rooms,
8. File



  
PRINCIPAL  
Vignan's Institute of Management & Technology For Women  
Kondapur (V), Ghatkesar (M), Medchal-Malkajgiri (D)-501 301  
Telangana State





# VIGNAN'S INSTITUTE OF MANAGEMENT AND TECHNOLOGY FOR WOMEN

(Approved by AICTE, New Delhi & Affiliated to JNTUH, Hyderabad.)

Kondapur (V), Ghatkesar (M), Medchal - Malkajgiri (D) - 501 301

DEPARTMENT OF COMPUTER SCIENCE AND ENGINEERING

ORGANIZING

A SEMINAR ON

# NEURAL NETWORKS AND DEEP LEARNING

28<sup>TH</sup> MARCH, 2019 @ SEMINAR HALL

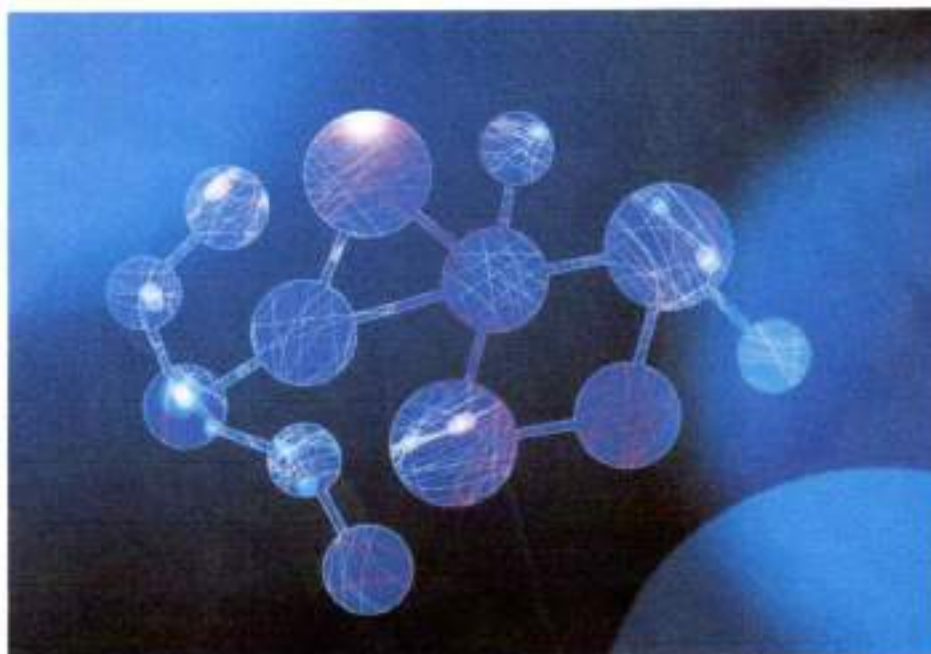

Chief Patron:  
**Dr. Lavu Rathaiah,**  
Chairman, Vignan Group.

Patron:  
**Mr. B. Shrvan,**  
CEO, Vignan Group.

Co-Patron:  
**Dr. P. Sudhakara Rao,**  
Principal, VMTW.

Advisor:  
**Mrs. V. Indrani,**  
Associate Professor & HOD,  
Dept. of CSE.

Co-Ordinator:  
**Mr. K. Bharath Reddy,**  
Assistant Professor, CSE.

Cell: +91 96529 10002

PRINCIPAL

Vignan's Institute of Management & Technology For Women  
in association with





# VIGNAN'S INSTITUTE OF MANAGEMENT AND TECHNOLOGY FOR WOMEN

Sponsored by Luvu Educational Society, Approved by AICTE, New Delhi & Affiliated to JNTUH, Hyderabad, Kondapur (V), Ghatkesar (M), Medchal - Malkajgiri (D) - 501 301 Phone: +91 96529 10002/3



## DEPARTMENT OF COMPUTER SCIENCE AND ENGINEERING

### **Seminar report on “ Neural Networks and Deep Learning “**

Name of the Programme : Seminar on Neural Networks and Deep Learning

Organized by: Department of CSE

Schedule dates: 28-03-2019.

Resource Person: M.V.Punnam, Manager, TagIT Consulting.



**Objective of the Program:** The objectives of neural networks and deep learning are to develop and train artificial neural networks to perform complex tasks by learning from data.

**Outcomes of the Seminar:** Neural networks and deep learning have had a significant impact on various fields and have led to several notable outcomes. Image Recognition and Computer Vision, Natural Language Processing (NLP), Speech Recognition, Healthcare and Biomedicine. These outcomes highlight the wide-ranging impact of neural networks and deep learning, transforming industries, and driving innovations in various domains.

*K. Bharath*  
**Coordinator**



*Adh*  
**PRINCIPAL**  
Vignan's Institute of Management & Technology For Women  
Kondapur (V), Ghatkesar (M), Medchal-Malkajgiri (D)-501301  
Telangana State

*V. Indira*  
**HOD-CSE**

Head of The Department  
Computer Science and Engineering  
Vignan's Institute of Management & Technology For Women  
Kondapur (V), Ghatkesar (M), Medchal-Malkajgiri (D)-501301  
Telangana State



# VIGNAN'S INSTITUTE OF MANAGEMENT AND TECHNOLOGY FOR WOMEN

Sponsored by Lawu Educational Society, Approved by AICTE, New Delhi & Affiliated to JNTUH, Hyderabad.  
Kondapur (V), Ghatkesar (M), Medchal - Malkajgiri (D) - 501 301 Phone: +91 96529 10002/3



## Work Shop On Neural Network And Deep Learning

### IV-II B.TECH ROLL LST-2018-19 CSE

S.NO	ROLL NO	STUDENT NAME	SIGN
1	14UP1A0505	B.MEGHANA	Meghana
2	15UP1A0501	ANNAVARAPU HIMA RAJYALAKSHMI	Rajyalakshmi
3	15UP1A0502	BASUDE PREETHI	Preethi
4	15UP1A0503	BAYYADUGULA PRAVEENA	Praveena
5	15UP1A0504	BEENAMOHINA TEJASVEE YADAV	Tejasvee
6	15UP1A0505	BODIKA SANDHYA RANI	Sandhya
7	15UP1A0506	BOLLOJU RAMYA SMRUTHI	Ramyas
8	15UP1A0507	BOMMA AKHILA	Akhila
9	15UP1A0508	BONTHU TARUNA SRI	Taruna Sri
10	15UP1A0509	BURUGU TEJASRI	Tejasri
11	15UP1A0510	CHENNALA GAYATRI YADAV	Gayatri yadav
12	15UP1A0511	CHINDAM PRANAVA	Pranava
13	15UP1A0512	CHOWDARAPU SRIJA	Srija
14	15UP1A0513	D A DIVYA	Divya
15	15UP1A0514	D ANUSHA	Anusha
16	15UP1A0515	DAMULURI DIVYA	Divya
17	15UP1A0517	DENDUKURU SRIREKHA	SrIREKHA
18	15UP1A0518	DHARNI MANISHA	Manisha
19	15UP1A0519	G VAISHNAVI	Vaishnavi
20	15UP1A0520	GOLEM SUPRAJA CHINMAYEE	Chinmayee
21	15UP1A0522	GULLIPALLI JAHNAVI	Jahnavi
22	15UP1A0523	GUNDA SOWMYA	Sowmya
23	15UP1A0524	GURDEEP KAUR JANDU	Jandur
24	15UP1A0525	K ANUSHA	Anusha
25	15UP1A0526	K SHRUTHI	Shruthi
26	15UP1A0528	KAMBALAPALLY MOUNIKA	Mounika
27	15UP1A0529	KOTIKA SIVA PARVATHI	Parvathi
28	15UP1A0530	KRISHNADHARI SOWJANYA	Sowjanya
29	15UP1A0532	MANJULA DIGAMBER DEVKATTE	Devkatte
30	15UP1A0533	MARPU SWETHA REDDY	Swetha



*ASH*

PRINCIPAL

Vignans Institute of Management & Technology For Women  
Kondapur (V), Ghatkesar (M), Medchal-Malkajgiri (D)-501301  
Telangana State



# VIGNAN'S INSTITUTE OF MANAGEMENT AND TECHNOLOGY FOR WOMEN

Sponsored by Lavu Educational Society, Approved by AICTE, New Delhi & Affiliated to JNTUH, Hyderabad,  
Kondapur (V), Ghatkesar (M), Medchal - Malkajgiri (D) - 501 301 Phone: +91 96529 10002/3



31	15UP1A0534	MOGULURU VENKATA NAGASWETHA	<i>Swetha</i>
32	15UP1A0535	N NIHARIKA REDDY	<i>Niharika</i>
33	15UP1A0536	NAKREKANTI PRASHANTHI	<i>Prashanthi</i>
34	15UP1A0537	NERELLA TEJASWINI	<i>Tejaswini</i>
35	15UP1A0538	PADMAM KRISHNAVENI	<i>Krishnaveni</i>
36	15UP1A0539	PANAGANTI MADHUSHALINI	<i>Madhusalini</i>
37	15UP1A0540	POTHAM JYOSHNA DEVI	<i>Jyoshna</i>
38	15UP1A0541	PULAMONI PRAVALIKA	<i>Pravalika</i>
39	15UP1A0542	PULGAM KAVYA	<i>Kavya</i>
40	15UP1A0544	SARIKONDA POOJA	<i>Pooja</i>
41	15UP1A0545	SRAVANI REDDY BARLAPALLY	<i>Sravani</i>
42	15UP1A0546	SRI RAMA VINEETHA	<i>Vineetha</i>
43	15UP1A0547	SUNKARA SAIMOUNIKA	<i>Mounika</i>
44	15UP1A0549	SWARGAM MOUNIKA	<i>Mounika</i>
45	15UP1A0550	THOUTAM CHANDANA	<i>Chandana</i>
46	15UP1A0551	VALABOJU DIVYA SRI	<i>Divya</i>



*Adh*

PRINCIPAL

Vignans Institute of Management & Technology For Women  
(V), Ghatkesar (M), Medchal-Malkajgiri (D)-501...  
Telangana State



# VIGNAN'S INSTITUTE OF MANAGEMENT AND TECHNOLOGY FOR WOMEN

(Sponsored by Lavu Educational Society)

Approved by AICTE, New Delhi & Affiliated to JNTUH, Hyderabad.

**Kondapur (V), Ghatkesar (M), Medchal - Malkajgiri (D) - 501 301**

In association with:



## Certificate of Participation

This certificate is presented to Ms. .... **K: ANUSHA** .....

for her participation in a seminar on "Neutral Networks and Deep Learning" held on 28th March, 2019, Organized by the Department of Computer Science and Engineering, in association with TAG IT Consulting, Hyderabad.

*K. Bhavathi*  
Co-Ordinator



*V. Indira*  
HoD, CSE

*[Signature]*  
PRINCIPAL  
Vignan's Institute of Management & Technology  
Kondapur (V), Ghatkesar (M), Medchal-Malkajgiri (D)-501 301  
Telangana State

*[Signature]*  
Principal



# VIGNAN'S INSTITUTE OF MANAGEMENT AND TECHNOLOGY FOR WOMEN

[Sponsored by Lavu Educational Society, Approved by AICTE, New Delhi & Affiliated to JNTUH, Hyderabad.]

Kondapur (V), Ghatkesar (M), Medchal - Malkajgiri (D) - 501 301 TS INDIA

Phone: +08415 200006/07/08

Email: info.vmtw.in

VMTW/CSE/CIR/2018-19/II/05

Date: 10/12/2018

## CIRCULAR

This is to inform all the faculties and students that there is a Three-Day Workshop on “**Natural Language Processing Using AI Techniques**” scheduled on 13-12-2018 to 15-12-2018. In this regard students are instructed to attend the workshop without fail.

  
**PRINCIPAL**

PRINCIPAL

Vignan's Institute of Management & Technology For Women  
Kondapur (V), Ghatkesar (M), Medchal-Malkajgiri (Dt)-501301  
Telangana State

Copy to:

1. CEO for information,
2. IQAC,
3. Admin Office,
4. HODs (CSE, IT, ECE, EEE, BSH),
5. All Notice Boards
6. Circulate to all Class Rooms,
7. File.



  
**PRINCIPAL**

Vignan's Institute of Management & Technology For Women  
Kondapur (V), Ghatkesar (M), Medchal-Malkajgiri (Dt)-501301  
Telangana State



# VIGNAN'S INSTITUTE OF MANAGEMENT AND TECHNOLOGY FOR WOMEN

(Approved by AICTE, New Delhi & Affiliated to JNTUH, Hyderabad.)

Kondapur (V), Ghatkesar (M), Medchal - Malkajgiri (D) - 501 301

## DEPARTMENT OF COMPUTER SCIENCE AND ENGINEERING

ORGANIZING

# A THREE-DAY WORKSHOP ON NATURAL LANGUAGE PROCESSING USING AI TECHNIQUES

13<sup>TH</sup> - 15<sup>TH</sup> DECEMBER, 2018  
@ SEMINAR HALL

In association with:



## BRAIN O VISION

Resource Person:

**Mr. Ratnesh Ranjan,**  
Technical Manager,  
Brain O Vision.



Chief Patron:

**Dr. Lavu Rathaiah,**  
Chairman, Vignan Group.

Patron:

**Mr. B. Shruvan,**  
CEO, Vignan Group.

Co-Patron:

**Dr. P. Sudhakar Rao,**  
Principal, VMTW.

Advisor:

**Mrs. V. Indrani,**  
Associate Professor & HOD,  
Dept. of CSE.

Co-Ordinator:

**Mr. V. Jagadeeshwar Reddy,**  
Assistant Professor, CSE.  
Cell: +91 96768 91489



*[Signature]*

PRINCIPAL

Vignans Institute of Management & Technology  
Kondapur(V), Ghatkesar(M), Medchal-Malkajgiri(D) - 501 301  
Telangana State



# VIGNAN'S INSTITUTE OF MANAGEMENT AND TECHNOLOGY FOR WOMEN

[Sponsored by Lavu Educational Society, Approved by AICTE, New Delhi & Affiliated to JNTUH, Hyderabad.]

Kondapur (V), Ghatkesar (M), Medchal - Malkajgiri (D) - 501 301 TS INDIA

Phone: +08415 200006/07/08

Email: info.vmtw.in

## DEPARTMENT OF COMPUTER SCIENCE AND ENGINEERING

### Report on "Natural Language Processing Using AI Techniques"

Date: 18-12-2018

**Event Type** : Workshop  
**Total No. of Participants** : 93  
**Resource Person** : Ratnesh Ranjan  
Technical Manager,  
Brain O Vision.  
**Name of Coordinator** : Mrs. K. Helini

#### **Objective of the Event:**

The Objective of this Workshop focuses on Natural Language Processing (NLP). NLP is a tract of Artificial Intelligence and Linguistics, devoted to make computers understand the statements or words written in human languages.

#### **Outcomes of the Event:**

After completion of the Workshop on "Natural Language Processing using AI Techniques", the students are expected to: Natural language processing provides a way in which human interacts with computer / machines by means of voice.



To furnish the participants to analyze sentences in terms of parts of speech (POS) and constituent structure, including the use of tree diagrams, Natural language processing is an area of research and application that explores how computers can be used to understand and manipulates natural language text or speech to do useful things.

  
**Coordinator**



  
**Head of Department**

Head of The Department  
Computer Science and Engineering  
Vignan's Institute of Management & Technology For Women  
Kondapur (V), Ghatkesar (M), Medchal-Malkajgiri (D)-501301  
Telangana State



**PRINCIPAL**  
Vignan's Institute of Management & Technology For Women  
Kondapur (V), Ghatkesar (M), Medchal-Malkajgiri (D)-501301  
Telangana State



S.No	Roll No	Student Name	13-Dec	14-Dec	15-Dec
1	14UPIA0505	B.Meghana	Megha	Megha	Megha
2	15UPIA0501	ANNAVARAPU HIMA RAJYALAKSHMI	Lakshmi	Lakshmi	Lakshmi
3	15UPIA0502	BASUDE PREETHI	Preethi	Preethi	Preethi
4	15UPIA0503	BAYYADUGULA PRAVEENA	Praveena	Praveena	Praveena
5	15UPIA0504	BEENAMOHINA TEJASVEE YADAV	Tejasa	Tejasa	Tejasa
6	15UPIA0505	BODIKA SANDHYA RANI	Sandhya	Sandhya	Sandhya
7	15UPIA0506	BOLLOJU RAMYA SMRUTHI	Smruthi	Smruthi	Smruthi
8	15UPIA0507	BOMMA AKHILA	Akhila	Akhila	Akhila
9	15UPIA0508	BONTHU TARUNA SRI	Taruna	Taruna	Taruna
10	15UPIA0509	BURUGU TEJASRI	Tejasri	Tejasri	Tejasri
11	15UPIA0510	CHENNALA GAYATRI YADAV	Gayatri	Gayatri	Gayatri
12	15UPIA0511	CHINDAM PRANAVA	Pranava	Pranava	Pranava
13	15UPIA0512	CHOWDARAPU SRIJA	Srija	Srija	Srija
14	15UPIA0513	D A DIVYA	Divya	Divya	Divya
15	15UPIA0514	D ANUSHA	Anusha	Anusha	Anusha
16	15UPIA0515	DAMULURI DIVYA	Divya	Divya	Divya
17	15UPIA0517	DENDUKURU SRIREKHA	Srirekha	Srirekha	Srirekha
18	15UPIA0518	DHARNI MANISHA	Manisha	Manisha	Manisha
19	15UPIA0519	G VAISHNAVI	Vaishnavi	Vaishnavi	Vaishnavi
20	15UPIA0520	GOLEM SUPRAJA CHINMAYEE	Chinmayee	Chinmayee	Chinmayee
21	15UPIA0522	GULLIPALLI JAHNAVI	Jahnavi	Jahnavi	Jahnavi
22	15UPIA0523	GUNDA SOWMYA	Sowmya	Sowmya	Sowmya
23	15UPIA0524	GURDEEP KAUR JANDU	Kaur	Kaur	Kaur
24	15UPIA0525	K ANUSHA	Anusha	Anusha	Anusha
25	15UPIA0526	K SHRUTHI	Shruthi	Shruthi	Shruthi
26	15UPIA0528	KAMBALAPALLY MOUNIKA	Mounika	Mounika	Mounika
27	15UPIA0529	KOTIKA SIVA PARVATHI	Parvathi	Parvathi	Parvathi
28	15UPIA0530	KRISHNADHARI SOWJANYA	Sowjanya	Sowjanya	Sowjanya
29	15UPIA0532	MANJULA DIGAMBER DEVKATTE	Devkatte	Devkatte	Devkatte
30	15UPIA0533	MARPU SWETHA REDDY	Swetha	Swetha	Swetha
31	15UPIA0534	MOGULURU VENKATA NAGASWETHA	Swetha	Swetha	Swetha
32	15UPIA0535	N NIHARIKA REDDY	Niha	Niha	Niha
33	15UPIA0536	NAKREKANTI PRASHANTHI	Prashanti	Prashanti	Prashanti
34	15UPIA0537	NERELLA TEJASWINI	Tejaswini	Tejaswini	Tejaswini
35	15UPIA0538	PADMAM KRISHNAVENI	Krishnaveni	Krishnaveni	Krishnaveni
36	15UPIA0540	PRASAGANTI MADHUSHALINI	Madhus	Madhus	Madhus
37	15UPIA0540	PRASAGANTI MADHUSHALINI	Madhus	Madhus	Madhus
		PRINAM JYOSHNA DEVI	Jyosha	Jyosha	Jyosha



*[Handwritten Signature]*  
PRINCIPAL

Vignans Institute of Management & Technology For Women  
Kandepur(V), Ghatkesar(M), Medchal-Malkajgiri(DT)-501301  
Telangana State

38	15UP1A0541	PULAMONI PRAVALIKA			
39	15UP1A0542	PULGAM KAVYA	Kavya	Kavya	Kavya
40	15UP1A0544	SARIKONDA POOJA	Sari	Sari	Sari
41	15UP1A0545	SRAVANI REDDY BARLAPALLY	Pravani	Pravani	Pravani
42	15UP1A0546	SRI RAMA VINEETHA	Rama	Rama	Rama
43	15UP1A0547	SUNKARA SAIMOUNIKA	Sai	Sai	Sai
44	15UP1A0549	SWARGAM MOUNIKA	Moun	Moun	Moun
45	15UP1A0550	THOUTAM CHANDANA	chandu	chandu	chandu
46	15UP1A0551	VALABOJU DIVYA SRI	Divya	Divya	Divya
47	15UP1A0552	AKULA VANAJA	Vanaja	Vanaja	Vanaja
48	15UP1A0553	AKUULA PRIYANKKA	Priya	Priya	Priya
49	15UP1A0554	ANANTHULA RAVALI	Ravali	Ravali	Ravali
50	15UP1A0555	ANDAM SIRISHA	Sirisha	Sirisha	Sirisha
51	15UP1A0556	BANDI RASHMITHA	Rashmi	Rashmi	Rashmi
52	15UP1A0557	BAREDDY SRAVANTHI	Pravanti	Pravanti	Pravanti
53	15UP1A0559	BOPPIDI ROOPASRI	Rupa	Rupa	Rupa
54	15UP1A0560	CHANDA VARALAXMI	Vara	Vara	Vara
55	15UP1A0562	CHIRABOINA RAMADEVI	Rama	Rama	Rama
56	15UP1A0563	CHOWDAVARAPU LAKSHMI PRIYA	Lakshmi	Lakshmi	Lakshmi
57	15UP1A0564	DARIPALLI AMANI	Amni	Amni	Amni
58	15UP1A0565	EDUKULLA LIKITHA	Likitha	Likitha	Likitha
59	15UP1A0567	GOPISHETTY SAHAJA	Saha	Saha	Saha
60	15UP1A0568	K NAVA JYOTHI	Jyothi	Jyothi	Jyothi
61	15UP1A0569	KANDULA MANMITHA	Manmi	Manmi	Manmi
62	15UP1A0570	KARLA AMULYA	Amul	Amul	Amul
63	15UP1A0571	L SONALI	Sonali	Sonali	Sonali
64	15UP1A0572	MANDADI MOUNIKA	Mouni	Mouni	Mouni
65	15UP1A0573	MARYALA DIKSHITHA	Dikshitha	Dikshitha	Dikshitha
66	15UP1A0574	MENDE KAVYA	Kavya	Kavya	Kavya
67	15UP1A0575	MIRYALA SRI LAKSHMI	Lakshmi	Lakshmi	Lakshmi
68	15UP1A0576	MOOLA VIDYA SRI	Divya	Divya	Divya
69	15UP1A0577	N USHARANI	Ushara	Ushara	Ushara
70	15UP1A0578	NANDINI BANDARU	Nandi	Nandi	Nandi
71	15UP1A0579	NANGUNURI NAVYA SRI	Navya	Navya	Navya
72	15UP1A0580	PENDYALA LASYA PRIYA	Priya	Priya	Priya
73	15UP1A0581	PININTI NIHARIKA REDDY	Nihari	Nihari	Nihari
74	15UP1A0582	PUTTA DEEKSHITHA	Deeksha	Deeksha	Deeksha
75	15UP1A0583	RAMADEVI SEELAM	Rama	Rama	Rama
76	15UP1A0584	RAVAEKOLE MANASA	Manasa	Manasa	Manasa



*Vignana*  
PRINCIPAL

Vignana's Institute of Management & Technology for Women  
Kondapur(V), Ghatkesar(M), Medchal-Malkajgiri(Dt)-501301  
Telangana State

77	15UP1A0585	RAVIRALA HARSHITHA	Harshitha	Harshitha	Harshitha
78	15UP1A0586	RELANGI VIJAYA DURGA	Relangi	Relangi	Relangi
79	15UP1A0587	SAGIREDDY HEVANYA	Hevanya	Hevanya	Hevanya
80	15UP1A0588	SAMALA ANUSHA	Anusha	Anusha	Anusha
81	15UP1A0589	SANTHAPURI VAISHNAVI	Vaishu	Vaishu	Vaishu
82	15UP1A0590	SOMA SHRUTHI	Sourthi	Sourthi	Sourthi
83	15UP1A0591	SUMREDDY ABHINAYA	Abhi	Abhi	Abhi
84	15UP1A0592	SUNKARI SOWMYA REDDY	Sowmya	Sowmya	Sowmya
85	15UP1A0593	TALAPAREDDY SANGHAVI	Sangavi	Sangavi	Sangavi
86	15UP1A0594	THIRMANI BHAVANI	Bhavani	Bhavani	Bhavani
87	15UP1A0595	VEERANALA MANASA	Manasa	Manasa	Manasa
88	15UP1A0596	VELAPATI SOWMYA	Sowmya	Sowmya	Sowmya
89	15UP1A0598	VEMI REDDY LAKSHMI KALYANI	Kalyani	Kalyani	Kalyani
90	15UP1A0599	VODDE DIVYA	Divya	Divya	Divya
91	15UP1A05A 1	VOOTUKURY PRAVALLIKA	Pravallika	Pravallika	Pravallika
92	15UP1A05A 2	VORUGANTI PRAVALLIKA	Pravallika	Pravallika	Pravallika
93	15UP1A05A 3	MAHVEEN ARSHI	Arshi	Arshi	Arshi



*Vignana*  
PRINCIPAL  
Vignana's Institute of Management & Technology For Women  
Kondapur(V), Ghatkesar(M), Medchal-Malkajgiri(Dt)-501301  
Telangana State



# VIGNAN'S INSTITUTE OF MANAGEMENT AND TECHNOLOGY FOR WOMEN

(Sponsored by Lavu Educational Society)

Approved by AICTE, New Delhi & Affiliated to JNTUH, Hyderabad.

Kondapur (V), Ghatkesar (M), Medchal - Malkajgiri (D) - 501 301



**BRAIN O  
VISION**

## Certificate

This certificate is presented to Ms. ....D. ANUSHA.....  
for her participation in a three-day workshop on "Natural Language Processing  
using AI Techniques" held from 13-12-2018 to 15-12-2018, Organized by the  
Department of Computer Science and Engineering, in association with **BRAIN O  
VISION**, Hyderabad.

  
Co-Ordinator

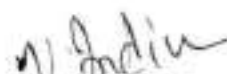

  
HoD, CSE

  
PRINCIPAL  
Vignan's Institute of Management & Technology For Women  
Kondapur (V), Ghatkesar (M), Medchal-Malkajgiri (D),-501301  
Telangana State

  
Principal



VMTW/TPC/CIR/2019-20/08

Date: 16-08-2019

### CIRCULAR

All the HODs and Placement Coordinators are here by requested to inform III B.Tech students that Career Enhancement (FACE) is going to conduct assessments on Quantitative Aptitude, Logical Reasoning, and Verbal Ability & Technical Skills. Starting from 19-08-2019 to 24-08-2019 for III B.Tech students.

Contact T&P Cell for further information

Copy to:

1. CEO for information,
2. All the Deans,
3. IQAC,
4. Admin Office,
5. HODs (CSE, IT, ECE, EEE, BSH),
6. All Notice Board,
7. Circulate to all Class Rooms,
8. File.

PRINCIPAL  
PRINCIPAL

Vignans Institute of Management & Technology For Women  
Kondapur (V), Ghatkesar (M), Medchal-Malkajgiri (Dt.)-501  
Telangana State



PRINCIPAL  
Vignans Institute of Management & Technology For Women  
Kondapur (V), Ghatkesar (M), Medchal-Malkajgiri (Dt.)-501301  
Telangana State



Training & Placement Cell

Date: 26-08-2019

Report on CRT program conducted by FACE

**Name of the Programme:** Campus Recruitment Training

**Syllabus:** Quantitative aptitude, number system, logical reasoning, verbal aptitude. Reading comprehension, computer fundamentals, coding and decoding, group discussion, interview skills, resume writing and email and telephone etiquette.

**Objective:** To train the students in areas such as quantitative aptitude, verbal aptitude, reading comprehension, fundamentals of programming and soft skills to make them ready for placements.

**Name of the Agency:** FACE

**Name of the Instructor:** Sai Kiran

**Dates of the program:** 19-08-2019 to 24-08-2019,

**Number of students attended:** 114

The Program conducted in ASF-7, ASF-8 and ATF-5.



Campus Recruitment Training at ASF-8

**Outcome:** Students were trained in quantitative aptitude, logical reasoning, verbal aptitude, reading comprehension, soft skills, group discussions, interview skills. Resume writing, and email and telephone etiquette, making them ready for campus placements.

The undersigned thanked the respective department coordinators and Focus Academy for Career Enhancement, for their able support in completing the program successfully.



  
PRINCIPAL

Vignans Institute of Management & Technology For Women  
Kondapur(V), Ghatkesar(M), Medchal-Malkajgiri(D)-501301  
Telangana State



# VIGNAN'S INSTITUTE OF MANAGEMENT AND TECHNOLOGY FOR WOMEN

[Sponsored by Lavu Educational Society]

(Approved by AICTE, New Delhi & Affiliated to JNTUH, Hyderabad.)

Kondapur (V), Ghatkesar (M), Medchal - Malkajgiri (D) - 501 301 Phone: +91 96529 10002/3



CSE & ECE

## "Campus Recruitment Training" Attendance Sheet

### 3<sup>rd</sup> CSE attendance Sheet

SN	Roll No	Name	19/08	20/08	21/08	22/08	23/08	24/08
1	18UP1A0501	Anreddy Pooja Sree	P	P	P	P	P	P
2	18UP1A0502	Are Sadhana	P	P	P	P	P	P
3	18UP1A0503	Avula Kavya Sri	P	P	P	P	P	P
4	18UP1A0504	Balne Unvitha	P	P	Ab	P	P	P
5	18UP1A0505	Bandaru Pranathi	P	P	P	P	P	P
6	18UP1A0506	Bellamkonda Vyshnavi	Ab	P	P	P	P	P
7	18UP1A0507	Challa Mahima Chandra	P	P	P	P	P	P
8	18UP1A0508	Dasari Ruchitha	P	P	P	P	P	P
9	18UP1A0509	Deekonda Raaga Priya	P	P	P	P	P	P
10	18UP1A0510	Devandla Swapna	P	P	P	P	P	P
11	18UP1A0511	Devishetti Ashritha	P	P	P	P	P	P
12	18UP1A0512	Eliti Nandini	P	P	P	P	P	P
13	18UP1A0513	Gujja Harshitha Reddy	Ab	P	P	P	P	P
14	18UP1A0514	Gajula Vidya	P	P	P	P	P	P
15	18UP1A0515	Guntur Komali	Ab	P	P	P	P	P
16	18UP1A0516	Jeeyar Prasanna	P	P	P	P	P	P
17	18UP1A0517	K Rishika	P	P	P	P	P	P
18	18UP1A0518	Kamireddy Keerthi Reddy	P	P	P	P	P	Ab
19	18UP1A0519	Kandakatla Navya	P	P	P	P	P	P
20	18UP1A0520	Kappari Sowmya	P	P	P	ab	P	P
21	18UP1A0521	Karla Keerthana	Ab	P	P	P	P	P
22	18UP1A0522	Koppu Alekhya	P	P	P	P	P	P
23	18UP1A0523	Kotha Sravani	P	P	P	P	P	P
24	18UP1A0524	M.Sravani	P	P	P	P	P	P
25	18UP1A0525	Miriyala Reshika	P	P	P	P	P	P
26	18UP1A0526	Molugu Manasa	P	Ab	P	P	P	P
27	18UP1A0527	Mukka Mahima	P	P	P	P	P	P
28	18UP1A0528	M. Yoshnavi Naga Lakshmi	P	P	P	P	Ab	P
29	18UP1A0529	Muppalla Sai Sree	P	P	P	P	P	P
30	18UP1A0530	Nangunuri Akhila	P	P	P	P	P	P
31	18UP1A0531	Neelam Vincela	P	P	P	P	P	P
32	18UP1A0532	Neeluri Rishita	Ab	P	P	P	P	P
33	18UP1A0533	Palvai Nikhitha	P	P	P	P	P	P
34	18UP1A0534	Panjala Chandana	P	P	P	P	P	Ab
35	18UP1A0535	Parsi Varsha	P	P	P	P	P	P
36	18UP1A0536	Pasham Shravani	P	P	P	P	P	P
37	18UP1A0537	Pasunuti Sindhu	P	P	P	P	P	P
38	18UP1A0538	Necharika Patel	P	P	P	P	P	P



PRINCIPAL  
Vignans Institute of Management & Technology for Women  
Kondapur(V), Ghatkesar(M), Medchal-Malkajgiri(D)-501301  
Telangana State



# VIGNAN'S INSTITUTE OF MANAGEMENT AND TECHNOLOGY FOR WOMEN

[Sponsored by Lavu Educational Society]

(Approved by AICTE, New Delhi & Affiliated to JNTUH, Hyderabad.)

Kondapur (V), Ghatkesar (M), Medchal - Malkajgiri (D) - 501 301 Phone: +91 96529 10002/3



39	18UPIA0539	Pothureddypalli Ikyatha	P	P	P	P	P	P	Ab
40	18UPIA0540	Raju Bindu	P	P	P	P	P	P	P
41	18UPIA0541	Raparathi Sathvika	P	P	P	P	P	P	P
42	18UPIA0542	Rapolu Chandana	P	P	P	P	P	P	P
43	18UPIA0543	S Meghana	P	Ab	P	P	P	P	P
44	18UPIA0544	Sai Mounika Viyyapu	P	P	P	P	P	P	P
45	18UPIA0545	Sanka Ramasai	P	P	P	P	P	P	P
46	18UPIA0546	Singaram Priyanshi	P	P	P	P	P	P	P
47	18UPIA0547	Suryadevara Maneesha	P	P	P	Ab	P	P	P
48	18UPIA0548	Telukutla Priyanka	P	P	P	P	P	P	P
49	18UPIA0549	Talapalli Sahithi	P	P	P	P	P	P	P
50	18UPIA0550	Nikhitha Thumula	P	P	P	P	P	P	P
51	18UPIA0551	V.Sravanapragathi	P	P	P	P	P	P	P
52	18UPIA0552	V Shravya	P	P	P	P	Ab	P	P
53	18UPIA0553	Vemula Sai Esha	P	P	P	P	P	P	P
54	18UPIA0554	Volloju Jagadeshwari	Ab	P	P	P	P	P	P
55	18UPIA0555	Vunnam Sushmithasiri	P	P	Ab	P	P	P	P
56	18UPIA0556	Voruganti Rochishna	P	P	P	P	P	P	P
57	18UPIA0557	M. Eswari Sai Sarayu	P	P	P	P	P	P	P
58	18UPIA0558	Indela Dharani	P	P	P	P	P	P	P
59	18UPIA0559	Achalla Yagnamukhi	P	P	P	Ab	P	P	P
60	18UPIA0560	Alapati Harshini	P	P	P	P	P	P	P
61	18UPIA0561	Ankam Jaswitha	P	P	P	P	P	P	P
62	18UPIA0562	A. Bhagya Chandana	P	P	P	P	P	P	P
63	18UPIA0563	Bathina Harshitha	P	P	P	P	P	P	P
64	18UPIA0564	B. Lakshmi Manasa	P	P	P	P	P	P	P
65	18UPIA0565	Bojja Priyanka	P	P	P	P	P	P	P
66	18UPIA0566	Bramanapally Supriya	P	P	P	P	P	P	P
67	18UPIA0567	Cheeli Swetha	P	P	P	P	P	P	P
68	18UPIA0568	Chilam Anuradha	P	P	P	P	P	P	P
69	18UPIA0569	Chirala Ramya	P	P	P	P	P	P	P
70	18UPIA0570	Damsani Srija	P	P	P	P	P	P	P
71	18UPIA0571	Gunda Abhi Sri	P	Ab	P	P	P	P	Ab
72	18UPIA0572	Gandhamalla Hema Latha	P	P	P	P	P	P	P
73	18UPIA0573	Gollapudi Likhita	P	P	P	P	P	P	P
74	18UPIA0574	Gutta Lathika Chowdary	P	P	P	P	P	P	P
75	18UPIA0575	J Lalitha Priya	ab	P	P	P	P	P	P
76	18UPIA0576	Jillala Mysasree	P	P	P	P	P	P	P
77	18UPIA0577	Kallutla Jaya Sindhuri	P	P	P	P	P	P	P
78	18UPIA0578	Korrapati Mrudhula	P	P	Ab	P	P	P	P
79	18UPIA0579	Kota Vasavi Vineetha	P	P	P	P	P	P	P
80	18UPIA0580	Kotha Srinidhi	P	P	P	P	P	P	P
81	18UPIA0581	Kothapalli Pooja Sai Sree	P	P	P	Ab	P	P	P



*[Signature]*  
PRINCIPAL

Vignan's Institute of Management & Technology for Women  
Kondapur (V), Ghatkesar (M), Medchal - Malkajgiri (D) - 501301  
Telangana, India





# VIGNAN'S INSTITUTE OF MANAGEMENT AND TECHNOLOGY FOR WOMEN

[Sponsored by Lawu Educational Society]

(Approved by AICTE, New Delhi & Affiliated to JNTUH, Hyderabad.)

Kondapur (V), Ghatkesar (M), Medchal - Malkajgiri (D) - 501 301 Phone: +91 96529 10002/3



82	18UPIA0582	Machan Anuksha	P	P	P	P	P	P
83	18UPIA0583	Madishetty Manasa	P	P	P	P	Ab	P
84	18UPIA0584	Matroju Shravya	P	P	P	P	P	P
85	18UPIA0585	M.Sharanya Reddy	P	P	P	P	P	P
86	18UPIA0586	M. Harshitha Mahesh	P	P	P	P	P	P
87	18UPIA0587	Miryala Pooja	P	P	P	Ab	P	P
88	18UPIA0588	N Naga Deepthi	P	P	P	P	P	P
89	18UPIA0589	Narikonda Bhanusree	P	P	P	P	P	P
90	18UPIA0590	Neela Akhila	P	P	P	P	P	Ab
91	18UPIA0591	Neelapala Monika	Ab	P	P	P	P	P
92	18UPIA0592	Neeradi Pravalika	P	P	P	P	P	P
93	18UPIA0593	P Hemalatha	P	P	P	P	P	P
94	18UPIA0594	Vamika Patangay	P	P	P	P	P	P
95	18UPIA0595	Raavi Harshitha	P	P	P	P	P	P
96	18UPIA0596	Rakkireddy Vinitha	P	P	P	P	P	P
97	18UPIA0597	Rangu Sushma	P	P	Ab	P	P	P
98	18UPIA0598	Renikindi Ridhima	P	P	P	P	P	P
99	18UPIA0599	Sainikhitha	P	P	P	P	P	P
100	18UPIA05A0	Sakkirolla Sriraaga	P	P	P	P	P	P
101	18UPIA05A1	Samala Akshitha	P	P	P	P	P	P
102	18UPIA05A2	Sangeetha	P	P	P	P	P	P
103	18UPIA05A3	Savalam Bhavani	P	P	P	P	P	P
104	18UPIA05A4	Shaista Sameen	P	P	P	P	P	P
105	18UPIA05A5	Silveri Rasagnya	P	P	P	P	P	Ab
106	18UPIA05A6	Somarouthu Sai Niharika	P	P	P	P	Ab	P
107	18UPIA05A7	Sri Vani Madhav	P	P	P	P	P	P
108	18UPIA05A8	Tadisetti Sravya	P	P	P	P	P	P
109	18UPIA05A9	Thandar Palli Swathi	P	P	P	P	P	P
110	18UPIA05B0	Uppuluri Bharathi	P	P	P	P	P	P
111	18UPIA05B1	Vemula Pavani	P	P	P	P	P	Ab
112	18UPIA05B2	Vinjamuri Navya	P	P	P	P	P	P
113	18UPIA05B3	Y. Sai Venkata Naga Sriya	P	P	P	P	P	P
114	18UPIA05B4	Yerukala Nuthana	P	P	P	Ab	P	P



*rsa*  
**PRINCIPAL**  
 Vignans Institute of Management & Technology For Women  
 Kondapur(V), Ghatkesar(M), Medchal-Malkajgiri(D)-501301  
 Telangana State



# VIGNAN'S INSTITUTE OF MANAGEMENT AND TECHNOLOGY FOR WOMEN

Sponsored by Larvu Educational Society, Approved by AICTE, New Delhi & Affiliated to JNTUH, Hyderabad.  
Kondapur (V), Ghatkesar (M), Medchal - Malkajgiri (D) - 501 301 TS INDIA  
Phone: +08615 200008/07/08 Email: info@vmtw.in

Date: 07-09-2017

VMTW/ TP/CSE//CIR /2017-18/ 19

## CIRCULAR

All the HODs and Placement Coordinators are hereby requested to inform III- B.Tech students that "**Campus Recruitment Training by FACE**" will be conducted in our college starting from 12-09-2017 to 16-09-2017.

Contact T&P Cell for further information.

Copy to:

1. CEO for information,
2. All the Deans,
3. The HOD (CSE / ECE / EEE / IT / AIML / BSH),
4. IQAC,
5. Admin Office,
6. All Notice Boards,
7. Circulate to all Class Rooms,
8. File.

  
PRINCIPAL

PRINCIPAL

Vignan's Institute of Management & Technology For Women  
Kondapur (V), Ghatkesar (M), Medchal - Malkajgiri (D) - 501301

  
PRINCIPAL  
Vignan's Institute of Management & Technology For Women  
Kondapur (V), Ghatkesar (M), Medchal - Malkajgiri (D) - 501301  
Telangana State





# VIGNAN'S INSTITUTE OF MANAGEMENT AND TECHNOLOGY FOR WOMEN

[Sponsored by Lawu Educational Society, Approved by AICTE, New Delhi & Affiliated to JNTUH, Hyderabad.]

Kondapur (V), Ghatkesar (M), Medchal - Malkajgiri (D) - 501 301 TS INDIA

Phone: +08415 200006/07/08

Email: info.vmtw.in

## Schedule of the Program

S.No	Topic	S.No	Topic
1.	Number System	11.	Logical connectives, Syllogism
2.	Ratio and Proportion	12.	Data interpretation and Data sufficient
3.	Profit and loss, Partnerships and Average	13.	Clocks, calendars, Direction sense and Cubes
4.	Time and Work	14.	Reading comprehension
5.	Time, speed and distance	15.	Sentence correction
6.	Percentage, SI and CI	16.	Critical Reasoning.
7.	Permutation, Combination and Probability	17.	Vocabulary
8.	Coding & Decoding, Series, Analogy, Odd man out and Visual reasoning	18.	Sentence completion
9.	Logarithms, progressions, Geometry and quadratic Equations	19.	Articles, Prepositions and Interrogatives
10.	Data arrangements and Blood relations	20.	Voices and Speech



*Wah.*  
PRINCIPAL  
Vignans Institute of Management & Technology For Women  
Kondapur (V), Ghatkesar (M), Medchal - Malkajgiri (D) - 501 301  
Telangana State



Date: 20-09-2017

**Training placement cell**

**Report on CRT Program Conducted by FACE**

**Name of the Programme:** Campus Recruitment Training

**Syllabus:** Coding and decoding, group discussion, interview skills, resume writing Quantitative aptitude, number system, logical reasoning, verbal aptitude. Reading comprehension, computer fundamentals, and email and telephone etiquette.

**Objective:** To train the students in areas such as quantitative aptitude, verbal aptitude, reading comprehension, fundamentals of programming and soft skills to make them ready for placements.

**Name of the Organization:** FACE

**Course instructor:** Sai Kiran

**Dates of the program:** 12-09-2017 to 16-09-2017

**Number of students attended:** 80



**Outcome:** Students were trained in quantitative aptitude, logical reasoning, verbal aptitude, reading comprehension, soft skills, group discussions, interview skills. Resume writing, and email and telephone etiquette, making them ready for campus placements.

The undersigned thanked the respective department coordinators and FACE, for their able support in completing the program successfully.



  
PRINCIPAL  
Vignans Institute of Management & Technology For Women  
Kondapur(V), Ghatkesar(M), Medchal-Malkajgiri(D), TS-501301

Name of the Organization: FACE

Course instructor: SAI KIRAN

**Training & Placement Cell**

**CRT Program Conducted by FACE**

**ECE Attendance Sheet**

S.No	Roll No	Student Name	12/09	13/09	14/09	15/09	16/09
1	15UP1A0401	BEDUDHURI MEGHANA	P	AB	P	P	P
2	15UP1A0402	C VARSHA REDDY	P	P	P	P	P
3	15UP1A0403	CHENNU LAXMI PRASANNA	P	AB	P	P	P
4	15UP1A0405	CHILUMULA RACHANA	P	P	P	AB	P
5	15UP1A0406	CHUNCHU RAMYA SRI	AB	P	AB	P	P
6	15UP1A0407	DADI SHIVANJALI	P	P	P	P	P
7	15UP1A0408	DEVARAKONDA KEERTHI	P	P	P	P	P
8	15UP1A0409	DEVARAKONDA PREETHI	AB	P	P	P	P
9	15UP1A0410	DHODLA ALEKHYA	P	P	AB	P	P
10	15UP1A0411	DUMALA PRIYANKA	P	P	P	P	P
11	15UP1A0412	G VYSHNAVI	P	P	P	P	AB
12	15UP1A0413	GADDAMEEDI ANUSHA	P	P	P	P	P
13	15UP1A0414	GANGAPURAM HIMAJA	P	P	AB	P	P
14	15UP1A0415	GOPALADAS MOUNIKA	AB	P	P	P	P
15	15UP1A0416	GUNDA DEVIKA	P	P	P	P	P
16	15UP1A0417	GUNTI SRAVANI	P	AB	P	P	P
17	15UP1A0418	HARIVENKATANAGA HARIPRIYA	P	P	P	P	P
18	15UP1A0419	JAKKIDI PRANAYA	P	P	AB	P	P
19	15UP1A0420	KAKANI TEJA SRI	P	P	P	P	P
20	15UP1A0421	KANDADI NIKHITHA	AB	P	P	AB	P
21	15UP1A0422	KANDHATI UMA	P	P	P	P	P
22	15UP1A0423	KETHIREDDY PRATHYUSHA	P	P	P	P	AB
23	15UP1A0424	KODEMALA SAIKRUPA	P	AB	P	P	P
24	15UP1A0425	KOLA SONIA	AB	P	P	P	P
25	15UP1A0426	L VIJITHA	P	P	P	P	P
26	15UP1A0427	MAINELLY NIKHITHA	P	P	AB	P	P
27	15UP1A0428	MALLELA MAMATHA	P	P	P	P	P
28	15UP1A0429	MATTI PALLAVI	AB	P	P	AB	P
29	15UP1A0430	MOJJA KAVERI	P	P	P	P	P
30	15UP1A0431	MULLAPUDI VENKATA LIKHITA	P	AB	P	P	P



*SAI KIRAN*  
PRINCIPAL  
Vignana's Institute of Management & Technology For Women  
Kondapur(V), Ghatkesar(M), Medchal-Malkajgiri(DI)-501301  
Telangana State

31	15UP1A0432	PABBA VIKASINI	P	AB	P	P	P
32	15UP1A0434	PALADUGULA SRIKAVYA	P	P	P	P	P
33	15UP1A0435	PAPINENI BHAVANA	P	P	P	AB	P
34	15UP1A0436	PERUGUPALLI VIDYULLEKHA	P	AB	P	P	P
35	15UP1A0437	PINNAPU REDDY RAMYA	P	P	P	P	P
36	15UP1A0438	S AMRUTHA VARSHINI	AB	P	P	P	P
37	15UP1A0439	SALLA VARSHINI	P	P	AB	P	P
38	15UP1A0440	SAMUDRALA NANDINI	P	P	P	AB	P
39	15UP1A0441	SUDAGANI SWETHA	P	P	P	P	P
40	15UP1A0442	VONTARI ARCHANA	P	P	AB	P	P
41	15UP1A0443	ANUCHANDANA MANASA REDDY BODELA	P	P	P	P	P
42	15UP1A0444	BALA THARUNA KEERTHI	P	P	P	P	P
43	15UP1A0445	BANALA PRIYANKA	P	AB	P	P	P
44	15UP1A0446	BANGARAM MAMATHA	P	P	P	AB	P
45	15UP1A0447	BASIREDDY BHARATHI REDDY	P	P	AB	P	P
46	15UP1A0448	BILLAKANTI RAVALI	P	P	P	P	AB
47	15UP1A0449	DEEKONDA SUGANDHA	P	P	P	P	P
48	15UP1A0450	GADDAM JOSHNA	P	P	P	P	AB
49	15UP1A0451	GOGINENI NIKITHA	P	P	P	P	P
50	15UP1A0452	GUNDAGANI NAGASHIRISHA	P	P	P	AB	P
51	15UP1A0453	JALA MOUNIKA	P	P	P	P	P
52	15UP1A0454	K RAMYA REDDY	P	P	AB	P	P
53	15UP1A0455	KANALA KAVYA REDDY	P	P	P	P	P
54	15UP1A0456	KANDUKURI SRAVYA	P	AB	P	P	AB
55	15UP1A0457	KARNATI SRIHARSHA	P	P	P	P	P
56	15UP1A0458	KASULA NAVYA SRI	P	P	P	P	P
57	15UP1A0459	KETHIREDDY RAMYA	P	P	P	P	AB
58	15UP1A0460	KOMATIREDDY SIRIJA	AB	AB	P	P	P
59	15UP1A0461	LAVANYA SEELAM	P	P	P	P	P
60	15UP1A0462	M HARICHANDANA	P	P	P	P	P
61	15UP1A0463	MAHAJAN SRADHA	AB	P	P	P	P
62	15UP1A0464	MANCHALA SHIVAPRIYA	P	P	AB	P	AB
63	15UP1A0465	MANTIPALLY PRAVALIKA	P	P	P	P	P
64	15UP1A0466	METTU SRAVANTHI	P	P	P	P	AB
65	15UP1A0467	MUNAGALA YASHASWINI	AB	P	P	P	P
66	15UP1A0468	NAGANOLLU ANUSHA REDDY	P	P	AB	P	P
67	15UP1A0469	PACHA VEDASRI	P	AB	P	P	P
68	15UP1A0470	PENUJIPATI YASHASWINI	P	P	P	AB	P



  
**PRINCIPAL**  
 Vignans Institute of Management & Technology For Women  
 Kondapur (V), Ghatkesar (M), Medchal-Malkajgiri (D)-501301  
 Telangana State

69	15UP1A0471	PERAMALLA KAVYA	P	P	P	AB	P
70	15UP1A0472	POCHAMPALLY PRIYANKA	P	P	AB	P	P
71	15UP1A0473	POTHEPAKA MANASA	P	AB	P	P	P
72	15UP1A0474	SHEELA NIKITHA	AB	P	P	P	AB
73	15UP1A0475	SHERIKAR PRIYANKA	P	AB	P	P	P
74	15UP1A0476	SHIVA NIKHITHA	P	P	AB	P	P
75	15UP1A0477	SUNKI KALYANI	P	P	P	AB	P
76	15UP1A0478	VEMURI MAHATHI	P	P	P	P	AB
77	15UP1A0479	YASA MINISHA REDDY	P	P	P	AB	P
78	15UP1A0480	YERUVA SAGAR BALA DIVYA	P	P	AB	P	P
79	16UP5A0401	K.DIVYA	P	AB	P	P	P
80	15C31A0432	GADILA PRASANNA LAXMI	AB	P	P	P	P



*[Handwritten Signature]*  
 PRINCIPAL  
 Vignans Institute of Management & Technology For Women  
 Kondapur(V), Ghatkesar(M), Medchal, Malkajgiri(Dy), Pin-501301  
 Telangana State



# VIGNAN'S INSTITUTE OF MANAGEMENT AND TECHNOLOGY FOR WOMEN

Sponsored by Lavu Educational Society, Approved by AICTE, New Delhi & Affiliated to JNTUH, Hyderabad.  
Kondapur (V), Ghatkesar (M), Medchal - Malkajgiri (D) - 501 301 TS INDIA  
Phone: +08615 200008/07/08 Email: info@vmtw.in

## DEPARTMENT OF ELECTRONICS AND COMMUNICATION ENGINEERING

VMTW/ECE/AOC/CIR/2017-18/I/01

Date: 16-08-2017

### CIRCULAR

This is to inform all the IV B. Tech ECE students that, the Department organizing an Add on course on "Controlling of Electrical appliances through Arduino". Department advisory committee has been identified Mr.K.JAGDESHWAR REDDY, Sr.Engineer in ELEGENT for the course. He has an efficient and fine knowledge about that add on course, hence he will available 35 days to complete the course, which will take place from 21-08-2017 to 28-09-2017. The participating students will be honored with certificates of participation. During the course you will be encouraged to interact with the speaker and the other participants through the case study discussions.

  
HOD

Copy to

The Principal, for kind information

IQAC

Notice board

IV.B.Tech students

Dept. file



  
Vignans Institute of Management & Technology For Women  
Kondapur (V), Ghatkesar (M), Medchal - Malkajgiri (D)  
Telangana - 501301



### About the Course:

The concept, of course, is this project is to develop a home automation system using an Arduino board with Bluetooth to be remotely controlled by any Android OS smartphone. As technology is advancing so houses are also getting smarter. Modern houses gradually shift from conventional switches to centralized control systems, involving remote-controlled switches. Presently, conventional wall switches in different parts of the house make it difficult for the user to go near them to operate. Even more, it becomes more difficult for the elderly or physically handicapped people to do so. The remote-controlled home automation system provides a most modern solution with smartphones. In order to achieve this, a Bluetooth module is interfaced to the Arduino board at the receiver end while on the transmitter end, a GUI application on the cell phone sends ON/OFF commands to the receiver where loads are connected. By touching the specified location on the GUI, the loads can be turned ON/OFF remotely through this technology. The loads are operated by Arduino board through optoisolators and thyristors using triacs.

### Course Objectives:

- Automation
- Remote Control
- Integration and Customization

- Energy Monitoring and Conservation
- Learning and Experimentation

### Expected Outcomes:

At the end of Workshop, participants will be able to

- Automation
- Remote Control
- Energy efficiency
- Safety enhancements
- Data logging and analysis
- Integration with other systems



PRINCIPAL

Vignans Institute of Management & Technology For Women  
Kondapur (V), Ghatkesar (M), Medchal - Malkajgiri (D) - 501301  
Telangana State



Resource Person:

**Mr. K. Jagadeeshwar Reddy,**

Director,

Elegant Embedded Solutions Pvt. Ltd.,  
Hyderabad.

Co-ordinator:

**Mr. M. Karthik Pal,**

Assistant Professor, Dept. of ECE,  
Contact No: +91 96769 43133

**Last Date For Registration: 18<sup>th</sup> Aug, 2017**

 **VIGNAN'S**  
INSTITUTE OF MANAGEMENT AND  
TECHNOLOGY FOR WOMEN

(Sponsored by Lavu Educational Society)

Approved by AICTE, New Delhi & Affiliated to JNTUH, Hyderabad.  
Kondapur (V), Ghatkesar (M), Medchal - Malkajgiri (D) - 501 301



ADD-ON COURSE ON

**“CONTROLLING OF  
ELECTRICAL APPLIANCES  
THROUGH ARDUINO”**

**21<sup>ST</sup> AUG TO 28<sup>TH</sup> SEP, 2017**

Duration of the Course: **35 Hrs**

Venue:

**‘B’-Block Seminar Hall, VMTW.**

Organized By:

**DEPARTMENT OF ELECTRONICS AND  
COMMUNICATION ENGINEERING**



# VIGNAN'S INSTITUTE OF MANAGEMENT AND TECHNOLOGY FOR WOMEN

Sponsored by Lavu Educational Society, Approved by AICTE, New Delhi & Affiliated to JNTUH, Hyderabad.  
Kondapur (V), Ghatkesar (M), Medchal - Malkajgiri (D) - 501 301 TS INDIA  
Phone: +08815 200006/07/08 Email: info@vmtw.in

## DEPARTMENT OF ELECTRONICS AND COMMUNICATION ENGINEERING

ADD ON COURSE NAME: **Controlling of Electrical appliances through Arduino**

### DAY WISE SCHEDULE SHEET

Academic Year: 2017-2018

Date : 16-08-2017

B.Tech IV-I SEM

SECTION: ECE-A

Room number: B-BLOCK SEMINAR HALL

S.NO	DAY	Topic	Timings	Duration
1.	21-Aug-17	Introduction to embedded systems.	04:00pm to 05:00pm	1 hour
2.	22-Aug-17	Components of embedded system	04:00pm to 05:00pm	1 hour
3.	23-Aug-17	Advantages and applications of embedded systems	04:00pm to 05:00pm	1 hour
4.	24-Aug-17	Advantages and applications of embedded systems	04:00pm to 05:00pm	1 hour
5.	25-Aug-17	Different Microcontroller Architectures (CISC, RISC, ARISC)	04:00pm to 05:00pm	1 hour
6.	26-Aug-17	Internal Resources & Hardware Chips in Details.	04:00pm to 05:00pm	1 hour
7.	28-Aug-17	History of AVR Microcontrollers and Features	04:00pm to 06:00pm	2 hours
8.	29-Aug-17	Memory Architectures (RAM/ROM)	04:00pm to 05:00pm	1 hour
9.	30-Aug-17	Learning Arduino Platform	04:00pm to 05:00pm	1 hour
10.	31-Aug-17	Introduction to ARDUINO, ARDUINO History and Family	04:00pm to 05:00pm	1 hour
11.	1-Sep-17	Programming in Embedded-C, Concepts of C language	04:00pm to 06:00pm	2 hours
12.	2-Sep-17	General Hardware Interfacings:	04:00pm to 05:00pm	1 hour
13.	4-Sep-17	Introduction to sensors and actuators	04:00pm to 05:00pm	1 hour



  
PRINCIPAL  
Vignans Institute of Management & Technology for Women  
Kondapur(V), Ghatkesar(M), Medchal-Malkajgiri(D)-501301  
Telangana State

14.	5-Sep-17	How to connect and work with different sensors, such as Humidity	04:00pm to 05:00pm	1 hour
15.	6-Sep-17	Proximity, IR Motion, Accelerometer, Sound, Light Distance, Pressure,	04:00pm to 05:00pm	1 hour
16.	7-Sep-17	Thermal etc to ARDUINO Board	04:00pm to 05:00pm	1 hour
17.	8-Sep-17	. Reading various sensor data on serial monitor and LCD Display	04:00pm to 05:00pm	1 hour
18.	11-Sep-17	Functioning of actuator	04:00pm to 05:00pm	1 hour
19.	12-Sep-17	Controlling embedded system based devices using Arduino	04:00pm to 05:00pm	1 hour
20.	13-Sep-17	Reading data from analog and digital sensors on Serial Monitor/LCD Monitor.	04:00pm to 05:00pm	1 hour
21.	14-Sep-17	Work with LED Controlled by Switch/potentiometer, 7 segment displays	04:00pm to 05:00pm	1 hour
22.	15-Sep-17	How to connect relays and servomotors to ARDUINO Board.	04:00pm to 06:00pm	2 hours
23.	18-Sep-17	Work with 5V/3V Power supply using voltage regulator IC'S.	04:00pm to 05:00pm	1 hour
24.	19-Sep-17	Project Based on embedded system design using Arduino board	04:00pm to 05:00pm	1 hour
25.	20-Sep-17	ARDUINO based home automation	04:00pm to 05:00pm	1 hour
26.	21-Sep-17	ARDUINO Based Alarm Clock	04:00pm to 05:00pm	1 hour
27.	22-Sep-17	ARDUINO Based Car Parking System, etc	04:00pm to 05:00pm	1 hour
28.	23-Sep-17	Arduino Integrated Development Environment Software	04:00pm to 05:00pm	1 hour
29.	25-Sep-17	ARDUINO Development Board with ATmega8 Microcontroller	04:00pm to 05:00pm	1 hour
30.	26-Sep-17	How to connect relays and servomotors to ARDUINO Board.	04:00pm to 05:00pm	1 hour
31.	27-Sep-17	Project Based on embedded system design using Arduino board	04:00pm to 05:00pm	1 hour
32.	28-Sep-17	Test conducted & Feedback taken	04:00pm to 05:00pm	1 hour
Total 35 hours				

M. K. K. K.  
Coordinator



HOD

PRINCIPAL  
Vignesh's Institute of Management & Technology For Women  
Malkajgiri (Dt)-501301



# VIGNAN'S INSTITUTE OF MANAGEMENT AND TECHNOLOGY FOR WOMEN

Sponsored by Vignani Educational Society, Approved by AICTE, New Delhi & Affiliated to JNTU, Hyderabad.  
Kondapur (V), Ghatkesar (M), Medchal - Malkajgiri (D) - 501 301 TS INDIA  
Phone: +91815 200006/07/08 Email: info@vmtw.in

## DEPARTMENT OF ELECTRONICS AND COMMUNICATION ENGINEERING

Academic Year: 2017-18

Date: 18-08-2017

ADD ON COURSE NAME: Controlling of Electrical appliances through Arduino

B.Tech IV-I SEM COURSE REGISTRATION FORM SECTION: ECE-A

S.NO	ROLL NUMBER	NAME OF THE STUDENT	SIGNATURE
1	13UPIA0466	N VINDHYA	<i>Vindhya</i>
2	14UPIA0401	BUKYA MOUNIKA	<i>B. Mounika</i>
3	14UPIA0402	G. NAVANEETHA	<i>G. Navaneetha</i>
4	14UPIA0403	SEPURI NAVYA	<i>Navya</i>

*M. Keshikpal*  
COORDINATOR

*[Signature]*  
HOD

Head of the Department  
Electronics and Communication Engineering  
Vignani's Institute of Management & Technology  
Kondapur (V), Ghatkesar (M), Medchal-Malkajgiri (D)



*[Signature]*  
PRINCIPAL

Vignani's Institute of Management & Technology  
Kondapur(V), Ghatkesar(M), Medchal-Malkajgiri(D)-501301  
Telangana State



# VIGNAN'S INSTITUTE OF MANAGEMENT AND TECHNOLOGY FOR WOMEN

Sponsored by Devi Educational Society, Approved by AICTE, New Delhi & Affiliated to JNTUH, Hyderabad.  
Kondapur (V), Ghatkesar (M), Medchal - Malkajgiri (D) - 501 301 TS INDIA  
Phone: +08615 200006/07/08 Email: info@vmtw.in

## DEPARTMENT OF ELECTRONICS AND COMMUNICATION ENGINEERING

Academic Year: 2017-18

Date: 21-08-2017

ADD ON COURSE NAME: Controlling of Electrical appliances through Arduino

B.Tech IV-I SEM STUDENT REGISTERED LIST SECTION: ECE-A

S.NO	ROLL NUMBER	NAME OF THE STUDENT
1	13UPIA0466	N VINDHYA
2	14UPIA0401	BUKYA MOUNIKA
3	14UPIA0402	GANGARAMAINA NAVANEETHA
4	14UPIA0403	SEPURI NAVYA

*M. K. Lakshmi*  
COORDINATOR

*[Signature]*  
HOD

Head of the Department  
Electronics and Communication Engineering  
Vignani's Institute of Management & Technology  
Kondapur (V), Ghatkesar (M), Medchal - Malkajgiri (D) - 501301



*[Signature]*  
PRINCIPAL

Vignani's Institute of Management & Technology For Women  
Kondapur(V), Ghatkesar(M), Medchal-Malkajgiri(D)-501301  
Telangana State



# VIGNAN'S INSTITUTE OF MANAGEMENT AND TECHNOLOGY FOR WOMEN

Sponsored by Vignani Educational Society, Approved by AICTE, New Delhi & Affiliated to JNTU, Hyderabad.  
Kondapur (V), Ghatkesar (M), Medchal - Malkajgiri (Dt) - 501 301 TS INDIA  
Phone: +08615 200006/07/08 Email: info@vmbwin

## DEPARTMENT OF ELECTRONICS AND COMMUNICATION ENGINEERING

Academic Year: 2017-18

Date: 21-08-2017

ADD ON COURSE NAME: Controlling of Electrical appliances through Arduino

B.Tech VI-ISEM

DAY WISE ATTENDANCE SHEET

SECTION: ECE-A

S.No	Roll Number	21-Aug-17	22-Aug-17	23-Aug-17	24-Aug-17	25-Aug-17
1	13UP1A0466	Vindhya	Vindhya	Vindhya	Vindhya	Vindhya
2	14UP1A0401	B. Manika	B. Manika	B. Manika	B. Manika	B. Manika
3	14UP1A0402	A	A	A	A	A
4	14UP1A0403	Ataya	Ataya	Ataya	Ataya	Ataya

M. Kishorpal  
COORDINATOR

HOD

Head of the Department  
Electronics and Communication Engineering  
Vignani's Institute of Management & Technology For Women  
Kondapur (V), Ghatkesar (M), Medchal-Malkajgiri (Dt) - 501 301



PRINCIPAL  
Vignani's Institute of Management & Technology For Women  
Kondapur(V), Ghatkesar(M), Medchal-Malkajgiri(Dt)-501301  
Telangana State



# VIGNANI'S INSTITUTE OF MANAGEMENT AND TECHNOLOGY FOR WOMEN

Sponsored by Vignani Educational Society, Approved by AICTE, New Delhi & Affiliated to JNTU, Hyderabad  
 Ghatkesar (V), Ghatkesar (M), Medchal - Malkajgiri (D) - 501 301 TS INDIA  
 Phone: +08615 200006/07/08 Email: info@vmtw.in

## DEPARTMENT OF ELECTRONICS AND COMMUNICATION ENGINEERING

ADD ON COURSE NAME: Controlling of Electrical appliances through Arduino

Academic Year: 2017-18

Date: 26-08-2017

B.Tech VI-I SEM

DAY WISE ATTENDANCE SHEET

SECTION: ECE-A

S.No	Roll number	26-Aug-17	28-Aug-17	29-Aug-17	30-Aug-17	31-Aug-17
1	13UP1A0466	Vindhya	AB	Vindhya	Vindhya	Vindhya
2	14UP1A0401	B. Manika	B. Manika	B. Manika	B. Manika	B. Manika
3	14UP1A0402	A	A	A	AB	A
4	14UP1A0403	Jaya	Jaya	Jaya	Jaya	Jaya

M. Lakshmi  
 COORDINATOR

HOD

Head of the Department  
 Electronics and Communication Engineering  
 Vignani's Institute of Management & Technology For Women  
 Ghatkesar (V), Ghatkesar (M), Medchal-Malkajgiri (D) - 501 301



PRINCIPAL

Vignani's Institute of Management & Technology For Women  
 Ghatkesar(V), Ghatkesar(M), Medchal-Malkajgiri(D) - 501 301  
 Telangana State



# VIGNAN'S INSTITUTE OF MANAGEMENT AND TECHNOLOGY FOR WOMEN

Sponsored by Vignans Educational Society, Approved by AICTE, New Delhi & Affiliated to JNTU, Hyderabad.  
Kondapur (V), Ghatkher (M), Medchal - Malkajgiri (D) - 501 301 TS INDIA  
Phone: +91 815 200066/07/08 Email: info@vignans.in

## DEPARTMENT OF ELECTRONICS AND COMMUNICATION ENGINEERING

ADD ON COURSE NAME: Controlling of Electrical appliances through Arduino

Academic Year: 2017-18

Date: 01-09-2017

B.Tech VI-I SEM

DAY WISE ATTENDANCE SHEET

SECTION: ECE-A

S.No	Roll number	1-Sep-17	2-Sep-17	4-Sep-17	5-Sep-17	6-Sep-17
1	13UPIA0466	Vindhya	Vindhya	Vindhya	Vindhya	Vindhya
2	14UPIA0401	B. Mounika	B. Mounika	B. Mounika	B. Mounika	B. Mounika
3	14UPIA0402	A	A	A	A	A
4	14UPIA0403	Jaya	Jaya	Jaya	Jaya	Jaya

M. Kasthikped  
COORDINATOR

HOD

Head of the Department  
Electronics and Communication Engineering  
Vignans Institute of Management & Technology For Women  
Kondapur (V), Ghatkher (M), Medchal - Malkajgiri (D) - 501301



Vignans Institute of Management & Technology For Women  
Kondapur (V), Ghatkher (M), Medchal - Malkajgiri (D) - 501301  
Telangana State





# VIGNANI'S INSTITUTE OF MANAGEMENT AND TECHNOLOGY FOR WOMEN

Womens Educational Society, Approved by AICTE, New Delhi & Affiliated to JNTUW, Hyderabad.  
 Gandhinagar (V), Ghatakwar (M), Medchal - Malkajgiri (D) - 501 301 TS INDIA  
 Phone: +91 915 200006/07/08 Email: info@vmtw.in

## DEPARTMENT OF ELECTRONICS AND COMMUNICATION ENGINEERING

ADD ON COURSE NAME: Controlling of Electrical appliances through Arduino

Academic Year: 2017-18

Date: 07-09-2017

B.Tech VI-I SEM

DAY WISE ATTENDANCE SHEET

SECTION: ECE-A

S.NO	Roll number	7-Sep-17	8-Sep-17	11-Sep-17	12-Sep-17	13-Sep-17
1	13UP1A0466	Vindhyas	AB	Vindhyas	Vindhyas	Vindhyas
2	14UP1A0401	B. Maxinika	B. Maxinika	B. Maxinika	B. Maxinika	B. Maxinika
3	14UP1A0402	A	A	A		A
4	14UP1A0403	Janya	Janya	Janya	Janya	Janya

M. K. Kulkarni  
 COORDINATOR

HOD

Head of the Department  
 Electronics and Communication Engg  
 Vignani's Institute of Management & Technology  
 Gandhinagar (V), Ghatakwar (M), Medchal-Malkajgiri (D)-501301



PRINCIPAL  
 Vignani's Institute of Management & Technology For Women  
 Gandhinagar (V), Ghatakwar (M), Medchal-Malkajgiri (D)-501301  
 Telangana State



# VIGNANI'S INSTITUTE OF MANAGEMENT AND TECHNOLOGY FOR WOMEN

Sponsored by Vignani Educational Society, Approved by AICTE, New Delhi & Affiliated to JNTU, Hyderabad.  
Kondapur (V), Ghatkesar (M), Medchal - Malkajgiri (Dt) - 501 301 TS INDIA  
Phone: +08015 200006/07/08 Email: info@vignani.in

## DEPARTMENT OF ELECTRONICS AND COMMUNICATION ENGINEERING

ADD ON COURSE NAME: Controlling of Electrical appliances through Arduino

Academic Year: 2017-18

Date: 14-09-2017

B.Tech VI-I SEM

DAY WISE ATTENDANCE SHEET

SECTION: ECE-A

S.No	Roll number	14-Sep-17	15-Sep-17	18-Sep-17	19-Sep-17	20-Sep-17
1	13UP1A0466	Vindhy	Vindhy	Vindhy	Vindhy	Vindhy
2	14UP1A0401	B. Mounika	B. Mounika	B. Mounika	B. Mounika	B. Mounika
3	14UP1A0402	A	A	AB	A	A
4	14UP1A0403	Janya	Janya	Janya	Janya	Janya

M. Keshik Reddy  
COORDINATOR

[Signature]  
HOD

Head of the Department  
Electronics and Communication Engineering  
Vignani's Institute of Management & Technology For Women  
Kondapur (V), Ghatkesar (M), Medchal-Malkajgiri (Dt) - 501301



[Signature]  
PRINCIPAL

Vignani's Institute of Management & Technology For Women  
Kondapur (V), Ghatkesar (M), Medchal-Malkajgiri (Dt) - 501301  
Telangana State



# VIGNAN'S INSTITUTE OF MANAGEMENT AND TECHNOLOGY FOR WOMEN

Sponsored by Vignan Educational Society, Approved by AICTE, New Delhi & Affiliated to JNTUH, Hyderabad.  
Kondapur (V), Ghatkesar (M), Medchal - Malkajgiri (D) - 501 301 TS INDIA  
Phone: +91515 200006-07/08 Email: info@vmtw.in

## DEPARTMENT OF ELECTRONICS AND COMMUNICATION ENGINEERING

ADD ON COURSE NAME: Controlling of Electrical appliances through Arduino

Academic Year: 2017-18

Date: 21-09-2017

B.Tech VI-I SEM

DAY WISE ATTENDANCE SHEET

SECTION: ECE-A

S.No	Roll number	21-Sep-17	22-Sep-17	23-Sep-17	25-Sep-17	26-Sep-17
1	13UP1A0466	Vindhya	Vindhya	Vindhya	Vindhya	Vindhya
2	14UP1A0401	B. Mounika	B. Mounika	B. Mounika	B. Mounika	B. Mounika
3	14UP1A0402	A	A	AB	A	A
4	14UP1A0403	Ajaya	Ajaya	Ajaya	Ajaya	Ajaya

M. Keshi Reddy  
COORDINATOR

AB  
HOD

Head of the Department  
Electronics and Communications Engineering  
Vignan's Institute of Management & Technology For Women  
Kondapur (V), Ghatkesar (M), Medchal - Malkajgiri (D) - 501 301



Principal  
Vignan's Institute of Management & Technology For Women  
Kondapur (V), Ghatkesar (M), Medchal - Malkajgiri (D) - 501 301



# VIGNAN'S INSTITUTE OF MANAGEMENT AND TECHNOLOGY FOR WOMEN

Sponsored by Vignans Educational Society, Approved by AICTE, New Delhi & Affiliated to JNTUH, Hyderabad.  
Kondapur (V), Ghatkesar (M), Medchal - Malkajgiri (D) - 501 301 TS INDIA  
Phone: +08015 200006/07/08 Email: info@vmbw.in

## DEPARTMENT OF ELECTRONICS AND COMMUNICATION ENGINEERING

ADD ON COURSE NAME: Controlling of Electrical appliances through Arduino

Academic Year: 2017-18

Date: 27-09-2017

B.Tech VI-I SEM

DAY WISE ATTENDANCE SHEET

SECTION: ECE-A

S.No	Roll number	27-Sep-17	28-Sep-17
1	13UP1A0466	Vindhya	Vindhya
2	14UP1A0401	B.Mounik	B.Mounik
3	14UP1A0402	AB	AB
4	14UP1A0403	AB	AB

M. Lakshmi Reddy  
COORDINATOR

HOD

Head of the Department of  
Electronics and Communication Engineering  
Vignans Institute of Management & Technology For Women  
Kondapur (V), Ghatkesar (M), Medchal-Malkajgiri (D) - 501301



PRINCIPAL  
Vignans Institute of Management & Technology For Women  
Kondapur (V), Ghatkesar (M), Medchal-Malkajgiri (D) - 501301  
Telangana, India



# VIGNAN'S INSTITUTE OF MANAGEMENT AND TECHNOLOGY FOR WOMEN

Sponsored by Lavu Educational Society, Approved by AICTE, New Delhi & Affiliated to JNTUH, Hyderabad.  
Kondapur (V), Ghatkesar (M), Medchal - Malkajgiri (D) - 501 301 TS INDIA  
Phone: +08615 200006/07/08 Email: info@vmtw.in

## DEPARTMENT OF ELECTRONICS AND COMMUNICATION ENGINEERING

Date: 30-09-2017

### PROGRAM REPORT

Name of the Add on Course: Controlling of Electrical appliances through Arduino

Day/Duration: 35 Hours

Time: 4pm to 5pm

Resource Person: Mr. K. JAGDEESHWAR REDDY, Sr. Engineer in Elegant Embedded Solutions Pvt. Ltd. Hyderabad

Name of the Coordinator: Mr. M. Karthikpal, Assistant Professor Dept. of ECE, VMTW, Hyderabad

Number of the Participants: 4

**Topics covered:** The following topics covered in this program

1. Home automation system using an Arduino
2. Integration with other systems

**Course Outcomes:**

COs	At the end of the course, students will have the ability to:	Pos Mapped	Strength of mapping
CO1	Recall the basics of sensors, its functioning.	PO1,PO2	2
CO2	Execute basic and advanced assembly language programs	PO3,PO5	3
CO3	Learn the ways to interface I/O devices with processor for task sharing.	PO3,PO4	3
CO4	Recall the basics of co-processor and its ways to handle float values by its instruction set	PO2,PO5	2
CO5	Recognize the functionality of micro controller, latest version processors and its applications	PO3,PO4	3

**Assessment Procedure:** The assessment of the Add on course is conducted in Multiple Choice Questions through offline Mode.

*M. Karthikpal*  
COORDINATOR

*[Signature]*  
HOD



*[Signature]*  
PRINCIPAL  
Vignans Institute of Management & Technology For Women  
Kondapur(V),Ghatkesar(M),Medchal-Malkajgiri(DI)-501301  
Telangana State



# VIGNAN'S INSTITUTE OF MANAGEMENT AND TECHNOLOGY FOR WOMEN

Approved by AICTE, New Delhi & Affiliated to JNTUH, Hyderabad.  
Kondapur (V), Ghatkesar (M), Medchal - Malkajgiri (D) - 501 301

## Certificate of Course Completion

This is to certify that Ms./Mr. **BUKYA MOUNIKA**

Roll No. **14UP1A0401**

Year **IV**

has successfully completed the Add-On / Certification Course on

**Controlling of Electrical Appliance through Arduino**

held from **21-08-2017**

to **28-09-2017**



**Head of the Department, ECE**

Head of the Department

Vignan's Institute of Management and Technology for Women  
Kondapur (V), Ghatkesar (M), Medchal - Malkajgiri (D) - 501 301

**PRINCIPAL**

Vignan's Institute of Management & Technology For Women  
Kondapur(V), Ghatkesar(M), Medchal-Malkajgiri(D)-501301  
Telangana State

**Principal**

PRINCIPAL

Vignan's Institute of Management & Technology For Women  
Kondapur(V), Ghatkesar(M), Medchal-Malkajgiri(D)-501301  
Telangana State



# VIGNAN'S INSTITUTE OF MANAGEMENT AND TECHNOLOGY FOR WOMEN

Sponsored by Lavu Educational Society, Approved by AICTE, New Delhi & Affiliated to JNTUH, Hyderabad.  
Kondapur (V), Ghatkesar (M), Medchal - Malkajgiri (D) - 501 301 Phone: +91 96529 10002/3



## DEPARTMENT OF ELECTRONICS AND COMMUNICATION ENGINEERING

VMTW/ECE/AOC/CIR/2021-22/I-SEM/02

11-09-2021

### CIRCULAR

This is to inform all the III B.Tech ECE students that there will be a Value Added course on "Design of Smart Antenna Systems and Its Importance " in association with Elegant Embedded Solutions Pvt. Ltd from 17-09-2021 to 02-11-2021 All students are invited to take part in this course. The participating students will be honored with certificates of participation. During the course you will be encouraged to interact with the speaker and the other participants through the case study discussions. Hence those who are interested can sign in registration form.



HOD

Head of the Department  
Electronics and Communication Engineering  
Vignans Institute of Management and Technology For Women  
Kondapur (V), Ghatkesar (M), Medchal - Malkajgiri (D) - 501 301

#### Copy to

- The Principal, for kind information
- IQAC
- Notice board
- II.B. Tech students
- Dept. file



PRINCIPAL  
Vignans Institute of Management & Technology For Women  
Kondapur(V),Ghatkesar(M),Medchal-Malkajgiri(D)-501301  
Telangana State

## ABOUT THE COURSE

In this course, introduce about Antenna Theory: Antennas, Radiation concept, Types of Antennas, Antenna parameters, Friis Transmission equation Aperture Antenna: Introduction Microstrip Radiators: Introduction, Rectangular Microstrip Antenna analysis and Design, Circular Microstrip Antenna Analysis and Design, Microstrip Slot Antennas: Wave guide fed slots, Radiation mechanism, Microstrip slot antennas, Introduction to rectangular slot antennas, narrow, wide, tapered and circularly polarized slot antennas, Annular slot antennas, Comparison of microstrip slot antennas with patch antennas. Micro Strip Antenna Arrays: Introduction, Micro strip array antennas, Characteristics of fixed beam linear antenna arrays, Linear microstrip arrays, Characteristics of planar arrays, Microstrip planar arrays, Microstrip scanned array antennas, Phase scanned microstrip arrays, Time delay scanning, Electronic feed switching, Frequency scanned microstrip arrays.

## COURSE OBJECTIVES

To familiarize the basic concepts of antenna parameters and radiation mechanism. To

analyze aperture antennas with the knowledge of various theorems. To study the principles of frequency independent antenna design. To understand, analyze and synthesize array antennas and also know the concepts of smart antennas.

## EXPECTED OUTCOMES

The student will be able to Analyze the different types of antennas with the help of basic antenna fundamentals. Utilize the various microwave antennas by understanding the principle of working of it. Apply the knowledge in the design of various microwave aperture antennas. Acquire basic knowledge of smart antenna design.



Resource Person

**Mr. A. Venkat Reddy,**

Senior Engineer,

Elegant Embedded Solutions Pvt. Ltd.,  
Hyderabad.

Co-ordinator:

**Mr. G. Ganesh Reddy,**

Assistant Professor,  
Department of ECE,

Contact No: +91 99514 07307

**LAST DATE FOR REGISTRATION: 11<sup>TH</sup> SEPTEMBER, 2021**



(Sponsored by Lavu Educational Society)  
Approved by AICTE, New Delhi & Affiliated to JNTUH, Hyderabad.  
Kondapur (V), Ghatkesar (M), Medchal - Malkajgiri (D) - 501 301

**VALUE ADDED COURSE ON  
"DESIGN OF  
SMART ANTENNA SYSTEMS  
AND ITS IMPORTANCE"  
17<sup>TH</sup> SEP TO 2<sup>ND</sup> NOV, 2021**

IN COLLABORATION WITH:



**PRINCIPAL ELEGANT EMBEDDED SOLUTIONS PVT. LTD.**

Vignan's Institute of Management & Technology For Women  
Kondapur(V), Ghatkesar(M), Medchal-Malkajgiri(D)  
Telangana State

**DURATION OF THE COURSE : 30 HRS**

**VENUE: 'B'-BLOCK SEMINAR HALL, VMTW**

ORGANIZED BY:

**DEPARTMENT OF ELECTRONICS AND  
COMMUNICATION ENGINEERING**







# VIGNAN'S INSTITUTE OF MANAGEMENT AND TECHNOLOGY FOR WOMEN

Sponsored by Lavu Educational Society, Approved by AICTE, New Delhi & Affiliated to JNTUH, Hyderabad.  
Kondapur (V), Ghatkesar (M), Medchal - Malkajgiri (D) - 501 301 Phone: +91 98529 10002/3



## DEPARTMENT OF ELECTRONICS AND COMMUNICATION ENGINEERING

ADD ON COURSE NAME: **Design of Smart Antenna Systems and Its Importance**

DAY WISE SCHEDULE SHEET

Academic Year : 2021-2022

Date : 11-09-2021

B.Tech IV-I SEM

SECTION : ECE-A & B

Room number: BFF5

S.No	DAY	Topic	Timings	Duration
1.	17-09-21	Antenna Theory: Antennas	04:00pm to 05:00pm	1 hour
2.	18-09-21	Radiation concept	04:00pm to 05:00pm	1 hour
3.	20-09-21	Types of Antennas	04:00pm to 05:00pm	1 hour
4.	21-09-21	Antenna parameters	04:00pm to 05:00pm	1 hour
5.	22-09-21	Friis Transmission equation	04:00pm to 05:00pm	1 hour
6.	23-09-21	Aperture Antenna: Introduction	04:00pm to 05:00pm	1 hour
7.	24-09-21	Pyramidal Horns- Design Procedure	04:00pm to 05:00pm	1 hour
8.	25-09-21	Conical and Corrugated Horns	04:00pm TO 05:00pm	1 hour
9.	27-09-21	Aperture Corrugated Horns	04:00pm to 05:00pm	1 hour
10.	28-09-21	Reflected Antennas- Parameters	04:00pm to 05:00pm	1 hour
11.	29-09-21	Analysis of front-fed parabolic reflector	04:00pm to 05:00pm	1 hour
12.	30-09-21	Feed methods and feed types	04:00pm to 05:00pm	1 hour
13.	01-10-21	Cassegrain Reflector	04:00pm to 05:00pm	1 hour
14.	04-10-21	Microstrip Radiators: Introduction	04:00pm to 05:00pm	1 hour
15.	05-10-21	Rectangular Microstrip	04:00pm to 05:00pm	1 hour
16.	06-10-21	Antenna analysis and Design	04:00pm to 05:00pm	1 hour
17.	07-10-21	Circular Micro strip Antenna Analysis and Design	04:00pm to 05:00pm	1 hour
18.	08-10-21	Microstrip Slot Antennas: Wave guide fed slots	04:00pm to 05:00pm	1 hour
19.	18-10-21	Radiation mechanism	04:00pm to 05:00pm	1 hour
20.	19-10-21	Micro strip slot antennas	04:00pm to 05:00pm	1 hour
21.	20-10-21	Introduction to rectangular slot	04:00pm to 05:00pm	1 hour



*Principal*  
Vignans Institute of Management & Technology For Women  
Kondapur(V), Ghatkesar(M), Medchal-Malkajgiri(D)-501301  
Telangana State

22.	21-10-21	Narrow, wide, tapered and circularly polarized slot antennas	04:00pm to 05:00pm	1 hour
23.	22-10-21	Annular slot antennas	04:00pm to 05:00pm	1 hour
24.	23-10-21	Comparison of microstrip slot	04:00pm to 05:00pm	1 hour
25.	25-10-21	Arrays Introduction	04:00pm to 05:00pm	1 hour
26.	26-10-21	Micro strip array antennas, Characteristics of fixed beam linear antenna arrays	04:00pm to 05:00pm	1 hour
27.	27-10-21	Linear micro strip arrays	04:00pm to 05:00pm	1 hour
28.	28-10-21	Characteristics of planar arrays	04:00pm to 05:00pm	1 hour
29.	29-10-21	Microstrip planar arrays	04:00pm to 05:00pm	1 hour
30.	30-10-21	Characteristics of planar arrays	04:00pm to 05:00pm	1 hour
31.	01-11-21	Microstrip planar arrays	04:00pm to 05:00pm	1 hour
32.	02-11-21	Test Conducted and Feedback Form	04:00pm to 05:00pm	1 hour
<b>Total – 32 hours</b>				

  
COORDINATOR

  
HOD

Head of the Department  
Electronics and Communication Engineering  
Vignee's Institute of Management and Technology For Women  
Kondapur (V), Ghatkesar (M), R.R. Dist-501 301



  
PRINCIPAL  
Vignee's Institute of Management & Technology For Women  
Kondapur(V), Ghatkesar(M), Medchal-Malkajgiri(Dt)-501301  
Telangana State



# VIGNAN'S INSTITUTE OF MANAGEMENT AND TECHNOLOGY FOR WOMEN

Sponsored by Lavu Educational Society, Approved by AICTE, New Delhi & Affiliated to JNTUH, Hyderabad.  
Kondapur (V), Ghatkesar (M), Medchal - Malkajgiri (D) - 501 301 Phone: +91 96529 10002/3



## DEPARTMENT OF ELECTRONICS AND COMMUNICATION ENGINEERING

ADD ON COURSE NAME: Design of Smart Antenna Systems and Its Importance

ADDON COURSE STUDENT REGISTRATION FORM

Academic Year : 2021-2022

Date : 11-09-2021

B.Tech III-I SEM

SECTION : ECE-A

S.No	Roll Number	Name of the Student	Signature
1	19UPIA0401	ARKALA SNEHA REDDY	Sneha
2	19UPIA0402	BANDI RASAGNA	Rasagna
3	19UPIA0403	BASWA VIGNATHA	Vignatha
4	19UPIA0404	BELLI PAVANI	Pavani
5	19UPIA0405	B V SHIVA KEERTHIKA	Keerthika
6	19UPIA0406	DIWAKARLA SAI LAKSHMI SRAYYA	S. Srayya
7	19UPIA0407	GAJULA ABHIGNA	G. abhi
8	19UPIA0408	GADDAM LIKHITHA	Likhitha
9	19UPIA0409	GIRUGUBOTHALA SAI DEEPTHI	Deepti
10	19UPIA0410	GOLLA PRIYANKA	Priyanka
11	19UPIA0411	GOURISHETTI SWETHA	Swetha
12	19UPIA0412	KOPPELA NISHITHA	Nishitha
13	19UPIA0413	KALAVA CHARITHA	Charitha
14	19UPIA0414	KALVA MAHATHEE REDDY	Mahathee
15	19UPIA0415	KANDE LAHARI	K. Lahari
16	19UPIA0416	KANDULA MEGHANA	Meghana
17	19UPIA0417	KONAKANCHI TEJASWINI	Tejaswini
18	19UPIA0418	KUNCHETTI PRAVALIKA	Pravalika
19	19UPIA0419	LINGAMPALLY ABHINAYA	Abhinaya
20	19UPIA0420	MANNE SRAVANI	Sravani
21	19UPIA0421	NAKKA LAVANYA	Lavanya
22	19UPIA0422	NEELAM MOHANA PRIYA	Priya
23	19UPIA0423	PUSHADAPU LAVANYA	Lavanya
24	19UPIA0424	PALLE PAVANI	Pavani
25	19UPIA0425	PARIMI PRASANNA LAXMI	Prasanna
26	19UPIA0426	P SINDHU	Sindhu P
27	19UPIA0427	RAJPUTH MAHESHWARI SINGH	Mahi
28	19UPIA0428	ROWTHU PALLAVI	Pallavi
29	19UPIA0429	SYED TABASSUM	Tabassum
30	19UPIA0430	SAKSHI JAYASREE BHAVANI	Jaysree
31	19UPIA0431	SANGOJU SATHWIKA	Sathwika
32	19UPIA0432	SEETHAMMAGARI ANITHA	Anitha
33	19UPIA0433	SIVVA AKSHAYA	Akshaya
34	19UPIA0434	SRIPADA JITYA LAKSHMI YESASWINI	Jitya
35	19UPIA0435	SUGGUNA LIKHITA	Likhita
36	19UPIA0436	TANKALA HARIKA	Harika



*[Signature]*  
PRINCIPAL

Vignans Institute of Management & Technology For Women  
Kondapur(V), Ghatkesar(M), Medchal-Malkajgiri(D)-501301  
Telangana State

37	19UP1A0437	THOOMU SREYA REDDY	Sreya
38	19UP1A0438	UPPULA SHUVALEELA	
39	19UP1A0439	VANAM ASHVITHA REDDY	V. Ashvitha
40	19UP1A0440	VANKUDOTH SANGITHA	V. Sangitha
41	19UP1A0441	V LAXMI VASUNDHARA	Vasundhara
42	19UP1A0442	YARASURI GAYATHRI MANASA	Manasa
43	20UP5A0401	AKKI PRATHIMA BHARATHI	Bharathi
44	20UP5A0402	EDUGU RAJITHA	
45	20UP5A0403	GODAVARTHI ANUSHA	Anusha
46	20UP5A0404	GOKA ANUSHA	Anusha
47	20UP5A0405	GOPI VARSHA	Varsha
48	20UP5A0406	JUPALLY NAVYA SRI	
49	20UP5A0407	KOLA CHETHANA	Chethana
50	20UP5A0408	KOTTHUR DEVI	
51	20UP5A0409	MUPPANENI SOWMIKA	Sowmiika

  
COORDINATOR

  
HOD

Head of the Department  
Electronics and Communication Engineering  
Vignan's Institute of Management and Technology For Women  
Kondapur (V), Ghatkesar (M), Medchal-Malkajgiri (D)-501301



  
PRINCIPAL

Vignan's Institute of Management & Technology For Women  
Kondapur(V),Ghatkesar(M),Medchal-Malkajgiri(D)-501301  
Telangana State



# VIGNAN'S INSTITUTE OF MANAGEMENT AND TECHNOLOGY FOR WOMEN

Sponsored by Lavu Educational Society, Approved by AICTE, New Delhi & Affiliated to JNTUH, Hyderabad.  
Kondapur (V), Ghatkesar (M), Medchal - Malkajgiri (D) - 501 301 Phone: +91 96529 10002/3



## DEPARTMENT OF ELECTRONICS AND COMMUNICATION ENGINEERING

ADD ON COURSE NAME: Design of Smart Antenna Systems and Its Importance

ADDON COURSE STUDENT REGISTERED LIST

Academic Year : 2021-2022

Date : 11-09-2021

B.Tech III-I SEM

SECTION : ECE-A

S.No	Roll Number	Name of the Student
1	19UPIA0401	ARKALA SNEHA REDDY
2	19UPIA0402	BANDI RASAGNA
3	19UPIA0403	BASWA VIGNATHA
4	19UPIA0404	BELLI PAVANI
5	19UPIA0405	B V SHIVA KEERTHIKA
6	19UPIA0406	DIWAKARLA SAI LAKSHMI SRAVYA
7	19UPIA0407	GAJULA ABHIGNA
8	19UPIA0409	GIRUGUBOTHALA SAI DEEPTHI
9	19UPIA0410	GOLLA PRIYANKA
10	19UPIA0411	GOURISHETTI SWETHA
11	19UPIA0412	KOPPELA NISHITHA
12	19UPIA0413	KALAYA CHARITHA
13	19UPIA0414	KALVA MAHATHEE REDDY
14	19UPIA0415	KANDE LAHARI
15	19UPIA0416	KANDULA MEGHANA
16	19UPIA0417	KONAKANCHI TEJASWINI
17	19UPIA0418	KUNCHETTI PRAVALIKA
18	19UPIA0419	LINGAMPALLY ABHINAYA
19	19UPIA0421	NAKKA LAVANYA
20	19UPIA0422	NEELAM MOHANA PRIYA
21	19UPIA0423	PUSHADAPU LAVANYA
22	19UPIA0424	PALLE PAVANI
23	19UPIA0425	PARIMI PRASANNA LAXMI
24	19UPIA0426	P SINDHU
25	19UPIA0427	RAJPUTH MAHESHWARI SINGH
26	19UPIA0429	SYED TABASSUM
27	19UPIA0430	SAKSHI JAYASREE BHAVANI
28	19UPIA0431	SANGOJU SATHWIKA
29	19UPIA0432	SEETHAMMAGARI ANITHA
30	19UPIA0433	SIVVA AKSHAYA
31	19UPIA0434	SRIPADA JITYA LAKSHMI YESASWINI
32	19UPIA0435	SUGGUNA LIKHITA
33	19UPIA0436	TANKALA HARIKA
34	19UPIA0437	THOOMU SREYA REDDY
35	19UPIA0439	VANAM ASHVITHA REDDY
36	19UPIA0440	VANKUDOTH SANGITHA



*(Signature)*  
PRINCIPAL

Vignans Institute of Management & Technology for Women  
Kondapur(V), Ghatkesar(M), Medchal-Malkajgiri(D)-501301  
Telangana State

37	19UP1A0441	V LAXMI VASUNDHARA
38	19UP1A0442	YARASURI GAYATHRI MANASA
39	20UP5A0401	AKKI PRATHIMA BHARATHI
40	20UP5A0403	GODAVARTHI ANUSHA
41	20UP5A0404	GOKA ANUSHA
42	20UP5A0405	GOPI VARSHA
43	20UP5A0406	JUPALLY NAVYA SRI
44	20UP5A0407	KOLA CHETHANA
45	20UP5A0409	MUPPANI SOWMIKA

  
COORDINATOR

  
HOD

Head of the Department of  
Electronics and Communication Engineering  
Vignana's Institute of Management & Technology  
Kondapur (V), Ghatkesar (M), Medchal-Malkajgiri (D),  
Telangana State



  
PRINCIPAL  
Vignana's Institute of Management & Technology For Women  
Kondapur(V),Ghatkesar(M),Medchal-Malkajgiri(D)-501301  
Telangana State



# VIGNAN'S INSTITUTE OF MANAGEMENT AND TECHNOLOGY FOR WOMEN

Sponsored by Lawu Educational Society, Approved by AICTE, New Delhi & Affiliated to JNTUH, Hyderabad.  
Kondapur (V), Ghatkesar (M), Medchal - Malkajgiri (D) - 501 301 Phone: +91 98529 10002/3



## DEPARTMENT OF ELECTRONICS AND COMMUNICATION ENGINEERING

ADD ON COURSE NAME: Design of Smart Antenna Systems and Its Impotance

ADDON COURSE STUDENT REGISTRATION FORM

Academic Year : 2021-2022

Date : 11-09-2021

B.Tech III-I SEM

SECTION : ECE-B

S.No	Roll Number	Name of the Student	Signature
1	19UP1A0443	ANNU PRAGATHI	Pragathi
2	19UP1A0444	ANUMOJU KAVYA	Kavya
3	19UP1A0446	BANALA SNITHIKA	Snithika
4	19UP1A0447	BHIMAVARAPU SIVA NAGA SAI SARANYA	Saranya
5	19UP1A0448	BOGALA ANUSHA	Anusha
6	19UP1A0449	BOKKA HARSHITHA	Harshitha
7	19UP1A0450	BOKKA VARSHITHA	Varshitha
8	19UP1A0451	BOLLEPALLY JASHANVI	Jashanvi
9	19UP1A0452	CHIMATA MADHAVI	Madhavi
10	19UP1A0453	DASI VENKATA SAHITHAYA	Sahithaya
11	19UP1A0454	DUGYALA VAISHNAVI	Vaishnavi
12	19UP1A0455	G.SHIRISHA	Shirisha
13	19UP1A0456	GABALE NISHITHA	Nishitha
14	19UP1A0457	GOURISHETTI HARSHA VARDHINI	Harsha
15	19UP1A0458	GUMAMALA SNEHA REDDY	Sneha
16	19UP1A0459	HALDODDI DIVYA	Divya
17	19UP1A0460	JANJIRALA ANUSHA	Anusha
18	19UP1A0461	KARKURI SOWMYA	Sowmya
19	19UP1A0462	KALYANAM MOUNIKA	Mounika
20	19UP1A0463	KOMMINENI JASMITHA	Jasmin
21	19UP1A0464	KONDERU SRAVYA	Sravya
22	19UP1A0465	LAKAMGARI PRASANNA LAXMI REDDY	Prasanna
23	19UP1A0466	GADDAM LIKHITHA	Likhitha
24	19UP1A0467	LIMBURE SANTHOSHI	Santhoshi
25	19UP1A0468	MALGIREDDY YOGITHA REDDY	Yogitha
26	19UP1A0469	MARVALA DEEPIKA	Deepika
27	19UP1A0470	MEDA BHUVANESWARI	Bhuvaneshwari
28	19UP1A0471	PADAKULA UMA	Uma
29	19UP1A0472	RAMIDI DEEKSHITHA	Deekshitha
30	19UP1A0473	RAVULA HIRANMAI	Hiranmai
31	19UP1A0474	SHANIGALA CHANDANA	Chandana



  
PRINCIPAL

Vignans Institute of Management & Technology For Women  
Kondapur(V), Ghatkesar(M), Medchal-Malkajgiri(D)-501301  
Telangana State

32	19UPIA0475	MORAPALLY SIRI CHANDANA REDDY	Chandana
33	19UPIA0476	SUROJU SRIVAISHNAVI	Vaishnavi
34	19UPIA0477	TELUKUNTLA SREYA REDDY	Sreya
35	19UPIA0478	THAMATAM AKSHITHA	Akshitha
36	19UPIA0479	TURPU SHRAVANI	Shravani
37	19UPIA0480	VANGETI BANNY	-
38	19UPIA0481	VENNAMANENI ANOUSHIKA	Anoushika
39	19UPIA0482	YEDULLA NAGALAXMI	Naga.
40	20UP5A0410	NAGARAM ANUSHA	Anusha
41	20UP5A0411	NAKKA YAMINI	Yamini
42	20UP5A0412	NATTUVA BHARGAVI	bhargavi
43	20UP5A0413	PALASA CHANDANA	chandana
44	20UP5A0414	SANKURI SRAVANI	Sravani
45	20UP5A0415	T ANUSHA	Anusha
46	20UP5A0416	VADDABOINA NAMRATHA	Namratha
47	20UP5A0417	VADLA SHIVANI	-
48	20UP5A0418	VINDHYA DARSHINI	Indya
49	20UP5A0419	YAMJALA SHAMILI	Y. Shamili

  
COORDINATOR

  
HOD

Head of the Department  
Electronics and Communication Engineering  
Vignana Institute of Management & Technology For Women  
Kondapur (V), Ghatkesar (M), Medchal-Malkajgiri (D), TS-501301



  
PRINCIPAL  
Vignana Institute of Management & Technology For Women  
Kondapur(V), Ghatkesar(M), Medchal-Malkajgiri(D)-501301  
Telangana State





# VIGNAN'S INSTITUTE OF MANAGEMENT AND TECHNOLOGY FOR WOMEN

Sponsored by Lavu Educational Society, Approved by AICTE, New Delhi & Affiliated to JNTUH, Hyderabad.  
Kondapur (V), Ghatkesar (M), Medchal - Malkajgiri (D) - 501 301 Phone: +91 96529 10002/3



## DEPARTMENT OF ELECTRONICS AND COMMUNICATION ENGINEERING

ADD ON COURSE NAME: Design of Smart Antenna Systems and Its Importance

### ADDON COURSE STUDENT REGISTERED LIST

Academic Year : 2021-2022

Date : 11-09-2021

B.Tech III-I SEM

SECTION : ECE-B

S.No	Roll Number	Name of the Student
1	19UPIA0443	ANNU PRAGATHI
2	19UPIA0444	ANUMOJU KAVYA
3	19UPIA0446	BANALA SNITHIKA
4	19UPIA0447	BHIMAVARAPU SIVA NAGA SAI SARANYA
5	19UPIA0448	BOGALA ANUSHA
6	19UPIA0450	BOKKA VARSHITHA
7	19UPIA0451	BOLLEPALLY JASHANVI
8	19UPIA0452	CHIMATA MADHAVI
9	19UPIA0453	DASI VENKATA SAHITHAYA
10	19UPIA0454	DUGYALA VAISHNAVI
11	19UPIA0455	G.SHIRISHA
12	19UPIA0456	GABALE NISHITHA
13	19UPIA0457	GOURISHETTI HARSHA VARDHINI
14	19UPIA0458	GUMAMALA SNEHA REDDY
15	19UPIA0459	HALDODDI DIVYA
16	19UPIA0460	JANJIRALA ANUSHA
17	19UPIA0461	KARKURI SOWMYA
18	19UPIA0463	KOMMINENT JASMITHA
19	19UPIA0464	KONDERU SRAVYA
20	19UPIA0465	LAKAMGARI PRASANNA LAXMI REDDY
21	19UPIA0466	GADDAM LIKHITHA
22	19UPIA0467	LIMBURE SANTHOSHI
23	19UPIA0468	MALGIREDDY YOGITHA REDDY
24	19UPIA0469	MARVALA DEEPIKA
25	19UPIA0470	MEDA BHUVANESWARI
26	19UPIA0471	PADAKULA UMA
27	19UPIA0472	RAMIDI DEEKSHITHA
28	19UPIA0473	RAVULA HIRANMAI
29	19UPIA0474	SHANIGALA CHANDANA
30	19UPIA0475	MORAPALLY SIRI CHANDANA REDDY
31	19UPIA0476	SUROJU SRIVAISHNAVI
32	19UPIA0477	TELUKUNTLA SREYA REDDY
33	19UPIA0478	THAMATAM AKSHITHA
34	19UPIA0479	TURPU SHRAVANI
35	19UPIA0481	VENNAMANANI ANOUSHIKA
36	19UPIA0482	YEDULLA NAGALAXMI
37	20UP5A0410	NAGARAM ANUSHA



*Vignans*  
PRINCIPAL  
Vignans Institute of Management & Technology For Women,  
Kondapur (V), Ghatkesar (M), Medchal - Malkajgiri (D) - 501301  
Telangana State

38	20UP5A0411	NAKKA YAMINI
39	20UP5A0412	NATTUVA BHARGAVI
40	20UP5A0413	PALASA CHANDANA
41	20UP5A0414	SANKURI SRAVANI
42	20UP5A0415	T ANUSHA
43	20UP5A0416	VADDABOINA NAMRATHA
44	20UP5A0418	VINDHYA DARSHINI
45	20UP5A0419	YAMJALA SHAMILI

  
**COORDINATOR**

  
**HOD**

Head of the Department  
 Electronics and Communication Engg  
 Vignn's Institute of Management & Technology For Women  
 Kondapur (V), Ghatkesar (M), Medchal-Malkajgiri (Dt)



  
**PRINCIPAL**  
 Vignn's Institute of Management & Technology For Women  
 Kondapur(V), Ghatkesar(M), Medchal-Malkajgiri(Dt)-501301  
 Telangana State



# VIGNAN'S INSTITUTE OF MANAGEMENT AND TECHNOLOGY FOR WOMEN

Sponsored by Lavu Educational Society, Approved by AICTE, New Delhi & Affiliated to JNTUH, Hyderabad.  
Kondapur (V), Ghatkesar (M), Medchal - Malkajgiri (D) - 501 301 Phone: +91 96529 10002/3



## DEPARTMENT OF ELECTRONICS AND COMMUNICATION ENGINEERING

ADD ON COURSE NAME: Design of Smart Antenna Systems and Its Importance

DAY WISE ATTENDANCE SHEET

Academic Year : 2021-2022

Date : 17-09-2021

B.Tech III-I SEM

SECTION : ECE-A

S.No	Roll Number	17-09-21	18-09-21	20-09-21	21-09-21	22-09-21
1	19UPIA0401	<del>Smita</del>	<del>Smita</del>	<del>Smita</del>	<del>Smita</del>	<del>Smita</del>
2	19UPIA0402	Rasagna	Rasagna	Rasagna	Rasagna	Rasagna
3	19UPIA0403	Vignadha	Vignadha	Vignadha	Vignadha	Vignadha
4	19UPIA0404	Pavani	Pavani	Pavani	Pavani	Pavani
5	19UPIA0405	Keerthi	Keerthi	Keerthi	Keerthi	Keerthi
6	19UPIA0406	D. Sravya	D. Sravya	D. Sravya	D. Sravya	D. Sravya
7	19UPIA0407	G. abhi	G. abhi	G. abhi	G. abhi	G. abhi
8	19UPIA0409	deepthi	deepthi	deepthi	deepthi	deepthi
9	19UPIA0410	Vy	Vy	Vy	Vy	Vy
10	19UPIA0411	G. Swetha	G. Swetha	G. Swetha	G. Swetha	G. Swetha
11	19UPIA0412	Nishitha	Nishitha	Nishitha	Nishitha	Nishitha
12	19UPIA0413	Charitha	Charitha	Charitha	Charitha	Charitha
13	19UPIA0414	Maahat	Maahat	Maahat	Maahat	Maahat
14	19UPIA0415	K. Lahari	K. Lahari	K. Lahari	K. Lahari	K. Lahari
15	19UPIA0416	Meghana	Meghana	Meghana	Meghana	Meghana
16	19UPIA0417	Tejaswini	Tejaswini	Tejaswini	Tejaswini	Tejaswini
17	19UPIA0418	pravalika	pravalika	AB	pravalika	pravalika
18	19UPIA0419	L. Abhinaya	L. Abhinaya	Abhinaya	L. Abhinaya	L. Abhinaya
19	19UPIA0421	Lavanya	Lavanya	Lavanya	Lavanya	Lavanya
20	19UPIA0422	Priya	Priya	Priya	Priya	Priya
21	19UPIA0423	Lavanya	Lavanya	Lavanya	Lavanya	Lavanya
22	19UPIA0424	Pavani	Pavani	Pavani	Pavani	Pavani
23	19UPIA0425	Prasanna	Prasanna	Prasanna	Prasanna	Prasanna
24	19UPIA0426	sindhu P	sindhu P	sindhu P	sindhu P	sindhu P
25	19UPIA0427	Mahi	Mahi	Mahi	Mahi	Mahi
26	19UPIA0429	G	G	G	G	G
27	19UPIA0430	Gaya	Gaya	Gaya	Gaya	Gaya
28	19UPIA0431	sathwika	sathwika	sathwika	sathwika	sathwika
29	19UPIA0432	Anitha	Anitha	Anitha	Anitha	Anitha
30	19UPIA0433	Akshaya	Akshaya	Akshaya	Akshaya	Akshaya
31	19UPIA0434	Likhita	Likhita	Likhita	Likhita	Likhita
32	19UPIA0435	Likhita	Likhita	Likhita	Likhita	Likhita



*[Signature]*  
PRINCIPAL

Vignan's Institute of Management & Technology For Women  
Kondapur(V), Ghatkesar(M), Medchal-Malkajgiri(D)-501301  
Telangana State

33	19UP1A0436	<del>Harsh</del>	<del>Harsh</del>	<del>Harsh</del>	<del>Harsh</del>	<del>Harsh</del>
34	19UP1A0437	Geeta	Geeta	Geeta	Geeta	Geeta
35	19UP1A0439	V. Ashvitha	V. Ashvitha	V. Ashvitha	V. Ashvitha	V. Ashvitha
36	19UP1A0440	V. Sangitha	V. Sangitha	V. Sangitha	V. Sangitha	V. Sangitha
37	19UP1A0441	Vasundhara	Vasundhara	Vasundhara	Vasundhara	Vasundhara
38	19UP1A0442	Manasa	AB	Manasa	Manasa	Manasa
39	20UP5A0401	Bharathi	Bharathi	Bharathi	Bharathi	Bharathi
40	20UP5A0403	Anusha	Anusha	Anusha	Anusha	Anusha
41	20UP5A0404	Anusha	Anusha	Anusha	Anusha	Anusha
42	20UP5A0405	Vaisha	Vaisha	Vaisha	Vaisha	Vaisha
43	20UP5A0406	Chethana	Chethana	Chethana	Chethana	Chethana
44	20UP5A0407	Chethana	Chethana	Chethana	Chethana	Chethana
45	20UP5A0409	Saumika	Saumika	Saumika	Saumika	Saumika

  
COORDINATOR

  
HOD

Head of the Department  
Electronics and Communication Engineering  
Vignans Institute of Management & Technology For Women  
Kondapur (V), Ghatkesar (M), Medchal-Malkajgiri (Dt) - 501301



  
PRINCIPAL  
Vignans Institute of Management & Technology For Women  
Kondapur(V), Ghatkesar(M), Medchal-Malkajgiri(Dt)-501301  
Telangana State



# VIGNAN'S INSTITUTE OF MANAGEMENT AND TECHNOLOGY FOR WOMEN

Sponsored by Laxmi Educational Society, Approved by AICTE, New Delhi & Affiliated to JNTUH, Hyderabad.  
Kondapur (V), Ghatkesar (M), Medchal - Malkajgiri (D) - 501 301 Phone: +91 98529 10002/3



## DEPARTMENT OF ELECTRONICS AND COMMUNICATION ENGINEERING

ADD ON COURSE NAME: **Design of Smart Antenna Systems and Its Importance**

DAY WISE ATTENDANCE SHEET

Academic Year : 2021-2022

Date : 17-09-2021

B.Tech III-I SEM

SECTION : ECE-B

S.No	Roll Number	17-09-21	18-09-21	20-09-21	21-09-21	22-09-21
1	19UPIA0443	Kavya	Kavya	Kavya	Kavya	Kavya
2	19UPIA0444	Prati	Prati	Prati	Prati	Prati
3	19UPIA0446	Smita	Smita	Smita	Smita	Smita
4	19UPIA0447	Saranyal	Saranyal	Saranyal	Saranyal	Saranyal
5	19UPIA0448	Anusha	Anusha	Anusha	Anusha	Anusha
6	19UPIA0450	Varsh	Varsh	Varsh	Varsh	Varsh
7	19UPIA0451	Jashanti	Jashanti	Jashanti	Jashanti	Jashanti
8	19UPIA0452	Madhavi	Madhavi	Madhavi	Madhavi	Madhavi
9	19UPIA0453	Sahithaya	Sahithaya	Sahithaya	Sahithaya	Sahithaya
10	19UPIA0454	Vaishnavi	Vaishnavi	Vaishnavi	Vaishnavi	Vaishnavi
11	19UPIA0455	Sirisha	Sirisha	Sirisha	Sirisha	Sirisha
12	19UPIA0456	Nisha	Nisha	Nisha	Nisha	Nisha
13	19UPIA0457	Karsha	Karsha	Karsha	Karsha	Karsha
14	19UPIA0458	Sneha	Sneha	Sneha	Sneha	Sneha
15	19UPIA0459	Durga	Durga	Durga	Durga	Durga
16	19UPIA0460	Jashanti	Jashanti	Jashanti	Jashanti	Jashanti
17	19UPIA0461	Soumya	Soumya	Soumya	Soumya	Soumya
18	19UPIA0463	Jashanti	Jashanti	Jashanti	Jashanti	Jashanti
19	19UPIA0464	Jashanti	Jashanti	Jashanti	Jashanti	Jashanti
20	19UPIA0465	Prasanna	Prasanna	Prasanna	Prasanna	Prasanna
21	19UPIA0466	Likitha	AB	Likitha	Likitha	Likitha
22	19UPIA0467	Santhi	Santhi	Santhi	Santhi	Santhi
23	19UPIA0468	Yujitha	Yujitha	Yujitha	Yujitha	Yujitha
24	19UPIA0469	Deepika	Deepika	Deepika	Deepika	Deepika
25	19UPIA0470	Bhuvaneshwari	Bhuvaneshwari	Bhuvaneshwari	Bhuvaneshwari	Bhuvaneshwari
26	19UPIA0471	Uma	Uma	Uma	Uma	Uma
27	19UPIA0472	Deekshitha	Deekshitha	Deekshitha	Deekshitha	Deekshitha
28	19UPIA0473	Hiranmayi	Hiranmayi	Hiranmayi	Hiranmayi	Hiranmayi
29	19UPIA0474	Chandana	Chandana	Chandana	Chandana	Chandana
30	19UPIA0475	Chandana	Chandana	Chandana	Chandana	Chandana
31	19UPIA0476	Vaishnavi	Vaishnavi	Vaishnavi	Vaishnavi	Vaishnavi
32	19UPIA0477	Kavya	Kavya	Kavya	Kavya	Kavya



*[Signature]*  
PRINCIPAL

Vignans Institute of Management & Technology For Women  
Kondapur(V), Ghatkesar(M), Medchal-Malkajgiri(D)-501301  
Telangana State

33	19UP1A0478	Akshitha	Akshitha	Akshitha	Akshitha	Akshitha
34	19UP1A0479	Shravani	shravani	Shravani	Shravani	Shravani
35	19UP1A0481	Anand	Anand	Anand	Anand	Anand
36	19UP1A0482	Naga	Naga	Naga	Naga	Naga
37	20UP5A0410	Anu	Anu	Anu	Anu	Anu
38	20UP5A0411	Yamini	Yamini	Yamini	Yamini	Yamini
39	20UP5A0412	bhargavi	bhargavi	bhargavi	bhargavi	bhargavi
40	20UP5A0413	chandu	chandu	AB	chandu	chandu
41	20UP5A0414	Sravani	Sravani	Sravani	Sravani	Sravani
42	20UP5A0415	Anusha	Anusha	Anusha	Anusha	Anusha
43	20UP5A0416	namrata	namrata	namrata	namrata	namrata
44	20UP5A0418	Anu	Anu	Anu	Anu	Anu
45	20UP5A0419	Y.Shamili	Y.Shamili	Y.Shamili	Y.Shamili	Y.Shamili

  
COORDINATOR

  
HOD

Head of the Department  
Electronics and Communication Engineering  
Vignans Institute of Management & Technology For Women  
Medchal-Malkajgiri (Dt) - 501301  
Telangana State



  
PRINCIPAL  
Vignans Institute of Management & Technology For Women  
Kondapur(V), Ghatkesar(M), Medchal-Malkajgiri(Dt)-501301  
Telangana State



# VIGNAN'S INSTITUTE OF MANAGEMENT AND TECHNOLOGY FOR WOMEN

Sponsored by Law Educational Society, Approved by AICTE, New Delhi & Affiliated to JNTUH, Hyderabad.  
Kondapur (V), Ghatkesar (M), Medchal - Malkajgiri (D) - 501 301 Phone: +91 96529 10002/3



## DEPARTMENT OF ELECTRONICS AND COMMUNICATION ENGINEERING

ADD ON COURSE NAME: Design of Smart Antenna Systems and Its Importance

DAY WISE ATTENDANCE SHEET

Academic Year : 2021-2022

Date : 23-09-2021

B.Tech III-I SEM

SECTION : ECE-A

S.No	Roll Number	23-09-21	24-09-21	25-09-21	27-09-21	28-09-21
1	19UPIA0401	<del>sunitha</del>	<del>sunitha</del>	<del>sunitha</del>	<del>sunitha</del>	<del>sunitha</del>
2	19UPIA0402	Rasagna	Rasagna	Rasagna	Rasagna	Rasagna
3	19UPIA0403	Vignadha	Vignadha	Vignadha	Vignadha	Vignadha
4	19UPIA0404	Pavani	Pavani	Pavani	Pavani	Pavani
5	19UPIA0405	Keerthi	Keerthi	Keerthi	Keerthi	Keerthi
6	19UPIA0406	D. Sravya	D. Sravya	D. Sravya	D. Sravya	D. Sravya
7	19UPIA0407	AP	G. abhi	G. abhi	G. abhi	G. abhi
8	19UPIA0409	deepthi	deepthi	deepthi	deepthi	deepthi
9	19UPIA0410	W	W	W	W	W
10	19UPIA0411	G. Sruetha	G. Sruetha	G. Sruetha	G. Sruetha	G. Sruetha
11	19UPIA0412	Nishitha	Nishitha	Nishitha	Nishitha	Nishitha
12	19UPIA0413	Charitha	Charitha	Charitha	Charitha	Charitha
13	19UPIA0414	Mahathal	Mahathal	Mahathal	Mahathal	Mahathal
14	19UPIA0415	K. Lakshmi	K. Lakshmi	K. Lakshmi	K. Lakshmi	K. Lakshmi
15	19UPIA0416	Meghana	Meghana	Meghana	Meghana	Meghana
16	19UPIA0417	Tejaswini	Tejaswini	Tejaswini	Tejaswini	Tejaswini
17	19UPIA0418	Pravalika	Pravalika	Pravalika	Pravalika	Pravalika
18	19UPIA0419	Lakshmi	Lakshmi	Lakshmi	Lakshmi	Lakshmi
19	19UPIA0421	Lavanya	Lavanya	Lavanya	Lavanya	Lavanya
20	19UPIA0422	Priya	Priya	Priya	Priya	Priya
21	19UPIA0423	Lavanya	Lavanya	Lavanya	Lavanya	Lavanya
22	19UPIA0424	Pavani	Pavani	Pavani	Pavani	Pavani
23	19UPIA0425	Prasanna	Prasanna	Prasanna	Prasanna	Prasanna
24	19UPIA0426	sindhu	sindhu	sindhu	sindhu	sindhu
25	19UPIA0427	Mali	Mali	Mali	Mali	Mali
26	19UPIA0429	Lakshmi	Lakshmi	Lakshmi	Lakshmi	Lakshmi
27	19UPIA0430	Lakshmi	Lakshmi	Lakshmi	Lakshmi	Lakshmi
28	19UPIA0431	sathwika	sathwika	sathwika	sathwika	sathwika
29	19UPIA0432	Anitha	Anitha	Anitha	Anitha	Anitha
30	19UPIA0433	Aleshaya	Aleshaya	Aleshaya	Aleshaya	Aleshaya
31	19UPIA0434	Lakshmi	Lakshmi	Lakshmi	Lakshmi	Lakshmi
32	19UPIA0435	Lakshmi	Lakshmi	Lakshmi	Lakshmi	Lakshmi



PRINCIPAL  
Vignani's Institute of Management & Technology For Women  
Kondapur(V), Ghatkesar(M), Medchal-Malkajgiri(D)-501301  
Telangana State

33	19UP1A0436	<del>Hrish</del>	<del>Hrish</del>	<del>Hrish</del>	<del>Hrish</del>	<del>Hrish</del>
34	19UP1A0437	<del>Sreya</del>	<del>Sreya</del>	<del>Sreya</del>	<del>Sreya</del>	<del>Sreya</del>
35	19UP1A0439	<del>V. Ashvitha</del>	<del>V. Ashvitha</del>	<del>V. Ashvitha</del>	<del>V. Ashvitha</del>	<del>V. Ashvitha</del>
36	19UP1A0440	<del>V. Sangitha</del>	<del>V. Sangitha</del>	<del>V. Sangitha</del>	<del>V. Sangitha</del>	<del>V. Sangitha</del>
37	19UP1A0441	<del>vasundhara</del>	<del>vasundhara</del>	<del>vasundhara</del>	<del>vasundhara</del>	<del>vasundhara</del>
38	19UP1A0442	<del>Manasa</del>	<del>Manasa</del>	<del>Manasa</del>	<del>Manasa</del>	<del>Manasa</del>
39	20UP5A0401	<del>Bharathi</del>	<del>Bharathi</del>	<del>Bharathi</del>	<del>Bharathi</del>	<del>Bharathi</del>
40	20UP5A0403	<del>Anusha</del>	<del>Anusha</del>	<del>Anusha</del>	<del>Anusha</del>	<del>Anusha</del>
41	20UP5A0404	<del>Anusha</del>	<del>Anusha</del>	<del>Anusha</del>	<del>Anusha</del>	<del>Anusha</del>
42	20UP5A0405	<del>Vasika</del>	<del>Vasika</del>	<del>Vasika</del>	<del>Vasika</del>	<del>Vasika</del>
43	20UP5A0406	<del>Chethana</del>	<del>Chethana</del>	<del>Chethana</del>	<del>Chethana</del>	<del>Chethana</del>
44	20UP5A0407	<del>Chethana</del>	<del>Chethana</del>	<del>Chethana</del>	<del>Chethana</del>	<del>Chethana</del>
45	20UP5A0409	<del>Soumitra</del>	<del>Soumitra</del>	<del>Soumitra</del>	<del>Soumitra</del>	<del>Soumitra</del>

  
COORDINATOR

  
HOD

Head of the Department  
Electronics and Communication Engineering,  
Sri Janaki Institute of Management & Technology For Women  
Kondapur (V), Medchal (M), Medchal-Malkajgiri (D)-501301



  
PRINCIPAL  
Sri Janaki Institute of Management & Technology For Women  
Kondapur (V), Medchal (M), Medchal-Malkajgiri (D)-501301  
Telangana State





# VIGNAN'S INSTITUTE OF MANAGEMENT AND TECHNOLOGY FOR WOMEN

Sponsored by Law Educational Society, Approved by AICTE, New Delhi & Affiliated to JNTUH, Hyderabad.  
Kondapur (V), Ghatkesar (M), Medchal - Malkajgiri (D) - 501 301 Phone: +91 98529 10002/3



## DEPARTMENT OF ELECTRONICS AND COMMUNICATION ENGINEERING

ADD ON COURSE NAME: Design of Smart Antenna Systems and Its Importance

DAY WISE ATTENDANCE SHEET

Academic Year : 2021-2022

Date : 23-09-2021

B.Tech III-I SEM

SECTION : ECE-B

S.No	Roll Number	23-09-21	24-09-21	25-09-21	27-09-21	28-09-21
1	19UP1A0443	Kavya	Kavya	Kavya	Kavya	Kavya
2	19UP1A0444	Pragati	Pragati	Pragati	Pragati	Pragati
3	19UP1A0446	Smriti	Smriti	Smriti	Smriti	Smriti
4	19UP1A0447	Saranya	Saranya	Saranya	Saranya	Saranya
5	19UP1A0448	Anusha	Anusha	Anusha	Anusha	Anusha
6	19UP1A0450	Vaishali	Vaishali	Vaishali	Vaishali	Vaishali
7	19UP1A0451	Jashvi	Jashvi	Jashvi	Jashvi	Jashvi
8	19UP1A0452	Madhavi	Madhavi	Madhavi	Madhavi	Madhavi
9	19UP1A0453	Sahithya	Sahithya	Sahithya	Sahithya	Sahithya
10	19UP1A0454	Vaishnavi	Vaishnavi	Vaishnavi	Vaishnavi	Vaishnavi
11	19UP1A0455	Sirisha	Sirisha	Sirisha	Sirisha	Sirisha
12	19UP1A0456	AB	AB	AB	AB	AB
13	19UP1A0457	Karsha	Karsha	Karsha	Karsha	Karsha
14	19UP1A0458	Sneha	Sneha	Sneha	Sneha	Sneha
15	19UP1A0459	Durga	Durga	Durga	Durga	Durga
16	19UP1A0460	A	A	A	A	A
17	19UP1A0461	Soumya	Soumya	Soumya	Soumya	Soumya
18	19UP1A0463	Jashu	Jashu	Jashu	Jashu	Jashu
19	19UP1A0464	A	A	A	A	A
20	19UP1A0465	Prasanna	Prasanna	Prasanna	Prasanna	Prasanna
21	19UP1A0466	Likitha	Likitha	Likitha	Likitha	Likitha
22	19UP1A0467	Santhi	Santhi	Santhi	Santhi	Santhi
23	19UP1A0468	Hujjith	Hujjith	Hujjith	Hujjith	Hujjith
24	19UP1A0469	Deepika	Deepika	Deepika	Deepika	Deepika
25	19UP1A0470	Bhuvaneshwari	Bhuvaneshwari	Bhuvaneshwari	Bhuvaneshwari	Bhuvaneshwari
26	19UP1A0471	Uma	Uma	Uma	Uma	Uma
27	19UP1A0472	Deekshitha	Deekshitha	Deekshitha	Deekshitha	Deekshitha
28	19UP1A0473	Hirannal	Hirannal	Hirannal	Hirannal	Hirannal
29	19UP1A0474	Chardana	Chardana	Chardana	Chardana	Chardana
30	19UP1A0475	Chardana	Chardana	Chardana	Chardana	Chardana
31	19UP1A0476	Vaishnavi	Vaishnavi	Vaishnavi	Vaishnavi	Vaishnavi
32	19UP1A0477	AB	AB	AB	AB	AB



**PRINCIPAL**

Vignans Institute of Management & Technology For Women  
Kondapur(V), Ghatkesar(M), Medchal - Malkajgiri (D) - 501301  
Telangana State

33	19UP1A0478	Akshitha	Akshitha	Akshitha	Akshitha	Akshitha
34	19UP1A0479	shravani	shravani	Shravani	Shravani	Shravani
35	19UP1A0481	Anjali	Anjali	Anjali	Anjali	Anjali
36	19UP1A0482	Naga	Naga	Naga	Naga	Naga
37	20UP5A0410	Ashu	Ashu	Ashu	Ashu	Ashu
38	20UP5A0411	Yamini	Yamini	Yamini	Yamini	Yamini
39	20UP5A0412	bhargavi	bhargavi	AB	bhargavi	bhargavi
40	20UP5A0413	chandu	chandu	chandu	chandu	chandu
41	20UP5A0414	Sravani	Sravani	Sravani	Sravani	Sravani
42	20UP5A0415	Anusha	Anusha	Anusha	Anusha	Anusha
43	20UP5A0416	narmatha	narmatha	narmatha	narmatha	narmatha
44	20UP5A0418	As	As	As	As	As
45	20UP5A0419	Y. Shamili	Y. Shamili	Y. Shamili	Y. Shamili	Y. Shamili

  
COORDINATOR

  
HOD

Head of the Department  
Electronics and Communication Engineering  
Vignans Institute of Management & Technology (V)  
Kandapur (V), Ghatkesar (M), Medchal-Malkajgiri (D) - 501301



  
PRINCIPAL

Vignans Institute of Management & Technology For Women  
Kandapur(V), Ghatkesar(M), Medchal-Malkajgiri(D)-501301  
Telangana State



# VIGNAN'S INSTITUTE OF MANAGEMENT AND TECHNOLOGY FOR WOMEN

Sponsored by Laxmi Educational Society, Approved by AICTE, New Delhi & Affiliated to JNTUH, Hyderabad.  
Kondapur (V), Ghatkesar (M), Medchal - Malkajgiri (D) - 501 301 Phone: +91 96529 10002/3



## DEPARTMENT OF ELECTRONICS AND COMMUNICATION ENGINEERING

ADD ON COURSE NAME: Design of Smart Antenna Systems and Its Importance

DAY WISE ATTENDANCE SHEET

Academic Year : 2021-2022

Date : 29-09-2021

B.Tech III-I SEM

SECTION : ECE-A

S.No	Roll Number	29-09-21	30-09-21	01-10-21	04-10-21	05-10-21
1	19UPIA0401	<del>subha</del>	<del>subha</del>	<del>subha</del>	<del>subha</del>	<del>subha</del>
2	19UPIA0402	Kasagna	Kasagna	Kasagna	Kasagna	Kasagna
3	19UPIA0403	Vignatha	Vignatha	Vignatha	Vignatha	Vignatha
4	19UPIA0404	Pavani	Pavani	Pavani	Pavani	Pavani
5	19UPIA0405	keerthi	keerthi	keerthi	keerthi	keerthi
6	19UPIA0406	D.sravya	D.sravya	D.sravya	D.sravya	D.sravya
7	19UPIA0407	G.abhi	G.abhi	G.abhi	G.abhi	G.abhi
8	19UPIA0409	deepthi	deepthi	deepthi	deepthi	deepthi
9	19UPIA0410	<del>PI</del>	<del>PI</del>	<del>PI</del>	<del>PI</del>	<del>PI</del>
10	19UPIA0411	G.Swetha	G.Swetha	G.Swetha	G.Swetha	G.Swetha
11	19UPIA0412	Nishitha	Nishitha	Nishitha	Nishitha	Nishitha
12	19UPIA0413	Charitha	Charitha	Charitha	Charitha	Charitha
13	19UPIA0414	Mahathesh	Mahathesh	Mahathesh	Mahathesh	Mahathesh
14	19UPIA0415	K.lakshmi	K.lakshmi	K.lakshmi	K.lakshmi	K.lakshmi
15	19UPIA0416	Meghana	Meghana	Meghana	Meghana	Meghana
16	19UPIA0417	Tejaswini	Tejaswini	Tejaswini	Tejaswini	Tejaswini
17	19UPIA0418	pravalika	pravalika	pravalika	pravalika	pravalika
18	19UPIA0419	L.Abhinaya	L.Abhinaya	L.Abhinaya	L.Abhinaya	L.Abhinaya
19	19UPIA0421	Lavanya	Lavanya	Lavanya	Lavanya	Lavanya
20	19UPIA0422	Priya	Priya	Priya	Priya	Priya
21	19UPIA0423	Lavanya	Lavanya	Lavanya	Lavanya	Lavanya
22	19UPIA0424	Pavani	Pavani	Pavani	Pavani	Pavani
23	19UPIA0425	Prasanna	Prasanna	AR	Prasanna	Prasanna
24	19UPIA0426	sindhur	sindhur	sindhur	sindhur	sindhur
25	19UPIA0427	Mali	Mali	Mali	Mali	Mali
26	19UPIA0429	Ge	Ge	Ge	Ge	Ge
27	19UPIA0430	Gaya	Gaya	Gaya	Gaya	Gaya
28	19UPIA0431	sathwika	sathwika	sathwika	sathwika	sathwika
29	19UPIA0432	Anitha	Anitha	Anitha	Anitha	Anitha
30	19UPIA0433	Ashaya	Ashaya	Ashaya	Ashaya	Ashaya
31	19UPIA0434	Ashaya	Ashaya	Ashaya	Ashaya	Ashaya
32	19UPIA0435	Likhita	Likhita	Likhita	Likhita	Likhita



*AS*  
PRINCIPAL

Vignan's Institute of Management & Technology For Women  
Kondapur(V), Ghatkesar(M), Medchal-Malkajgiri(D)-501301  
Telangana State

33	19UP1A0436	<del>Harsh</del>	<del>Harsh</del>	<del>Harsh</del>	<del>Harsh</del>	<del>Harsh</del>
34	19UP1A0437	Sreya	Sreya	Sreya	Sreya	Sreya
35	19UP1A0439	V. Ashvitha	V. Ashvitha	V. Ashvitha	V. Ashvitha	V. Ashvitha
36	19UP1A0440	V. Sangitha	V. Sangitha	V. Sangitha	V. Sangitha	V. Sangitha
37	19UP1A0441	vasundhara	vasundhara	vasundhara	vasundhara	vasundhara
38	19UP1A0442	Manasa	Manasa	Manasa	Manasa	Manasa
39	20UP5A0401	Bharathi	Bharathi	Bharathi	Bharathi	Bharathi
40	20UP5A0403	Anusha	Anusha	Anusha	Anusha	Anusha
41	20UP5A0404	<del>Anusha</del>	<del>Anusha</del>	<del>Anusha</del>	<del>Anusha</del>	<del>Anusha</del>
42	20UP5A0405	Vashta	Vashta	Vashta	AB	Vashta
43	20UP5A0406	N	N	N	N	N
44	20UP5A0407	Chellam	Chellam	Chellam	Chellam	Chellam
45	20UP5A0409	Saumika	Saumika	Saumika	Saumika	Saumika

  
COORDINATOR

  
HOD

Head of the Department  
Electronic and Communication Engineering  
Vignans Institute of Management & Technology For Women  
Kondapur (V), Ghatkesar (M), Medchal-Malkajgiri (Dist)-501301



  
PRINCIPAL

Vignans Institute of Management & Technology For Women  
Kondapur(V),Ghatkesar(M),Medchal-Malkajgiri(Dist)-501301  
Telangana State



# VIGNAN'S INSTITUTE OF MANAGEMENT AND TECHNOLOGY FOR WOMEN

Sponsored by Law Educational Society, Approved by AICTE, New Delhi & Affiliated to JNTUH, Hyderabad.  
Kondapur (V), Ghatkesar (M), Medchal - Malkajgiri (D) - 501 301 Phone: +91 96529 10002/3



## DEPARTMENT OF ELECTRONICS AND COMMUNICATION ENGINEERING

ADD ON COURSE NAME: Design of Smart Antenna Systems and Its Importance

DAY WISE ATTENDANCE SHEET

Academic Year : 2021-2022

Date : 29-09-2021

B.Tech III-I SEM

SECTION : ECE-B

S.No	Roll Number	29-09-21	30-09-21	01-10-21	04-10-21	05-10-21
1	19UPIA0443	Kavya	Kavya	Kavya	Kavya	Kavya
2	19UPIA0444	Prati	Prati	Prati	Prati	Prati
3	19UPIA0446	Snati	Snati	Snati	Snati	Snati
4	19UPIA0447	Saranyaf	Saranyaf	Saranyaf	Saranyaf	Saranyaf
5	19UPIA0448	Anusha	Anusha	Anusha	Anusha	Anusha
6	19UPIA0450	Varsh	Varsh	Varsh	Varsh	Varsh
7	19UPIA0451	Jashu	Jashu	Jashu	Jashu	Jashu
8	19UPIA0452	Madhavi	Madhavi	Madhavi	Madhavi	Madhavi
9	19UPIA0453	Sahithaya	Sahithaya	Sahithaya	Sahithaya	Sahithaya
10	19UPIA0454		Varshani	Varshani	Varshani	Varshani
11	19UPIA0455	Smisha	Smisha	Smisha	Smisha	Smisha
12	19UPIA0456	Nishat	Nishat	Nishat	Nishat	Nishat
13	19UPIA0457	Harsh	Harsh	Harsh	Harsh	Harsh
14	19UPIA0458	Sneha	Sneha	Sneha	Sneha	Sneha
15	19UPIA0459	Durga	Durga	Durga	Durga	Durga
16	19UPIA0460					
17	19UPIA0461	Soumya	Soumya	Soumya	Soumya	Soumya
18	19UPIA0463	Jashu	Jashu	Jashu	Jashu	Jashu
19	19UPIA0464					
20	19UPIA0465	Prasanna	Prasanna	Prasanna	Prasanna	Prasanna
21	19UPIA0466	Likitha	Likitha	Likitha	Likitha	Likitha
22	19UPIA0467	Santosh	Santosh	Santosh	Santosh	Santosh
23	19UPIA0468	Yujitha	Yujitha	Yujitha	Yujitha	Yujitha
24	19UPIA0469	Deepika	Deepika	Deepika	Deepika	Deepika
25	19UPIA0470	Bhuvaneshwari	Bhuvaneshwari	Bhuvaneshwari	Bhuvaneshwari	Bhuvaneshwari
26	19UPIA0471	Uma	Uma	Uma	Uma	Uma
27	19UPIA0472	Deekshitha	Deekshitha	Deekshitha	Deekshitha	Deekshitha
28	19UPIA0473	Hiranmay	Hiranmay	Hiranmay	Hiranmay	Hiranmay
29	19UPIA0474	Chandana	Chandana	Chandana	Chandana	Chandana
30	19UPIA0475	chandana	chandana	chandana	chandana	chandana
31	19UPIA0476	Varshani	Varshani	Varshani	Varshani	Varshani
32	19UPIA0477	Sanya	Sanya	Sanya	Sanya	Sanya



**PRINCIPAL**

Vignans Institute of Management & Technology For Women  
Kondapur(V), Ghatkesar(M), Medchal-Malkajgiri(D)-501301  
Telangana State

33	19UPIA0478	Akshitha	Akshitha	Akshitha	Akshitha	Akshitha
34	19UPIA0479	Shravani	Shravani	Shravani	Shravani	Shravani
35	19UPIA0481	Ancey	Ancey	Ancey	Ancey	Ancey
36	19UPIA0482	Naga	AB	Naga	Naga	Naga
37	20UP5A0410	Anshu	Anshu	Anshu	Anshu	Anshu
38	20UP5A0411	Yamini	Yamini	Yamini	Yamini	Yamini
39	20UP5A0412	bhargavi	bhargavi	bhargavi	bhargavi	bhargavi
40	20UP5A0413	chandu	chandu	chandu	chandu	chandu
41	20UP5A0414	Sravani	Sravani	Sravani	Sravani	Sravani
42	20UP5A0415	Anusha	Anusha	Anusha	Anusha	Anusha
43	20UP5A0416	narmatha	narmatha	narmatha	narmatha	narmatha
44	20UP5A0418	Y	Y	Y	Y	Y
45	20UP5A0419	Y.Sharni	Y.Sharni	Y.Sharni	Y.Sharni	Y.Sharni

  
COORDINATOR

  
HOD

Head of the Department  
Electronics and Communication Engineering  
Vignana's Institute of Management & Technology For Women  
Kondapur (V), Ghatkesar (M), Medchal-Malkajgiri (DI)-501301



  
PRINCIPAL  
Vignana's Institute of Management & Technology For Women  
Kondapur(V),Ghatkesar(M),Medchal-Malkajgiri(DI)-501301  
Telangana State



# VIGNAN'S INSTITUTE OF MANAGEMENT AND TECHNOLOGY FOR WOMEN

Sponsored by Lavu Educational Society, Approved by AICTE, New Delhi & Affiliated to JNTUH, Hyderabad.  
Kondapur (V), Ghatkesar (M), Medchal - Malkajgiri (D) - 501 301 Phone: +91 96529 10002/3



## DEPARTMENT OF ELECTRONICS AND COMMUNICATION ENGINEERING

ADD ON COURSE NAME: Design of Smart Antenna Systems and Its Importance

DAY WISE ATTENDANCE SHEET

Academic Year : 2021-2022

Date : 06-10-2021

B.Tech III-I SEM

SECTION : ECE-A

S.No	Roll Number	06-10-21	07-10-21	08-10-21	18-10-21	19-10-21
1	19UPIA0401	<del>Sneha</del>	<del>Sneha</del>	<del>Sneha</del>	<del>Sneha</del>	<del>Sneha</del>
2	19UPIA0402	Rasagna	Rasagna	Rasagna	Rasagna	Rasagna
3	19UPIA0403	Vignatha	Vignatha	Vignatha	Vignatha	Vignatha
4	19UPIA0404	Pavani	Pavani	Pavani	Pavani	Pavani
5	19UPIA0405	Keerthi	Keerthi	Keerthi	Keerthi	Keerthi
6	19UPIA0406	D.Sravya	D.Sravya	D.Sravya	D.Sravya	D.Sravya
7	19UPIA0407	G.abhi	G.abhi	G.abhi	G.abhi	G.abhi
8	19UPIA0409	deepthi	deepthi	deepthi	deepthi	deepthi
9	19UPIA0410	<del>Vij</del>	<del>Vij</del>	<del>Vij</del>	<del>Vij</del>	<del>Vij</del>
10	19UPIA0411	G.Swetha	G.Swetha	G.Swetha	G.Swetha	G.Swetha
11	19UPIA0412	Nishitha	Nishitha	Nishitha	Nishitha	Nishitha
12	19UPIA0413	Charitha	Charitha	Charitha	Charitha	Charitha
13	19UPIA0414	Mahathaf	Mahathaf	Mahathaf	Mahathaf	Mahathaf
14	19UPIA0415	K.Lakshmi	K.Lakshmi	K.Lakshmi	K.Lakshmi	K.Lakshmi
15	19UPIA0416	Meghana	Meghana	Meghana	Meghana	Meghana
16	19UPIA0417	Tejaswini	Tejaswini	Tejaswini	Tejaswini	Tejaswini
17	19UPIA0418	Pravalika	Pravalika	Pravalika	Pravalika	Pravalika
18	19UPIA0419	L.Abhinaya	L.Abhinaya	L.Abhinaya	L.Abhinaya	L.Abhinaya
19	19UPIA0421	Lavanya	Lavanya	Lavanya	Lavanya	Lavanya
20	19UPIA0422	Priya	Priya	Priya	Priya	Priya
21	19UPIA0423	<del>Lavanya</del>	AB	Lavanya	Lavanya	Lavanya
22	19UPIA0424	Pavani	Pavani	Pavani	Pavani	Pavani
23	19UPIA0425	Prasanna	Prasanna	Prasanna	Prasanna	Prasanna
24	19UPIA0426	sindhu P	sindhu P	sindhu P	sindhu P	sindhu P
25	19UPIA0427	Mahi	Mahi	Mahi	Mahi	Mahi
26	19UPIA0429	<del>S</del>	<del>S</del>	<del>S</del>	<del>S</del>	<del>S</del>
27	19UPIA0430	Jaya	Jaya	Jaya	Jaya	Jaya
28	19UPIA0431	sathvika	sathvika	sathvika	sathvika	sathvika
29	19UPIA0432	Anitha	Anitha	Anitha	Anitha	Anitha
30	19UPIA0433	Akshaya	Akshaya	Akshaya	Akshaya	Akshaya



  
PRINCIPAL

Vignans Institute of Management & Technology for Women  
Kondapur(V), Ghatkesar(M), Medchal-Malkajgiri(D)-501301  
Telangana State

31	19UP1A0434	(V)	(V)	(V)	(V)	(V)
32	19UP1A0435	Likhita	Likhita	Likhita	Likhita	Likhita
33	19UP1A0436	<del>Harsh</del>	<del>Harsh</del>	<del>Harsh</del>	<del>Harsh</del>	<del>Harsh</del>
34	19UP1A0437	Geeya	Geeya	Geeya	Geeya	Geeya
35	19UP1A0439	V. Ashvitha	V. Ashvitha	V. Ashvitha	V. Ashvitha	V. Ashvitha
36	19UP1A0440	V. Sangitha	V. Sangitha	V. Sangitha	V. Sangitha	V. Sangitha
37	19UP1A0441	Vasundhara	Vasundhara	Vasundhara	Vasundhara	Vasundhara
38	19UP1A0442	Manasa	Manasa	Manasa	Manasa	Manasa
39	20UP5A0401	Bharathi	Bharathi	Bharathi	Bharathi	Bharathi
40	20UP5A0403	Anusha	Anusha	Anusha	Anusha	Anusha
41	20UP5A0404	<del>Anusha</del>	<del>Anusha</del>	AB	<del>Anusha</del>	<del>Anusha</del>
42	20UP5A0405	Vashta	Vashta	Vashta	Vashta	Vashta
43	20UP5A0406	(A)	(A)	(A)	(A)	(A)
44	20UP5A0407	Chethana	Chethana	Chethana	Chethana	Chethana
45	20UP5A0409	Saumika	Saumika	Saumika	Saumika	Saumika

  
COORDINATOR

  
HOD

Head of the Department  
Electronics and Communication Engineering  
Vignans Institute of Management & Technology For Women  
Kondapur (V), Ghatkesar (M), Medchal-Malkajgiri (DI)-501301, T.S.



  
PRINCIPAL  
Vignans Institute of Management & Technology For Women  
Kondapur (V), Ghatkesar (M), Medchal-Malkajgiri (DI)-501301  
Telangana State





# VIGNAN'S INSTITUTE OF MANAGEMENT AND TECHNOLOGY FOR WOMEN

Sponsored by Lawu Educational Society, Approved by AICTE, New Delhi & Affiliated to JNTUH, Hyderabad.  
Kondapur (V), Ghatkesar (M), Medchal - Malkajgiri (D) - 501 301 Phone: +91 98529 10002/3



## DEPARTMENT OF ELECTRONICS AND COMMUNICATION ENGINEERING

ADD ON COURSE NAME: Design of Smart Antenna Systems and Its Importance

DAY WISE ATTENDANCE SHEET

Academic Year : 2021-2022

Date : 06-10-2021

B.Tech III-I SEM

SECTION : ECE-8

S.No	Roll Number	06-10-21	07-10-21	08-10-21	18-10-21	19-10-21
1	19UPIA0443	Kavya	Kavya	Kavya	Kavya	Kavya
2	19UPIA0444	Praji	Praji	Praji	Praji	Praji
3	19UPIA0446	Snigdha	Snigdha	Snigdha	Snigdha	Snigdha
4	19UPIA0447	Saranyal	Saranyal	Saranyal	Saranyal	Saranyal
5	19UPIA0448	Amisha	Amisha	Amisha	Amisha	Amisha
6	19UPIA0450	Vaishali	Vaishali	Vaishali	Vaishali	Vaishali
7	19UPIA0451	Jashna	Jashna	Jashna	AB	Jashna
8	19UPIA0452	Madhavi	Madhavi	Madhavi	Madhavi	Madhavi
9	19UPIA0453	Sahithaya	Sahithaya	Sahithaya	Sahithaya	Sahithaya
10	19UPIA0454	Vaishnavi	Vaishnavi	Vaishnavi	Vaishnavi	Vaishnavi
11	19UPIA0455	Sirisha	Sirisha	Sirisha	Sirisha	Sirisha
12	19UPIA0456	Nishita	Nishita	Nishita	Nishita	Nishita
13	19UPIA0457	Harsh	Harsh	Harsh	Harsh	Harsh
14	19UPIA0458	Sneha	Sneha	Sneha	Sneha	Sneha
15	19UPIA0459	Dinika	Dinika	Dinika	Dinika	Dinika
16	19UPIA0460	A	A	A	A	A
17	19UPIA0461	Srujanika	Srujanika	Srujanika	Srujanika	Srujanika
18	19UPIA0463	Jashu	Jashu	Jashu	Jashu	Jashu
19	19UPIA0464	A	A	A	A	A
20	19UPIA0465	Prasanna	Prasanna	Prasanna	Prasanna	Prasanna
21	19UPIA0466	Likitha	Likitha	Likitha	Likitha	Likitha
22	19UPIA0467	Arthika	Arthika	Arthika	Arthika	Arthika
23	19UPIA0468	Yujitha	Yujitha	Yujitha	Yujitha	Yujitha
24	19UPIA0469	Deepika	Deepika	Deepika	Deepika	Deepika
25	19UPIA0470	Bhuvanika	AB	Bhuvanika	Bhuvanika	Bhuvanika
26	19UPIA0471	Uma	Uma	Uma	Uma	Uma
27	19UPIA0472	Deekshitha	Deekshitha	Deekshitha	Deekshitha	Deekshitha
28	19UPIA0473	Hiranmayi	Hiranmayi	Hiranmayi	Hiranmayi	Hiranmayi
29	19UPIA0474	Chandana	Chandana	Chandana	Chandana	Chandana
30	19UPIA0475	Chandana	Chandana	Chandana	Chandana	Chandana



*AS*  
PRINCIPAL

Vignans Institute of Management & Technology For Women  
Kondapur(V), Ghatkesar(M), Medchal-Malkajgiri(D)-501301  
Telangana State

31	19UP1A0476	<del>Keerthi</del>	<del>Keerthi</del>	<del>Keerthi</del>	<del>Keerthi</del>	<del>Keerthi</del>	<del>Keerthi</del>
32	19UP1A0477	<del>Keerthi</del>	<del>Keerthi</del>	<del>Keerthi</del>	<del>Keerthi</del>	<del>Keerthi</del>	<del>Keerthi</del>
33	19UP1A0478	Akshitha	Akshitha	Akshitha	Akshitha	Akshitha	Akshitha
34	19UP1A0479	Shravani	Shravani	Shravani	Shravani	Shravani	Shravani
35	19UP1A0481	Anoushka	Anoushka	Anoushka	Anoushka	Anoushka	Anoushka
36	19UP1A0482	Naga	Naga	Naga	Naga	Naga	Naga
37	20UP5A0410	<del>Yamini</del>	<del>Yamini</del>	<del>Yamini</del>	<del>Yamini</del>	<del>Yamini</del>	<del>Yamini</del>
38	20UP5A0411	Yamini	Yamini	Yamini	Yamini	Yamini	Yamini
39	20UP5A0412	bhargavi	bhargavi	bhargavi	bhargavi	bhargavi	bhargavi
40	20UP5A0413	Chandu	Chandu	Chandu	Chandu	Chandu	Chandu
41	20UP5A0414	Sravani	Sravani	Sravani	Sravani	Sravani	Sravani
42	20UP5A0415	Anoushka	Anoushka	Anoushka	Anoushka	Anoushka	Anoushka
43	20UP5A0416	namratha	namratha	namratha	namratha	namratha	namratha
44	20UP5A0418	<del>Yamini</del>	<del>Yamini</del>	<del>Yamini</del>	<del>Yamini</del>	<del>Yamini</del>	<del>Yamini</del>
45	20UP5A0419	Y.Sharnili	Y.Sharnili	AB	Y.Sharnili	Y.Sharnili	Y.Sharnili

  
COORDINATOR

  
HOD

Head of the Department  
Electronics and Communication Engineering  
Vignans Institute of Management & Technology For Women  
Kondapur (V), Ghatkesar (M), Medchal-Malkajgiri (Dt)-501301



  
RITIKA AL  
Vignans Institute of Management & Technology For Women  
Kondapur(V),Ghatkesar(M),Medchal-Malkajgiri(Dt)-501301  
Telangana State



# VIGNAN'S INSTITUTE OF MANAGEMENT AND TECHNOLOGY FOR WOMEN

Sponsored by Laxmi Educational Society, Approved by AICTE, New Delhi & Affiliated to JNTUH, Hyderabad.  
Kondapur (V), Ghatkesar (M), Medchal - Malkajgiri (D) - 501 301 Phone: +91 96529 10002/3



## DEPARTMENT OF ELECTRONICS AND COMMUNICATION ENGINEERING

ADD ON COURSE NAME: Design of Smart Antenna Systems and Its Importance

DAY WISE ATTENDANCE SHEET

Academic Year : 2021-2022

Date : 20-10-2021

B.Tech III-I SEM

SECTION : ECE-A

S.No	Roll Number	20-10-21	21-10-21	22-10-21	23-10-21	25-10-21	26-10-21
1	19UPIA0401	sneha	sneha	sneha	sneha	sneha	sneha
2	19UPIA0402	Kasarna	Kasarna	Kasarna	Kasarna	Kasarna	Kasarna
3	19UPIA0403	Vignath	Vignath	Vignath	Vignath	Vignath	Vignath
4	19UPIA0404	Pavani	Pavani	Pavani	Pavani	Pavani	Pavani
5	19UPIA0405	Keerthi	Keerthi	Keerthi	Keerthi	Keerthi	Keerthi
6	19UPIA0406	D.sarav	D.sarav	D.sarav	D.sarav	D.sarav	D.sarav
7	19UPIA0407	G.abhi	G.abhi	G.abhi	G.abhi	G.abhi	G.abhi
8	19UPIA0409	deepthi	deepthi	deepthi	deepthi	deepthi	deepthi
9	19UPIA0410	IS	IS	IS	IS	IS	IS
10	19UPIA0411	G.Sweethe	G.Sweethe	G.Sweethe	G.Sweethe	G.Sweethe	G.Sweethe
11	19UPIA0412	Nishitha	Nishitha	Nishitha	Nishitha	Nishitha	Nishitha
12	19UPIA0413	Charitha	Charitha	Charitha	Charitha	Charitha	Charitha
13	19UPIA0414	Mohathf	Mohathf	Mohathf	Mohathf	Mohathf	Mohathf...
14	19UPIA0415	K.lakar	K.lakar	K.lakar	K.lakar	K.lakar	K.lakar
15	19UPIA0416	Meghana	Meghana	Meghana	Meghana	Meghana	Meghana
16	19UPIA0417	Tejaswini	Tejaswini	Tejaswini	Tejaswini	Tejaswini	Tejaswini
17	19UPIA0418	Pravalika	Pravalika	Pravalika	AB	Pravalika	Pravalika
18	19UPIA0419	L.Abhinaya	L.Abhinaya	L.Abhinaya	L.Abhinaya	L.Abhinaya	L.Abhinaya
19	19UPIA0421	Lavanya	Lavanya	Lavanya	Lavanya	Lavanya	Lavanya
20	19UPIA0422	Priya	Priya	Priya	Priya	Priya	Priya
21	19UPIA0423	Lavanya	Lavanya	Lavanya	Lavanya	Lavanya	Lavanya
22	19UPIA0424	Pavani	Pavani	Pavani	Pavani	Pavani	Pavani
23	19UPIA0425	Prasanna	Prasanna	Prasanna	Prasanna	Prasanna	Prasanna
24	19UPIA0426	sindhu	sindhu	sindhu	sindhu	sindhu	sindhu
25	19UPIA0427	Mahi	Mahi	Mahi	Mahi	Mahi	Mahi
26	19UPIA0429	G	G	G	G	G	G
27	19UPIA0430	Jaya	Jaya	Jaya	Jaya	Jaya	Jaya
28	19UPIA0431	sathwika	sathwika	sathwika	sathwika	sathwika	sathwika
29	19UPIA0432	Anitha	Anitha	Anitha	Anitha	Anitha	Anitha
30	19UPIA0433	Aleshaya	Aleshaya	Aleshaya	Aleshaya	Aleshaya	Aleshaya



PRINCIPAL  
Vignans Institute of Management & Technology For Women  
Kondapur(V), Ghatkesar(M), Medchal-Malkajgiri(D)-501301  
Telangana State

31	19UPIA0434	⓪	⓪	⓪	⓪	⓪	⓪
32	19UPIA0435	Likhita	Likhita	Likhita	Likhita	Likhita	Likhita
33	19UPIA0436	Harsh	Harsh	Harsh	Harsh	Harsh	Harsh
34	19UPIA0437	Sreya	Sreya	Sreya	Sreya	Sreya	Sreya
35	19UPIA0439	V. Ashwika	V. Ashwika	V. Ashwika	V. Ashwika	V. Ashwika	A. Ashwika
36	19UPIA0440	V. Sangitha	AB	V. Sangitha	V. Sangitha	V. Sangitha	V. Sangitha
37	19UPIA0441	Vasundhara	vasundhara	vasundhara	vasundhara	vasundhara	vasundhara
38	19UPIA0442	Manasa	Manasa	Manasa	Manasa	Manasa	Manasa
39	20UP5A0401	Bharathi	Bharathi	Bharathi	Bharathi	Bharathi	Bharathi
40	20UP5A0403	Anusha	Anusha	Anusha	Anusha	Anusha	Anusha
41	20UP5A0404	Anusha	Anusha	Anusha	Anusha	Anusha	Anusha
42	20UP5A0405	Kashta	Kashta	Kashta	Kashta	Kashta	Kashta
43	20UP5A0406	⓪	⓪	⓪	⓪	⓪	⓪
44	20UP5A0407	Chethana	Chethana	Chethana	Chethana	Chethana	Chethana
45	20UP5A0409	Sumita	sumita	sounita	sounita	sounita	sounita

  
COORDINATOR

  
HOD

Head of the Department of  
Commerce and Communications Engineering  
Vignans Institute of Management & Technology for  
Women (V), Ghateker (M), Medchal-Malkajgiri (Dist-501301)  
Telangana State



BRINDA  
Vignans Institute of Management & Technology for Women  
Kondapur (V), Ghateker (M), Medchal-Malkajgiri (Dist-501301)  
Telangana State



# VIGNAN'S INSTITUTE OF MANAGEMENT AND TECHNOLOGY FOR WOMEN

Sponsored by Levu Educational Society, Approved by AICTE, New Delhi & Affiliated to JNTUH, Hyderabad.  
Kondapur (V), Ghatkesar (M), Medchal - Malkajgiri (D) - 501 301 Phone: +91 96529 10002/3



## DEPARTMENT OF ELECTRONICS AND COMMUNICATION ENGINEERING

ADD ON COURSE NAME: Design of Smart Antenna Systems and Its Importance

DAY WISE ATTENDANCE SHEET

Academic Year : 2021-2022

Date : 20-10-2021

B.Tech III-I SEM

SECTION : ECE-B

S.No	Roll Number	20-10-21	21-10-21	22-10-21	23-10-21	25-10-21	26-10-21
1	19UPIA0443	Kavya	Kavya	Kavya	Kavya	Kavya	Kavya
2	19UPIA0444	Prati	Prati	Prati	Prati	Prati	Prati
3	19UPIA0446	Smit	Smit	Smit	Smit	Smit	Smit
4	19UPIA0447	Saranyal	Saranyal	Saranyal	Saranyal	Saranyal	Saranyal
5	19UPIA0448	Amelia	Amelia	Amelia	Amelia	Amelia	Amelia
6	19UPIA0450	Vashli	AB	Vashli	Vashli	Vashli	Vashli
7	19UPIA0451	Jashna	Jashna	Jashna	Jashna	Jashna	Jashna
8	19UPIA0452	Madhavi	Madhavi	Madhavi	Madhavi	Madhavi	Madhavi
9	19UPIA0453	Sahithaya	Sahithaya	Sahithaya	Sahithaya	Sahithaya	Sahithaya
10	19UPIA0454	Varshada	Varshada	Varshada	Varshada	Varshada	Varshada
11	19UPIA0455	Sirisha	Sirisha	Sirisha	Sirisha	Sirisha	Sirisha
12	19UPIA0456	Nisha	Nisha	Nisha	Nisha	Nisha	Nisha
13	19UPIA0457	Harsh	Harsh	Harsh	Harsh	Harsh	Harsh
14	19UPIA0458	snaha	snaha	snaha	snaha	snaha	snaha
15	19UPIA0459	Danya	Danya	Danya	Danya	Danya	Danya
16	19UPIA0460	Somya	Somya	Somya	Somya	Somya	Somya
17	19UPIA0461	A	A	A	A	A	A
18	19UPIA0463	Jashu	Jashu	Jashu	Jashu	Jashu	Jashu
19	19UPIA0464	f	f	f	f	f	f
20	19UPIA0465	Prasanna	Prasanna	Prasanna	Prasanna	Prasanna	Prasanna
21	19UPIA0466	Likitha	Likitha	Likitha	Likitha	Likitha	Likitha
22	19UPIA0467	Santhi	Santhi	Santhi	Santhi	Santhi	Santhi
23	19UPIA0468	Yujitha	Yujitha	Yujitha	Yujitha	Yujitha	Yujitha
24	19UPIA0469	Deepika	Deepika	Deepika	Deepika	Deepika	Deepika
25	19UPIA0470	Bhuvanesh	Bhuvanesh	Bhuvanesh	Bhuvanesh	Bhuvanesh	Bhuvanesh
26	19UPIA0471	Lina	Lina	Lina	Lina	Lina	Lina
27	19UPIA0472	Deekshitha	Deekshitha	Deekshitha	Deekshitha	Deekshitha	Deekshitha
28	19UPIA0473	Hiranmay	Hiranmay	Hiranmay	Hiranmay	Hiranmay	Hiranmay
29	19UPIA0474	Chardana	Chardana	Chardana	Chardana	Chardana	Chardana
30	19UPIA0475	chardana	chardana	chardana	chardana	chardana	chardana



**PRINCIPAL**

Vignans Institute of Management & Technology For Women  
-V, Ghatkesar(M), Medchal-Malkajgiri(D)-501301  
Telangana State

31	19UPIA0476					
32	19UPIA0477	Geetha	Geetha	Geetha	Geetha	Geetha
33	19UPIA0478	Akshitha	Akshitha	Akshitha	Akshitha	Akshitha
34	19UPIA0479	Shravani	Shravani	Shravani	Shravani	Shravani
35	19UPIA0481	Anoush	AB	Anoush	Anoush	Anoush
36	19UPIA0482	Naga	Naga	Naga	Naga	Naga
37	20UP5A0410					
38	20UP5A0411	Yamini	Yamini	Yamini	Yamini	Yamini
39	20UP5A0412	bhargavi	bhargavi	bhargavi	bhargavi	bhargavi
40	20UP5A0413	Chandu	Chandu	Chandu	Chandu	Chandu
41	20UP5A0414	Sravani	Sravani	Sravani	Sravani	Sravani
42	20UP5A0415	Anusha	Anusha	Anusha	Anusha	Anusha
43	20UP5A0416	namratha	namratha	namratha	namratha	namratha
44	20UP5A0418					
45	20UP5A0419	Y. Shamili	Y. Shamili	Y. Shamili	Y. Shamili	Y. Shamili

COORDINATOR

HOD

Head of the Department  
Electronics and Communication Engineering  
Woman's Institute of Management & Technology For Women  
Kondapur (V), Ghatkesar (M), Medchal-Malkajgiri (DT)-501301



PRINCIPAL

Woman's Institute of Management & Technology For Women  
Kondapur(V), Ghatkesar(M), Medchal-Malkajgiri(DT),  
Telangana State



# VIGNAN'S INSTITUTE OF MANAGEMENT AND TECHNOLOGY FOR WOMEN

Sponsored by Laxmi Educational Society, Approved by AICTE, New Delhi & Affiliated to JNTUH, Hyderabad.  
Kondapur (V), Ghatkesar (M), Medchal - Malkajgiri (D) - 501 301 Phone: +91 96529 10002/3



## DEPARTMENT OF ELECTRONICS AND COMMUNICATION ENGINEERING

ADD ON COURSE NAME: Design of Smart Antenna Systems and Its Importance

DAY WISE ATTENDANCE SHEET

Academic Year : 2021-2022

Date : 27-10-2021

B.Tech III-I SEM

SECTION : ECE-A

S. No	Roll Number	27-10-21	28-10-21	29-10-21	30-10-21	01-11-21	02-11-21
1	19UPIA0401	sneha	sneha	sneha	sneha	sneha	sneha
2	19UPIA0402	Rasagna	Rasagna	Rasagna	Rasagna	Rasagna	Rasagna
3	19UPIA0403	Vignadha	Vignadha	Vignadha	Vignadha	Vignadha	Vignadha
4	19UPIA0404	Pavani	Pavani	Pavani	Pavani	Pavani	Pavani
5	19UPIA0405	keerthi	keerthi	keerthi	keerthi	keerthi	keerthi
6	19UPIA0406	D.sravya	D.sravya	D.sravya	D.sravya	D.sravya	D.sravya
7	19UPIA0407	G.abhi	G.abhi	G.abhi	G.abhi	G.abhi	G.abhi
8	19UPIA0409	deepthi	deepthi	deepthi	deepthi	deepthi	deepthi
9	19UPIA0410	Pt	Pt	Pt	Pt	Pt	Pt
10	19UPIA0411	G.Swettha	G.Swettha	G.Swettha	G.Swettha	G.Swettha	G.Swettha
11	19UPIA0412	Nishitha	Nishitha	Nishitha	Nishitha	Nishitha	Nishitha
12	19UPIA0413	Charitha	Charitha	Charitha	Charitha	Charitha	Charitha
13	19UPIA0414	Mahathul	Mahathul	Mahathul	Mahathul	Mahathul	Mahathul
14	19UPIA0415	K.Lahari	K.Lahari	K.Lahari	K.Lahari	K.Lahari	K.Lahari
15	19UPIA0416	Meghana	Meghana	Meghana	Meghana	Meghana	Meghana
16	19UPIA0417	Tejaswini	Tejaswini	Tejaswini	Tejaswini	Tejaswini	Tejaswini
17	19UPIA0418	Pravalika	Pravalika	Pravalika	Pravalika	Pravalika	Pravalika
18	19UPIA0419	Abhinaya	Abhinaya	Abhinaya	Abhinaya	Abhinaya	Abhinaya
19	19UPIA0421	Lavanya	Lavanya	Lavanya	Lavanya	Lavanya	Lavanya
20	19UPIA0422	Priya	Priya	Priya	Priya	Priya	Priya
21	19UPIA0423	Lavanya	Lavanya	Lavanya	Lavanya	Lavanya	Lavanya
22	19UPIA0424	Pavani	Pavani	Pavani	Pavani	Pavani	Pavani
23	19UPIA0425	Prasanna	Prasanna	Prasanna	Prasanna	Prasanna	Prasanna
24	19UPIA0426	s.indhu p	s.indhu p	s.indhu p	s.indhu p	s.indhu p	s.indhu p
25	19UPIA0427	Mali	Mali	Mali	Mali	Mali	Mali
26	19UPIA0429	G.jaya	G.jaya	G.jaya	G.jaya	G.jaya	G.jaya
27	19UPIA0430	G.jaya	G.jaya	G.jaya	G.jaya	G.jaya	G.jaya
28	19UPIA0431	sathvika	sathvika	sathvika	sathvika	sathvika	sathvika
29	19UPIA0432	Anitha	Anitha	Anitha	Anitha	Anitha	Anitha



*[Signature]*  
PRINCIPAL  
Vignans Institute of Management & Technology For Women  
Kondapur(V), Ghatkesar(M), Medchal-Malkajgiri(D)-501301  
Telangana State

30	19UPIA0433	Aleshaya	Aleshaya	Aleshaya	Aleshaya	Aleshaya	Aleshaya
31	19UPIA0434	Likhita	Likhita	Likhita	Likhita	Likhita	Likhita
32	19UPIA0435	Harsh	Harsh	Harsh	Harsh	Harsh	Harsh
33	19UPIA0436	Harsh	Harsh	Harsh	Harsh	Harsh	Harsh
34	19UPIA0437	Sanya	Sanya	Sanya	Sanya	Sanya	Sanya
35	19UPIA0439	V. Ashvitha	V. Ashvitha	V. Ashvitha	V. Ashvitha	V. Ashvitha	V. Ashvitha
36	19UPIA0440	V. Sangita	V. Sangita	V. Sangita	V. Sangita	V. Sangita	V. Sangita
37	19UPIA0441	Vasundhara	Vasundhara	Vasundhara	Vasundhara	Vasundhara	Vasundhara
38	19UPIA0442	Manasa	Manasa	Manasa	Manasa	Manasa	Manasa
39	20UP5A0401	Bharathi	Bharathi	Bharathi	Bharathi	Bharathi	Bharathi
40	20UP5A0403	Anusha	Anusha	Anusha	Anusha	Anusha	Anusha
41	20UP5A0404	Anusha	Anusha	Anusha	Anusha	Anusha	Anusha
42	20UP5A0405	Vasha	Vasha	Vasha	Vasha	Vasha	Vasha
43	20UP5A0406	Chethana	Chethana	Chethana	Chethana	Chethana	Chethana
44	20UP5A0407	Chethana	Chethana	Chethana	Chethana	Chethana	Chethana
45	20UP5A0409	Saumita	Saumita	Saumita	Saumita	Saumita	Saumita

  
COORDINATOR

  
HOD

Head of the Department  
Electronics and Communications Engineering  
Vignans Institute of Management & Technology For Women  
Kondapur (V), Ghatkesar (M), Medchal-Malkajgiri (Dt) - 501301  
T.S.



  
PRINCIPAL  
Vignans Institute of Management & Technology For Women  
Kondapur (V), Ghatkesar (M), Medchal-Malkajgiri (Dt) - 501301  
Telangana State





# VIGNAN'S INSTITUTE OF MANAGEMENT AND TECHNOLOGY FOR WOMEN

Sponsored by Lavu Educational Society, Approved by AICTE, New Delhi & Affiliated to JNTUH, Hyderabad.  
Kondapur (V), Ghatkesar (M), Medchal - Malkajgiri (D) - 501 301 Phone: +91 96529 10002/3



## DEPARTMENT OF ELECTRONICS AND COMMUNICATION ENGINEERING

ADD ON COURSE NAME: Design of Smart Antenna Systems and Its Importance

DAY WISE ATTENDANCE SHEET

Academic Year : 2021-2022

Date : 27-10-2021

B.Tech III-I SEM

SECTION : ECE-B

S.No	Roll Number	27-10-21	28-10-21	29-10-21	30-10-21	01-11-21	02-11-21
1	19UPIA0443	Prat	Prat	Raj	Prat	Prat	Prat
2	19UPIA0444	Kavya	Kavya	Kavya	Kavya	Kavya	Kavya
3	19UPIA0446	Smt	Smt	Smt	Smt	Smt	Smt
4	19UPIA0447	Sarany	Sarany	Sarany	Sarany	Sarany	Sarany
5	19UPIA0448	Amisha	Amisha	Amisha	Amisha	Amisha	Amisha
6	19UPIA0450	Vaish	Vaish	Vaish	Vaish	Vaish	Vaish
7	19UPIA0451	Jash	Jash	Jash	Jash	Jash	Jash
8	19UPIA0452	Neelha	Neelha	Neelha	Neelha	Neelha	Neelha
9	19UPIA0453	Sahithya	Sahithya	Sahithya	Sahithya	Sahithya	Sahithya
10	19UPIA0454	Varsha	Varsha	Varsha	Varsha	Varsha	Varsha
11	19UPIA0455	Sirisha	Sirisha	Sirisha	Sirisha	Sirisha	Sirisha
12	19UPIA0456	Nish	Nish	Nish	Nish	Nish	Nish
13	19UPIA0457	Karth	Karth	Karth	Karth	Karth	Karth
14	19UPIA0458	Sneha	Sneha	Sneha	Sneha	Sneha	Sneha
15	19UPIA0459	Riya	Riya	Riya	Riya	Riya	Riya
16	19UPIA0460	Smt	Smt	Smt	Smt	Smt	Smt
17	19UPIA0461	Sowmya	Sowmya	Sowmya	Sowmya	Sowmya	Sowmya
18	19UPIA0463	Jash	Jash	Jash	Jash	Jash	Jash
19	19UPIA0464	Smt	Smt	Smt	Smt	Smt	Smt
20	19UPIA0465	Prasanna	Prasanna	Prasanna	Prasanna	Prasanna	Prasanna
21	19UPIA0466	Likitha	Likitha	Likitha	Likitha	Likitha	Likitha
22	19UPIA0467	Santhi	Santhi	Santhi	Santhi	Santhi	Santhi
23	19UPIA0468	Yujitha	Yujitha	Yujitha	Yujitha	Yujitha	Yujitha
24	19UPIA0469	Deepika	Deepika	Deepika	Deepika	Deepika	Deepika
25	19UPIA0470	Bhuvanika	Bhuvanika	Bhuvanika	Bhuvanika	Bhuvanika	Bhuvanika
26	19UPIA0471	Uma	Uma	Uma	Uma	Uma	Uma
27	19UPIA0472	Deekshitha	Deekshitha	Deekshitha	Deekshitha	Deekshitha	Deekshitha
28	19UPIA0473	Hiranmay	Hiranmay	Hiranmay	Hiranmay	Hiranmay	Hiranmay
29	19UPIA0474	Chardana	Chardana	Chardana	Chardana	Chardana	Chardana



*Asw*  
PRINCIPAL

Vignans Institute of Management & Technology For Women  
Kondapur(V), Ghatkesar(M), Medchal - Malkajgiri(D) - 501301  
Telangana State

30	19UP1A0475	chandara	chandara	chandara	chandara	chandara	chandara
31	19UP1A0476	↓	↓	↓	↓	↓	↓
32	19UP1A0477	keeya	keeya	keeya	keeya	keeya	keeya
33	19UP1A0478	Akshitha	Akshitha	Akshitha	Akshitha	Akshitha	Akshitha
34	19UP1A0479	shravani	shravani	shravani	shravani	shravani	shravani
35	19UP1A0481	Ancef	Ancef	Ancef	Ancef	Ancef	Ancef
36	19UP1A0482	Naga	Naga	Naga	Naga	Naga	Naga
37	20UP5A0410	dub	dub	dub	dub	dub	dub
38	20UP5A0411	Yamini	Yamini	Yamini	Yamini	Yamini	Yamini
39	20UP5A0412	brahmagavi	brahmagavi	brahmagavi	brahmagavi	brahmagavi	brahmagavi
40	20UP5A0413	chandu	chandu	chandu	chandu	chandu	chandu
41	20UP5A0414	Sravani	Sravani	Sravani	Sravani	Sravani	Sravani
42	20UP5A0415	Anusha	AP	Anusha	Anusha	Anusha	Anusha
43	20UP5A0416	namatha	namatha	namatha	namatha	namatha	namatha
44	20UP5A0418	↓	↓	↓	↓	↓	↓
45	20UP5A0419	Y.Shamili	Y.Shamili	Y.Shamili	Y.Shamili	Y.Shamili	Y.Shamili

  
COORDINATOR

  
HOD

Head of the Department  
Electronics and Communication Engineering  
Vignani's Institute of Management & Technology For Women  
Kondapur (V), Ghatkesar (M), Medchal-Malkajgiri (Dt)-501301



  
PRINCIPAL  
Vignani's Institute of Management & Technology For Women  
Kondapur (V), Ghatkesar (M), Medchal-Malkajgiri (Dt)-501301  
Telangana State



**DEPARTMENT OF ELECTRONICS AND COMMUNICATION ENGINEERING**

Date: 04-11-2021

**PROGRAM REPORT**

**Name of the Add on Course:** Design of Smart Antenna Systems and its Importance

**Day/Duration:** 32 hours

**Time:** 4:00pm to 5:00pm

**Resource Person:** Mr.A.Venkat Reddy, Elegant Embedded Solutions Pvt.Ltd, Hyderabad.

**Name of the Coordinator:** Mr.G.Ganesh Reddy,Assistant professor,VMTW, Hyderabad.

**Number of the Participants:** 90

**Topics covered:** The following topics covered in this program

- Smart Antennas
- Simulation of Smart Antennas

**Course Outcomes:**

COs	At the end of the course, students will have the ability to:	POs Mapped	Strength of mapping
CO1	Introduction of Smart Antennas	PO2,PO5	3
CO2	Integration and Simulation of Smart Antennas	PO4,PO3	2
CO3	Study the principles of frequency independent antenna design	PO2,PO4,PO6	3
CO4	Analyze and synthesize array antennas and also know the concepts of Smart antennas	PO4,PO7	1

**Assessment Procedure:** The assessment of the Add on course is conducted in Multiple Choice Questions through offline Mode.

  
**COORDINATOR**  
Vignans Institute of Management & Technology for Women  
Kondapur (V), Ghalkesar (M), Medchal - Malkajgiri (D) - 501 301  
T.S.

  
**PRINCIPAL**  
Vignans Institute of Management & Technology For Women  
Kondapur(V), Ghalkesar(M), Medchal-Malkajgiri(D)-501301  
Telangana State

  
**HOD**  
Head of the Department  
Electronics and Communication Engineering  
Vignans Institute of Management & Technology For Women  
Kondapur (V), Ghalkesar (M), Medchal-Malkajgiri (D) - 501 301



# VIGNAN'S INSTITUTE OF MANAGEMENT AND TECHNOLOGY FOR WOMEN

(Sponsored by Lavu Educational Society)

Approved by AICTE, New Delhi & Affiliated to JNTUH, Hyderabad.

Kondapur (V), Ghatkesar (M), Medchal - Malkajgiri (D) - 501 301



ELEGANT EMBEDDED SOLUTIONS PVT. LTD.

## Certificate of Course Completion

This is to certify that

G. SHIRISHA

has successfully completed the Value Added course on **"DESIGN OF SMART ANTENNA SYSTEMS AND ITS IMPORTANCE"** held from **17-09-2021** to **02-11-2021**, Organized by the Department of Electronics and Communication Engineering, in association with **ELEGANT EMBEDDED**

**SOLUTIONS PVT. LTD., Hyderabad.**

  
Co-ordinator



  
HoD, ECE  
Head of the Department

  
PRINCIPAL  
Vignans Institute of Management & Technology For Women  
Kondapur(V), Ghatkesar(M), Medchal-Malkajgiri(D)-501301  
Telangana State  
  
Principal, VMTW  
PRINCIPAL

Vignans Institute of Management & Technology For Women  
Kondapur(V), Ghatkesar(M), Medchal-Malkajgiri(D)-501301  
Telangana State



**DEPARTMENT OF ELECTRONICS AND COMMUNICATION ENGINEERING**

**VMTW/ECE/AOC/CIR/2019-20/I/01**

**Date : 07-09-2019**

**CIRCULAR**

This is to inform all the IV B. Tech ECE students that there will be an Add on course on "Latest developments in microwave antenna design and its Applications" in association with Elegant embedded solutions PVT LTD., Hyderabad, on 26-08-2019 to 12-11-2019. All the students are invited to take part in this course. The participating students will be honored with certificates of participation. During the course you will be encouraged to interact with the speaker and the other participants through the case study discussions.

**HOD**

**Head of the Department**  
Electronics and Communication Engineering  
Vignani's Institute of Management and Technology For Women  
Kondapur (V), Ghatkesar (M), A.R. Drai-501301

Copy to

The Principal, for kind information

IQAC

Notice board

IV.B.Tech students

Dept. file



**PRINCIPAL**  
Vignani's Institute of Management & Technology For Women  
Kondapur(V),Ghatkesar(M),Medchal-Malkajgiri(D)-501301  
Telangana State

## ABOUT THE COURSE

This course is devoted to address the need to enhance the knowledge about the Antenna design and the latest development pertaining to RF and Microwave circuits. This Program is designed for all engineering disciplines. This niche program particularly aims to impart these quintessential skills to the participants. Antenna engineering is a fast-growing field of communication concerned with the study and design of different type of antennas for various applications. The participants will be trained with hands-on approach to have an in-depth insight into the domain of communication and expose them to Feasibility & future scope.

## COURSE OBJECTIVES

- Microwave devices and circuits
- Satellite communications
- Microstrip & CPW antennas
- Implantable Antennas
- MW antennas by using SIW technology
- Reconfigurable planar antenna design and simulation methodology
- Wearable UWB Antennas for body area network
- Metamaterial
- Millimetre wave and sub millimetre-wave technologies
- Smart & MIMO antenna design
- Antenna parameters and design considerations
- MM Wave/THz Integrated Circuits
- EMI/EMC

## EXPECTED OUTCOMES

At the end of Workshop, participants will be able to

- Have an in-depth knowledge on Microwave devices and circuits & Satellite communications.
- Have an in-depth knowledge on Micro strip & CPW antennas, Implantable Antennas.
- Have an in-depth knowledge on Reconfigurable planar antenna design and simulation methodology.
- Working with Wearable UWB Antennas for body area network, Millimeter wave and sub millimeter-wave technologies.
- Working with Smart & MIMO antenna design, Antenna parameters and design considerations.



Resource Person:

**Mr. A. Venkat Reddy,**  
Sr. Senior Engineer,  
Elegant Embedded Solutions.

Co-ordinator:

**Mr. J. Sunil Kumar,**  
Assistant Professor,  
Department of ECE,  
Contact No: +91 83747 17668

LAST DATE FOR REGISTRATION: 24<sup>TH</sup> AUG, 2019

# VIGNAN'S

## INSTITUTE OF MANAGEMENT AND TECHNOLOGY FOR WOMEN

(Sponsored by Lavu Educational Society)  
Approved by AICTE, New Delhi & Affiliated to JNTU/H, Hyderabad.  
Kondapur (V), Ghatkesar (M), Medchal - Malkajgiri (D) - 501 301

ADD-ON COURSE ON  
**"LATEST DEVELOPMENT  
IN MICROWAVE  
ANTENNA DESIGN AND  
ITS APPLICATIONS"**  
26<sup>TH</sup> AUG TO 12<sup>TH</sup> NOV, 2019

  
PRINCIPAL

Vignan's Institute of Management & Technology For Women  
Kondapur(V), Ghatkesar(M), Medchal-Malkajgiri(D), 501301  
In Collaboration with:  
Telangana State



ELEGANT EMBEDDED SOLUTIONS PVT. LTD

Duration of the Course : 35 Hrs

Venue:  
**'B'-BLOCK SEMINAR HALL, VMTW**

Organized by:  
**DEPARTMENT OF ELECTRONICS AND  
COMMUNICATION ENGINEERING**



## DEPARTMENT OF ELECTRONICS AND COMMUNICATION ENGINEERING

**ADD ON COURSE NAME:** Latest Developments in Microwave Antenna Design and Its Applications

**Academic Year:** 2019-20

**Date:** 21-08-2019

**B.Tech IV-I SEM**

**DAY WISE SCHEDULE SHEET**

**SECTION:** ECE-A&B

**Room number:** BFF6

S.no	DAY	Topic	Timings	Duration
1.	26-08-19	Antenna Theory	04:00pm to 05:00pm	1 hour
2.	27-08-19	Antennas Introduction	04:00pm to 05:00pm	1 hour
3.	28-08-19	Radiation concept	04:00pm to 05:00pm	1 hour
4.	29-08-19	Types of Antennas	04:00pm to 05:00pm	1 hour
5.	30-08-19	Antenna parameters	04:00pm to 05:00pm	1 hour
6.	31-08-19	Friis Transmission equation	04:00pm to 05:00pm	1 hour
7.	01-09-19	Aperture Antenna	04:00pm to 05:00pm	1 hour
8.	02-09-19	Aperture Antenna : Introduction	04:00pm to 05:00pm	1 hour
9.	03-09-19	Pyramidal Horns	04:00pm to 05:00pm	1 hour
10.	04-09-19	Design Procedure	04:00pm to 05:00pm	1 hour
11.	05-09-19	Conical and Corrugated Horns	04:00pm to 05:00pm	1 hour
12.	06-09-19	Aperture Corrugated Horns	04:00pm to 05:00pm	1 hour
13.	07-09-19	Reflected Antennas	04:00pm to 05:00pm	1 hour
14.	09-09-19	Reflected Antennas :Parameters	04:00pm to 05:00pm	1 hour
15.	11-09-19	Analysis of front-fed parabolic	04:00pm to 05:00pm	1 hour
16.	13-09-19	Feed methods and feed types	04:00pm to 05:00pm	1 hour
17.	16-09-19	Cassegrain Reflector Horns.	04:00pm to 05:00pm	1 hour
18.	17-09-19	Microstrip Radiators	04:00pm to 05:00pm	1 hour
19.	18-09-19	Introduction	04:00pm to 05:00pm	1 hour
20.	19-09-19	Rectangular Antenna Design	04:00pm to 05:00pm	1 hour
21.	20-09-19	Circular $\mu$ strip Antenna Analysis and Design	04:00pm to 05:00pm	1 hour
22.	23-09-19	Microstrip Slot Antennas	04:00pm to 05:00pm	1 hour
23.	24-09-19	Wave guide fed slots	04:00pm to 05:00pm	1 hour
24.	25-09-19	Radiation mechanism	04:00pm to 05:00pm	1 hour
25.	26-09-19	Micro strip slot antennas	04:00pm to 05:00pm	1 hour
26.	27-09-19	Introduction to rectangular slot	04:00pm to 05:00pm	1 hour
27.	01-10-19	Narrow, wide	04:00pm to 05:00pm	1 hour
28.	03-10-19	Tapered and circularly polarized slot	04:00pm to 05:00pm	1 hour
29.	04-10-19	Annular slot antennas	04:00pm to 05:00pm	1 hour
30.	01-11-19	Comparison of microstrip slot	04:00pm to 05:00pm	1 hour
31.	04-11-19	Micro Strip Antenna Arrays	04:00pm to 05:00pm	1 hour



*Vignans*  
PRINCIPAL  
Vignans Institute of Management & Technology For Women  
Kondapur(V), Ghatkesar(M), Medchal-Malkajgiri(D)-501301  
Telangana State

32.	05-11-19	Characteristics of fixed beam linear	04:00pm to 05:00pm	1 hour
33.	06-11-19	Time delay scanning	04:00pm to 05:00pm	1 hour
34.	12-11-19	Advantage and disadvantages of	04:00pm to 05:00pm	1 hour
35.	12-11-19	Test conducted & feedback Taken	04:00pm to 05:00pm	1 hour
<b>Total 35 hours</b>				

  
COORDINATOR

  
ECE

Head of the Department  
Electronics and Communication – (B.Tech)  
Vignans Institute of Management and Technology for Women  
Kondapur (V), Ghatsiesar (M), Medchal-Malkajgiri (Dt), 501301, Tel.



  
PRINCIPAL  
Vignans Institute of Management & Technology For Women  
Kondapur(V),Ghatsiesar(M),Medchal-Malkajgiri(Dt)-501301  
Telangana State





DEPARTMENT OF ELECTRONICS AND COMMUNICATION ENGINEERING

ADD ON COURSE NAME: Latest Developments in Microwave Antenna Design And Its Applications

Academic Year: 2019-20

Date: 22-08-2019

B.Tech IV-I SEM

STUDENTS REGISTRATION FORM

SECTION: ECE-A

S.No	Roll number	Name of the student	Signature
1.	16UP1A0401	ALLIAMPALLI RISHITHA	Rishitha
2.	16UP1A0402	ANNAPUREDDY DEEPTHI	Deepti
3.	16UP1A0403	APPALAREDDY TEJASHWINI	A. Tejashwini
4.	16UP1A0404	AKI SOWMYA	Sowmya
5.	16UP1A0405	BALLIKONDA RUTHVIKA	Ruthvika
6.	16UP1A0407	DACHEPALLI NAGA SHARANYA	Sharanya
7.	16UP1A0408	DONTHU ALEKHYA	Alekhy
8.	16UP1A0409	DORAM MEGHANA	Meghana
9.	16UP1A0410	GAJALA SHANTHI SRI	Shanthi Sri
10.	16UP1A0412	GARSHA RAJITHA	Rajitha
11.	16UP1A0413	GOURIBATLA SRILEKHA	Srilekha
12.	16UP1A0414	GUTHA SUMAREDDY	Suma
13.	16UP1A0415	JAGTAP SRIVIDYA	S. Srividya
14.	16UP1A0416	JANUMPALLY SANGEETHA	Sangeetha
15.	16UP1A0417	K NEELA VENKATA SRIYA	V. Sriya
16.	16UP1A0418	K SHIVA POOJA	Pooja
17.	16UP1A0419	KAKI AKANKSHA	Akanksha
18.	16UP1A0420	KANUKUNTLA AMULYA	
19.	16UP1A0422	KEESARI AKSHITHA	Akshitha
20.	16UP1A0423	KOLAGANI KEERTHI	Keerthi
21.	16UP1A0424	KONTHAM MANASWINI	Manasa
22.	16UP1A0425	KORATUR RAJESWARI	Rajeshwari
23.	16UP1A0426	KOTI SRI SAI LALITHA SARANYA	Sai Saranya
24.	16UP1A0427	LAKUMARAPU SAI SREEJA	Sai Sreeja
25.	16UP1A0428	LINGAPURAM SRAVANI	Sravani
26.	16UP1A0430	MAHESHWARAM CHANDRIKA	Chandrika
27.	16UP1A0431	MALLOJALA PRANAVI	Pranavi
28.	16UP1A0432	MARRI RAJESHWARI	Rajeshwari
29.	16UP1A0434	MUTYALA SINDHUJA	Sindhuj
30.	16UP1A0435	N NISHA REDDY	Nisha
31.	16UP1A0436	NANDINI KANIKE	Kanika
32.	16UP1A0437	NERALLAPALLI RAVALIKA	Ravali
33.	16UP1A0438	P NARMADA	P. Narmada
34.	16UP1A0439	PELIMELLI HARIKA	Hari
35.	16UP1A0440	PENDYALA SHARANYA	Sharanya



*[Signature]*  
PRINCIPAL

Vignans Institute of Management & Technology For Women  
Kondapur(V), Ghatkesar(M), Medchal-Malkajgiri(D)-501301  
Telangana State

36.	16UPIA0441	PIGILAM LIKITHA	Likitha
37.	16UPIA0442	PULLURI MOUNIKA	Mounika
38.	16UPIA0443	RAMAGIRI VISHALI LAXMI	Vishali
39.	16UPIA0445	SAVA SRAVANI	Sravani
40.	16UPIA0446	SHIKA MANIDEEPA	S Manideepa
41.	16UPIA0447	UDATA KAVERI KOMRAIYA	K. Udata
42.	16UPIA0448	VALISETTY SUSHMA	V. Sushma

  
COORDINATOR

  
HOD

Head of the Department  
Electronics and Communication Engineering  
Vignn's Institute of Management and Technology  
Kondapur (V), Ghatkesar (M), R.R. Dist-501301



  
PRINCIPAL

Vignn's Institute of Management & Technology For Women  
Kondapur(V), Ghatkesar(M), Medchal-Malkajgiri(DI)-501301  
Telangana State



DEPARTMENT OF ELECTRONICS AND COMMUNICATION ENGINEERING

ADD ON COURSE NAME: Latest Developments in Microwave Antenna Design and Its Applications

Academic Year: 2019-20

Date: 22-08-2019

B.Tech IV-I SEM

STUDENTS REGISTERED LIST

SECTION: ECE-A

S.No	Roll number	Name of the student
1.	16UP1A0401	ALLIAMPALLI RISHITHA
2.	16UP1A0402	ANNAPUREDDY DEEPTHI
3.	16UP1A0403	APPALAREDDY TEJASHWINI
4.	16UP1A0404	BAKI SOWMYA
5.	16UP1A0405	BALLIKONDA RUTHVIKA
6.	16UP1A0407	DACHEPALLI NAGA SHARANYA
7.	16UP1A0408	DONTHU ALEKHYA
8.	16UP1A0409	DORAM MEGHANA
9.	16UP1A0410	GAJALA SHANTHI SRI
10.	16UP1A0412	GARSHA RAJITHA
11.	16UP1A0413	GOURIBATLA SRILEKHA
12.	16UP1A0414	GUTHA SUMAREDDY
13.	16UP1A0415	JAGTAP SRIVIDYA
14.	16UP1A0416	JANUMPALLY SANGEETHA
15.	16UP1A0417	K NEELA VENKATA SRIYA
16.	16UP1A0418	K SHIVA POOJA
17.	16UP1A0419	KAKI AKANKSHA
18.	16UP1A0422	KEESARI AKSHITHA
19.	16UP1A0423	KOLAGANI KEERTHI
20.	16UP1A0424	KONTHAM MANASWINI
21.	16UP1A0425	KORATUR RAJESWARI
22.	16UP1A0426	KOTI SRI SAI LALITHA SARANYA
23.	16UP1A0427	LAKUMARAPU SAI SREEJA
24.	16UP1A0428	LINGAPURAM SRAVANI
25.	16UP1A0430	MAHESHWARAM CHANDRIKA
26.	16UP1A0431	MALLOJJALA PRANAVI
27.	16UP1A0432	MARRI RAJESHWARI
28.	16UP1A0434	MUTYALA SINDHUJA
29.	16UP1A0435	N NISHA REDDY
30.	16UP1A0436	NANDINI KANIKE
31.	16UP1A0437	NERALLAPALLI RAVALIKA
32.	16UP1A0438	P NARMADA
33.	16UP1A0439	PELIMELLI HARIKA
34.	16UP1A0440	PENDYALA SHARANYA
35.	16UP1A0441	PIGILAM LIKITHA



*[Signature]*  
PRINCIPAL

Vignan's Institute of Management & Technology For Women  
Kondapur (V), Ghatkesar (M), Medchal-Malkajgiri (D)-501301  
Telangana State

36.	16UPIA0442	PULLURI MOUNIKA
37.	16UPIA0443	RAMAGIRI VISHALI LAXMI
38.	16UPIA0445	SAVA SRAVANI
39.	16UPIA0446	SHIKA MANIDEEPA
40.	16UPIA0447	UDATA KAVERI KOMRAIYA
41.	16UPIA0448	VALISETTY SUSHMA

  
COORDINATOR

  
HOD

Head of the Department  
Electronics and Communication Engineering  
Tigra's Institute of Management and Technology for Women  
Kondapur (V), Ghatkesar (M), R.R. Dist-501 301





PRINCIPAL  
Tigra's Institute of Management & Technology for Women  
Kondapur(V),Ghatkesar(M),Medchal-Malkajiri(DI)-501301  
Telangana State



DEPARTMENT OF ELECTRONICS AND COMMUNICATION ENGINEERING

ADD ON COURSE NAME: Latest Developments in Microwave Antenna Design and Its Applications

Academic Year: 2019-20

Date: 22-08-2019

B.Tech IV-I SEM

STUDENTS REGISTRATION FORM

SECTION: ECE-B

S.No	Roll number	Name of the student	Signature
1.	16UP1A0449	A LAXMI PRIYA	Laxmi Priya
2.	16UP1A0451	AKKAPEDDI SAI SIRISHA	Sirisha
3.	16UP1A0453	BARLA REKHA	Rekha
4.	16UP1A0454	BIROJU SUCHITHRA	Suchithra
5.	16UP1A0455	BONAGA USHA RANI	Usha Rani
6.	16UP1A0457	BOOSA DIVYA	Divya
7.	16UP1A0458	CHENNURI DHARANI	Dharani
8.	16UP1A0459	CHERIALA SWARNALATHA	Swarnalatha
9.	16UP1A0460	CHOPPADHANDI SUPRIYA	Supriya
10.	16UP1A0461	D SRI PRAJNA	Sri Prajna
11.	16UP1A0462	EMMADI NIKITHA	Nikitha
12.	16UP1A0463	G RAVALI	Ravali
13.	16UP1A0464	GODUGU SOWMYA	Sowmya
14.	16UP1A0465	GOVINDU SHIVANI	Shivani
15.	16UP1A0466	K S KEERTHANA	Keerthana
16.	16UP1A0467	KARNE NEELIMA	Neelima
17.	16UP1A0468	KOLA KEERTHANA	Keerthana
18.	16UP1A0469	KORIPADU ANITHA DEVI	Anitha
19.	16UP1A0470	KORIVI HARIKA	Harika
20.	16UP1A0471	MADHAVARAM BHAVANI	Bhavani
21.	16UP1A0472	MANDALA SUPRIYA	Supriya
22.	16UP1A0473	MANNEM SWETHA	Swetha
23.	16UP1A0474	MURALA DHARANI	Dharani
24.	16UP1A0475	N V SAI MEGHALA	Meghala
25.	16UP1A0476	NALLAN VINAYITA	Vinayita
26.	16UP1A0477	NEHA HUSSAIN	Neha
27.	16UP1A0478	NISHI KUMARI	Kumari
28.	16UP1A0479	NUNEMUNTHALA TEJASHWINI	Tejashwini
29.	16UP1A0481	PALVAI SWETHA REDDY	Swetha
30.	16UP1A0482	PATCHARLA TULASI	Tulasi
31.	16UP1A0483	POTHUNURI SATHVIKA	Sathvika
32.	16UP1A0484	RACHAKONDA SRIKALAMADHURI	Madhuri
33.	16UP1A0485	RAJABOINA SOUMYA	Soumya
34.	16UP1A0486	RAMIYA RAMESH SINGARWENI	Singarwani



*(Handwritten Signature)*

PRINCIPAL

Vignans Institute of Management & Technology For Women  
Kondapur(V), Ghatkesar(M), Medchal-Malkajgiri(D)-501301  
Telangana State

35.	16UPIA0487	SAMPATHI NAVYA	Navya
36.	16UPIA0488	SANALA SWARNASRI	Swarna
37.	16UPIA0489	SEETHA VAISHNAVI CHAVALI	S. Vaishnavi-Chavali
38.	16UPIA0490	SREE VINDYA R	Vindya
39.	16UPIA0492	UPPALA PRAVALIKA	Pravalika
40.	16UPIA0493	VELUGALA UMARANI	Umarani
41.	16UPIA0494	VEMPATI NIKITHA SHARMA	Nikitha
42.	16UPIA0495	VUNDYALA NIKITHA	Nikitha

  
COORDINATOR

  
HOD

Head of the Department  
Electronics and Communication Engineering  
Vignans Institute of Management and Technology For Women  
Kondapur (V), Ghatkesar (M), R.R. Dist-501 501



  
PRINCIPAL  
Vignans Institute of Management & Technology For Women  
Kondapur(V), Ghatkesar(M), Medchal-Malkajgiri(DI)-501 501  
Telangana State



**DEPARTMENT OF ELECTRONICS AND COMMUNICATION ENGINEERING**

**ADD ON COURSE NAME:** Latest Developments in Microwave Antenna Design and Its Applications

**Academic Year:** 2019-20

**Date:** 22-08-2019

**B.Tech IV-I SEM**

**STUDENTS REGISTERED LIST**

**SECTION:** ECE-B

S.No	Roll number	Name of the student
1.	16UP1A0449	A LAXMI PRIYA
2.	16UP1A0451	AKKAPEDDI SAI SIRISHA
3.	16UP1A0453	BARLA REKHA
4.	16UP1A0454	BIROJU SUCHITHRA
5.	16UP1A0455	BONAGA USHA RANI
6.	16UP1A0457	BOOSA DIVYA
7.	16UP1A0458	CHENNURI DHARANI
8.	16UP1A0459	CHERIALA SWARNALATHA
9.	16UP1A0460	CHOPPADHANDI SUPRIYA
10.	16UP1A0461	D SRI PRAJNA
11.	16UP1A0462	EMMADI NIKITHA
12.	16UP1A0463	G RAVALI
13.	16UP1A0464	GODUGU SOWMYA
14.	16UP1A0465	GOVINDU SHIVANI
15.	16UP1A0466	K S KEERTHANA
16.	16UP1A0467	KARNE NEELIMA
17.	16UP1A0468	KOLA KEERTHANA
18.	16UP1A0469	KORIPADU ANITHA DEVI
19.	16UP1A0470	KORIVI HARIKA
20.	16UP1A0471	MADHAVARAM BHAVANI
21.	16UP1A0472	MANDALA SUPRIYA
22.	16UP1A0473	MANNEM SWETHA
23.	16UP1A0474	MURALA DHARANI
24.	16UP1A0475	N V SAI MEGHALA
25.	16UP1A0476	NALLAN VINAYITA
26.	16UP1A0477	NEHA HUSSAIN
27.	16UP1A0478	NISHI KUMARI
28.	16UP1A0479	NUNEMUNTHALA TEJASHWINI
29.	16UP1A0481	PALVAI SWETHA REDDY
30.	16UP1A0482	PATCHARLA TULASI
31.	16UP1A0483	POTHUNURI SATHVIKA
32.	16UP1A0484	RSRIKALAMADHURI
33.	16UP1A0485	RAJABOINA SOUMYA
34.	16UP1A0486	RAMIYA RAMESH SINGARWENI
35.	16UP1A0487	SAMPATHI NAVYA



*(Signature)*  
PRINCIPAL

Vignans Institute of Management & Technology For Women  
Kondapur(V), Ghatkesar(M), Medchal-Malkajgiri(D)-501301  
Telangana State

36.	16UPIA0488	SANALA SWARNASRI
37.	16UPIA0489	SEETHA VAISHNAVI CHAVALI
38.	16UPIA0490	SREE VINDYA R
39.	16UPIA0492	UPPALA PRAVALIKA
40.	16UPIA0493	VELUGALA UMARANI
41.	16UPIA0494	VEMPATI NIKITHA SHARMA
42.	16UPIA0495	VUNDYALA NIKITHA

  
COORDINATOR

  
HOD

Head of the Department  
Electronics and Communications Engineering,  
Ygnan's Institute of Management and Technology for Women  
Kondapur (V), Ghatkesar (M), R.R. Dist-501 301



  
PRINCIPAL

Ygnan's Institute of Management & Technology For Women  
Kondapur(V), Ghatkesar(M), Medchal-Malkajgiri(Dist)-501 301  
Telangana State





**DEPARTMENT OF ELECTRONICS AND COMMUNICATION ENGINEERING**

**ADD ON COURSE NAME:** Latest Developments in Microwave Antenna Design and Its Applications

**Academic Year:** 2019-20

**Date:** 26-08-2019

**B.Tech IV-I SEM**

**DAY WISE ATTENDANCE SHEET**

**SECTION:** ECE-A

S.No	Roll number	26-08-19	27-08-19	28-08-19	29-08-19	30-08-19
1.	16UPIA0401	Rishitha	Rishitha	Rishitha	Rishitha	Rishitha
2.	16UPIA0402	Deepthi	Deepthi	Deepthi	Deepthi	Deepthi
3.	16UPIA0403	A. Tejashwini	A. Tejashwini	A. Tejashwini	A. Tejashwini	A. Tejashwini
4.	16UPIA0404	Sai	Sai	Sai	Sai	Sai
5.	16UPIA0405	Rulthika	Rulthika	Rulthika	Rulthika	Rulthika
6.	16UPIA0407	sharanya	sharanya	sharanya	sharanya	sharanya
7.	16UPIA0408	Alekhya	Alekhya	Alekhya	Alekhya	Alekhya
8.	16UPIA0409	Meghara	Meghara	Meghara	Meghara	Meghara
9.	16UPIA0410	Shanthi Sri	Shanthi Sri	Shanthi Sri	Shanthi Sri	Shanthi Sri
10.	16UPIA0412	G.Raj	G.Raj	G.Raj	G.Raj	G.Raj
11.	16UPIA0413	Sailekha	Sailekha	Sailekha	Sailekha	Sailekha
12.	16UPIA0414	Suma	Suma	Suma	Suma	Suma
13.	16UPIA0415	S.Srinidha	S.Srinidha	S.Srinidha	S.Srinidha	S.Srinidha
14.	16UPIA0416	Sangeetha	Sangeetha	Sangeetha	Sangeetha	Sangeetha
15.	16UPIA0417	V. Sriyay	V. Sriyay	V. Sriyay	V. Sriyay	V. Sriyay
16.	16UPIA0418	pooja	pooja	pooja	pooja	pooja
17.	16UPIA0419	Arunika	Arunika	Arunika	Arunika	Arunika
18.	16UPIA0422	Aksh	Aksh	Aksh	Aksh	Aksh
19.	16UPIA0423	Keerthi	Keerthi	Keerthi	Keerthi	Keerthi
20.	16UPIA0424	Manas	Manas	Manas	Manas	Manas
21.	16UPIA0425	Raj	Raj	Raj	Raj	Raj
22.	16UPIA0426	Saranya	Saranya	Saranya	Saranya	Saranya
23.	16UPIA0427	Sai	Sai	Sai	Sai	Sai
24.	16UPIA0428	Sravani	Sravani	Sravani	Sravani	Sravani
25.	16UPIA0430	Charvika	Charvika	Charvika	Charvika	Charvika
26.	16UPIA0431	Pranavi	Pranavi	Pranavi	Pranavi	Pranavi
27.	16UPIA0432	Raj	Raj	Raj	Raj	Raj
28.	16UPIA0434	Sindhya	Sindhya	Sindhya	Sindhya	Sindhya
29.	16UPIA0435	Nidhat	Nidhat	Nidhat	Nidhat	Nidhat
30.	16UPIA0436	Kanika	Kanika	Kanika	Kanika	Kanika
31.	16UPIA0437	Ravali	Ravali	Ravali	Ravali	Ravali
32.	16UPIA0438	P. Anamada	P. Anamada	P. Anamada	P. Anamada	P. Anamada
33.	16UPIA0439	Prat	Prat	Prat	Prat	Prat
34.	16UPIA0440	sharanya	sharanya	sharanya	sharanya	sharanya



**PRINCIPAL**

Vignans Institute of Management & Technology for Women  
Kondapur(V), Ghatkesar(M), Medchal-Malkajgiri(D) - 501 301  
Telangana State

35.	16UPIA0441	<del>Lakshya</del>	<del>Lakshya</del>	<del>Lakshya</del>	<del>Lakshya</del>	<del>Lakshya</del>
36.	16UPIA0442	<del>Mounika</del>	<del>Mounika</del>	<del>Mounika</del>	<del>Mounika</del>	<del>Mounika</del>
37.	16UPIA0443	<del>Vaib</del>	<del>Vaib</del>	<del>Vaib</del>	<del>Vaib</del>	<del>Vaib</del>
38.	16UPIA0445	<del>Saavani</del>	<del>Saavani</del>	<del>Saavani</del>	<del>Saavani</del>	<del>Saavani</del>
39.	16UPIA0446	S. Manideepa	S. Manideepa	S. Manideepa	S. Manideepa	S. Manideepa
40.	16UPIA0447	K.R.	K.R.	K.R.	K.R.	K.R.
41.	16UPIA0448	V. Sushma	V. Sushma	V. Sushma	V. Sushma	V. Sushma

  
COORDINATOR

  
HOD

Head of the Department  
Electronics and Communication Engineer-  
Vignans Institute of Management and Technology For Women  
Kondapur (V), Ghatkesar (M), R.R. Dist-501301



  
PRINCIPAL  
Vignans Institute of Management & Technology For Women  
Kondapur(V), Ghatkesar(M), Medchal-Malkajgiri(Dt)-501301  
Telangana State



**DEPARTMENT OF ELECTRONICS AND COMMUNICATION ENGINEERING**

**ADD ON COURSE NAME:** Latest Developments in Microwave Antenna Design and Its Applications

**Academic Year:** 2019-20

**Date:** 26-08-2019

**B.Tech IV-I SEM**

**DAY WISE ATTENDANCE SHEET**

**SECTION:** ECE-B

S.No	Roll number	26-08-19	27-08-19	28-08-19	29-08-19	30-08-19
1.	16UPIA0449	Laxmi Priya	Laxmi Priya	Laxmi Priya	Laxmi Priya	Laxmi Priya
2.	16UPIA0451	Srisitha	Srisitha	Srisitha	Srisitha	Srisitha
3.	16UPIA0453	Rakhee	Rakhee	Rakhee	Rakhee	Rakhee
4.	16UPIA0454	Suchita	Suchita	Suchita	Suchita	Suchita
5.	16UPIA0455	(P)	(P)	(P)	(P)	(P)
6.	16UPIA0457	Dipti	Dipti	Dipti	Dipti	Dipti
7.	16UPIA0458	Dharani	Dharani	Dharani	Dharani	Dharani
8.	16UPIA0459	S.Suvarnalatha	S.Suvarnalatha	S.Suvarnalatha	S.Suvarnalatha	S.Suvarnalatha
9.	16UPIA0460	Supriya	Supriya	Supriya	Supriya	Supriya
10.	16UPIA0461	Sri Pragna	Sri Pragna	Sri Pragna	Sri Pragna	Sri Pragna
11.	16UPIA0462	Nikitha	Nikitha	Nikitha	Nikitha	Nikitha
12.	16UPIA0463	Ravali	Ravali	Ravali	Ravali	Ravali
13.	16UPIA0464	Sourya	Sourya	Sourya	Sourya	Sourya
14.	16UPIA0465	Shivani	Shivani	Shivani	Shivani	Shivani
15.	16UPIA0466	Kul	Kul	Kul	Kul	Kul
16.	16UPIA0467	Neelima	Neelima	Neelima	Neelima	Neelima
17.	16UPIA0468	Karthika	Karthika	Karthika	Karthika	Karthika
18.	16UPIA0469	Anitha	Anitha	Anitha	Anitha	Anitha
19.	16UPIA0470	Hastika	Hastika	Hastika	Hastika	Hastika
20.	16UPIA0471	Jayanthi	Jayanthi	Jayanthi	Jayanthi	Jayanthi
21.	16UPIA0472	Supriya	Supriya	Supriya	Supriya	Supriya
22.	16UPIA0473	H.Saritha	H.Saritha	H.Saritha	H.Saritha	H.Saritha
23.	16UPIA0474	Charan	Charan	Charan	Charan	Charan
24.	16UPIA0475	Meghana	Meghana	Meghana	Meghana	Meghana
25.	16UPIA0476	Vinayita	Vinayita	Vinayita	Vinayita	Vinayita
26.	16UPIA0477	Neha	Neha	Neha	Neha	Neha
27.	16UPIA0478	Kumari	Kumari	Kumari	Kumari	Kumari
28.	16UPIA0479	Teju	Teju	Teju	Teju	Teju
29.	16UPIA0481	Saritha	Saritha	Saritha	Saritha	Saritha
30.	16UPIA0482	P. Tulasi	P. Tulasi	P. Tulasi	P. Tulasi	P. Tulasi
31.	16UPIA0483	Sath	Sath	Sath	Sath	Sath
32.	16UPIA0484	Madhuri	Madhuri	Madhuri	Madhuri	Madhuri
33.	16UPIA0485	Soumya	Soumya	Soumya	Soumya	Soumya
34.	16UPIA0486	Singa	Singa	Singa	Singa	Singa
35.	16UPIA0487	Navya	Navya	Navya	Navya	Navya



*(Signature)*  
PRINCIPAL

Vignani's Institute of Management & Technology For Women  
Kondapur(V), Ghathkesar(M), Medchal-Malkajgiri(DI)-501 301  
Telangana State

36.	16UPIA0488	Suvarna	Suvarna	Suvarna	Suvarna	Suvarna
37.	16UPIA0489	S. Vanshraj Chavali	S. Vanshraj Chavali	S. Vanshraj Chavali	S. Vanshraj Chavali	S. Vanshraj Chavali
38.	16UPIA0490	Vindya	Vindya	Vindya	Vindya	Vindya
39.	16UPIA0492	Pravali	Pravali	Pravali	Pravali	Pravali
40.	16UPIA0493	Umasani	Umasani	Umasani	Umasani	Umasani
41.	16UPIA0494	Nikitha	Nikitha	Nikitha	Nikitha	Nikitha
42.	16UPIA0495	Nikitha	Nikitha	Nikitha	Nikitha	Nikitha

COORDINATOR

HOD

Head of the Department  
 Electronics and Communication Engineer  
 Vignaa's Institute of Management and Technology for Women  
 Kandapur (V), Ghatkesar (M), R.R. Dist-501 301



PRINCIPAL

Vignaa's Institute of Management & Technology For Women  
 Kandapur(V), Ghatkesar(M), Medchal-Malkajgiri(Dt)-501 301  
 Telangana State



**DEPARTMENT OF ELECTRONICS AND COMMUNICATION ENGINEERING**

**ADD ON COURSE NAME:** Latest Developments in Microwave Antenna Design and Its Applications

**Academic Year:** 2019-20

**Date:** 31-08-2019

**B.Tech IV-I SEM**

**DAY WISE ATTENDANCE SHEET**

**SECTION:** ECE-A

S.No	Roll number	31-08-19	01-09-19	02-09-19	03-09-19	04-09-19
1.	16UPIA0401	Rishitha	Rishitha	Rishitha	Rishitha	Rishitha
2.	16UPIA0402	Deepthi	Deepthi	Deepthi	Deepthi	Deepthi
3.	16UPIA0403	A. Tejashwini	A. Tejashwini	A. Tejashwini	A. Tejashwini	A. Tejashwini
4.	16UPIA0404	Gay	Gay	Gay	Gay	Gay
5.	16UPIA0405	Pallvika	Pallvika	Pallvika	Pallvika	Pallvika
6.	16UPIA0407	sharanya	sharanya	sharanya	sharanya	sharanya
7.	16UPIA0408	Alekhya	Alekhya	Alekhya	Alekhya	Alekhya
8.	16UPIA0409	Meghana	Meghana	Meghana	Meghana	Meghana
9.	16UPIA0410	-10	Shanthisri	Shanthisri	Shanthisri	Shanthisri
10.	16UPIA0412	G. Raj	G. Raj	G. Raj	G. Raj	G. Raj
11.	16UPIA0413	Sailekha	Sailekha	Sailekha	Sailekha	Sailekha
12.	16UPIA0414	Suma	Suma	Suma	Suma	Suma
13.	16UPIA0415	S. Srividya	S. Srividya	S. Srividya	S. Srividya	S. Srividya
14.	16UPIA0416	Sangeetha	Sangeetha	Sangeetha	Sangeetha	Sangeetha
15.	16UPIA0417	V. Sriyay	V. Sriyay	V. Sriyay	V. Sriyay	V. Sriyay
16.	16UPIA0418	Pooja	Pooja	Pooja	Pooja	Pooja
17.	16UPIA0419	Arunika	Arunika	Arunika	Arunika	Arunika
18.	16UPIA0422	Aksh	Aksh	Aksh	Aksh	Aksh
19.	16UPIA0423	Keerthi	Keerthi	Keerthi	Keerthi	Keerthi
20.	16UPIA0424	Manas	Manas	Manas	Manas	Manas
21.	16UPIA0425	Raj	Raj	Raj	Raj	Raj
22.	16UPIA0426	Saranya	Saranya	Saranya	Saranya	Saranya
23.	16UPIA0427	Sai	Sai	Sai	Sai	Sai
24.	16UPIA0428	Pravani	Pravani	Pravani	Pravani	Pravani
25.	16UPIA0430	Chandrika	Chandrika	Chandrika	Chandrika	AB
26.	16UPIA0431	Pranavi	Pranavi	Pranavi	Pranavi	Pranavi
27.	16UPIA0432	Prj.	Prj.	Prj.	Prj.	Prj.
28.	16UPIA0434	Sindhya	Sindhya	Sindhya	Sindhya	Sindhya
29.	16UPIA0435	Nishay	Nishay	Nishay	Nishay	Nishay
30.	16UPIA0436	Kalvika	Kalvika	Kalvika	Kalvika	Kalvika
31.	16UPIA0437	Ravali	Ravali	Ravali	Ravali	Ravali
32.	16UPIA0438	P. Prarmada	P. Prarmada	P. Prarmada	P. Prarmada	P. Prarmada
33.	16UPIA0439	Prj.	Prj.	Prj.	Prj.	Prj.
34.	16UPIA0440	Sharanya	Sharanya	Sharanya	Sharanya	Sharanya
35.	16UPIA0441	Lakshya	Lakshya	Lakshya	Lakshya	Lakshya



**PRINCIPAL**

Vignans Institute of Management & Technology For Women  
Kondapur(V), Ghatkesar(M), Medchal-Malkajgiri(D)-501301  
Telangana State

36.	16UP1A0442	Manika	Manika	Manika	Manika	Manika
37.	16UP1A0443	Vaif	Vaif	Vaif	Vaif	Vaif
38.	16UP1A0445	Saavani	Saavani	Saavani	Saavani	Saavani
39.	16UP1A0446	S.Manidepa	S.Manidepa	S.Manidepa	S.Manidepa	S.Manidepa
40.	16UP1A0447	Kul	Kul	Kul	Kul	Kul
41.	16UP1A0448	V.Sushma	V.Sushma	V.Sushma	V.Sushma	V.Sushma

  
COORDINATOR

  
ECE,HOD

Head of the Department  
Electronics and Communication Engineering  
Vignee's Institute of Management and Technology for Women  
Kondapur (V), Ghatkesar (M), R.R. Dist-501 301



  
PRINCIPAL  
Vignee's Institute of Management & Technology For Women  
Kondapur(V),Ghatkesar(M),Medchal-Malkajgiri(DT)-501301  
Telangana State



**DEPARTMENT OF ELECTRONICS AND COMMUNICATION ENGINEERING**

**ADD ON COURSE NAME:** Latest Developments in Microwave Antenna Design and Its Applications

**Academic Year:** 2019-20

**Date:** 31-08-2019

**B.Tech IV-I SEM**

**DAY WISE ATTENDANCE SHEET**

**SECTION:** ECE-B

S.No	Roll number	31-08-19	01-09-19	02-09-19	03-09-19	04-09-19
1.	16UPIA0449	Varani Priya	Varani Priya	Varani Priya	Varani Priya	Varani Priya
2.	16UPIA0451	Sriisha	Sriisha	Sriisha	Sriisha	Sriisha
3.	16UPIA0453	Rakha	Rakha	Rakha	Rakha	Rakha
4.	16UPIA0454	Suktha	Suktha	Suktha	Suktha	Suktha
5.	16UPIA0455	(P)	(P)	(P)	(P)	(P)
6.	16UPIA0457	Darya	Darya	Darya	Darya	Darya
7.	16UPIA0458	Dharani	Dharani	Dharani	Dharani	Dharani
8.	16UPIA0459	C.Sumanalatha	C.Sumanalatha	C.Sumanalatha	C.Sumanalatha	C.Sumanalatha
9.	16UPIA0460	Supriya	Supriya	Supriya	Supriya	Supriya
10.	16UPIA0461	W.SriPrajna	W.SriPrajna	W.SriPrajna	W.SriPrajna	W.SriPrajna
11.	16UPIA0462	Nikitha	Nikitha	Nikitha	Nikitha	Nikitha
12.	16UPIA0463	Ravali	Ravali	Ravali	Ravali	Ravali
13.	16UPIA0464	Sowmya	Sowmya	Sowmya	Sowmya	Sowmya
14.	16UPIA0465	Shivani	Shivani	Shivani	Shivani	Shivani
15.	16UPIA0466	Kriti	Kriti	Kriti	Kriti	Kriti
16.	16UPIA0467	Neelima	Neelima	Neelima	Neelima	Neelima
17.	16UPIA0468	Kaushika	Kaushika	Kaushika	Kaushika	Kaushika
18.	16UPIA0469	Anitha	Anitha	Anitha	Anitha	Anitha
19.	16UPIA0470	Jhalika	Jhalika	Jhalika	Jhalika	Jhalika
20.	16UPIA0471	Varadha	Varadha	Varadha	Varadha	Varadha
21.	16UPIA0472	Supriya	Supriya	Supriya	Supriya	Supriya
22.	16UPIA0473	M.Sowmya	M.Sowmya	M.Sowmya	M.Sowmya	M.Sowmya
23.	16UPIA0474	Charani	Charani	Charani	Charani	Charani
24.	16UPIA0475	Meghana	Meghana	Meghana	Meghana	Meghana
25.	16UPIA0476	Vinayita	Vinayita	Vinayita	Vinayita	Vinayita
26.	16UPIA0477	Neha	Neha	Neha	Neha	Neha
27.	16UPIA0478	Kumari	Kumari	Kumari	Kumari	Kumari
28.	16UPIA0479	Teju	Teju	Teju	Teju	Teju
29.	16UPIA0481	Smriti	Smriti	Smriti	Smriti	Smriti
30.	16UPIA0482	P.Tulasi	P.Tulasi	P.Tulasi	P.Tulasi	P.Tulasi
31.	16UPIA0483	Sathi	Sathi	Sathi	Sathi	Sathi
32.	16UPIA0484	Madhuri	Madhuri	Madhuri	Madhuri	Madhuri
33.	16UPIA0485	Sowmya	Sowmya	Sowmya	Sowmya	Sowmya
34.	16UPIA0486	Singal	Singal	Singal	Singal	Singal
35.	16UPIA0487	Navya	Navya	Navya	Navya	Navya



*[Signature]*  
PRINCIPAL

Vignans Institute of Management & Technology For Women  
Kondapur(V), Ghatkesar(M), Medchal-Malkajgiri(D)-501301  
Telangana State

36.	16UP1A0488	Swarna	Swarna	Swarna	Swarna	Swarna
37.	16UP1A0489	S. Vaishnavi Cherali	S. Vaishnavi Cherali	S. Vaishnavi Cherali	S. Vaishnavi Cherali	S. Vaishnavi Cherali
38.	16UP1A0490	Vandya	Vandya	Vandya	Vandya	Vandya
39.	16UP1A0492	Pravalika	Pravalika	Pravalika	Pravalika	Pravalika
40.	16UP1A0493	Umarant	Umarant	Umarant	Umarant	Umarant
41.	16UP1A0494	Nikitha	Nikitha	Nikitha	Nikitha	Nikitha
42.	16UP1A0495	Nikitha	Nikitha	Nikitha	Nikitha	Nikitha

  
**COORDINATOR**

  
**HOD**

Head of the Department  
 Electronics and Communication Engineer  
 Vignan's Institute of Management and Technology for Women  
 Kondapur (V), Ghatkesar (M), R.R. Dist-501 Ju.





**PRINCIPAL**  
 Vignan's Institute of Management & Technology For Women  
 Kondapur(V), Ghatkesar(M), Medchal-Malkajgiri(DE)-501301  
 Telangana State





**DEPARTMENT OF ELECTRONICS AND COMMUNICATION ENGINEERING**

**ADD ON COURSE NAME:** Latest Developments in Microwave Antenna Design and Its Applications

**Academic Year:** 2019-20

**Date:** 05-09-2019

**B.Tech IV-I SEM**

**DAY WISE ATTENDANCE SHEET**

**SECTION:** ECE-A

S.No	Roll number	05-09-19	06-09-19	07-09-19	09-09-19	11-09-19
1.	16UPIA0401	Rishitha	Rishitha	Rishitha	Rishitha	Rishitha
2.	16UPIA0402	Deepthi	Deepthi	Deepthi	Deepthi	Deepthi
3.	16UPIA0403	A. Tejeshwari	A. Tejeshwari	A. Tejeshwari	A. Tejeshwari	A. Tejeshwari
4.	16UPIA0404	Best	Best	Best	Best	Best
5.	16UPIA0405	Kulbika	Kulbika	Kulbika	Kulbika	Kulbika
6.	16UPIA0407	sharanya	sharanya	sharanya	sharanya	sharanya
7.	16UPIA0408	Dharani	Dharani	Dharani	Dharani	Dharani
8.	16UPIA0409	Meghana	Meghana	Meghana	Meghana	Meghana
9.	16UPIA0410	Shanithi Sai	Shanithi Sai	Shanithi Sai	Shanithi Sai	Shanithi Sai
10.	16UPIA0412	G.Raj	G.Raj	G.Raj	G.Raj	G.Raj
11.	16UPIA0413	Sailekha	Sailekha	Sailekha	Sailekha	Sailekha
12.	16UPIA0414	Suma	Suma	Suma	Suma	Suma
13.	16UPIA0415	J.srinidya	J.srinidya	J.srinidya	J.srinidya	J.srinidya
14.	16UPIA0416	Sangeetha	Sangeetha	Sangeetha	Sangeetha	Sangeetha
15.	16UPIA0417	V. Sriyaf	V. Sriyaf	V. Sriyaf	V. Sriyaf	V. Sriyaf
16.	16UPIA0418	Pooja	Pooja	Pooja	Pooja	Pooja
17.	16UPIA0419	Arunika	Arunika	Arunika	Arunika	Arunika
18.	16UPIA0422	AKW	AKW	AKW	AKW	AKW
19.	16UPIA0423	Keerthi	Keerthi	Keerthi	Keerthi	Keerthi
20.	16UPIA0424	Manas	Manas	Manas	Manas	Manas
21.	16UPIA0425	Raj	Raj	Raj	Raj	Raj
22.	16UPIA0426	Saranya	Saranya	Saranya	Saranya	Saranya
23.	16UPIA0427	Sai	Sai	Sai	Sai	Sai
24.	16UPIA0428	Pravani	Pravani	Pravani	Pravani	Pravani
25.	16UPIA0430	Chandrita	Chandrita	Chandrita	Chandrita	Chandrita
26.	16UPIA0431	Pranavi	Pranavi	Pranavi	Pranavi	Pranavi
27.	16UPIA0432	dy.	dy.	dy.	dy.	dy.
28.	16UPIA0434	sindhya	sindhya	sindhya	sindhya	sindhya
29.	16UPIA0435	Nishaf	Nishaf	Nishaf	Nishaf	Nishaf
30.	16UPIA0436	Kauke	Kauke	Kauke	Kauke	Kauke
31.	16UPIA0437	Ravali	Ravali	Ravali	Ravali	Ravali
32.	16UPIA0438	P.nirmala	P.nirmala	P.nirmala	P.nirmala	P.nirmala
33.	16UPIA0439	Best	Best	Best	Best	Best
34.	16UPIA0440	sharanya	sharanya	sharanya	sharanya	sharanya



*[Signature]*  
PRINCIPAL  
Vignans Institute of Management & Technology For Women  
Kondapur(V), Ghatkesar(M), Medchal-Malkajgiri(D)-501301  
Telangana State

35.	16UP1A0441	Kikitha	Kikitha	Kikitha	Kikitha	Kikitha
36.	16UP1A0442	Manjita	Manjita	Manjita	Manjita	Manjita
37.	16UP1A0443	Vani	Vani	Vani	Vani	Vani
38.	16UP1A0445	Saravani	Saravani	Saravani	Saravani	Saravani
39.	16UP1A0446	S.Manidapa	S.Manidapa	S.Manidapa	S.Manidapa	S.Manidapa
40.	16UP1A0447	k.f	k.f	k.f	k.f	k.f
41.	16UP1A0448	V.sushma	V.sushma	V.sushma	V.sushma	V.sushma

  
COORDINATOR

  
ECE,HOD

Head of the Department  
Electronics and Communication Engineering  
Tatyasaheb Kore Institute of Technology for Women  
Kondapur (V), Ghatsiesar (M), Medchal-Malkajgiri (Dt), H.No. Dist.No.01001



  
PRINCIPAL

Tatyasaheb Kore Institute of Management & Technology For Women  
Kondapur(V),Ghatsiesar(M),Medchal-Malkajgiri(DT)-501301  
Telangana State



DEPARTMENT OF ELECTRONICS AND COMMUNICATION ENGINEERING

ADD ON COURSE NAME: Latest Developments in Microwave Antenna Design and Its Applications

Academic Year: 2019-20

Date: 05-09-2019

B.Tech IV-I SEM

DAY WISE ATTENDANCE SHEET

SECTION: ECE-B

S.No	Roll number	05-09-19	06-09-19	07-09-19	09-09-19	11-09-19
1.	16UP1A0449	Laxmi Priya	Laxmi Priya	Laxmi Priya	Laxmi Priya	Laxmi Priya
2.	16UP1A0451	Swishal	Swishal	Swishal	Swishal	Swishal
3.	16UP1A0453	Rekha	Rekha	Rekha	Rekha	Rekha
4.	16UP1A0454	Sushita	Sushita	Sushita	Sushita	Sushita
5.	16UP1A0455	P	P	P	P	P
6.	16UP1A0457	Divya	Divya	Divya	Divya	Divya
7.	16UP1A0458	Dharani	Dharani	Dharani	Dharani	Dharani
8.	16UP1A0459	C.S. Sumanalatha	C.S. Sumanalatha	C.S. Sumanalatha	C.S. Sumanalatha	C.S. Sumanalatha
9.	16UP1A0460	Supriya	Supriya	Supriya	Supriya	Supriya
10.	16UP1A0461	Swishal	Swishal	Swishal	Swishal	Swishal
11.	16UP1A0462	Nikitha	Nikitha	Nikitha	Nikitha	Nikitha
12.	16UP1A0463	Ravali	Ravali	Ravali	Ravali	Ravali
13.	16UP1A0464	Saumya	Saumya	Saumya	Saumya	Saumya
14.	16UP1A0465	Shivani	Shivani	Shivani	Shivani	Shivani
15.	16UP1A0466	Kat	Kat	Kat	Kat	Kat
16.	16UP1A0467	Neelima	Neelima	Neelima	Neelima	Neelima
17.	16UP1A0468	Keerthana	Keerthana	Keerthana	Keerthana	Keerthana
18.	16UP1A0469	Anitha	Anitha	Anitha	Anitha	Anitha
19.	16UP1A0470	Harika	Harika	Harika	Harika	Harika
20.	16UP1A0471	Varshitha	Varshitha	Varshitha	Varshitha	Varshitha
21.	16UP1A0472	Supriya	Supriya	Supriya	Supriya	Supriya
22.	16UP1A0473	M.S. Swetha	M.S. Swetha	M.S. Swetha	M.S. Swetha	M.S. Swetha
23.	16UP1A0474	Dhara	Dhara	Dhara	Dhara	Dhara
24.	16UP1A0475	Meghana	Meghana	Meghana	Meghana	Meghana
25.	16UP1A0476	Vinayita	Vinayita	Vinayita	Vinayita	Vinayita
26.	16UP1A0477	Alitha	Alitha	Alitha	Alitha	Alitha
27.	16UP1A0478	Kumari	Kumari	Kumari	Kumari	Kumari
28.	16UP1A0479	Teju	Teju	Teju	Teju	Teju
29.	16UP1A0481	Swetha	Swetha	Swetha	Swetha	Swetha
30.	16UP1A0482	P. Tulasi	P. Tulasi	P. Tulasi	P. Tulasi	P. Tulasi
31.	16UP1A0483	Sath	Sath	Sath	Sath	Sath
32.	16UP1A0484	Madhuri	Madhuri	Madhuri	Madhuri	Madhuri
33.	16UP1A0485	Saumya	Saumya	Saumya	Saumya	Saumya
34.	16UP1A0486	Kinga	Kinga	Kinga	Kinga	Kinga
35.	16UP1A0487	Navya	Navya	Navya	Navya	Navya



PRINCIPAL

Vignans Institute of Management & Technology for Women  
Kondapur (V), Ghatkesar (M), Medchal - Malkajgiri (D) - 501 301  
Telangana - India

36.	16UPIA0488	Suvarna	Suvarna	Suvarna	Suvarna	Suvarna
37.	16UPIA0489	S. Vashpuri Chavali	S. Vashpuri Chavali	S. Vashpuri Chavali	S. Vashpuri Chavali	S. Vashpuri Chavali
38.	16UPIA0490	Vindya	Vindya	Vindya	Vindya	Vindya
39.	16UPIA0492	Pravalika	Pravalika	Pravalika	Pravalika	Pravalika
40.	16UPIA0493	Umarani	Umarani	Umarani	Umarani	Umarani
41.	16UPIA0494	Nikitha	Nikitha	Nikitha	Nikitha	Nikitha
42.	16UPIA0495	Nikitha	Nikitha	Nikitha	Nikitha	Nikitha

  
COORDINATOR

  
ECE, HOD

Head of the Department  
Electronics and Communication Engineering  
Vign's Institute of Management and Technology for Women  
Kondapur (V), Ghatkesar (M), R.R. Dist-501 301



  
PRINCIPAL

Vign's Institute of Management & Technology for Women  
Kondapur(V), Ghatkesar(M), Medchal-Malkajgiri(OT)-501301  
Telangana State



DEPARTMENT OF ELECTRONICS AND COMMUNICATION ENGINEERING

ADD ON COURSE NAME: Latest Developments in Microwave Antenna Design and Its Applications

Academic Year: 2019-20

Date: 13-09-2019

B.Tech IV-I SEM

DAY WISE ATTENDANCE SHEET

SECTION: ECE-A

S.No	Roll number	13-09-19	16-09-19	17-09-19	18-09-19	19-09-19
1.	16UP1A0401	Rishitha	Rishitha	Rishitha	Rishitha	Rishitha
2.	16UP1A0402	Deepthi	Deepthi	Deepthi	Deepthi	Deepthi
3.	16UP1A0403	A. Tejashwini	A. Tejashwini	A. Tejashwini	A. Tejashwini	A. Tejashwini
4.	16UP1A0404	Geetha	Geetha	Geetha	Geetha	Geetha
5.	16UP1A0405	Rulhika	Rulhika	Rulhika	Rulhika	Rulhika
6.	16UP1A0407	sharanya	sharanya	sharanya	sharanya	sharanya
7.	16UP1A0408	Alethya	Alethya	Alethya	Alethya	Alethya
8.	16UP1A0409	Meghana	Meghana	Meghana	Meghana	Meghana
9.	16UP1A0410	Shanthi Sri	Shanthi Sri	Shanthi Sri	Shanthi Sri	Shanthi Sri
10.	16UP1A0412	G. Raj	G. Raj	G. Raj	G. Raj	G. Raj
11.	16UP1A0413	Sailekha	Sailekha	Sailekha	Sailekha	Sailekha
12.	16UP1A0414	Suma	Suma	Suma	Suma	Suma
13.	16UP1A0415	S. Srividya	S. Srividya	S. Srividya	S. Srividya	S. Srividya
14.	16UP1A0416	Sangeetha	Sangeetha	Sangeetha	Sangeetha	Sangeetha
15.	16UP1A0417	V. Sriyaa	V. Sriyaa	V. Sriyaa	V. Sriyaa	V. Sriyaa
16.	16UP1A0418	Pooja	Pooja	Pooja	Pooja	Pooja
17.	16UP1A0419	Arunika	Arunika	Arunika	Arunika	Arunika
18.	16UP1A0422	Aksh	Aksh	Aksh	Aksh	Aksh
19.	16UP1A0423	Keerthi	Keerthi	Keerthi	Keerthi	Keerthi
20.	16UP1A0424	Manas	Manas	Manas	Manas	Manas
21.	16UP1A0425	Raj	Raj	Raj	Raj	Raj
22.	16UP1A0426	Saranya	Saranya	Saranya	Saranya	Saranya
23.	16UP1A0427	Sai	Sai	Sai	Sai	Sai
24.	16UP1A0428	Sravani	Sravani	Sravani	Sravani	Sravani
25.	16UP1A0430	Chandika	Chandika	Chandika	Chandika	Chandika
26.	16UP1A0431	Panavi	Panavi	Panavi	Panavi	Panavi
27.	16UP1A0432	Ry	Ry	Ry	Ry	Ry
28.	16UP1A0434	Sindhya	Sindhya	Sindhya	Sindhya	Sindhya
29.	16UP1A0435	Nisha	Nisha	Nisha	Nisha	Nisha
30.	16UP1A0436	Kanika	Kanika	Kanika	Kanika	Kanika
31.	16UP1A0437	Ravali	Ravali	Ravali	Ravali	Ravali
32.	16UP1A0438	P. Anurupa	P. Anurupa	P. Anurupa	P. Anurupa	P. Anurupa
33.	16UP1A0439	Prat	Prat	Prat	Prat	Prat
34.	16UP1A0440	Sharanya	Sharanya	Sharanya	Sharanya	Sharanya
35.	16UP1A0441	Likitha	Likitha	Likitha	Likitha	Likitha



Principal  
Vignani's Institute of Management & Technology For Women  
Kondapur(V), Ghatkesar(M), Medchal - Malkajgiri(D) - 501 301  
Telangana State

36.	16UPIA0442	Mounika	Mounika	Mounika	Mounika	Mounika
37.	16UPIA0443	Vaib	Vaib	Vaib	Vaib	Vaib
38.	16UPIA0445	Saravani	Saravani	Saravani	Saravani	Saravani
39.	16UPIA0446	S.Monideepa	S.Monideepa	S.Monideepa	S.Monideepa	S.Monideepa
40.	16UPIA0447	Kf	Kf	Kf	Kf	Kf
41.	16UPIA0448	V.Sushma	V.Sushma	V.Sushma	V.Sushma	V.Sushma

  
COORDINATOR

  
ECE,HOD

Head of the Department  
Electronics and Communication Engineering  
Vignan's Institute of Management and Technology For Women  
Kondapur (V), Ghatkesar (M), R.R. Dist-501 301



  
PRINCIPAL  
Vignan's Institute of Management & Technology For Women  
Kondapur(V), Ghatkesar(M), Medchal-Malkajgiri(Dist)-R.R. Dist-501301  
Telangana State



DEPARTMENT OF ELECTRONICS AND COMMUNICATION ENGINEERING

ADD ON COURSE NAME: Latest Developments in Microwave Antenna Design and Its Applications

Academic Year: 2019-20

Date: 13-09-2019

B.Tech IV-I SEM

DAY WISE ATTENDANCE SHEET

SECTION: ECE-B

S.No	Roll number	13-09-19	16-09-19	17-09-19	18-09-19	19-09-19
1.	16UPIA0449	Laxmi Priya	Laxmi Priya	Laxmi Priya	Laxmi Priya	Laxmi Priya
2.	16UPIA0451	Swikha	Swikha	Swikha	Swikha	Swikha
3.	16UPIA0453	Rakha	Rakha	Rakha	Rakha	Rakha
4.	16UPIA0454	Surbha	Surbha	Surbha	Surbha	Surbha
5.	16UPIA0455	P	P	P	P	P
6.	16UPIA0457	Divya	Divya	Divya	Divya	Divya
7.	16UPIA0458	Dharani	Dharani	Dharani	Dharani	Dharani
8.	16UPIA0459	C.S.sammalatha	C.S.sammalatha	C.S.sammalatha	C.S.sammalatha	C.S.sammalatha
9.	16UPIA0460	Supriya	Supriya	Supriya	Supriya	Supriya
10.	16UPIA0461	D.Srinidhi	D.Srinidhi	D.Srinidhi	D.Srinidhi	D.Srinidhi
11.	16UPIA0462	Nikitha	Nikitha	Nikitha	Nikitha	Nikitha
12.	16UPIA0463	Ravali	Ravali	Ravali	Ravali	Ravali
13.	16UPIA0464	Soumya	Soumya	Soumya	Soumya	Soumya
14.	16UPIA0465	Shivani	Shivani	Shivani	Shivani	Shivani
15.	16UPIA0466	K	K	K	K	K
16.	16UPIA0467	Neelima	Neelima	Neelima	Neelima	Neelima
17.	16UPIA0468	Kudhar	Kudhar	Kudhar	Kudhar	Kudhar
18.	16UPIA0469	Anitha	Anitha	Anitha	Anitha	Anitha
19.	16UPIA0470	Pratika	Pratika	Pratika	Pratika	Pratika
20.	16UPIA0471	Jasmin	Jasmin	Jasmin	Jasmin	Jasmin
21.	16UPIA0472	Supriya	Supriya	Supriya	Supriya	Supriya
22.	16UPIA0473	M.Sushila	M.Sushila	M.Sushila	M.Sushila	M.Sushila
23.	16UPIA0474	Shwari	Shwari	Shwari	Shwari	Shwari
24.	16UPIA0475	Meghana	Meghana	Meghana	Meghana	Meghana
25.	16UPIA0476	Vinayita	Vinayita	Vinayita	Vinayita	Vinayita
26.	16UPIA0477	Neha	Neha	Neha	Neha	Neha
27.	16UPIA0478	Kumari	Kumari	Kumari	Kumari	Kumari
28.	16UPIA0479	Teju	Teju	Teju	Teju	Teju
29.	16UPIA0481	Swetha	Swetha	Swetha	Swetha	Swetha
30.	16UPIA0482	Taf	Taf	Taf	Taf	Taf
31.	16UPIA0483	P.Tulasi	P.Tulasi	P.Tulasi	P.Tulasi	P.Tulasi
32.	16UPIA0484	Rath	Rath	Rath	Rath	Rath
33.	16UPIA0485	Soumya	Soumya	Soumya	Soumya	Soumya
34.	16UPIA0486	Kingari	Kingari	Kingari	Kingari	Kingari
35.	16UPIA0487	Navya	Navya	Navya	Navya	Navya



PRINCIPAL  
Vignan's Institute of Management & Technology For Women  
Kondapur(V), Ghatkesar(M), Medchal-Malkajgiri(D), Telangana State

36.	16UP1A0488	Surena	Surena	Surena	Surena	Surena
37.	16UP1A0489	S.Vaishnavi chavali	S.Vaishnavi chavali	S.Vaishnavi chavali	S.Vaishnavi chavali	S.Vaishnavi chavali
38.	16UP1A0490	Vindya	Vindya	Vindya	Vindya	Vindya
39.	16UP1A0492	Pravali	Pravali	Pravali	Pravali	Pravali
40.	16UP1A0493	Umapati	Umapati	Umapati	Umapati	Umapati
41.	16UP1A0494	Nikitha	Nikitha	Nikitha	Nikitha	Nikitha
42.	16UP1A0495	Nikitha	Nikitha	Nikitha	Nikitha	Nikitha

  
COORDINATOR

  
HOD

Head of the Department  
Electronics and Communication Engineering  
Vignans Institute of Management & Technology for Women  
Kondapur (V), Ghatkesar (M), Medchal-Malkajgiri (DI), Pin-501301  
Telangana State



  
PRINCIPAL  
Vignans Institute of Management & Technology for Women  
Kondapur(V), Ghatkesar(M), Medchal-Malkajgiri(DI)-501301  
Telangana State





DEPARTMENT OF ELECTRONICS AND COMMUNICATION ENGINEERING

ADD ON COURSE NAME: Latest Developments in Microwave Antenna Design and Its Applications

Academic Year: 2019-20

Date: 20-09-2019

B.Tech IV-I SEM

DAY WISE ATTENDANCE SHEET

SECTION: ECE-A

S.No	Roll number	20-09-19	23-09-19	24-09-19	25-09-19	26-09-19
1.	16UPIA0401	Rishu-tha	Rishu-tha	Rishu-tha	Rishu-tha	Rishu-tha
2.	16UPIA0402	Deepthi	Deepthi	Deepthi	Deepthi	Deepthi
3.	16UPIA0403	A. Tejaswini	A. Tejaswini	A. Tejaswini	A. Tejaswini	A. Tejaswini
4.	16UPIA0404	Sai	Sai	Sai	Sai	Sai
5.	16UPIA0405	Pallavi	Pallavi	Pallavi	Pallavi	Pallavi
6.	16UPIA0407	Sharanya	Ab	Sharanya	Sharanya	Sharanya
7.	16UPIA0408	Alekhya	Alekhya	Alekhya	Alekhya	Alekhya
8.	16UPIA0409	Meghana	Meghana	Meghana	Meghana	Meghana
9.	16UPIA0410	Shanitha	Shanitha	Shanitha	Shanitha	Shanitha
10.	16UPIA0412	G. Raj	G. Raj	G. Raj	G. Raj	G. Raj
11.	16UPIA0413	Sulekha	Sulekha	Sulekha	Sulekha	Sulekha
12.	16UPIA0414	Cuma	Cuma	Cuma	Cuma	Cuma
13.	16UPIA0415	J. Srividya	J. Srividya	J. Srividya	J. Srividya	J. Srividya
14.	16UPIA0416	Sangeetha	Sangeetha	Sangeetha	Sangeetha	Sangeetha
15.	16UPIA0417	V. Sriyaji	V. Sriyaji	V. Sriyaji	V. Sriyaji	V. Sriyaji
16.	16UPIA0418	Pooja	Pooja	Pooja	Pooja	Pooja
17.	16UPIA0419	Akanksha	Akanksha	Akanksha	Akanksha	Akanksha
18.	16UPIA0422	Aksh	Aksh	Ab	Aksh	Aksh
19.	16UPIA0423	Keerthi	Keerthi	Keerthi	Keerthi	Keerthi
20.	16UPIA0424	Manas	Manas	Manas	Manas	Manas
21.	16UPIA0425	Raj	Raj	Raj	Raj	Raj
22.	16UPIA0426	Saranya	Saranya	Saranya	Saranya	Saranya
23.	16UPIA0427	Sai	Sai	Sai	Sai	Sai
24.	16UPIA0428	Srayani	Srayani	Srayani	Srayani	Srayani
25.	16UPIA0430	Chandrika	Chandrika	Chandrika	Chandrika	Chandrika
26.	16UPIA0431	Bhanu	Bhanu	Bhanu	Bhanu	Bhanu
27.	16UPIA0432	Ry	Ry	Ry	Ry	Ry
28.	16UPIA0434	Srinu	Srinu	Srinu	Srinu	Srinu
29.	16UPIA0435	Nithya	Nithya	Nithya	Nithya	Nithya
30.	16UPIA0436	Kavita	Kavita	Kavita	Kavita	Kavita
31.	16UPIA0437	Ravali	Ravali	Ravali	Ravali	Ravali
32.	16UPIA0438	P. Narmada	P. Narmada	P. Narmada	P. Narmada	P. Narmada
33.	16UPIA0439	Prat	Prat	Prat	Prat	Prat
34.	16UPIA0440	Sharanya	Sharanya	Sharanya	Sharanya	Sharanya
35.	16UPIA0441	Lakshya	Lakshya	Lakshya	Lakshya	Lakshya



*[Signature]*  
PRINCIPAL

Vignans Institute of Management & Technology For Women  
Kondapur(V), Ghatkesar(M), Medchal-Malkajgiri(D)-501301  
Telangana State

36.	16UP1A0442	Manika	Manika	Manika	Manika	Manika
37.	16UP1A0443	Yash	Yash	Yash	Yash	Yash
38.	16UP1A0445	Saavani	Saavani	Saavani	Saavani	Saavani
39.	16UP1A0446	S.Manidepu	S.Manidepu	S.Manidepu	S.Manidepu	S.Manidepu
40.	16UP1A0447	KJ	KJ	KJ	KJ	KJ
41.	16UP1A0448	V.Sushma	V.Sushma	V.Sushma	V.Sushma	V.Sushma

  
COORDINATOR

  
HOD

Head of the Department  
Electronics and Communication Engineering  
Man's Institute of Management and Technology for Women  
Kondapur (V), Ghatkesar (M), R.R. Dist-501 301





PRINCIPAL  
Man's Institute of Management & Technology for Women  
Kondapur (V), Ghatkesar (M), Medchal-Malkajgiri (Dt), R.R. Dist-501 301  
Telangana State



DEPARTMENT OF ELECTRONICS AND COMMUNICATION ENGINEERING

ADD ON COURSE NAME: Latest Developments in Microwave Antenna Design and Its Applications

Academic Year: 2019-20

Date: 20-09-2019

B.Tech IV-I SEM

DAY WISE ATTENDANCE SHEET

SECTION: ECE-B

S.No	Roll number	20-09-19	23-09-19	24-09-19	25-09-19	26-09-19
1.	16UP1A0449	darini Priya	darini Priya	darini Priya	darini Priya	darini Priya
2.	16UP1A0451	Sirisha	Sirisha	Sirisha	Sirisha	Sirisha
3.	16UP1A0453	Rekha	Rekha	Rekha	Rekha	Rekha
4.	16UP1A0454	Sushita	Sushita	Sushita	Sushita	Sushita
5.	16UP1A0455	(R)	(R)	(R)	(R)	(R)
6.	16UP1A0457	Divya	Divya	Divya	Divya	Divya
7.	16UP1A0458	Dharani	Dharani	Dharani	Dharani	Dharani
8.	16UP1A0459	C.Saravathula	C.Saravathula	C.Saravathula	C.Saravathula	C.Saravathula
9.	16UP1A0460	Supriya	Supriya	Supriya	Supriya	Supriya
10.	16UP1A0461	(D) Sri Parvathi	(D) Sri Parvathi	(D) Sri Parvathi	AB	(D) Sri Parvathi
11.	16UP1A0462	Nikitha	Nikitha	Nikitha	Nikitha	Nikitha
12.	16UP1A0463	Ravali	Ravali	Ravali	Ravali	Ravali
13.	16UP1A0464	Seemya	Seemya	Seemya	Seemya	Seemya
14.	16UP1A0465	Shivani	Shivani	Shivani	Shivani	Shivani
15.	16UP1A0466	KJ	KJ	KJ	KJ	KJ
16.	16UP1A0467	Neelima	Neelima	Neelima	Neelima	Neelima
17.	16UP1A0468	Kaushal	Kaushal	Kaushal	Kaushal	Kaushal
18.	16UP1A0469	Anitha	Anitha	Anitha	Anitha	Anitha
19.	16UP1A0470	Harika	Harika	Harika	Harika	Harika
20.	16UP1A0471	Varsha	Varsha	Varsha	Varsha	Varsha
21.	16UP1A0472	Supriya	Supriya	Supriya	Supriya	Supriya
22.	16UP1A0473	Misubhla	Misubhla	Misubhla	Misubhla	Misubhla
23.	16UP1A0474	Charani	Charani	Charani	Charani	Charani
24.	16UP1A0475	Meghana	Meghana	Meghana	Meghana	Meghana
25.	16UP1A0476	Vinayita	Vinayita	Vinayita	Vinayita	Vinayita
26.	16UP1A0477	Neha	Neha	Neha	Neha	Neha
27.	16UP1A0478	Kumari	Kumari	Kumari	Kumari	Kumari
28.	16UP1A0479	Teju	Teju	Teju	Teju	Teju
29.	16UP1A0481	Smita	Smita	Smita	Smita	Smita
30.	16UP1A0482	Madhuri	Madhuri	Madhuri	Madhuri	Madhuri
31.	16UP1A0483	P.Tulasi	P.Tulasi	P.Tulasi	P.Tulasi	P.Tulasi
32.	16UP1A0484	Sath	Sath	Sath	Sath	Sath
33.	16UP1A0485	Sowmya	Sowmya	Sowmya	Sowmya	Sowmya
34.	16UP1A0486	Singari	Singari	Singari	Singari	Singari
35.	16UP1A0487	Navya	Navya	Navya	Navya	Navya



PRINCIPAL

Vignans Institute of Management & Technology for Women  
Kondapur (V), Ghatkesar (M), Medchal - Malkajgiri (D) - 501 301 Phone: +91 96529 1000/3

36.	16UP1A0488	Suvarna	Suvarna	Suvarna	Suvarna	Suvarna
37.	16UP1A0489	S. Vishwani Chavali	S. Vishwani Chavali	S. Vishwani Chavali	S. Vishwani Chavali	S. Vishwani Chavali
38.	16UP1A0490	Vindya	Vindya	Vindya	Vindya	Vindya
39.	16UP1A0492	Pravalika	Pravalika	Pravalika	Pravalika	Ab
40.	16UP1A0493	Ommani	Ommani	Ommani	Ommani	Ommani
41.	16UP1A0494	Nikitha	Nikitha	Nikitha	Nikitha	Nikitha
42.	16UP1A0495	Nikitha	Nikitha	Nikitha	Nikitha	Nikitha

  
COORDINATOR

  
HOD

Head of the Department  
Electronics and Communication Engineering  
Vignans Institute of Management and Technology For Women  
Kondapur (V), Ghatkesar (M), R.R. Dist-501 301



  
PRINCIPAL

Vignans Institute of Management & Technology For Women  
Kondapur(V), Ghatkesar(M), Medchal-Malkajgiri(D)-501301  
Telangana State



DEPARTMENT OF ELECTRONICS AND COMMUNICATION ENGINEERING

ADD ON COURSE NAME: Latest Developments in Microwave Antenna Design and Its Applications

Academic Year: 2019-20

Date: 27-09-2019

B.Tech IV-I SEM

DAY WISE ATTENDANCE SHEET

SECTION: ECE-A

S.No	Roll number	27-09-19	01-10-19	02-10-19	03-10-19	04-10-19
1.	16UPIA0401	Kishitha	Kishitha	Kishitha	Kishitha	Kishitha
2.	16UPIA0402	Deepthi	Deepthi	Deepthi	Deepthi	Deepthi
3.	16UPIA0403	A. Tejashwini	A. Tejashwini	A. Tejashwini	A. Tejashwini	A. Tejashwini
4.	16UPIA0404	Sai	Sai	Sai	Sai	Sai
5.	16UPIA0405	Rulbika	Rulbika	Rulbika	Rulbika	Rulbika
6.	16UPIA0407	Sharanya	Sharanya	Sharanya	Sharanya	Sharanya
7.	16UPIA0408	Alekhy	Alekhy	Alekhy	Alekhy	Alekhy
8.	16UPIA0409	Meghara	Meghara	Meghara	Meghara	Meghara
9.	16UPIA0410	Shanthi Sri	Shanthi Sri	Shanthi Sri	Shanthi Sri	Shanthi Sri
10.	16UPIA0412	G. Raj	G. Raj	G. Raj	G. Raj	G. Raj
11.	16UPIA0413	Sulekha	Sulekha	Sulekha	Sulekha	Sulekha
12.	16UPIA0414	Suma	Suma	Suma	Suma	Suma
13.	16UPIA0415	J. Srividya	J. Srividya	J. Srividya	J. Srividya	J. Srividya
14.	16UPIA0416	Sangeetha	Sangeetha	Sangeetha	Sangeetha	Sangeetha
15.	16UPIA0417	V. Sriyog	V. Sriyog	V. Sriyog	V. Sriyog	V. Sriyog
16.	16UPIA0418	Pooja	Pooja	Pooja	Pooja	Pooja
17.	16UPIA0419	Akanksha	Akanksha	Akanksha	Akanksha	Akanksha
18.	16UPIA0422	AKS	AKS	AKS	AKS	AKS
19.	16UPIA0423	Keerthi	Keerthi	Keerthi	Keerthi	Keerthi
20.	16UPIA0424	Manas	Manas	Manas	Manas	Manas
21.	16UPIA0425	Raj	Raj	Raj	Raj	Raj
22.	16UPIA0426	Saranya	Saranya	Saranya	Saranya	Saranya
23.	16UPIA0427	Sai	Sai	Sai	Sai	Sai
24.	16UPIA0428	Swarni	Swarni	Swarni	Swarni	Swarni
25.	16UPIA0430	Chandrika	Chandrika	Chandrika	Chandrika	Chandrika
26.	16UPIA0431	Pranavi	Pranavi	Pranavi	Pranavi	Pranavi
27.	16UPIA0432	Ry	Ry	Ry	Ry	Ry
28.	16UPIA0434	Sindhya	Sindhya	Sindhya	Sindhya	Sindhya
29.	16UPIA0435	Nishat	Nishat	Nishat	Nishat	Nishat
30.	16UPIA0436	Kanika	Kanika	Kanika	Kanika	Kanika
31.	16UPIA0437	Ravali	Ravali	Ravali	Ravali	Ravali
32.	16UPIA0438	Prasanna	Prasanna	Prasanna	Prasanna	Prasanna
33.	16UPIA0439	Host	Host	Host	Host	Host
34.	16UPIA0440	Sharanya	Sharanya	Sharanya	Sharanya	Sharanya



Vignans Institute of Management & Technology For Women  
Kondapur(V), Ghatkesar(M), Medchal - Malkajgiri(D) - 501301  
Telangana State

35.	16UPIA0441	Kikilthg	Kikilthg	Kikilthg	Kikilthg	Kikilthg
36.	16UPIA0442	Moxnka	Moxnka	Moxnka	Moxnka	Moxnka
37.	16UPIA0443	Vust	Vust	Vust	Vust	Vust
38.	16UPIA0445	Sarvani	Sarvani	Sarvani	Sarvani	Sarvani
39.	16UPIA0446	S.Manideopa	S.Manideopa	S.Manideopa	S.Manideopa	S.Manideopa
40.	16UPIA0447	Kf	Kf	Kf	Kf	Kf
41.	16UPIA0448	V.sushma	V.sushma	V.sushma	V.sushma	V.sushma

  
COORDINATOR

  
HOD

Head of the Department  
Electronic and Communication Engineering  
Vignans Institute of Management and Technology for Women  
Kondapur (V), Ghatkesar (M), R.R. Dist-501 301



  
PRINCIPAL  
Vignans Institute of Management & Technology for Women  
Kondapur(V), Ghatkesar(M), Medchal-Nalgonda(Dist)  
Telangana State



DEPARTMENT OF ELECTRONICS AND COMMUNICATION ENGINEERING

ADD ON COURSE NAME: Latest Developments in Microwave Antenna Design and Its Applications

Academic Year: 2019-20

Date: 27-09-2019

B.Tech IV-I SEM

DAY WISE ATTENDANCE SHEET

SECTION: ECE-B

S.No	Roll number	27-09-19	01-10-19	02-10-19	03-10-19	04-10-19
1.	16UPIA0449	darani Priya	darani Priya	darani Priya	darani Priya	darani Priya
2.	16UPIA0451	Sirisha	Sirisha	Sirisha	Sirisha	Sirisha
3.	16UPIA0453	Rakha	Rakha	Rakha	Rakha	Rakha
4.	16UPIA0454	suktha	suktha	suktha	suktha	suktha
5.	16UPIA0455	P	P	P	P	P
6.	16UPIA0457	Durga	Durga	Durga	Durga	Durga
7.	16UPIA0458	Dharani	Dharani	Dharani	Dharani	Dharani
8.	16UPIA0459	C.Sourmalatha	C.Sourmalatha	C.Sourmalatha	C.Sourmalatha	C.Sourmalatha
9.	16UPIA0460	Supriya	Supriya	Supriya	Supriya	Supriya
10.	16UPIA0461	D.Sridurga	D.Sridurga	D.Sridurga	D.Sridurga	D.Sridurga
11.	16UPIA0462	Nikitha	Nikitha	Nikitha	Nikitha	Nikitha
12.	16UPIA0463	Ravali	Ravali	Ravali	Ravali	Ravali
13.	16UPIA0464	Soumya	Soumya	Soumya	Soumya	Soumya
14.	16UPIA0465	Shivani	Shivani	Shivani	Shivani	Shivani
15.	16UPIA0466	Kriti	Kriti	Kriti	Kriti	Kriti
16.	16UPIA0467	Neelima	Neelima	Neelima	Neelima	Neelima
17.	16UPIA0468	Karthika	Karthika	Karthika	Karthika	Karthika
18.	16UPIA0469	Anitha	Anitha	Anitha	Anitha	Anitha
19.	16UPIA0470	Haritha	Haritha	Haritha	Haritha	Haritha
20.	16UPIA0471	Jarabhi	Jarabhi	Jarabhi	Jarabhi	Jarabhi
21.	16UPIA0472	Supriya	Supriya	Supriya	Supriya	Supriya
22.	16UPIA0473	H.Sudha	H.Sudha	H.Sudha	H.Sudha	H.Sudha
23.	16UPIA0474	Charani	Charani	Charani	Charani	Charani
24.	16UPIA0475	Meghana	Meghana	Meghana	Meghana	Meghana
25.	16UPIA0476	Vinayita	Vinayita	Vinayita	Vinayita	Vinayita
26.	16UPIA0477	Neha	Neha	Neha	Neha	Neha
27.	16UPIA0478	Kumari	Kumari	Kumari	Kumari	Kumari
28.	16UPIA0479	Teju	Teju	Teju	Teju	Teju
29.	16UPIA0481	Swetha	Swetha	Swetha	Swetha	Swetha
30.	16UPIA0482	P.Tulasi	P.Tulasi	P.Tulasi	P.Tulasi	P.Tulasi
31.	16UPIA0483	Swetha	Swetha	Swetha	Swetha	Swetha
32.	16UPIA0484	Madhul	Madhul	Madhul	Madhul	Madhul
33.	16UPIA0485	Soumya	Soumya	Soumya	Soumya	Soumya
34.	16UPIA0486	Singa	Singa	Singa	Singa	Singa



PRINCIPAL  
Vignana's Institute of Management & Technology For Women  
Kondapur(V), Ghatkesar(M), Medchal-Malkajgiri(D)-501301  
Telangana State

35.	16UP1A0487	Navya	Navya	Navya	Navya	Navya
36.	16UP1A0488	Susmita	Susmita	Susmita	Susmita	Susmita
37.	16UP1A0489	S. Vaishnavi Chavali	S. Vaishnavi Chavali	S. Vaishnavi Chavali	S. Vaishnavi Chavali	S. Vaishnavi Chavali
38.	16UP1A0490	Vindya	Vindya	Vindya	Vindya	Vindya
39.	16UP1A0492	Pravali	Pravali	Pravali	Pravali	Pravali
40.	16UP1A0493	Amritha	Amritha	Amritha	Amritha	Amritha
41.	16UP1A0494	N. Nikitha	N. Nikitha	N. Nikitha	N. Nikitha	N. Nikitha
42.	16UP1A0495	Nikitha	Nikitha	Nikitha	Nikitha	Nikitha

  
COORDINATOR

  
HOD

Head of the Department  
Electronics and Communication Engineering  
Vignans Institute of Management and Technology For Women  
Kondapur (V), Ghatkesar (M), R.R. Dist-501301



  
PRINCIPAL  
Vignans Institute of Management & Technology For Women  
Kondapur(V), Ghatkesar(M), Medchal-Malkajgiri(Dt-501301)  
Telangana State





DEPARTMENT OF ELECTRONICS AND COMMUNICATION ENGINEERING

ADD ON COURSE NAME: Latest Developments in Microwave Antenna Design and Its Applications

Academic Year: 2019-20

Date: 01-11-2019

B.Tech IV-I SEM

DAY WISE ATTENDANCE SHEET

SECTION: ECE-A

S.No	Roll number	01-11-19	04-11-19	05-11-19	06-11-19	12-11-19
1.	16UPIA0401	Rishitha	Rishitha	Rishitha	Rishitha	Rishitha
2.	16UPIA0402	Deepthi	Deepthi	Deepthi	Deepthi	Deepthi
3.	16UPIA0403	A. Tejashwini	A. Tejashwini	A. Tejashwini	A. Tejashwini	A. Tejashwini
4.	16UPIA0404	Gay	Gay	Gay	Gay	Gay
5.	16UPIA0405	Ruthika	Ruthika	Ruthika	Ruthika	Ruthika
6.	16UPIA0407	Charanya	Charanya	Charanya	Charanya	Charanya
7.	16UPIA0408	Alekhyas	Alekhyas	Alekhyas	Alekhyas	Alekhyas
8.	16UPIA0409	Meghana	Meghana	Meghana	Meghana	Meghana
9.	16UPIA0410	Shanithi Sri	Shanithi Sri	Shanithi Sri	Shanithi Sri	Shanithi Sri
10.	16UPIA0412	G. Raj	G. Raj	G. Raj	G. Raj	G. Raj
11.	16UPIA0413	Sailekha	Sailekha	Sailekha	Sailekha	Sailekha
12.	16UPIA0414	Suma	Suma	Suma	Suma	Suma
13.	16UPIA0415	J. Sruvidya	J. Sruvidya	J. Sruvidya	J. Sruvidya	J. Sruvidya
14.	16UPIA0416	Sangeetha	Sangeetha	Sangeetha	Sangeetha	Sangeetha
15.	16UPIA0417	V. Sriyaf	V. Sriyaf	V. Sriyaf	V. Sriyaf	V. Sriyaf
16.	16UPIA0418	Pooja	Pooja	Pooja	Pooja	Pooja
17.	16UPIA0419	Akanksha	Akanksha	Akanksha	Akanksha	Akanksha
18.	16UPIA0422	AKS	AKS	AKS	AKS	AKS
19.	16UPIA0423	Keerthi	Keerthi	Ab	Keerthi	Keerthi
20.	16UPIA0424	Mamas	Mamas	Mamas	Mamas	Mamas
21.	16UPIA0425	Raj	Raj	Raj	Raj	Raj
22.	16UPIA0426	Saranya	Saranya	Saranya	Saranya	Saranya
23.	16UPIA0427	Sai	Sai	Sai	Sai	Sai
24.	16UPIA0428	Sravani	Sravani	Sravani	Sravani	Sravani
25.	16UPIA0430	Chandrika	Chandrika	Chandrika	Chandrika	Chandrika
26.	16UPIA0431	Purnavi	Purnavi	Purnavi	Purnavi	Purnavi
27.	16UPIA0432	Raj	Raj	Raj	Raj	Raj
28.	16UPIA0434	Sindhya	Sindhya	Sindhya	Sindhya	Sindhya
29.	16UPIA0435	Nishat	Nishat	Nishat	Nishat	Nishat
30.	16UPIA0436	Kauke	Kauke	Kauke	Kauke	Kauke
31.	16UPIA0437	Ravali	Ravali	Ravali	Ravali	Ravali
32.	16UPIA0438	P. Narmada	P. Narmada	P. Narmada	P. Narmada	P. Narmada
33.	16UPIA0439	Gay	Gay	Gay	Gay	Gay
34.	16UPIA0440	Sharanya	Sharanya	Sharanya	Sharanya	Sharanya



24/11  
PRINCIPAL

Vignan's Institute of Management & Technology For Women  
Kondapur (V), Ghatkesar (M), Medchal - Malkajgiri (D) - 501 301  
Telangana State

35.	16UPIA0441	Kishita	Kishita	Kishita	Kishita	Kishita
36.	16UPIA0442	Mamika	Mamika	Mamika	Mamika	Mamika
37.	16UPIA0443	Vani	Vani	Vani	Vani	Vani
38.	16UPIA0445	Sarvani	Sarvani	Sarvani	Sarvani	Sarvani
39.	16UPIA0446	S-Manideepa	S-Manideepa	S-Manideepa	S-Manideepa	S-Manideepa
40.	16UPIA0447	K.J.	K.J.	K.J.	K.J.	K.J.
41.	16UPIA0448	V.sushma	V.sushma	V.sushma	V.sushma	V.sushma

  
COORDINATOR

  
HOD

Head of the Department  
Electronics and Communication Engineering  
Vignee's Institute of Management and Technology for Women  
Kondapur (V), Ghatkesar (M), Medchal-Malkajgiri (Dt)  
T.S.



  
PRINCIPAL

Vignee's Institute of Management & Technology For Women  
Kondapur(V),Ghatkesar(M),Medchal-Malkajgiri(Dt)  
Telangana State



DEPARTMENT OF ELECTRONICS AND COMMUNICATION ENGINEERING

ADD ON COURSE NAME: Latest Developments in Microwave Antenna Design and Its Applications

Academic Year: 2019-20

Date: 01-11-2019

B.Tech IV-I SEM

DAY WISE ATTENDANCE SHEET

SECTION: ECE-B

S.No	Roll number	01-11-19	04-11-19	05-11-19	06-11-19	12-11-19
1.	16UPIA0449	Darshi Priya	Darshi Priya	Darshi Priya	Darshi Priya	Darshi Priya
2.	16UPIA0451	Sirisha	Sirisha	Sirisha	Sirisha	Sirisha
3.	16UPIA0453	Rekha	Rekha	Rekha	Rekha	Rekha
4.	16UPIA0454	Suktha	Suktha	Suktha	Suktha	Suktha
5.	16UPIA0455	P	P	P	P	P
6.	16UPIA0457	Divya	Divya	Divya	Divya	Divya
7.	16UPIA0458	Dharani	Dharani	Dharani	Dharani	Dharani
8.	16UPIA0459	C.Swarma	C.Swarma	C.Swarma	C.Swarma	C.Swarma
9.	16UPIA0460	Supriya	Supriya	Supriya	Supriya	Supriya
10.	16UPIA0461	D.SriPragna	D.SriPragna	D.SriPragna	D.SriPragna	D.SriPragna
11.	16UPIA0462	Nidhiha	Nidhiha	Ab	Nidhiha	Nidhiha
12.	16UPIA0463	Ravali	Ravali	Ravali	Ravali	Ravali
13.	16UPIA0464	Soumya	Soumya	Soumya	Soumya	Soumya
14.	16UPIA0465	Shivani	Shivani	Shivani	Shivani	Shivani
15.	16UPIA0466	Kat	Kat	Kat	Kat	Kat
16.	16UPIA0467	Neelima	Neelima	Neelima	Neelima	Neelima
17.	16UPIA0468	Kecithana	Kecithana	Kecithana	Kecithana	Kecithana
18.	16UPIA0469	Anitha	Anitha	Anitha	Anitha	Anitha
19.	16UPIA0470	Halika	Halika	Halika	Halika	Halika
20.	16UPIA0471	Jamalya	Jamalya	Jamalya	Jamalya	Jamalya
21.	16UPIA0472	Supriya	Supriya	Supriya	Supriya	Supriya
22.	16UPIA0473	M.Sudetha	M.Sudetha	M.Sudetha	M.Sudetha	M.Sudetha
23.	16UPIA0474	Dharani	Dharani	Dharani	Dharani	Dharani
24.	16UPIA0475	Meghana	Meghana	Meghana	Meghana	Meghana
25.	16UPIA0476	Vinayita	Vinayita	Vinayita	Vinayita	Vinayita
26.	16UPIA0477	Neha	Neha	Neha	Neha	Neha
27.	16UPIA0478	Kumari	Kumari	Kumari	Kumari	Kumari
28.	16UPIA0479	Taru	Taru	Taru	Taru	Taru
29.	16UPIA0481	Suretha	Suretha	Suretha	Suretha	Suretha
30.	16UPIA0482	Madhuri	Madhuri	Madhuri	Madhuri	Madhuri
31.	16UPIA0483	P.Tulasi	P.Tulasi	P.Tulasi	P.Tulasi	P.Tulasi
32.	16UPIA0484	Madhuri	Madhuri	Madhuri	Madhuri	Madhuri
33.	16UPIA0485	Soumya	Soumya	Soumya	Soumya	Soumya
34.	16UPIA0486	Navya	Navya	Navya	Navya	Navya



*[Signature]*  
PRINCIPAL

Vignans Institute of Management & Technology For Women  
Kondapur(V), Ghatkesar(M), Medchal-Malkajgiri(D)  
Telangana-501301

35.	16UPIA0487	Navya	Navya	Navya	Navya	Navya
36.	16UPIA0488	Shikha	Shikha	Shikha	Shikha	Shikha
37.	16UPIA0489	S. Vaidhyanath Chavali	S. Vaidhyanath Chavali	S. Vaidhyanath Chavali	S. Vaidhyanath Chavali	S. Vaidhyanath Chavali
38.	16UPIA0490	Vindya	Vindya	Vindya	Vindya	Vindya
39.	16UPIA0492	Pravalika	Pravalika	Pravalika	Pravalika	Pravalika
40.	16UPIA0493	Chasani	Chasani	Chasani	Chasani	Chasani
41.	16UPIA0494	Nikitha	Nikitha	Nb	Nikitha	Nikitha
42.	16UPIA0495	Nikitha	Nikitha	Nikitha	Nikitha	Nikitha

  
COORDINATOR

  
HOD

Head of the Department  
Electronics and Communication Engineering  
Vignans Institute of Management and Technology For Women  
Kondapur (V), Ghatkesar (M), R.R. Dist-501 301



  
PRINCIPAL

Vignans Institute of Management & Technology For Women  
Kondapur(V), Ghatkesar(M), Medchal-Malkajgiri(DN), Pin-501 301  
Telangana State



**DEPARTMENT OF ELECTRONICS AND COMMUNICATION ENGINEERING**

Date: 14-11-2019

**PROGRAM REPORT**

**Name of the Add on Course:** Latest developments in microwave antenna design and its Applications.

**Day/Duration:** 35 Hours.

**Time:** 4:00PM to 5:00PM.

**Resource Person:** Mr. A.Venkat Reddy, Sr. Senior Engineer, Elegant Embedded Solutions.

**Name of the Coordinator:** Mr. J. Sunil Kumar, Assistant Professor, VMTW.

**Number of the Participants:** 83.

**Course objectives:**

1. Microwave devices and circuits.
2. Satellite communications.

**Topics covered:** The following topics covered in this program

- Smart & MIMO antenna design
- Antenna parameters and design considerations
- MM Wave/THz Integrated Circuits.
- Have an in-depth knowledge on Microwave devices and circuits & Satellite communications.
- Have an in-depth knowledge on Micro strip & CPW antennas, Implantable Antennas.

**Course Outcomes:**

COs	At the end of the course, students will have the ability to:	POs Mapped	Strength of mapping
CO1	Able to Working with Smart & MIMO antenna design.	PO3,PO4	3
CO2	Able to understand the Micro wave device VTC	PO2,PO3	4
CO3	Able to Working with Wearable UWB Antennas for body area network	PO2,PO4	2
CO4	Able to understand the characteristics of Micro strip & CPW antennas.	PO2,PO3	2

**Assessment Procedure:** The assessment of the Add on course is conducted in Multiple Choice Questions through offline Mode.



*(Signature)*

**ECE, HOD**

Head of the Department  
Electronics and Communication Engineering  
Vignans Institute of Management & Technology  
Kondapur (V), Ghatkesar (M), Medchal-Malkajgiri (D)-501301  
Telangana State

*(Signature)*

**PRINCIPAL**

Vignans Institute of Management & Technology For Women  
Kondapur(V),Ghatkesar(M),Medchal-Malkajgiri(D)-501301  
Telangana State



# VIGNAN'S INSTITUTE OF MANAGEMENT AND TECHNOLOGY FOR WOMEN

(Sponsored by Lavu Educational Society)

Approved by AICTE, New Delhi & Affiliated to JNTUH, Hyderabad.

Kondapur (V), Ghatkesar (M), Medchal - Malkajgiri (D) - 501 301

Accredited By



## Course Completion Certificate



ELEGANT EMBEDDED SOLUTIONS PVT. LTD.

*This is to certify that*

**GAJALA SHANTHI SRI**

*has successfully completed the Add-on course on*

**"LATEST DEVELOPMENT IN MICROWAVE ANTENNA DESIGN AND ITS APPLICATIONS"** held from 26-08-2019 to 12-11-2019, Organized by the Department of Electronics and Communication Engineering, in collaboration with **Elegant Embedded Solutions Pvt. Ltd.**

Co-ordinator



*[Signature]*  
HoD, ECE

Head of the Department  
Electronics and Communication Engineering  
Vignan's Institute of Management and Technology for Women

*[Signature]*  
PRINCIPAL

Vignan's Institute of Management & Technology For Women  
Kondapur(V), Ghatkesar(M), Medchal-Malkajgiri(D) - 501 301  
Telangana State

*[Signature]*  
Principal, VMTW  
PRINCIPAL

Vignan's Institute of Management & Technology For Women  
Kondapur(V), Ghatkesar(M), Medchal-Malkajgiri(D) - 501 301  
Telangana State



# VIGNAN'S INSTITUTE OF MANAGEMENT AND TECHNOLOGY FOR WOMEN

Sponsored by Lavu Educational Society, Approved by AICTE, New Delhi & Affiliated to JNTUH, Hyderabad.  
Kondapur (V), Ghatkesar (M), Medchal - Malkajgiri (D) - 501 301 TS INDIA  
Phone: +08815 200006/07/08 Email: info@vmtw.in

## DEPARTMENT OF ELECTRONICS AND COMMUNICATION ENGINEERING

VMTW/ECE/AOC/CIR/2018-19/I/01

18-07-2018.

### CIRCULAR

This is to inform all the II B. Tech ECE students that there will be an Add on course on "MATLAB for beginners" in association with Elegant Embedded Solutions PVT LTD., Hyderabad, from 20-07-2018 to 30-08-2018 All students are invited to take part in this course. The participating students will be honored with certificates of participation. During the course you will be encouraged to interact with the speaker and the other participants through the case study discussions. Hence those who are interested can sign in registration form.

HOD.

Copy to

- The Principal, for kind information
- IQAC
- Notice board
- II.B.Tech students
- Dept. file

Head of the Department  
Electronics and Communication Engineering  
Vignani's Institute of Management & Technology for Women  
Kondapur (V), Ghatkesar (M), Medchal - Malkajgiri (D) - 501 301



Principal  
Vignani's Institute of Management & Technology for Women  
Kondapur(V), Ghatkesar(M), Medchal-Malkajgiri(D)-501301  
Telangana State

### About the Course:

The course provides a gentle introduction to the MATLAB computing environment and is intended for beginning users and those looking for a review. It is designed to give students a basic understanding of MATLAB, including popular toolboxes. The course consists of interactive lectures and sample MATLAB problems that generally they face. The hands-on session helped students with the syntaxes and functions for use in programming. The tool helps at various stages in studying subjects related to processing and analysis during regular subjects throughout courses. No prior programming experience or knowledge of MATLAB is assumed. Concepts covered include basic use, graphical representations and tips for designing and implementing MATLAB code.

### Course Objectives:

- Understanding the MATLAB environment.
- Being able to do simple calculations using MATLAB.
- Being able to carry out simple numerical computations, analyses and graphics using MATLAB.

### Expected Outcomes:

At the end of Workshop, participants will be able to

- Understand the main features of the MATLAB

development environment.

- Use the MATLAB GUI effectively.
- Basic syntax, Looping, 2D & 3D Plotting.
- Design simple algorithms to solve problems.
- Write simple programs in MATLAB to solve scientific and mathematical problems.
  - a) Solution of simultaneous linear equation.
  - b) Solution of simultaneous non-linear equation.
  - c) Regression, splines and polynomial interpolation.
  - d) Solution of ordinary differential equation.
  - e) Numerical Integration.
  - f) Basics optimization procedure.



Resource Person:

**Mr. K. Jagadeeshwar Reddy,**  
Technical Manager,  
Elegant embedded solutions Pvt. Ltd,  
Hyderabad.

Co-ordinator:

**Mr. E. Nagaraju,**  
Assistant Professor,  
Department of ECE,  
Contact No: +91 83747 17668

**Last Date For Registration: 12<sup>th</sup> July, 2018**

# VIGNAN'S INSTITUTE OF MANAGEMENT AND TECHNOLOGY FOR WOMEN

(Sponsored by Lavu Educational Society)

Approved by AICTE, New Delhi & Affiliated to JNTUH, Hyderabad.

Kondapur (V), Ghatkesar (M), Medchal - Malkajgiri (D) - 501 301



ADD-ON COURSE ON

**“MATLAB FOR BEGINNERS”**

20<sup>TH</sup> JUL TO 30<sup>TH</sup> AUG, 2018

In collaboration with:

  
PRINCIPAL

Vignan's Institute of Management & Technology For Women,  
Kondapur (V), Ghatkesar (M), Medchal - Malkajgiri (D) - 501301  
Telangana State



**ELEGANT EMBEDDED SOLUTIONS PVT. LTD.**

**Duration of the Course: 37 Hrs**

Venue:

**'B'-Block Seminar Hall, VMTW.**

Organized By:

**DEPARTMENT OF ELECTRONICS AND  
COMMUNICATION ENGINEERING**





# VIGNAN'S INSTITUTE OF MANAGEMENT AND TECHNOLOGY FOR WOMEN

Sponsored by Lavu Educational Society, Approved by AICTE, New Delhi & Affiliated to JNTUH, Hyderabad.

Kondapur (V), Ghatkesar (M), Medchal - Malkajgiri (D) - 501 301 TS INDIA

Phone: +08615 200006/07/08

Email: info@vmtw.in

## DEPARTMENT OF ELECTRONICS AND COMMUNICATION ENGINEERING

ADD ON COURSE NAME: MATLAB for beginners

Academic Year: 2018-19

Date: 18-08-2018

B.Tech II-I SEM

DAY WISE SCHEDULE SHEET

SECTION: ECE-A&B

Room number: BFF6

S.no	DAY	Topic	Timings	Duration
1.	20-07-18	Environment setup	04:00pm to 05:00pm	1 hour
2.	21-07-18	Syntax	04:00pm to 05:00pm	1 hour
3.	23-07-18	Variables	04:00pm to 05:00pm	1 hour
4.	24-07-18	Commands	04:00pm to 05:00pm	1 hour
5.	25-07-18	Practice on Mat lab	04:00pm to 05:00pm	1 hour
6.	26-07-18	M-files	04:00pm to 05:00pm	1 hour
7.	27-07-18	Data	04:00pm to 05:00pm	1 hour
8.	28-07-18	Operators	04:00pm to 05:00pm	1 hour
9.	30-07-18	Decisions	04:00pm to 05:00pm	1 hour
10.	31-07-18	Practice on Mat lab	04:00pm to 05:00pm	1 hour
11.	01-08-18	Practice on Mat lab	04:00pm to 05:00pm	1 hour
12.	02-08-18	Loops	04:00pm to 05:00pm	1 hour
13.	03-08-18	Vectors	04:00pm to 05:00pm	1 hour
14.	04-08-18	Matrix	04:00pm to 05:00pm	1 hour
15.	06-08-18	Arrays	04:00pm to 05:00pm	1 hour
16.	07-08-18	Colon notation	04:00pm to 05:00pm	1 hour
17.	08-08-18	Numbers	04:00pm to 05:00pm	1 hour
18.	09-08-18	Strings	04:00pm to 05:00pm	1 hour
19.	10-08-18	Functions	04:00pm to 05:00pm	1 hour
20.	11-08-18	Data import	04:00pm to 05:00pm	1 hour
21.	13-08-18	Data output	04:00pm to 05:00pm	1 hour
22.	14-08-18	Plotting	04:00pm to 05:00pm	1 hour
23.	15-08-18	Graphics	04:00pm to 05:00pm	1 hour
24.	16-08-18	Algebra	04:00pm to 05:00pm	1 hour
25.	17-08-18	Calculus	04:00pm to 05:00pm	1 hour
26.	18-08-18	Differential	04:00pm to 05:00pm	1 hour
27.	20-08-18	Integration	04:00pm to 05:00pm	1 hour
28.	21-08-18	Polynomials	04:00pm to 05:00pm	1 hour
29.	22-08-18	Transforms	04:00pm to 05:00pm	1 hour
30.	23-08-18	Practice on Mat lab	04:00pm to 05:00pm	1 hour
31.	24-08-18	Practice on Mat lab	04:00pm to 05:00pm	1 hour
32.	25-08-18	GNU Octave	04:00pm to 05:00pm	1 hour



*[Signature]*  
PRINCIPAL

Vignani's Institute of Management & Technology for Women  
Kondapur(V), Ghatkesar(M), Medchal-Malkajgiri(D)-501301  
Telangana State

33.	26-08-18	Simulink	04:00pm to 05:00pm	1 hour
34.	27-08-18	Practice on Mat lab	04:00pm to 05:00pm	1 hour
35.	28-08-18	Practice on Mat lab	04:00pm to 05:00pm	1 hour
36.	29-08-18	Practice on Mat lab	04:00pm to 05:00pm	1 hour
37.	30-08-18	Test conducted and	04:00pm to 05:00pm	1 hour
<b>Total 37 hours</b>				

  
**Coordinator**

  
**HOD, ECE**

**Head of the Department**  
 Electronics and Communication Engineering  
 Vignan's Institute of Management and Technology for Women  
 Kondapur (V), Ghatkesar (M), R.R. Dist-501301



  
**PRINCIPAL**  
 Vignan's Institute of Management & Technology for Women  
 Kondapur(V), Ghatkesar(M), Medchal-Malkajgiri(D)-501301  
 Telangana State



# VIGNAN'S INSTITUTE OF MANAGEMENT AND TECHNOLOGY FOR WOMEN

Sponsored by Laxmi Educational Society, Approved by AICTE, New Delhi & Affiliated to JNTU/H, Hyderabad.  
Kondapur (V), Ghatkesar (M), Medchal - Malkajgiri (D) - 501 301 TS INDIA  
Phone: +08615 200006/07/08 Email: info@vmtw.in

## DEPARTMENT OF ELECTRONICS AND COMMUNICATION ENGINEERING

Academic Year: 2018-19

Date: 18-07-2018

ADD ON COURSE NAME: MATLAB for beginners

B.Tech II-I SEM

ADD ON COURSE REGISTRATION

SECTION: ECE-A

S.No	Roll number	Name of the student	Signature
1.	17UP1A0401	ANUMOJU SRAVANI	
2.	17UP1A0402	ATUKURI VIGNESHWARI	
3.	17UP1A0403	BABIREDDY NAINIKA REDDY	
4.	17UP1A0404	BASHETTI PRAVALIKA	
5.	17UP1A0405	BERE YASHASWINI	
6.	17UP1A0406	BONTHU RAMYA	
7.	17UP1A0407	CH DHARANI	
8.	17UP1A0408	CHEEMALA MOUNIKA	
9.	17UP1A0409	CHILUKA KAVYA SRI	
10.	17UP1A0410	CHINTAMKAR SAI PRIYA	
11.	17UP1A0411	CHINTHA BHAVITHA	
12.	17UP1A0412	CHOKKAM DIVYA	
13.	17UP1A0413	DHARNABOINA.ARCHANA	
14.	17UP1A0414	ELLENDULA VAISHANAVI	
15.	17UP1A0415	GOURLA SWETHA	
16.	17UP1A0416	JAKKULA BHUVI AKARSHA	
17.	17UP1A0417	K AKANKSHA REDDY	
18.	17UP1A0418	KALYANKAR HARIPRIYA	
19.	17UP1A0419	KODURU SOWMYA	
20.	17UP1A0420	KULSUM KHKNAM NAYYAR	
21.	17UP1A0421	KUNCHUPU JAHNAVI	
22.	17UP1A0422	M SRAVANTHI	
23.	17UP1A0423	M SREEJA	
24.	17UP1A0424	MAHESHWARAM PRAVALIKA	
25.	17UP1A0425	MANISHA MUTTAVARAPU	
26.	17UP1A0426	MODUGU MANISHA	
27.	17UP1A0427	NAGA SAI BHAVANI G	
28.	17UP1A0428	NALLAM ANJANA SRIVENI	
29.	17UP1A0429	NANDIGAMA NAVYA	
30.	17UP1A0430	P NANDINI	
31.	17UP1A0431	PABBATHI PRIYANKA	
32.	17UP1A0432	PAGALA RAMYA	
33.	17UP1A0433	PALADUGU SANDHYA	
34.	17UP1A0434	PANDLA SARAYU	



PRINCIPAL

Vignan's Institute of Management & Technology For Women  
Kondapur(V), Ghatkesar(M), Medchal - Malkajgiri(D) - 501301  
Telangana State

35.	17UP1A0435	PASHAM SHIVANI REDDY	<i>Suf</i>
36.	17UP1A0436	PATURI MANUSHA	<i>Manu</i>
37.	17UP1A0437	POLAGANI BHARGAVI	<i>bhargavi</i>
38.	17UP1A0438	POLICE PREETHI	<i>Preethi</i>
39.	17UP1A0439	POTALA SRAVYASRI	<i>Sravysri</i>
40.	17UP1A0440	POTLAPALLI DHARANI	---
41.	17UP1A0441	PULIGARI SHRAVYA	---
42.	17UP1A0442	PUNDRU KEERTHANA	<i>keerthana</i>
43.	17UP1A0443	PUSULLURI VASANTHI REDDY	<i>vasanthi</i>
44.	17UP1A0444	R SUBHIKSHA	<i>Sub</i>
45.	17UP1A0445	RACHABATTULA PRANAVA	<i>Pranava</i>
46.	17UP1A0446	RAMADASU SUSHMITHA	<i>Sush</i>
47.	17UP1A0447	S TEJA	<i>Teja</i>
48.	17UP1A0448	SUNKARI SOUMYA	<i>S</i>
49.	17UP1A0449	T YASASWI SOWMYA	<i>Soumya</i>
50.	17UP1A0450	UDUTHALA SHIVANI	<i>shivani</i>
51.	17UP1A0451	VAKITI SHIRISHA	<i>Shirishi</i>
52.	17UP1A0452	DEMIREDDY RAMYA SREE	<i>Ramya</i>

*[Signature]*  
COORDINATOR

*[Signature]*  
ECE.HOD

Head of the Department  
Electronics and Communication Engineering  
Women's Institute of Management & Technology For Women  
Kondapur (V), Ghatkesar (M), Medchal  
Malkajgiri (D) - 501301  
Telangana, India



*[Signature]*  
PRINCIPAL  
Women's Institute of Management & Technology For Women  
Kondapur (V), Ghatkesar (M), Medchal-Malkajgiri (D) - 501301  
Telangana, India



# VIGNAN'S INSTITUTE OF MANAGEMENT AND TECHNOLOGY FOR WOMEN

Sponsored by Levu Educational Society, Approved by AICTE, New Delhi & Affiliated to JNTUH, Hyderabad.  
Kondapur (V), Ghatkesar (M), Medchal - Malkajgiri (D) - 501 301 TS INDIA  
Phone: +08615 200006/07/08 Email: info@vmtw.in

## DEPARTMENT OF ELECTRONICS AND COMMUNICATION ENGINEERING

Academic Year: 2018-19

Date: 18-07-2018

### LIST OF REGISTERED STUDENTS

ADD ON COURSE NAME: MATLAB for beginners

B.Tech II-I SEM

SECTION: ECE-A

S.No	Roll number	Name of the student
1.	17UP1A0401	ANUMOJU SRAVANI
2.	17UP1A0402	ATUKURI VIGNESHWARI
3.	17UP1A0403	BABIREDDY NAINIKA REDDY
4.	17UP1A0404	BASHETTI PRAVALIKA
5.	17UP1A0405	BERE YASHASWINI
6.	17UP1A0406	BONTHU RAMYA
7.	17UP1A0407	CH DHARANI
8.	17UP1A0408	CHEEMALA MOUNIKA
9.	17UP1A0409	CHILUKA KAVYA SRI
10.	17UP1A0411	CHINTHA BHAVITHA
11.	17UP1A0412	CHOKKAM DIVYA
12.	17UP1A0413	DHARNABOINA.ARCHANA
13.	17UP1A0414	ELLENDULA VAISHANAVI
14.	17UP1A0415	GOURLA SWETHA
15.	17UP1A0416	JAKKULA BHUVI AKARSHA
16.	17UP1A0417	K AKANKSHA REDDY
17.	17UP1A0418	KALYANKAR HARIPRIYA
18.	17UP1A0419	KODURU SOWMYA
19.	17UP1A0420	KULSUM KHKNAM NAYYAR
20.	17UP1A0421	KUNCHUPU JAHNAVI
21.	17UP1A0422	M SRAVANTHI
22.	17UP1A0423	M SREEJA
23.	17UP1A0424	MAHESHWARAM PRAVALIKA
24.	17UP1A0426	MODUGU MANISHA
25.	17UP1A0427	NAGA SAI BHAVANI G
26.	17UP1A0428	NALLAM ANJANA SRIVENI
27.	17UP1A0429	NANDIGAMA NAVYA
28.	17UP1A0430	P NANDINI
29.	17UP1A0431	PABBATHI PRIYANKA
30.	17UP1A0432	PAGALA RAMYA



*[Signature]*  
PRINCIPAL  
Vignans Institute of Management & Technology For Women  
Kondapur(V), Ghatkesar(M), Medchal-Malkajgiri(D)-501301  
Telengana State

31.	17UP1A0433	PALADUGU SANDHYA
32.	17UP1A0434	PANDLA SARAYU
33.	17UP1A0435	PASHAM SHIVANI REDDY
34.	17UP1A0436	PATURI MANUSHA
35.	17UP1A0437	POLAGANI BHARGAVI
36.	17UP1A0438	POLICE PREETHI
37.	17UP1A0439	POTALA SRAVYASRI
38.	17UP1A0442	PUNDRU KEERTHANA
39.	17UP1A0443	PUSULLURI VASANTHI REDDY
40.	17UP1A0444	R SUBHIKSHA
41.	17UP1A0445	RACHABATTULA PRANAVA
42.	17UP1A0446	RAMADASU SUSHMITHA
43.	17UP1A0447	S TEJA
44.	17UP1A0448	SUNKARI SOUMYA
45.	17UP1A0449	T SOWMYA
46.	17UP1A0450	UDUTHALA SHIVANI
47.	17UP1A0451	VAKITI SHIRISHA
48.	17UP1A0452	VEMIREDDY RAMYASREE

  
COORDINATOR

  
HOD

Head of the Department  
Electronics and Communication Engineering  
Vignans Institute of Management and Technology for Women  
Kondapur (V), Ghatkesar (M), R.R. Dist-501 301



  
PRINCIPAL  
Vignans Institute of Management & Technology For Women  
Kondapur(V), Ghatkesar(M), Medchal-Meikarji(Or)-501301  
Telangana State



# VIGNAN'S INSTITUTE OF MANAGEMENT AND TECHNOLOGY FOR WOMEN

Sponsored by Lavu Educational Society, Approved by AICTE, New Delhi & Affiliated to JNTUH, Hyderabad.  
Kondapur (V), Ghatkesar (M), Medchal - Malkajgiri (D) - 501 301 TS INDIA  
Phone: +08815 200006/07/08 Email: info@vmtw.in

## DEPARTMENT OF ELECTRONICS AND COMMUNICATION ENGINEERING

Academic Year: 2018-19

Date: 18-07-2018

ADD ON COURSE NAME: MATLAB for beginners

B.Tech II-I SEM

ADD ON COURSE REGISTRATION FORM

SECTION: ECE-B

S.No	Roll number	Name of the student	Signature
1.	17UP1A0454	ANKAPURAM VARSHA	Varsha
2.	17UP1A0455	AYESHA NAFEEZ	Naf
3.	17UP1A0456	BADDAM SANGEETHA	Sang
4.	17UP1A0457	BATHINI UDHAYASRI	Sri
5.	17UP1A0458	B GEETHA CHANDANA	chand
6.	17UP1A0459	CHAMA HARINI	HA
7.	17UP1A0460	CHILUKURI ANJALI	Anj
8.	17UP1A0461	CHITYALA HIMAJA	HUJ
9.	17UP1A0462	DODDA NIHARIKA	
10.	17UP1A0463	GOTTUMUKULA PRANITHA	Pranitha
11.	17UP1A0464	GUDIPATHI PRANITHA	Pranitha
12.	17UP1A0465	G VENKATAKRISHNAVENI	Venka
13.	17UP1A0466	KESARA SUCHARITHA	Su
14.	17UP1A0467	KOMATRIREDDY JHANSI	JH
15.	17UP1A0468	KONDA SANJANA	Sanj
16.	17UP1A0469	KONDURU HARSHITHA	Har
17.	17UP1A0470	KUDIDHI SUSHMA	Sushma
18.	17UP1A0471	KUKKADAPU PRAVALLIKA	Pravallika
19.	17UP1A0472	MADDIRALA VASAVI	Vas
20.	17UP1A0473	MAHENDRAKAR RACHANA	Rach
21.	17UP1A0474	MAMILLAPALLY MOUNIKA	Mounika
22.	17UP1A0475	MUKUNDU MOUNIKA	Mounika
23.	17UP1A0476	MUSHNAM REVATHI	
24.	17UP1A0477	NACHU CHAITRA	Chai
25.	17UP1A0478	PAILLA SNEHA	Sne
26.	17UP1A0479	PANJALA HIMA SANTOSHINI	Hima
27.	17UP1A0480	PATLOLLA AKHILA	Akh
28.	17UP1A0481	PEDDAMAGARI SWATHI	Swathi
29.	17UP1A0482	POLNEEDI KAVYA SRI	Kavya



*Vignans*  
PRINCIPAL  
Vignans Institute of Management & Technology For Women  
Kondapur (V), Ghatkesar (M), Medchal - Malkajgiri (D) - 501 301  
Telangana, India

30.	17UP1A0483	PREETHIKA	<i>Pink</i> Satwika
31.	17UP1A0484	PUCHAKAYALA SATWIKA	<i>My</i>
32.	17UP1A0485	PULLURI MADHURI	<hr/>
33.	17UP1A0486	R INDUMANI	
34.	17UP1A0487	R VANI	<i>Vani</i>
35.	17UP1A0488	RAMANAKOL PRIYANKA	<i>Priya</i>
36.	17UP1A0489	SHYAM REDDY VARSHA	<i>Varsha</i>
37.	17UP1A0490	SINGIDI PUJITHA	<i>Pujitha</i>
38.	17UP1A0491	S KEERTHY EVANGELINE	<i>Kee</i>
39.	17UP1A0492	SOORISHETTY SUKEERTHI	<i>Sue</i>
40.	17UP1A0493	SODHA ANUSHA	<i>Anu</i>
41.	17UP1A0494	AMRUTHA VARSHINI	<i>Varshini</i>
42.	17UP1A0495	SUKKA SAHITHI	<i>Sahithi</i>
43.	17UP1A0496	TELU NIKITHA	<i>Niki</i>
44.	17UP1A0497	THAGIRA SAI PRIYA	<i>Sai Priya</i>
45.	17UP1A0498	UPPULURI SHYAMALA SESHADRI	<i>Sesh</i>
46.	17UP1A0499	VAVILIKOLANU CHANDANA	<i>Chandu</i>
47.	17UP1A04A0	VEERAMALLA PRATHYUSHA	<i>Prathyusha</i>
48.	17UP1A04A1	VELMA VYSHNAVI REDDY	<i>Vyshna</i>
49.	18UP5A0401	BUSHABOINA SHRAVYA	<i>Shru</i>
50.	18UP5A0402	HAFSA SUBHI	<i>Subhi</i>
51.	18UP5A0403	KORNI MADHAVI	<i>Madhavi</i>

*GH*

COORDINATOR

*HO*

HOD

Head of the Department  
Electronics and Communication Engineering  
VIT Women's Institute of Management & Technology For Women  
Kondapur (V), Ghatakasur (M), Medchal-Malkajgiri (Dt)-501301  
T.S.



*ASH*  
PRINCIPAL

VIT Women's Institute of Management & Technology For Women  
Kondapur (V), Ghatakasur (M), Medchal-Malkajgiri (Dt)-501301  
Telangana State





## VIGNAN'S INSTITUTE OF MANAGEMENT AND TECHNOLOGY FOR WOMEN

Sponsored by Lavu Educational Society, Approved by AICTE, New Delhi & Affiliated to JNTUH, Hyderabad.  
Kondapur (V), Ghatkesar (M), Medchal - Malkajgiri (D) - 501 301 TS INDIA  
Phone: +08615 2000607/08 Email: info@vmtw.in

### DEPARTMENT OF ELECTRONICS AND COMMUNICATION ENGINEERING

Academic Year: 2018-19

Date: 18-07-2018

#### LIST OF REGISTERED STUDENTS

ADD ON COURSE NAME: MATLAB for beginners

B.Tech II-I SEM ADD ON COURSE REGISTRATION FORM SECTION: ECE-B

S.No	Roll number	Name of the student
1.	17UP1A0454	ANKAPURAM VARSHA
2.	17UP1A0455	AYESHA NAFEEZ
3.	17UP1A0456	BADDAM SANGEETHA
4.	17UP1A0457	BATHINI UDHAYASRI
5.	17UP1A0458	B GEETHA CHANDANA
6.	17UP1A0459	CHAMA HARINI
7.	17UP1A0460	CHILUKURI ANJALI
8.	17UP1A0461	CHITYALA HIMAJA
9.	17UP1A0463	GOTTUMUKULA PRANITHA
10.	17UP1A0464	GUDIPATHI PRANITHA
11.	17UP1A0465	GVENKATAKRISHNAVENI
12.	17UP1A0466	KESARA SUCHARITHA
13.	17UP1A0467	KOMATRIREDDY JHANSI
14.	17UP1A0468	KONDA SANJANA
15.	17UP1A0469	KONDURU HARSHITHA
16.	17UP1A0470	KUDIDHI SUSHMA
17.	17UP1A0471	KUKKADAPU PRAVALLIKA
18.	17UP1A0472	MADDIRALA VASAVI
19.	17UP1A0473	MAHENDRAKAR RACHANA
20.	17UP1A0474	MAMILLAPALLY MOUNIKA
21.	17UP1A0475	MUKUNDU MOUNIKA
22.	17UP1A0477	NACHU CHAITRA
23.	17UP1A0478	PAILLA SNEHA
24.	17UP1A0479	PANJALA HIMA SANTOSHINI
25.	17UP1A0480	PATLOLLA AKHILA
26.	17UP1A0481	PEDDAMAGARI SWATHI
27.	17UP1A0482	POLNEEDI KAVYA SRI



  
PRINCIPAL

Vignan's Institute of Management & Technology For Women  
Kondapur(V), Ghatkesar(M), Medchal-Malkajgiri(D)-501301  
Telangana State

28.	17UP1A0483	PREETHIKA
29.	17UP1A0484	PUCHAKAYALA SATWIKA
30.	17UP1A0485	PULLURI MADHURI
31.	17UP1A0487	R VANI
32.	17UP1A0488	RAMANAKOL PRIYANKA
33.	17UP1A0489	SHYAM REDDY VARSHA
34.	17UP1A0490	SINGIDI PUJITHA
35.	17UP1A0491	S KEERTHY EVANGELINE
36.	17UP1A0493	SODHA ANUSHA
37.	17UP1A0494	SAMRUTHA VARSHINI
38.	17UP1A0495	SUKKA SAHITHI
39.	17UP1A0496	TELU NIKITHA
40.	17UP1A0497	THAGIRA SAI PRIYA
41.	17UP1A0498	UPPULURI SHYAMALA SESHADRI
42.	17UP1A0499	VAVILIKOLANU CHANDANA
43.	17UP1A04A0	VEERAMALLA PRATHYUSHA
44.	17UP1A04A1	VELMA VYSHNAVI REDDY
45.	18UP5A0401	BUSHABOINA SHRAVYA
46.	18UP5A0402	HAFSA SUBHI
47.	18UP5A0403	KORNI MADHAVI

  
COORDINATOR

  
HOD

Head of the Department  
Electronics and Communication Engineering  
Vignana Institute of Management and Technology for Women  
Kondapur (V), Ghatkesar (M), R.R. Dist-501 301



  
PRINCIPAL  
Vignana Institute of Management & Technology For Women  
Kondapur(V),Ghatkesar(M),Medchal-Malkajgiri(Dt)-501301  
Telangana State



# VIGNAN'S INSTITUTE OF MANAGEMENT AND TECHNOLOGY FOR WOMEN

Sponsored by Lavu Educational Society, Approved by AICTE, New Delhi & Affiliated to JNTUH, Hyderabad.  
Kondapur (V), Ghatkesar (M), Medchal - Malkajgiri (D) - 501 301 TS INDIA  
Phone: +08615 200006/07/08 Email: info@vmtw.in

## DEPARTMENT OF ELECTRONICS AND COMMUNICATION ENGINEERING

ADD ON COURSE NAME: MATLAB for beginners

Academic Year: 2018-19

Date: 20-07-2018

B.Tech II-I SEM

DAY WISE ATTENDANCE SHEET

SECTION: ECE-A

S.No	Roll number	20-07-18	21-07-18	23-07-18	24-07-18	25-07-18
1.	17UP1A0401	Ref	Ref	Ref	Ref	Ref
2.	17UP1A0402	Vigneshwari	Vigneshwari	Vigneshwari	Vigneshwari	Vigneshwari
3.	17UP1A0403	Ref	Ref	Ref	Ref	Ref
4.	17UP1A0404	Ref	Ref	Ref	Ref	Ref
5.	17UP1A0405	Yashu	Yashu	Yashu	Yashu	Yashu
6.	17UP1A0406	Ref	Ref	Ref	Ref	Ref
7.	17UP1A0407	Om	Om	Om	Om	Om
8.	17UP1A0408	Mouni	Mouni	Mouni	Mouni	Mouni
9.	17UP1A0409	Ref	Ref	Ref	Ref	Ref
10.	17UP1A0411	Beet	Beet	Beet	Beet	Beet
11.	17UP1A0412	DIVYA	DIVYA	DIVYA	DIVYA	DIVYA
12.	17UP1A0413	Archana	Archana	Archana	Archana	Archana
13.	17UP1A0414	Vaishu	Vaishu	Vaishu	Vaishu	Vaishu
14.	17UP1A0415	Surtha	Surtha	Surtha	Surtha	Surtha
15.	17UP1A0416	Ref	Ref	Ref	Ref	Ref
16.	17UP1A0417	Akanksha	Akanksha	Akanksha	Akanksha	Akanksha
17.	17UP1A0418	Haripriya	Haripriya	Haripriya	Haripriya	Haripriya
18.	17UP1A0419	Soumya	Soumya	Soumya	Soumya	Soumya
19.	17UP1A0420	Ref	Ref	Ref	Ref	Ref
20.	17UP1A0421	Jahnavi	Jahnavi	Jahnavi	Jahnavi	Jahnavi
21.	17UP1A0422	Ref	Ref	Ref	Ref	Ref
22.	17UP1A0423	Sree	Sree	Sree	Sree	Sree
23.	17UP1A0424	Ref	Ref	Ref	Ref	Ref
24.	17UP1A0426	Manisha	Manisha	Manisha	Manisha	Manisha
25.	17UP1A0427	Ref	Ref	Ref	Ref	Ref
26.	17UP1A0428	Sriveni	Sriveni	Sriveni	Sriveni	Sriveni
27.	17UP1A0429	Nanya	Nanya	Nanya	Nanya	Nanya
28.	17UP1A0430	Nandhu	Nandhu	Nandhu	Nandhu	Nandhu
29.	17UP1A0431	Ref	Ref	Ref	Ref	Ref
30.	17UP1A0432	Ramys	Ramys	Ramys	Ramys	Ramys
31.	17UP1A0433	Ref	Ref	Ref	Ref	Ref
32.	17UP1A0434	Sarayu	Sarayu	Sarayu	Sarayu	Sarayu
33.	17UP1A0435	Ref	Ref	Ref	Ref	Ref



PRINCIPAL  
Vignans Institute of Management & Technology for Women  
Kondapur (V), Ghatkesar (M), Medchal - Malkajgiri (D) - 501301  
Telangana State

34.	17UPIA0436	<del>Manu</del>	<del>Manu</del>	<del>Manu</del>	<del>Manu</del>	<del>Manu</del>
35.	17UPIA0437	bhargavi	bhargavi	bhargavi	bhargavi	bhargavi
36.	17UPIA0438	Preethi	Preethi	Preethi	Preethi	Preethi
37.	17UPIA0439	Saavyasani	Saavyasani	Saavyasani	Saavyasani	Saavyasani
38.	17UPIA0442	keerthana	keerthana	keerthana	keerthana	keerthana
39.	17UPIA0443	vasanthi	vasanthi	vasanthi	vasanthi	vasanthi
40.	17UPIA0444	<del>Sanu</del>	<del>Sanu</del>	<del>Sanu</del>	<del>Sanu</del>	<del>Sanu</del>
41.	17UPIA0445	Pranava	Pranava	Pranava	Pranava	Pranava
42.	17UPIA0446	<del>S</del>	<del>S</del>	<del>S</del>	<del>S</del>	<del>S</del>
43.	17UPIA0447	teja	teja	teja	teja	teja
44.	17UPIA0448	<del>S</del>	<del>S</del>	<del>S</del>	<del>S</del>	<del>S</del>
45.	17UPIA0449	soumya	soumya	soumya	soumya	soumya
46.	17UPIA0450	shivani	shivani	shivani	shivani	shivani
47.	17UPIA0451	shrey	shrey	shrey	shrey	shrey
48.	17UPIA0452	sanu	sanu	sanu	sanu	sanu

  
COORDINATOR

  
HOD

Head of the Department  
Electronics and Communication Engineering  
Vignans Institute of Management and Technology For Women  
Kondapur (V), Ghatkesar (M), Medchal-Malkajgiri (Dt) - 501301  
T.S.



  
PRINCIPAL  
Vignans Institute of Management & Technology For Women  
Kondapur(V), Ghatkesar(M), Medchal-Malkajgiri(Dt)-501301  
Telangana State



# VIGNAN'S INSTITUTE OF MANAGEMENT AND TECHNOLOGY FOR WOMEN

Sponsored by Lavu Educational Society, Approved by AICTE, New Delhi & Affiliated to INTUH, Hyderabad.

Kondapur (V), Ghatkesar (M), Medchal - Malkajgiri (D) - 501 301 TS INDIA

Phone: +08615 200008/07/08

Email: info@vmtw.in

## DEPARTMENT OF ELECTRONICS AND COMMUNICATION ENGINEERING

ADD ON COURSE NAME: MATLAB for beginners

Academic Year: 2018-19

Date: 20-07-2018

B.Tech II-I SEM

DAY WISE ATTENDANCE SHEET

SECTION: ECE-B

S.No	Roll number	20-07-18	21-07-18	23-07-18	24-07-18	25-07-18
1.	17UPIA0454	varsha	varsha	varsha	varsha	varsha
2.	17UPIA0455	Nat	Nat	Nat	Nat	Nat
3.	17UPIA0456	Sant	Sant	Sant	Sant	Sant
4.	17UPIA0457	Sri	Sri	Sri	Sri	Sri
5.	17UPIA0458	chand	chand	chand	chand	chand
6.	17UPIA0459	At	At	At	At	At
7.	17UPIA0460	At	At	At	At	At
8.	17UPIA0461	Hit	Hit	Hit	Hit	Hit
9.	17UPIA0463	Pranitha	Pranitha	Pranitha	Pranitha	Pranitha
10.	17UPIA0464	Pranitha	Pranitha	Pranitha	Pranitha	Pranitha
11.	17UPIA0465	Venket	Venket	Venket	Venket	Venket
12.	17UPIA0466	At	At	At	At	At
13.	17UPIA0467	At	At	At	At	At
14.	17UPIA0468	Sant	Sant	Sant	Sant	Sant
15.	17UPIA0469	At	At	At	At	At
16.	17UPIA0470	Sant	Sant	Sant	Sant	Sant
17.	17UPIA0471	Pravallika	Pravallika	Pravallika	Pravallika	Pravallika
18.	17UPIA0472	Venket	Venket	Venket	Venket	Venket
19.	17UPIA0473	Ravi	Ravi	Ravi	Ravi	Ravi
20.	17UPIA0474	manika	manika	manika	manika	manika
21.	17UPIA0475	Meenaj	Meenaj	Meenaj	Meenaj	Meenaj
22.	17UPIA0477	At	At	At	At	At
23.	17UPIA0478	Sit	Sit	Sit	Sit	Sit
24.	17UPIA0479	Hima	Hima	Hima	Hima	Hima
25.	17UPIA0480	At	At	At	At	At
26.	17UPIA0481	swathi	swathi	swathi	swathi	swathi
27.	17UPIA0482	Varun	Varun	Varun	Varun	Varun
28.	17UPIA0483	Ravi	Ravi	Ravi	Ravi	Ravi
29.	17UPIA0484	Sahvika	Sahvika	Sahvika	Sahvika	Sahvika
30.	17UPIA0485	At	At	At	At	At
31.	17UPIA0487	Vait	Vait	Vait	Vait	Vait



  
PRINCIPAL

Vignana's Institute of Management & Technology For Women  
Kondapur(V), Ghatkesar(M), Medchal-Malkajgiri(D)-501301  
Telangana State

32.	17UP1A0488	<del>Varsha</del>	Varsha	<del>Varsha</del>	<del>Varsha</del>	<del>Varsha</del>
33.	17UP1A0489	Varsha	Varsha	Varsha	Varsha	Varsha
34.	17UP1A0490	Pujitha	Pujitha	Pujitha	Pujitha	Pujitha
35.	17UP1A0491	<del>Kw</del>	Kw	<del>Kw</del>	<del>Kw</del>	<del>Kw</del>
36.	17UP1A0493	<del>Aj</del>	Aj	<del>Aj</del>	<del>Aj</del>	<del>Aj</del>
37.	17UP1A0494	Varshini	Varshini	Varshini	Varshini	Varshini
38.	17UP1A0495	<del>Varshini</del>	Varshini	<del>Varshini</del>	<del>Varshini</del>	<del>Varshini</del>
39.	17UP1A0496	<del>Varshini</del>	Varshini	<del>Varshini</del>	<del>Varshini</del>	<del>Varshini</del>
40.	17UP1A0497	sai priya	sai priya	sai priya	sai priya	sai priya
41.	17UP1A0498	<del>Sesh</del>	Sesh	<del>Sesh</del>	<del>Sesh</del>	<del>Sesh</del>
42.	17UP1A0499	Chandu	Chandu	Chandu	Chandu	Chandu
43.	17UP1A04A0	Prathiyusha	Prathiyusha	Prathiyusha	Prathiyusha	Prathiyusha
44.	17UP1A04A1	Vishvesh	Vishvesh	Vishvesh	Vishvesh	Vishvesh
45.	18UP5A0401	<del>Subhi</del>	Subhi	<del>Subhi</del>	<del>Subhi</del>	<del>Subhi</del>
46.	18UP5A0402	SUBHI	SUBHI	SUBHI	SUBHI	SUBHI
47.	18UP5A0403	Madhavi	Madhavi	Madhavi	Madhavi	Madhavi

COORDINATOR

HOD

Head of the Department  
 Electronics and Communication Engineering  
 Vignn's Institute of Management and Technology For Women  
 Kondapur (V), Ghatkesar (M), Nellore (Dt)  
 Pin-501201.



PRINCIPAL

Vignn's Institute of Management & Technology For Women  
 Kondapur(V), Ghatkesar(M), Nellore (Dt)  
 Telangana State



# VIGNAN'S INSTITUTE OF MANAGEMENT AND TECHNOLOGY FOR WOMEN

Sponsored by Laxmi Educational Society, Approved by AICTE, New Delhi & Affiliated to JNTUK, Hyderabad.  
Kondapur (V), Ghatkesar (M), Medchal - Malkajgiri (D) - 501 301 TS INDIA  
Phone: +08815 2000807/08 Email: info@vmtw.in

## DEPARTMENT OF ELECTRONICS AND COMMUNICATION ENGINEERING

ADD ON COURSE NAME: Aspects of Micro Wave Antenna Design and its upcoming uses

Academic Year: 2018-19

Date: 26-07-2018

B.Tech II-I SEM

DAY WISE ATTENDANCE SHEET

SECTION: ECE-A

S.No	Roll number	26-07-18	27-07-18	28-07-18	30-07-18	31-07-18
1.	17UPIA0401	Ref	Ref	Ref	Ref	Ref
2.	17UPIA0402	Vigneshwari	Vigneshwari	Vigneshwari	Vigneshwari	Vigneshwari
3.	17UPIA0403	Ref	Ref	Ref	Ref	Ref
4.	17UPIA0404	Ref	Ref	Ref	Ref	Ref
5.	17UPIA0405	Yashu..	Yashu..	Yashu..	Yashu..	Yashu..
6.	17UPIA0406	Ref	Ref	Ref	Ref	Ref
7.	17UPIA0407	Ref	Ref	Ref	Ref	Ref
8.	17UPIA0408	Mouni	Mouni	Mouni	Mouni	Mouni
9.	17UPIA0409	Ref	Ref	Ref	Ref	Ref
10.	17UPIA0411	Ref	Ref	Ref	Ref	Ref
11.	17UPIA0412	DNYA	DNYA	DNYA	DNYA	DNYA
12.	17UPIA0413	Archana	Archana	Archana	Archana	Archana
13.	17UPIA0414	Vaishy	Vaishy	Vaishy	Vaishy	Vaishy
14.	17UPIA0415	Suetha	Suetha	Suetha	Suetha	Suetha
15.	17UPIA0416	Ref	Ref	Ref	Ref	Ref
16.	17UPIA0417	Akanksha	Akanksha	Akanksha	Akanksha	Akanksha
17.	17UPIA0418	Haripriya	Haripriya	Haripriya	Haripriya	Haripriya
18.	17UPIA0419	Sowmya	Sowmya	Sowmya	Sowmya	Sowmya
19.	17UPIA0420	Ref	Ref	Ref	Ref	Ref
20.	17UPIA0421	Jahnavi	Jahnavi	Jahnavi	Jahnavi	Jahnavi
21.	17UPIA0422	Ref	Ref	Ref	Ref	Ref
22.	17UPIA0423	Sree	Sree	Sree	Sree	Sree
23.	17UPIA0424	Ref	Ref	Ref	Ref	Ref
24.	17UPIA0426	Manisha	Manisha	Manisha	Manisha	Manisha
25.	17UPIA0427	Ref	Ref	Ref	Ref	Ref
26.	17UPIA0428	Sriveni	Sriveni	Sriveni	Sriveni	Sriveni
27.	17UPIA0429	namya	namya	namya	namya	namya
28.	17UPIA0430	Nandhu	Nandhu	Nandhu	Nandhu	Nandhu
29.	17UPIA0431	Ref	Ref	Ref	Ref	Ref
30.	17UPIA0432	Ramya	Ramya	Ramya	Ramya	Ramya
31.	17UPIA0433	Ref	Ref	Ref	Ref	Ref
32.	17UPIA0434	Saisayu	Saisayu	Saisayu	Saisayu	Saisayu
33.	17UPIA0435	Ref	Ref	Ref	Ref	Ref



  
PRINCIPAL  
Vignans Institute of Management & Technology for Women  
Kondapur (V), Ghatkesar (M), Medchal - Malkajgiri (D) - 501 301  
Telangana State

34.	17UPIA0436	Manu	Manu	Manu	Manu	Manu
35.	17UPIA0437	bhargavi	bhargavi	bhargavi	bhargavi	bhargavi
36.	17UPIA0438	Preeti	Preeti	Preeti	Preeti	Preeti
37.	17UPIA0439	Somyasri	Somyasri	Somyasri	Somyasri	Somyasri
38.	17UPIA0442	keerthana	keerthana	keerthana	keerthana	keerthana
39.	17UPIA0443	Vasanthi	Vasanthi	Vasanthi	Vasanthi	Vasanthi
40.	17UPIA0444	Shruti	Shruti	Shruti	Shruti	Shruti
41.	17UPIA0445	Pranava	Pranava	Pranava	Pranava	Pranava
42.	17UPIA0446	Leja	Leja	Leja	Leja	Leja
43.	17UPIA0447	Leja	Leja	Leja	Leja	Leja
44.	17UPIA0448	Leja	Leja	Leja	Leja	Leja
45.	17UPIA0449	soumya	soumya	soumya	soumya	soumya
46.	17UPIA0450	Shivani	Shivani	Shivani	Shivani	Shivani
47.	17UPIA0451	Shruti	Shruti	Shruti	Shruti	Shruti
48.	17UPIA0452	Rani	Rani	Rani	Rani	Rani

COORDINATOR

ECE, HOD

Head of the Department  
Electronics and Communication Engineering  
Women's Institute of Management and Technology For Women  
Kondapur (V), Ghatkesar (M), R.R. Dist-501 301



PRINCIPAL

Women's Institute of Management & Technology For Women  
Kondapur (V), Ghatkesar (M), R.R. Dist-501 301  
T.S.





# VIGNAN'S INSTITUTE OF MANAGEMENT AND TECHNOLOGY FOR WOMEN

Sponsored by Law Educational Society, Approved by AICTE, New Delhi & Affiliated to JNTUH, Hyderabad.  
Kondapur (V), Ghatkesar (M), Medchal - Malkajgiri (D) - 501 301 TS INDIA  
Phone: +08615 20006/07/08 Email: info@vmtw.in

## DEPARTMENT OF ELECTRONICS AND COMMUNICATION ENGINEERING

ADD ON COURSE NAME: Aspects of Micro Wave Antenna Design and its upcoming uses

Academic Year: 2018-19

Date: 26-01-2019

B.Tech II-I SEM

DAY WISE ATTENDANCE SHEET

SECTION: ECE-B

S.No	Roll number	26-07-18	27-07-18	28-07-18	30-07-18	31-07-18
1.	17UP1A0454	Vaaha	Vaaha	Vaaha	Vaaha	Vaaha
2.	17UP1A0455	Nat	Nat	Nat	Nat	Nat
3.	17UP1A0456	Carth	Carth	Carth	Carth	Carth
4.	17UP1A0457	Sri	Sri	Sri	Sri	Sri
5.	17UP1A0458	chand	chand	chand	chand	chand
6.	17UP1A0459	Pr	Pr	Pr	Pr	Pr
7.	17UP1A0460	Pr	Pr	Pr	Pr	Pr
8.	17UP1A0461	Hil	Hil	Hil	Hil	Hil
9.	17UP1A0463	Pranitha	Pranitha	Pranitha	Pranitha	Pranitha
10.	17UP1A0464	Pranitha	Pranitha	Pranitha	Pranitha	Pranitha
11.	17UP1A0465	venet	venet	venet	venet	venet
12.	17UP1A0466	Pr	Pr	Pr	Pr	Pr
13.	17UP1A0467	Pr	Pr	Pr	Pr	Pr
14.	17UP1A0468	sanj	sanj	sanj	sanj	sanj
15.	17UP1A0469	Pr	Pr	Pr	Pr	Pr
16.	17UP1A0470	Sul	Sul	Sul	Sul	Sul
17.	17UP1A0471	Pravallika	Pravallika	Pravallika	Pravallika	Pravallika
18.	17UP1A0472	Vul	Vul	Vul	Vul	Vul
19.	17UP1A0473	Ravi	Ravi	Ravi	Ravi	Ravi
20.	17UP1A0474	manica	manica	manica	manica	manica
21.	17UP1A0475	Meenal	Meenal	Meenal	Meenal	Meenal
22.	17UP1A0477	Sit	Sit	Sit	Sit	Sit
23.	17UP1A0478	sneha	sneha	sneha	sneha	sneha
24.	17UP1A0479	Hima	Hima	Hima	Hima	Hima
25.	17UP1A0480	Pr	Pr	Pr	Pr	Pr
26.	17UP1A0481	swathi	swathi	swathi	swathi	swathi
27.	17UP1A0482	Kanup	Kanup	Kanup	Kanup	Kanup
28.	17UP1A0483	Pr	Pr	Pr	Pr	Pr
29.	17UP1A0484	satwika	satwika	satwika	satwika	satwika
30.	17UP1A0485	Pr	Pr	Pr	Pr	Pr
31.	17UP1A0487	Vani	Vani	Vani	Vani	Vani



  
PRINCIPAL  
Vignans Institute of Management & Technology for Women  
Kondapur(V), Ghatkesar(M), Medchal-Malkajgiri(D)-501301  
Telangana State

32.	17UP1A0488	Past	Past	Past	Past	Past
33.	17UP1A0489	Vaasha	Verasha	Vaasha	Vaasha	Vaasha
34.	17UP1A0490	Ajitha	Pujitha	pujitha	pujitha	Pujitha
35.	17UP1A0491	Ku	Ku	Ku	Ku	Ku
36.	17UP1A0493	Ay	Ay	Ay	Ay	Ay
37.	17UP1A0494	Vaishini	Vaishini	Vaishini	Vaishini	Vaishini
38.	17UP1A0495	Ay	Ay	Ay	Ay	Ay
39.	17UP1A0496	Ay	Ay	Ay	Ay	Ay
40.	17UP1A0497	sai priya	sai priya	sai priya	sai priya	sai priya
41.	17UP1A0498	Sesh	Sesh	Sesh	Sesh	Sesh
42.	17UP1A0499	Chandu	Chandu	Chandu	Chandu	Chandu
43.	17UP1A04A0	Prathyusha	Prathyusha	Prathyusha	Prathyusha	Prathyusha
44.	17UP1A04A1	Vishvesh	Vishvesh	Vishvesh	Vishvesh	Vishvesh
45.	18UP5A0401	Shri	Shri	Shri	Shri	Shri
46.	18UP5A0402	SUBHI	SUBHI	SUBHI	SUBHI	SUBHI
47.	18UP5A0403	Madhavi	Madhavi	Madhavi	Madhavi	Madhavi

*[Handwritten Signature]*

COORDINATOR

*[Handwritten Signature]*

HOD

Head of the Department  
 Electronics and Communication Engineering  
 Vignan's Institute of Management and Technology For Women  
 Kondapur (V), Ghatkesar (M), R.R. Dist-501 301



*[Handwritten Signature]*  
 PRINCIPAL

Vignan's Institute of Management & Technology For Women  
 Kondapur(V), Ghatkesar(M), Medchal-Nalgonda(Dt)-501301  
 Telangana State



# VIGNAN'S INSTITUTE OF MANAGEMENT AND TECHNOLOGY FOR WOMEN

Sponsored by Law Educational Society, Approved by AICTE, New Delhi & Affiliated to JNTUH, Hyderabad  
Kondapur (V), Ghatkesar (M), Medchal - Malkajgiri (D) - 501 301 TS INDIA  
Phone: +08815 2000607/08 Email: info@vmtw.in

## DEPARTMENT OF ELECTRONICS AND COMMUNICATION ENGINEERING

ADD ON COURSE NAME: MATLAB for beginners

Academic Year: 2018-19

Date: 01-08-2018

B.Tech II-I SEM

DAY WISE ATTENDANCE SHEET

SECTION: ECE-A

S.No	Roll number	01-08-18	02-08-18	03-08-18	04-08-18	05-08-18
1.	17UP1A0401	Ref	Ref	Ref	Ref	Ref
2.	17UP1A0402	Vigneshwari	Vigneshwari	Vigneshwari	Vigneshwari	Vigneshwari
3.	17UP1A0403	Ref	Ref	Ref	Ref	Ref
4.	17UP1A0404	Pmt	Pmt	Pmt	Pmt	Pmt
5.	17UP1A0405	Yashu..	Yashu..	Yashu..	Yashu..	Yashu..
6.	17UP1A0406	Ref	Ref	Ref	Ref	Ref
7.	17UP1A0407	Omj	Omj	Omj	Omj	Omj
8.	17UP1A0408	Mouni	Mouni	Mouni	Mouni	Mouni
9.	17UP1A0409	Ref	Ref	Ref	Ref	Ref
10.	17UP1A0411	But	But	But	But	But
11.	17UP1A0412	DIVYA	DIVYA	DIVYA	DIVYA	DIVYA
12.	17UP1A0413	Archana	Archana	Archana	Archana	Archana
13.	17UP1A0414	Vaishy	Vaishy	Vaishy	Vaishy	Vaishy
14.	17UP1A0415	Swetha	Swetha	Swetha	Swetha	Swetha
15.	17UP1A0416	At	At	At	At	At
16.	17UP1A0417	Akanksha	Akanksha	Akanksha	Akanksha	Akanksha
17.	17UP1A0418	Haripriya	Haripriya	Haripriya	Haripriya	Haripriya
18.	17UP1A0419	Sowmya	Sowmya	Sowmya	Sowmya	Sowmya
19.	17UP1A0420	Ref	Ref	Ref	Ref	Ref
20.	17UP1A0421	Jahnavi	Jahnavi	Jahnavi	Jahnavi	Jahnavi
21.	17UP1A0422	Ref	Ref	Ref	Ref	Ref
22.	17UP1A0423	Sree	Sree	Sree	Sree	Sree
23.	17UP1A0424	Pt	Pt	Pt	Pt	Pt
24.	17UP1A0426	Manisha	Manisha	Manisha	Manisha	Manisha
25.	17UP1A0427	But	But	But	But	But
26.	17UP1A0428	sriveni	sriveni	sriveni	sriveni	sriveni
27.	17UP1A0429	namya	namya	namya	namya	namya
28.	17UP1A0430	Nandhu	Nandhu	Nandhu	Nandhu	Nandhu
29.	17UP1A0431	Ref	Ref	Ref	Ref	Ref
30.	17UP1A0432	Ramys	Ramys	Ramys	Ramys	Ramys
31.	17UP1A0433	Ref	Ref	Ref	Ref	Ref
32.	17UP1A0434	Seesayu	Seesayu	Seesayu	Seesayu	Seesayu
33.	17UP1A0435	Ref	Ref	Ref	Ref	Ref



  
PRINCIPAL

Vignans Institute of Management & Technology For Women  
Kondapur (V), Ghatkesar (M), Medchal - Malkajgiri (D) - 501 301  
Telangana State

34.	17UP1A0436	Mammy	Mammy	Mammy	Mammy	Mammy
35.	17UP1A0437	bhargavi	bhargavi	bhargavi	bhargavi	bhargavi
36.	17UP1A0438	Preethi	Preethi	Preethi	Preethi	Preethi
37.	17UP1A0439	Saavyasri	Saavyasri	Saavyasri	Saavyasri	Saavyasri
38.	17UP1A0442	keerthana	keerthana	keerthana	keerthana	keerthana
39.	17UP1A0443	Vasanthi	Vasanthi	Vasanthi	Vasanthi	Vasanthi
40.	17UP1A0444	Pranava	Pranava	Pranava	Pranava	Pranava
41.	17UP1A0445	Pranava	Pranava	Pranava	Pranava	Pranava
42.	17UP1A0446	Leja	Leja	Leja	Leja	Leja
43.	17UP1A0447	Leja	Leja	Leja	Leja	Leja
44.	17UP1A0448	Leja	Leja	Leja	Leja	Leja
45.	17UP1A0449	Saavyasri	Saavyasri	Saavyasri	Saavyasri	Saavyasri
46.	17UP1A0450	Shivani	Shivani	Shivani	Shivani	Shivani
47.	17UP1A0451	Shivani	Shivani	Shivani	Shivani	Shivani
48.	17UP1A0452	Ranjit	Ranjit	Ranjit	Ranjit	Ranjit

  
COORDINATOR

  
HOD

Head of the Department  
Electronics and Communication Engineering  
Vignana Institute of Management and Technology for Women  
Nondapur (V), Ghatkesar (M), R.R. Dist-501 301



  
PRINCIPAL  
Vignana Institute of Management & Technology for Women  
Nondapur(V), Ghatkesar(M), Medchal-Malkajgiri(DI)-501301  
Telangana State



# VIGNAN'S INSTITUTE OF MANAGEMENT AND TECHNOLOGY FOR WOMEN

Sponsored by Lavu Educational Society, Approved by AICTE, New Delhi & Affiliated to JNTUH, Hyderabad.  
Kondapur (V), Ghatkesar (M), Medchal - Malkajgiri (D) - 501 301 TS INDIA  
Phone: +08615 200006/07/08 Email: info@vmtw.in

## DEPARTMENT OF ELECTRONICS AND COMMUNICATION ENGINEERING

ADD ON COURSE NAME: MATLAB for beginners

Academic Year: 2018-19

Date: 01-08-2018

B.Tech II-I SEM

DAY WISE ATTENDANCE SHEET

SECTION: ECE-B

S.No	Roll number	01-08-18	02-08-18	03-08-18	04-08-18	06-08-18
1.	17UP1A0454	Vaisha	Vaisha	Vaisha	Vaisha	Vaisha
2.	17UP1A0455	<del>not</del>	<del>not</del>	<del>not</del>	<del>not</del>	<del>not</del>
3.	17UP1A0456	Sanj	Sanj	Sanj	Sanj	Sanj
4.	17UP1A0457	Sri	Sri	Sri	Sri	Sri
5.	17UP1A0458	chansd	chansd	chansd	chansd	chansd
6.	17UP1A0459	<del>not</del>	<del>not</del>	<del>not</del>	<del>not</del>	<del>not</del>
7.	17UP1A0460	Ary	Ary	Ary	Ary	Ary
8.	17UP1A0461	Hil	Hil	Hil	Hil	Hil
9.	17UP1A0463	Pranitha	Pranitha	Pranitha	Pranitha	Pranitha
10.	17UP1A0464	Pranitha	Pranitha	Pranitha	Pranitha	Pranitha
11.	17UP1A0465	venet	venet	venet	venet	venet
12.	17UP1A0466	Sj	Sj	Sj	Sj	Sj
13.	17UP1A0467	Sj	Sj	Sj	Sj	Sj
14.	17UP1A0468	sanj	sanj	sanj	sanj	sanj
15.	17UP1A0469	Flor	Flor	Flor	Flor	Flor
16.	17UP1A0470	Sanj	Sanj	Sanj	Sanj	Sanj
17.	17UP1A0471	Pravallika	Pravallika	Pravallika	Pravallika	Pravallika
18.	17UP1A0472	Vani	Vani	Vani	Vani	Vani
19.	17UP1A0473	Ravi	Ravi	Ravi	Ravi	Ravi
20.	17UP1A0474	maurika	maurika	maurika	maurika	maurika
21.	17UP1A0475	Mousmi	Mousmi	Mousmi	Mousmi	Mousmi
22.	17UP1A0477	Sanj	Sanj	Sanj	Sanj	Sanj
23.	17UP1A0478	Sj	Sj	Sj	Sj	Sj
24.	17UP1A0479	flims	flims	flims	flims	flims
25.	17UP1A0480	Ary	Ary	Ary	Ary	Ary
26.	17UP1A0481	swathi	swathi	swathi	swathi	swathi
27.	17UP1A0482	sanj	sanj	sanj	sanj	sanj
28.	17UP1A0483	Ravi	Ravi	Ravi	Ravi	Ravi
29.	17UP1A0484	sahika	sahika	sahika	sahika	sahika
30.	17UP1A0485	Mit	Mit	Mit	Mit	Mit
31.	17UP1A0487	vait	vait	vait	vait	vait
32.	17UP1A0488	Pur	Pur	Pur	Pur	Pur
33.	17UP1A0489	Varsha	Varsha	Varsha	Varsha	Varsha



*[Signature]*  
PRINCIPAL  
Vignans Institute of Management & Technology For Women  
Kondapur(V), Ghatkesar(M), Medchal-Malkajgiri(D)-501301  
Telangana State

34.	17UPIA0490	Ajitha	Ajitha	Pujitha	Pujitha	Pujitha
35.	17UPIA0491	<del>Ru</del>	<del>Ru</del>	<del>Ru</del>	<del>Ru</del>	<del>Ru</del>
36.	17UPIA0493	<del>As</del>	<del>As</del>	<del>As</del>	<del>As</del>	<del>As</del>
37.	17UPIA0494	Vasshini	Vasshini	Vasshini	Vasshini	Vasshini
38.	17UPIA0495	<del>Sat</del>	<del>Sat</del>	<del>Sat</del>	<del>Sat</del>	<del>Sat</del>
39.	17UPIA0496	<del>As</del>	<del>As</del>	<del>As</del>	<del>As</del>	<del>As</del>
40.	17UPIA0497	sai priya	sai priya	sai priya	sai priya	sai priya
41.	17UPIA0498	<del>Sas</del>	<del>Sas</del>	<del>Sas</del>	<del>Sas</del>	<del>Sas</del>
42.	17UPIA0499	Chandu	Chandu	Chandu	Chandu	Chandu
43.	17UPIA04A0	Prathiyusha	Prathiyusha	Prathiyusha	Prathiyusha	Prathiyusha
44.	17UPIA04A1	Vishves	Vishves	Vishves	Vishves	Vishves
45.	18UP5A0401	<del>Shy</del>	<del>Shy</del>	<del>Shy</del>	<del>Shy</del>	<del>Shy</del>
46.	18UP5A0402	SUBHI	SUBHI	SUBHI	SUBHI	SUBHI
47.	18UP5A0403	Madhavi	Madhavi	Madhavi	Madhavi	Madhavi

  
COORDINATOR

  
HOD

Head of the Department  
Electronics and Communication Engineering  
Vignana Institute of Management and Technology For Women  
Kondapur (V), Ghatkesar (M), R.R. Dist-501130



  
PRINCIPAL  
Vignana Institute of Management & Technology For Women  
Kondapur(V), Ghatkesar(M), Medchal-Malkajgiri(D)-501301  
Telangana State



# VIGNAN'S INSTITUTE OF MANAGEMENT AND TECHNOLOGY FOR WOMEN

Sponsored by Law Educational Society, Approved by AICTE, New Delhi & Affiliated to RUTU, Hyderabad.  
Kondapur (V), Ghatkesar (M), Medchal - Malkajgiri (D) - 501 301 TS INDIA  
Phone: +08615 200008/07/08 Email: info@vmbw.in

## DEPARTMENT OF ELECTRONICS AND COMMUNICATION ENGINEERING

ADD ON COURSE NAME: MATLAB for beginners

Academic Year: 2018-19

Date: 07-08-2018

B.Tech II-I SEM

DAY WISE ATTENDANCE SHEET

SECTION: ECE-A

S.No	Roll number	07-08-18	08-08-18	09-08-18	10-08-18	11-08-18
1.	17UPIA0401	Best	Best	Best	Best	Best
2.	17UPIA0402	Vigneshwari	Vigneshwari	Vigneshwari	Vigneshwari	Vigneshwari
3.	17UPIA0403	Best	Best	Best	Best	Best
4.	17UPIA0404	Best	Best	Best	Best	Best
5.	17UPIA0405	Yashu..	Yashu..	Yashu..	Yashu..	Yashu..
6.	17UPIA0406	Best	Best	Best	Best	Best
7.	17UPIA0407	Omj	Omj	Omj	Omj	Omj
8.	17UPIA0408	Mouni	Mouni	Mouni	Mouni	Mouni
9.	17UPIA0409	Best	Best	Best	Best	Best
10.	17UPIA0411	Best	Best	Best	Best	Best
11.	17UPIA0412	Divya	Divya	Divya	Divya	Divya
12.	17UPIA0413	Archana	Archana	Archana	Archana	Archana
13.	17UPIA0414	Vaishu	Vaishu	Vaishu	Vaishu	Vaishu
14.	17UPIA0415	Swetha	Swetha	Swetha	Swetha	Swetha
15.	17UPIA0416	Aj	Aj	Aj	Aj	Aj
16.	17UPIA0417	Akanksha	Akanksha	Akanksha	Akanksha	Akanksha
17.	17UPIA0418	Hari Priya	Hari Priya	Hari Priya	Hari Priya	Hari Priya
18.	17UPIA0419	Sowmya	Sowmya	Sowmya	Sowmya	Sowmya
19.	17UPIA0420	Best	Best	Best	Best	Best
20.	17UPIA0421	Jahnavi	Jahnavi	Jahnavi	Jahnavi	Jahnavi
21.	17UPIA0422	St	St	St	St	St
22.	17UPIA0423	Sree	Sree	Sree	Sree	Sree
23.	17UPIA0424	PA	PA	PA	PA	PA
24.	17UPIA0426	Manisha	Manisha	Manisha	Manisha	Manisha
25.	17UPIA0427	Best	Best	Best	Best	Best
26.	17UPIA0428	sriveni	sriveni	sriveni	sriveni	sriveni
27.	17UPIA0429	nanya	nanya	nanya	nanya	nanya
28.	17UPIA0430	Nandhu	Nandhu	Nandhu	Nandhu	Nandhu
29.	17UPIA0431	Prj	Prj	Prj	Prj	Prj
30.	17UPIA0432	Ranjya	Ranjya	Ranjya	Ranjya	Ranjya
31.	17UPIA0433	Best	Best	Best	Best	Best
32.	17UPIA0434	Sowmya	Sowmya	Sowmya	Sowmya	Sowmya
33.	17UPIA0435	Best	Best	Best	Best	Best



  
PRINCIPAL

Vignans Institute of Management & Technology for Women  
Kondapur(V), Ghatkesar(M), Medchal-Malkajgiri(D)-501301  
Telangana State

34.	17UP1A0436	<i>Mam</i>	<i>Mam</i>	<i>Mam</i>	<i>Mam</i>	<i>Mam</i>
35.	17UP1A0437	bhargavi	bhargavi	bhargavi	bhargavi	bhargavi
36.	17UP1A0438	Preethi	Preethi	Preethi	Preethi	Preethi
37.	17UP1A0439	Somyasri	Somyasri	Somyasri	Somyasri	Somyasri
38.	17UP1A0442	keerthana	keerthana	keerthana	keerthana	keerthana
39.	17UP1A0443	vasanthi	vasanthi	vasanthi	vasanthi	vasanthi
40.	17UP1A0444	<i>Sru</i>	<i>Sru</i>	<i>Sru</i>	<i>Sru</i>	<i>Sru</i>
41.	17UP1A0445	Pranava	Pranava	Pranava	Pranava	Pranava
42.	17UP1A0446	<i>S</i>	<i>S</i>	<i>S</i>	<i>S</i>	<i>S</i>
43.	17UP1A0447	Teja	Teja	Teja	Teja	Teja
44.	17UP1A0448	<i>S</i>	<i>S</i>	<i>S</i>	<i>S</i>	<i>S</i>
45.	17UP1A0449	sowmya	sowmya	sowmya	sowmya	sowmya
46.	17UP1A0450	Shivani	Shivani	Shivani	Shivani	Shivani
47.	17UP1A0451	Shri	Shri	Shri	Shri	Shri
48.	17UP1A0452	Ranj	Ranj	Ranj	Ranj	Ranj

COORDINATOR

HOD

Head of the Department  
 Electronic and Communication Engineering  
 Vignana's Institute of Management and Technology for Women  
 Kondapur (V), Ghatkesar (M), R.R. Dist-501301



PRINCIPAL

Vignana's Institute of Management & Technology for Women  
 Kondapur(V), Ghatkesar(M), Medchal-Malkajgiri(Dt)-501301  
 Telangana State





# VIGNAN'S INSTITUTE OF MANAGEMENT AND TECHNOLOGY FOR WOMEN

Sponsored by Lavu Educational Society, Approved by AICTE, New Delhi & Affiliated to JNTUH, Hyderabad.  
Kondapur (V), Ghatkesar (M), Medchal - Malkajgiri (D) - 501 301 TS INDIA.  
Phone: +08615 200005/07/08 Email: info@vnmw.in

## DEPARTMENT OF ELECTRONICS AND COMMUNICATION ENGINEERING

ADD ON COURSE NAME: MATLAB for beginners

Academic Year: 2018-19

Date: 07-08-2018

B.Tech II-I SEM

DAY WISE ATTENDANCE SHEET

SECTION: ECE-B

S.No	Roll number	07-08-18	08-08-18	09-08-18	10-08-18	11-08-18
1.	17UP1A0454	Varsha	Varsha	Varsha	Varsha	Varsha
2.	17UP1A0455	Nat	Nat	Nat	Nat	Nat
3.	17UP1A0456	Sant	Sant	Sant	Sant	Sant
4.	17UP1A0457	Sri	Sri	Sri	Sri	Sri
5.	17UP1A0458	Chand	Chand	Chand	Chand	Chand
6.	17UP1A0459	Pr	Pr	Pr	Pr	Pr
7.	17UP1A0460	Pr	Pr	Pr	Pr	Pr
8.	17UP1A0461	Pr	Pr	Pr	Pr	Pr
9.	17UP1A0463	Pranitha	Pranitha	Pranitha	Pranitha	Pranitha
10.	17UP1A0464	Pranitha	Pranitha	Pranitha	Pranitha	Pranitha
11.	17UP1A0465	Pranitha	Pranitha	Pranitha	Pranitha	Pranitha
12.	17UP1A0466	Pr	Pr	Pr	Pr	Pr
13.	17UP1A0467	Pr	Pr	Pr	Pr	Pr
14.	17UP1A0468	Sant	Sant	Sant	Sant	Sant
15.	17UP1A0469	Pr	Pr	Pr	Pr	Pr
16.	17UP1A0470	Pr	Pr	Pr	Pr	Pr
17.	17UP1A0471	Pravallika	Pravallika	Pravallika	Pravallika	Pravallika
18.	17UP1A0472	Pr	Pr	Pr	Pr	Pr
19.	17UP1A0473	Pr	Pr	Pr	Pr	Pr
20.	17UP1A0474	Pr	Pr	Pr	Pr	Pr
21.	17UP1A0475	Pr	Pr	Pr	Pr	Pr
22.	17UP1A0477	Pr	Pr	Pr	Pr	Pr
23.	17UP1A0478	Pr	Pr	Pr	Pr	Pr
24.	17UP1A0479	Pr	Pr	Pr	Pr	Pr
25.	17UP1A0480	Pr	Pr	Pr	Pr	Pr
26.	17UP1A0481	Swathi	Swathi	Swathi	Swathi	Swathi
27.	17UP1A0482	Pr	Pr	Pr	Pr	Pr
28.	17UP1A0483	Pr	Pr	Pr	Pr	Pr



  
PRINCIPAL

Vignans Institute of Management & Technology For Women  
Kondapur(V), Ghatkesar(M), Medchal - Malkajgiri(D) - 501 301  
Telangana State

29.	17UP1A0484	Sahwika	Sahwika	Sahwika	Sahwika	Sahwika
30.	17UP1A0485	Miy	Miy	Miy	Miy	Miy
31.	17UP1A0487	vait	vait	vait	vait	vait
32.	17UP1A0488	P-1	P-1	P-1	P-1	P-1
33.	17UP1A0489	Vassha	Vassha	Vassha	Vassha	Vassha
34.	17UP1A0490	Pujitha	Pujitha	Pujitha	Pujitha	Pujitha
35.	17UP1A0491	Ken	Ken	Ken	Ken	Ken
36.	17UP1A0493	A1	A1	A1	A1	A1
37.	17UP1A0494	Vasshini	Vasshini	Vasshini	Vasshini	Vasshini
38.	17UP1A0495	Sst	Sst	Sst	Sst	Sst
39.	17UP1A0496	Ny	Ny	Ny	Ny	Ny
40.	17UP1A0497	sai priya	sai priya	sai priya	sai priya	sai priya
41.	17UP1A0498	Ssh.	Ssh.	Ssh.	Ssh.	Ssh.
42.	17UP1A0499	Chandu	Chandu	Chandu	Chandu	Chandu
43.	17UP1A04A0	Prathiyusa	Prathiyusa	Prathiyusa	Prathiyusa	Prathiyusa
44.	17UP1A04A1	Vyshmes	Vyshmes	Vyshmes	Vyshmes	Vyshmes
45.	18UP5A0401	Shy	Shy	Shy	Shy	Shy
46.	18UP5A0402	SUBHI	SUBHI	SUBHI	SUBHI	SUBHI
47.	18UP5A0403	Madhavi	Madhavi	Madhavi	Madhavi	Madhavi

*Ny*

COORDINATOR

*A1*

HOD

Head of the Department  
Electronics and Communication Engineering  
Vignana Institute of Management and Technology For Women  
Kondapur (V), Ghatakaser (M), R.R. Dist-501301



*Vignana*  
PRINCIPAL

Vignana Institute of Management & Technology For Women  
Kondapur(V),Ghatakaser(M),Medchal-Malkajgiri(Dist-501301)  
Telangana State



# VIGNAN'S INSTITUTE OF MANAGEMENT AND TECHNOLOGY FOR WOMEN

Sponsored by Laxmi Educational Society, Approved by AICTE, New Delhi & Affiliated to INTUW, Hyderabad.  
Kondapur (V), Ghatkesar (M), Medchal - Malkajgiri (D) - 501 301 TS INDIA  
Phone: +08615 200006/07/08 Email: info@vmtw.in

## DEPARTMENT OF ELECTRONICS AND COMMUNICATION ENGINEERING

ADD ON COURSE NAME: MATLAB for beginners

Academic Year: 2018-19

Date: 13-08-2018

B.Tech II-I SEM

DAY WISE ATTENDANCE SHEET

SECTION: ECE-A

S.No	Roll number	13-08-18	14-08-18	15-08-18	16-08-18	17-08-18
1.	17UP1A0401	Ref	Ref	Ref	Ref	Ref
2.	17UP1A0402	Vigneshwari	Vigneshwari	Vigneshwari	Vigneshwari	Vigneshwari
3.	17UP1A0403	Ref	Ref	Ref	Ref	Ref
4.	17UP1A0404	Ref	Ref	Ref	Ref	Ref
5.	17UP1A0405	Yashu	Yashu	Yashu	Yashu	Yashu
6.	17UP1A0406	Ref	Ref	Ref	Ref	Ref
7.	17UP1A0407	Omni	Omni	Omni	Omni	Omni
8.	17UP1A0408	Mouni	Mouni	Mouni	Mouni	Mouni
9.	17UP1A0409	Ref	Ref	Ref	Ref	Ref
10.	17UP1A0411	Bunt	Bunt	Bunt	Bunt	Bunt
11.	17UP1A0412	DIVYA	DIVYA	DIVYA	DIVYA	DIVYA
12.	17UP1A0413	Archana	Archana	Archana	Archana	Archana
13.	17UP1A0414	Vaishu	Vaishu	Vaishu	Vaishu	Vaishu
14.	17UP1A0415	Sweetha	Sweetha	Sweetha	Sweetha	Sweetha
15.	17UP1A0416	A4	A4	A4	A4	A4
16.	17UP1A0417	Akanksha	Akanksha	Akanksha	Akanksha	Akanksha
17.	17UP1A0418	Haripriya	Haripriya	Haripriya	Haripriya	Haripriya
18.	17UP1A0419	Sowmya	Sowmya	Sowmya	Sowmya	Sowmya
19.	17UP1A0420	Ref	Ref	Ref	Ref	Ref
20.	17UP1A0421	Jahnvi	Jahnvi	Jahnvi	Jahnvi	Jahnvi
21.	17UP1A0422	S	S	S	S	S
22.	17UP1A0423	Sree	Sree	Sree	Sree	Sree
23.	17UP1A0424	PA	PA	PA	PA	PA
24.	17UP1A0426	Manisha	Manisha	Manisha	Manisha	Manisha
25.	17UP1A0427	Ref	Ref	Ref	Ref	Ref
26.	17UP1A0428	Sriveni	Sriveni	Sriveni	Sriveni	Sriveni
27.	17UP1A0429	Navya	Navya	Navya	Navya	Navya
28.	17UP1A0430	Nandhu	Nandhu	Nandhu	Nandhu	Nandhu
29.	17UP1A0431	Ref	Ref	Ref	Ref	Ref
30.	17UP1A0432	Ramys	Ramys	Ramys	Ramys	Ramys
31.	17UP1A0433	Ref	Ref	Ref	Ref	Ref
32.	17UP1A0434	Sarayu	Sarayu	Sarayu	Sarayu	Sarayu



*[Signature]*  
PRINCIPAL  
Vignans Institute of Management & Technology for Women  
Kondapur(V), Ghatkesar(M), Medchal - Malkajgiri(D) - 501 301  
Telangana State

33.	17UPIA0435	Sut	Sut	Sut	Sut	Sut
34.	17UPIA0436	Manal	Manal	Manal	Manal	Manal
35.	17UPIA0437	bhargavi	bhargavi	bhargavi	bhargavi	bhargavi
36.	17UPIA0438	Preethi	Preethi	Preethi	Preethi	Preethi
37.	17UPIA0439	Sravysa	Sravysa	Sravysa	Sravysa	Sravysa
38.	17UPIA0442	keerthana	keerthana	keerthana	keerthana	keerthana
39.	17UPIA0443	vasanthi	vasanthi	vasanthi	vasanthi	vasanthi
40.	17UPIA0444	Sud	Sud	Sud	Sud	Sud
41.	17UPIA0445	Panava	Panava	Panava	Panava	Panava
42.	17UPIA0446	S	S	S	S	S
43.	17UPIA0447	Lija	Lija	Lija	Lija	Lija
44.	17UPIA0448	S	S	S	S	S
45.	17UPIA0449	Sowmya	Sowmya	Sowmya	Sowmya	Sowmya
46.	17UPIA0450	Shivani	Shivani	Shivani	Shivani	Shivani
47.	17UPIA0451	Shrey	Shrey	Shrey	Shrey	Shrey
48.	17UPIA0452	Ram	Ram	Ram	Ram	Ram

*[Signature]*

COORDINATOR

*[Signature]*

ECE, HOD

Head of the Department  
Electronics and Communication Engineering  
Women's Institute of Management and Technology For Women  
Kondapur (V), Ghatkesar (M), Medchal  
Malkajgiri (D) Pin-501301



*[Signature]*  
PRINCIPAL

Women's Institute of Management & Technology For Women  
Kondapur (V), Ghatkesar (M), Medchal-Malkajgiri (D)  
Telangana State



# VIGNAN'S INSTITUTE OF MANAGEMENT AND TECHNOLOGY FOR WOMEN

(Sponsored by Levu Educational Society, Approved by AICTE, New Delhi & Affiliated to JNTUH, Hyderabad.)

Kondapur (V), Ghatkesar (M), Medchal - Malkajgiri (D) - 501 301 TS INDIA

Phone: +08415 200006/07/08

Email: info.vmtw.in

## DEPARTMENT OF ELECTRONICS AND COMMUNICATION ENGINEERING

ADD ON COURSE NAME: MATLAB for beginners

Academic Year: 2018-19

Date: 13-08-2018

B.Tech II-I SEM

DAY WISE ATTENDANCE SHEET

SECTION: ECE-B

S.No	Roll number	13-08-18	14-08-18	15-08-18	16-08-18	17-08-18
1.	17UPIA0454	Varsha	Varsha	Varsha	Varsha	Varsha
2.	17UPIA0455	Nas	Nas	Nas	Nas	Nas
3.	17UPIA0456	Sant	Sant	Sant	Sant	Sant
4.	17UPIA0457	Sri	Sri	Sri	Sri	Sri
5.	17UPIA0458	Chand	Chand	Chand	Chand	Chand
6.	17UPIA0459	#	#	#	#	#
7.	17UPIA0460	Put	Put	Put	Put	Put
8.	17UPIA0461	Him	Him	Him	Him	Him
9.	17UPIA0463	Pranitha	Pranitha	Pranitha	Pranitha	Pranitha
10.	17UPIA0464	Pranitha	Pranitha	Pranitha	Pranitha	Pranitha
11.	17UPIA0465	Venka	Venka	Venka	Venka	Venka
12.	17UPIA0466	Est	Est	Est	Est	Est
13.	17UPIA0467	Est	Est	Est	Est	Est
14.	17UPIA0468	Sant	Sant	Sant	Sant	Sant
15.	17UPIA0469	Hest	Hest	Hest	Hest	Hest
16.	17UPIA0470	Sushma	Sushma	Sushma	Sushma	Sushma
17.	17UPIA0471	Pravallika	Pravallika	Pravallika	Pravallika	Pravallika
18.	17UPIA0472	Ven	Ven	Ven	Ven	Ven
19.	17UPIA0473	Ravi	Ravi	Ravi	Ravi	Ravi
20.	17UPIA0474	mounika	mounika	mounika	mounika	mounika
21.	17UPIA0475	mouni	mouni	mouni	mouni	mouni
22.	17UPIA0477	Est	Est	Est	Est	Est
23.	17UPIA0478	Est	Est	Est	Est	Est
24.	17UPIA0479	Hima	Hima	Hima	Hima	Hima
25.	17UPIA0480	Est	Est	Est	Est	Est
26.	17UPIA0481	swathi	swathi	swathi	swathi	swathi
27.	17UPIA0482	Kavya	Kavya	Kavya	Kavya	Kavya
28.	17UPIA0483	Est	Est	Est	Est	Est
29.	17UPIA0484	sahwika	sahwika	sahwika	sahwika	sahwika
30.	17UPIA0485	Est	Est	Est	Est	Est
31.	17UPIA0487	Vaid	Vaid	Vaid	Vaid	Vaid



*[Signature]*  
PRINCIPAL

Vignans Institute of Management & Technology for Women  
Kondapur(V), Ghatkesar(M), Medchal-Malkajgiri(D)  
Telangana State

32.	17UPIA0488	<del>Pur</del>	<del>Pur</del>	<del>Pur</del>	<del>Pur</del>	<del>Pur</del>
33.	17UPIA0489	Varsha	Varsha	Varsha	Varsha	Varsha
34.	17UPIA0490	Pujitha	Pujitha	Pujitha	Pujitha	Pujitha
35.	17UPIA0491	<del>Pur</del>	<del>Pur</del>	<del>Pur</del>	<del>Pur</del>	<del>Pur</del>
36.	17UPIA0493	<del>Ay</del>	<del>Ay</del>	<del>Ay</del>	<del>Ay</del>	<del>Ay</del>
37.	17UPIA0494	Vaishini	Vaishini	Vaishini	Vaishini	Vaishini
38.	17UPIA0495	<del>Pur</del>	<del>Pur</del>	<del>Pur</del>	<del>Pur</del>	<del>Pur</del>
39.	17UPIA0496	<del>Ay</del>	<del>Ay</del>	<del>Ay</del>	<del>Ay</del>	<del>Ay</del>
40.	17UPIA0497	Sai priya	Sai priya	Sai priya	Sai priya	Sai priya
41.	17UPIA0498	<del>Sesh</del>	<del>Sesh</del>	<del>Sesh</del>	<del>Sesh</del>	<del>Sesh</del>
42.	17UPIA0499	Chandu	Chandu	Chandu	Chandu	Chandu
43.	17UPIA04A0	Prathysa	Prathysa	Prathysa	Prathysa	Prathysa
44.	17UPIA04A1	Vyshanu	Vyshanu	Vyshanu	Vyshanu	Vyshanu
45.	18UP5A0401	<del>Shub</del>	<del>Shub</del>	<del>Shub</del>	<del>Shub</del>	<del>Shub</del>
46.	18UP5A0402	<del>Suvar</del>	<del>Suvar</del>	<del>Suvar</del>	<del>Suvar</del>	<del>Suvar</del>
47.	18UP5A0403	Madhavi	Madhavi	Madhavi	Madhavi	Madhavi

  
COORDINATOR

  
HOD

Head of the Department  
Electronics and Communication Engineering  
Vignans Institute of Management & Technology For Women  
Kandapur (V), Ghatakasa (M), Madhavu-Malkajgiri (DL)-501301



  
PRINCIPAL

Vignans Institute of Management & Technology For Women  
Kandapur(V), Ghatakasa(M), Madhavu-Malkajgiri(DL) 501301  
Telangana State



# VIGNAN'S INSTITUTE OF MANAGEMENT AND TECHNOLOGY FOR WOMEN

Sponsored by Law Educational Society, Approved by AICTE, New Delhi & Affiliated to JNTUH, Hyderabad.  
Kondapur (V), Ghatkesar (M), Medchal - Malkajgiri (D) - 501 301 TS INDIA  
Phone: +08615 2000607/08 Email: info@vmtw.in

## DEPARTMENT OF ELECTRONICS AND COMMUNICATION ENGINEERING

ADD ON COURSE NAME: MATLAB for beginners

Academic Year: 2018-19

Date: 18-08-2018

B.Tech II-I SEM

DAY WISE ATTENDANCE SHEET

SECTION: ECE-A

S.No	Roll number	18-08-18	20-08-18	21-08-18	22-08-18	23-08-18
1.	17UP1A0401	Best	Best	Best	Best	Best
2.	17UP1A0402	Vigneshwari	Vigneshwari	Vigneshwari	Vigneshwari	Vigneshwari
3.	17UP1A0403	Best	Best	Best	Best	Best
4.	17UP1A0404	Put	Put	Put	Put	Put
5.	17UP1A0405	Yashu	Yashu	Yashu	Yashu	Yashu
6.	17UP1A0406	Best	Best	Best	Best	Best
7.	17UP1A0407	Oni	Oni	Oni	Oni	Oni
8.	17UP1A0408	Mouni	Mouni	Mouni	Mouni	Mouni
9.	17UP1A0409	Best	Best	Best	Best	Best
10.	17UP1A0411	Best	Best	Best	Best	Best
11.	17UP1A0412	DIVYA	DIVYA	DIVYA	DIVYA	DIVYA
12.	17UP1A0413	Archana	Archana	Archana	Archana	Archana
13.	17UP1A0414	Vaishu	Vaishu	Vaishu	Vaishu	Vaishu
14.	17UP1A0415	Sweetha	Sweetha	Sweetha	Sweetha	Sweetha
15.	17UP1A0416	At	At	At	At	At
16.	17UP1A0417	Akanksha	Akanksha	Akanksha	Akanksha	Akanksha
17.	17UP1A0418	Haripriya	Haripriya	Haripriya	Haripriya	Haripriya
18.	17UP1A0419	Sowmya	Sowmya	Sowmya	Sowmya	Sowmya
19.	17UP1A0420	Best	Best	Best	Best	Best
20.	17UP1A0421	Jahnavi	Jahnavi	Jahnavi	Jahnavi	Jahnavi
21.	17UP1A0422	Et	Et	Et	Et	Et
22.	17UP1A0423	Sree	Sree	Sree	Sree	Sree
23.	17UP1A0424	Pr	Pr	Pr	Pr	Pr
24.	17UP1A0426	Manisha	Manisha	Manisha	Manisha	Manisha
25.	17UP1A0427	Best	Best	Best	Best	Best
26.	17UP1A0428	Sriveni	Sriveni	Sriveni	Sriveni	Sriveni
27.	17UP1A0429	Navya	Navya	Navya	Navya	Navya
28.	17UP1A0430	Nandhu	Nandhu	Nandhu	Nandhu	Nandhu
29.	17UP1A0431	Put	Put	Put	Put	Put
30.	17UP1A0432	Ramys	Ramys	Ramys	Ramys	Ramys
31.	17UP1A0433	Best	Best	Best	Best	Best
32.	17UP1A0434	Saxayu	Saxayu	Saxayu	Saxayu	Saxayu
33.	17UP1A0435	Put	Put	Put	Put	Put
34.	17UP1A0436	Manu	Manu	Manu	Manu	Manu



VIGNAN'S  
Vignans Institute of Management & Technology For Women  
Kondapur(V), Ghatkesar(M), Medchal - Malkajgiri(D)  
Telangana, India

35.	17UP1A0437	bhargavi	bhargavi	bhargavi	bhargavi	bhargavi
36.	17UP1A0438	Preethi	Preethi	Preethi	Preethi	Preethi
37.	17UP1A0439	Saavyasi	Saavyasi	Saavyasi	Saavyasi	Saavyasi
38.	17UP1A0442	keerthana	keerthana	keerthana	keerthana	keerthana
39.	17UP1A0443	Vasanthi	Vasanthi	Vasanthi	Vasanthi	Vasanthi
40.	17UP1A0444	Pranava	Pranava	Pranava	Pranava	Pranava
41.	17UP1A0445	Pranava	Pranava	Pranava	Pranava	Pranava
42.	17UP1A0446	Teja	Teja	Teja	Teja	Teja
43.	17UP1A0447	Teja	Teja	Teja	Teja	Teja
44.	17UP1A0448	Soumya	Soumya	Soumya	Soumya	Soumya
45.	17UP1A0449	Soumya	Soumya	Soumya	Soumya	Soumya
46.	17UP1A0450	Shivani	Shivani	Shivani	Shivani	Shivani
47.	17UP1A0451	Shivani	Shivani	Shivani	Shivani	Shivani
48.	17UP1A0452	Ranjit	Ranjit	Ranjit	Ranjit	Ranjit

*[Handwritten Signature]*

COORDINATOR

*[Handwritten Signature]*

HOD

Head of the Department  
 Electronics and Communication Engineering  
 Vignn's Institute of Management and Technology for Women  
 Kondapur (V), Ghatkesar (M), R.R. Dist-501 301



*[Handwritten Signature]*  
 PRINCIPAL

Vignn's Institute of Management & Technology for Women  
 Kondapur(V), Ghatkesar(M), Medchal-Malkajgiri(Dist)-  
 Telangana State





# VIGNAN'S INSTITUTE OF MANAGEMENT AND TECHNOLOGY FOR WOMEN

Sponsored by Lavu Educational Society, Approved by AICTE, New Delhi & Affiliated to JNTUH, Hyderabad.  
Kondapur (V), Ghatkesar (M), Medchal - Malkajgiri (D) - 501 301 TS INDIA  
Phone: +98615 200006/07/08 Email: info@vmbw.in

## DEPARTMENT OF ELECTRONICS AND COMMUNICATION ENGINEERING

ADD ON COURSE NAME: MATLAB for beginners

Academic Year: 2018-19

Date: 18-08-2018

B.Tech II-I SEM

DAY WISE ATTENDANCE SHEET

SECTION: ECE-B

S.No	Roll number	18-08-18	20-08-18	21-08-18	22-08-18	23-08-18
1.	17UP1A0454	Vaisha	Vaisha	Vaisha	Vaisha	Vaisha
2.	17UP1A0455	Nat	Nat	Nat	Nat	Nat
3.	17UP1A0456	Sany	Sany	Sany	Sany	Sany
4.	17UP1A0457	Shi	Shi	Shi	Shi	Shi
5.	17UP1A0458	chand	chand	chand	chand	chand
6.	17UP1A0459	Pr	Pr	Pr	Pr	Pr
7.	17UP1A0460	Pr	Pr	Pr	Pr	Pr
8.	17UP1A0461	Hit	Hit	Hit	Hit	Hit
9.	17UP1A0463	Pranitha	Pranitha	Pranitha	Pranitha	Pranitha
10.	17UP1A0464	Pranitha	Pranitha	Pranitha	Pranitha	Pranitha
11.	17UP1A0465	venkt	venkt	venkt	venkt	venkt
12.	17UP1A0466	St	St	St	St	St
13.	17UP1A0467	St	St	St	St	St
14.	17UP1A0468	sant	sant	sant	sant	sant
15.	17UP1A0469	flor	flor	flor	flor	flor
16.	17UP1A0470	Sul	Sul	Sul	Sul	Sul
17.	17UP1A0471	Pravallika	Pravallika	Pravallika	Pravallika	Pravallika
18.	17UP1A0472	Poul	Poul	Poul	Poul	Poul
19.	17UP1A0473	Ravi	Ravi	Ravi	Ravi	Ravi
20.	17UP1A0474	maurica	maurica	maurica	maurica	maurica
21.	17UP1A0475	Mouni	Mouni	Mouni	Mouni	Mouni
22.	17UP1A0477	ant	ant	ant	ant	ant
23.	17UP1A0478	Sit	Sit	Sit	Sit	Sit
24.	17UP1A0479	Hima	Hima	Hima	Hima	Hima
25.	17UP1A0480	Shr	Shr	Shr	Shr	Shr
26.	17UP1A0481	Swathi	Swathi	Swathi	Swathi	Swathi
27.	17UP1A0482	sanvi	sanvi	sanvi	sanvi	sanvi
28.	17UP1A0483	Pr	Pr	Pr	Pr	Pr
29.	17UP1A0484	sahika	sahika	sahika	sahika	sahika
30.	17UP1A0485	Pr	Pr	Pr	Pr	Pr
31.	17UP1A0487	vait	vait	vait	vait	vait
32.	17UP1A0488	Pr	Pr	Pr	Pr	Pr



  
PRINCIPAL  
Vignani's Institute of Management & Technology For Women  
Kondapur(V), Ghatkesar(M), Medchal-Malkajgiri(D)  
Telangana State

33.	17UP1A0489	Vaishha	Vaishha	Vaishha	Vaishha	Vaishha
34.	17UP1A0490	Pujitha	Pujitha	Pujitha	Pujitha	Pujitha
35.	17UP1A0491	Ku	Ku	Ku	Ku	Ku
36.	17UP1A0493	A	A	A	A	A
37.	17UP1A0494	Vaishini	Vaishini	Vaishini	Vaishini	Vaishini
38.	17UP1A0495	Seif	Seif	Seif	Seif	Seif
39.	17UP1A0496	At	At	At	At	At
40.	17UP1A0497	sai priya	sai priya	sai priya	sai priya	sai priya
41.	17UP1A0498	Sesh	Sesh	Sesh	Sesh	Sesh
42.	17UP1A0499	Chandu	Chandu	Chandu	Chandu	Chandu
43.	17UP1A04A0	Prathiyusha	Prathiyusha	Prathiyusha	Prathiyusha	Prathiyusha
44.	17UP1A04A1	Vyshnes	Vyshnes	Vyshnes	Vyshnes	Vyshnes
45.	18UP5A0401	Subh	Subh	Subh	Subh	Subh
46.	18UP5A0402	SUBHI	SUBHI	SUBHI	SUBHI	SUBHI
47.	18UP5A0403	Madhavi	Madhavi	Madhavi	Madhavi	Madhavi

COORDINATOR

ECE,HOD

Head of the Department  
 Electronics and Communication Engineering  
 Vignans Institute of Management and Technology for Women  
 Kondapur (V), Ghatkesar (M), R.R. Dist-501301



PRINCIPAL

Vignans Institute of Management & Technology for Women  
 Kondapur(V), Ghatkesar(M), Malkajgiri(D)-501301  
 Telangana State



# VIGNAN'S INSTITUTE OF MANAGEMENT AND TECHNOLOGY FOR WOMEN

Sponsored by Law Educational Society, Approved by AICTE, New Delhi & Affiliated to JNTUH, Hyderabad.  
Kondapur (V), Ghatkesar (M), Medchal - Malkajgiri (D) - 501 301 TS INDIA  
Phone: +08615 200006/07/08 Email: info@vmtw.in

## DEPARTMENT OF ELECTRONICS AND COMMUNICATION ENGINEERING

ADD ON COURSE NAME: MATLAB for beginners

Academic Year: 2018-19

Date: 24-08-2018

B.Tech II-I SEM

DAY WISE ATTENDANCE SHEET

SECTION: ECE-A

S.No	Roll number	24-08-18	25-08-18	27-08-18	28-08-18	29-08-18
1.	17UP1A0401	Prat	Prat	Prat	Prat	Prat
2.	17UP1A0402	Vigneshwari	Vigneshwari	Vigneshwari	Vigneshwari	Vigneshwari
3.	17UP1A0403	Prat	Prat	Prat	Prat	Prat
4.	17UP1A0404	Prat	Prat	Prat	Prat	Prat
5.	17UP1A0405	Yashu	Yashu	Yashu	Yashu	Yashu
6.	17UP1A0406	Prat	Prat	Prat	Prat	Prat
7.	17UP1A0407	Prat	Prat	Prat	Prat	Prat
8.	17UP1A0408	Mouni	Mouni	Mouni	Mouni	Mouni
9.	17UP1A0409	Prat	Prat	Prat	Prat	Prat
10.	17UP1A0411	Prat	Prat	Prat	Prat	Prat
11.	17UP1A0412	DIVYA	DIVYA	DIVYA	DIVYA	DIVYA
12.	17UP1A0413	Archana	Archana	Archana	Archana	Archana
13.	17UP1A0414	Vaishu	Vaishu	Vaishu	Vaishu	Vaishu
14.	17UP1A0415	Smriti	Smriti	Smriti	Smriti	Smriti
15.	17UP1A0416	Prat	Prat	Prat	Prat	Prat
16.	17UP1A0417	Akanksha	Akanksha	Akanksha	Akanksha	Akanksha
17.	17UP1A0418	Haripriya	Haripriya	Haripriya	Haripriya	Haripriya
18.	17UP1A0419	Sowmya	Sowmya	Sowmya	Sowmya	Sowmya
19.	17UP1A0420	Prat	Prat	Prat	Prat	Prat
20.	17UP1A0421	Jahnvi	Jahnvi	Jahnvi	Jahnvi	Jahnvi
21.	17UP1A0422	Prat	Prat	Prat	Prat	Prat
22.	17UP1A0423	Sree	Sree	Sree	Sree	Sree
23.	17UP1A0424	Prat	Prat	Prat	Prat	Prat
24.	17UP1A0426	Manisha	Manisha	Manisha	Manisha	Manisha
25.	17UP1A0427	Prat	Prat	Prat	Prat	Prat
26.	17UP1A0428	Sriveni	Sriveni	Sriveni	Sriveni	Sriveni
27.	17UP1A0429	Vaishu	Vaishu	Vaishu	Vaishu	Vaishu
28.	17UP1A0430	Nandhu	Nandhu	Nandhu	Nandhu	Nandhu
29.	17UP1A0431	Prat	Prat	Prat	Prat	Prat
30.	17UP1A0432	Ramya	Ramya	Ramya	Ramya	Ramya
31.	17UP1A0433	Prat	Prat	Prat	Prat	Prat
32.	17UP1A0434	Sowmya	Sowmya	Sowmya	Sowmya	Sowmya
33.	17UP1A0435	Prat	Prat	Prat	Prat	Prat



*Vignans*  
PRINCIPAL

Vignans Institute of Management & Technology For Women  
Kondapur(V), Ghatkesar(M), Medchal - Malkajgiri (D) - 501 301  
Telangana State

34.	17UPIA0436	Manu	Manu	Manu	Manu	Manu
35.	17UPIA0437	bhargavi	bhargavi	bhargavi	bhargavi	bhargavi
36.	17UPIA0438	Preethi	Preethi	Preethi	Preethi	Preethi
37.	17UPIA0439	Sravani	Sravani	Sravani	Sravani	Sravani
38.	17UPIA0442	keerthana	keerthana	keerthana	keerthana	keerthana
39.	17UPIA0443	varanthy	varanthy	varanthy	varanthy	varanthy
40.	17UPIA0444	Shruti	Shruti	Shruti	Shruti	Shruti
41.	17UPIA0445	Panava	Panava	Panava	Panava	Panava
42.	17UPIA0446	Shruti	Shruti	Shruti	Shruti	Shruti
43.	17UPIA0447	Liza	Liza	Liza	Liza	Liza
44.	17UPIA0448	Shruti	Shruti	Shruti	Shruti	Shruti
45.	17UPIA0449	Sourya	Sourya	Sourya	Sourya	Sourya
46.	17UPIA0450	Shivani	Shivani	Shivani	Shivani	Shivani
47.	17UPIA0451	Shrey	Shrey	Shrey	Shrey	Shrey
48.	17UPIA0452	Ravi	Ravi	Ravi	Ravi	Ravi

*[Signature]*

COORDINATOR

*[Signature]*

HOD

Head of the Department  
Electronics and Communication Engineering  
Vignans Institute of Management and Technology for Women  
Kondapur (V), Ghatkesar (M), R.R. Dist-501 2



*[Signature]*  
PRINCIPAL

Vignans Institute of Management & Technology for Women  
Kondapur(V), Ghatkesar(M), Medchal-Malkajgiri(Dt) -  
Telangana State



# VIGNAN'S INSTITUTE OF MANAGEMENT AND TECHNOLOGY FOR WOMEN

Sponsored by Law Educational Society, Approved by AICTE, New Delhi & Affiliated to INTUW, Hyderabad.  
Kondapur (V), Ghatkesar (M), Medchal - Malkajgiri (D) - 501 301 TS INDIA  
Phone: +08615 200006/07/08 Email: info@vmtwr.in

## DEPARTMENT OF ELECTRONICS AND COMMUNICATION ENGINEERING

ADD ON COURSE NAME: MATLAB for beginners

Academic Year: 2018-19

Date: 24-08-2018

B.Tech II-I SEM

DAY WISE ATTENDANCE SHEET

SECTION: ECE-B

S.No	Roll number	24-08-18	25-08-18	27-08-18	28-08-18	29-07-18
1.	17UP1A0454	Vaasha	Vaasha	Vaasha	Vaasha	Vaasha
2.	17UP1A0455	<del>Not</del>	<del>Not</del>	<del>Not</del>	<del>Not</del>	<del>Not</del>
3.	17UP1A0456	<del>Sant</del>	<del>Sant</del>	<del>Sant</del>	<del>Sant</del>	<del>Sant</del>
4.	17UP1A0457	<del>Shi</del>	<del>Shi</del>	<del>Shi</del>	<del>Shi</del>	<del>Shi</del>
5.	17UP1A0458	chand	chand	chand	chand	chand
6.	17UP1A0459	<del>Shi</del>	<del>Shi</del>	<del>Shi</del>	<del>Shi</del>	<del>Shi</del>
7.	17UP1A0460	<del>Shi</del>	<del>Shi</del>	<del>Shi</del>	<del>Shi</del>	<del>Shi</del>
8.	17UP1A0461	<del>Shi</del>	<del>Shi</del>	<del>Shi</del>	<del>Shi</del>	<del>Shi</del>
9.	17UP1A0463	Pranitha	Pranitha	Pranitha	Pranitha	Pranitha
10.	17UP1A0464	Pranitha	Pranitha	Pranitha	Pranitha	Pranitha
11.	17UP1A0465	venket	venket	venket	venket	venket
12.	17UP1A0466	<del>Shi</del>	<del>Shi</del>	<del>Shi</del>	<del>Shi</del>	<del>Shi</del>
13.	17UP1A0467	<del>Shi</del>	<del>Shi</del>	<del>Shi</del>	<del>Shi</del>	<del>Shi</del>
14.	17UP1A0468	<del>Sant</del>	<del>Sant</del>	<del>Sant</del>	<del>Sant</del>	<del>Sant</del>
15.	17UP1A0469	<del>Shi</del>	<del>Shi</del>	<del>Shi</del>	<del>Shi</del>	<del>Shi</del>
16.	17UP1A0470	<del>Sant</del>	<del>Sant</del>	<del>Sant</del>	<del>Sant</del>	<del>Sant</del>
17.	17UP1A0471	Pravallika	Pravallika	Pravallika	Pravallika	Pravallika
18.	17UP1A0472	<del>Shi</del>	<del>Shi</del>	<del>Shi</del>	<del>Shi</del>	<del>Shi</del>
19.	17UP1A0473	Ravi	Ravi	Ravi	Ravi	Ravi
20.	17UP1A0474	<del>Pravallika</del>	<del>Pravallika</del>	<del>Pravallika</del>	<del>Pravallika</del>	<del>Pravallika</del>
21.	17UP1A0475	Mouni	Mouni	Mouni	Mouni	Mouni
22.	17UP1A0477	<del>Shi</del>	<del>Shi</del>	<del>Shi</del>	<del>Shi</del>	<del>Shi</del>
23.	17UP1A0478	<del>Shi</del>	<del>Shi</del>	<del>Shi</del>	<del>Shi</del>	<del>Shi</del>
24.	17UP1A0479	Hima	Hima	Hima	Hima	Hima
25.	17UP1A0480	<del>Shi</del>	<del>Shi</del>	<del>Shi</del>	<del>Shi</del>	<del>Shi</del>
26.	17UP1A0481	Swathi	Swathi	Swathi	Swathi	Swathi
27.	17UP1A0482	<del>Kavya</del>	<del>Kavya</del>	<del>Kavya</del>	<del>Kavya</del>	<del>Kavya</del>
28.	17UP1A0483	<del>Shi</del>	<del>Shi</del>	<del>Shi</del>	<del>Shi</del>	<del>Shi</del>
29.	17UP1A0484	Sahika	Sahika	Sahika	Sahika	Sahika
30.	17UP1A0485	<del>Shi</del>	<del>Shi</del>	<del>Shi</del>	<del>Shi</del>	<del>Shi</del>
31.	17UP1A0487	<del>Shi</del>	<del>Shi</del>	<del>Shi</del>	<del>Shi</del>	<del>Shi</del>
32.	17UP1A0488	<del>Shi</del>	<del>Shi</del>	<del>Shi</del>	<del>Shi</del>	<del>Shi</del>
33.	17UP1A0489	Vaasha	Vaasha	Vaasha	Vaasha	Vaasha



*Vignans*  
PRINCIPAL

Vignans Institute of Management & Technology For Women  
Kondapur (V), Ghatkesar (M), Medchal - Malkajgiri (D)  
Telangana - India

34.	17UP1A0490	Pujitha	Pujitha	Pujitha	Pujitha	Pujitha
35.	17UP1A0491	Pu	Pu	Pu	Pu	Pu
36.	17UP1A0493	As	As	As	As	As
37.	17UP1A0494	Vasshini	Vasshini	Vasshini	Vasshini	Vasshini
38.	17UP1A0495	Res	Res	Res	Res	Res
39.	17UP1A0496	Rut	Rut	Rut	Rut	Rut
40.	17UP1A0497	sai priya	sai priya	sai priya	sai priya	sai priya
41.	17UP1A0498	Sesha	Sesha	Sesha	Sesha	Sesha
42.	17UP1A0499	Chandu	Chandu	Chandu	Chandy	Chandu
43.	17UP1A04A0	Prathiyusha	Prathiyusha	Prathiyusha	Prathiyusha	Prathiyusha
44.	17UP1A04A1	Vysames	Vysames	Vysames	Vysames	Vysames
45.	18UP5A0401	Sub	Sub	Sub	Sub	Sub
46.	18UP5A0402	SUBHI	SUBHI	SUBHI	SUBHI	SUBHI
47.	18UP5A0403	Madhavi	Madhavi	Madhavi	Madhavi	Madhavi

  
COORDINATOR

  
HOD

Head of the Department  
Electronics and Communication Engineering  
Vignana's Institute of Management and Technology for Women  
Kondapur (V), Ghatkesar (M), R.R. Dist-501301



  
PRINCIPAL  
Vignana's Institute of Management & Technology for Women  
Kondapur(V), Ghatkesar(M), Medchal-Malkajgiri(OT)-501301  
Telangana State



# VIGNAN'S INSTITUTE OF MANAGEMENT AND TECHNOLOGY FOR WOMEN

Sponsored by Lavu Educational Society, Approved by AICTE, New Delhi & Affiliated to JNTU, Hyderabad.  
Kondapur (V), Ghatkesar (M), Medchal - Malkajgiri (D) - 501 301 TS INDIA  
Phone: +08815 200006/07/08 Email: info@vmtw.in

## DEPARTMENT OF ELECTRONICS AND COMMUNICATION ENGINEERING

ADD ON COURSE NAME: MATLAB for beginners

Academic Year: 2018-19

Date: 30-08-2018

B.Tech II-I SEM

DAY WISE ATTENDANCE SHEET

SECTION: ECE-A

S.No	Roll number	30-08-18	31-08-18
1.	17UP1A0401	[Signature]	[Signature]
2.	17UP1A0402	Vigneshwari	Vigneshwari
3.	17UP1A0403	[Signature]	[Signature]
4.	17UP1A0404	[Signature]	[Signature]
5.	17UP1A0405	Yashu..	Yashu..
6.	17UP1A0406	[Signature]	[Signature]
7.	17UP1A0407	[Signature]	[Signature]
8.	17UP1A0408	Mouni	Mouni
9.	17UP1A0409	[Signature]	[Signature]
10.	17UP1A0411	[Signature]	[Signature]
11.	17UP1A0412	DIVYA	DIVYA
12.	17UP1A0413	Archana	Archana
13.	17UP1A0414	Vaishu	Vaishu
14.	17UP1A0415	Swotha	Swotha
15.	17UP1A0416	[Signature]	[Signature]
16.	17UP1A0417	Akanksha	Akanksha
17.	17UP1A0418	Hari priya	Hari Priya
18.	17UP1A0419	Sowmya	Sowmya
19.	17UP1A0420	[Signature]	[Signature]
20.	17UP1A0421	Jahnavi	Jahnavi
21.	17UP1A0422	[Signature]	[Signature]
22.	17UP1A0423	Sree	Sree
23.	17UP1A0424	[Signature]	[Signature]
24.	17UP1A0426	Manisha	Manisha
25.	17UP1A0427	[Signature]	[Signature]
26.	17UP1A0428	Sriveni	Sriveni
27.	17UP1A0429	Navya	Navya
28.	17UP1A0430	Nandhu	Nandhu
29.	17UP1A0431	[Signature]	[Signature]
30.	17UP1A0432	Ramys	Ramys
31.	17UP1A0433	[Signature]	[Signature]
32.	17UP1A0434	Sarayu	Sarayu
33.	17UP1A0435	[Signature]	[Signature]



*[Signature]*  
PRINCIPAL

Vignans Institute of Management & Technology For Women  
Kondapur(V), Ghatkesar(M), Medchal-Malkajgiri(D), TS  
Telangana State

34.	17UP1A0436	Manu	Manu
35.	17UP1A0437	Bhargavi	Bhargavi
36.	17UP1A0438	Preethe	Preethe
37.	17UP1A0439	Sravvathi	Sravvathi
38.	17UP1A0442	keesthana	keesthana
39.	17UP1A0443	Vasanthi	Vasanthi
40.	17UP1A0444	[Signature]	[Signature]
41.	17UP1A0445	Panava	Panava
42.	17UP1A0446	[Signature]	[Signature]
43.	17UP1A0447	Teja	Teja
44.	17UP1A0448	[Signature]	[Signature]
45.	17UP1A0449	Sarunya	Sarunya
46.	17UP1A0450	Kirvani	Kirvani
47.	17UP1A0451	Shri	Shri
48.	17UP1A0452	Ranj	Ranj

  
COORDINATOR

  
HOD

Head of the Department  
Electronics and Communication Engineering  
Tigm's Institute of Management and Technology For Women  
Kondapur (V), Ghatkesar (M) R.R. Dist-501 301



  
PRINCIPAL  
Tigm's Institute of Management & Technology For Women  
Kondapur (V), Ghatkesar (M), Medchal-Mahabubnagar (M) Dist-501 301  
Telangana State





# VIGNAN'S INSTITUTE OF MANAGEMENT AND TECHNOLOGY FOR WOMEN

Sponsored by Lavu Educational Society, Approved by AICTE, New Delhi & Affiliated to JNTUH, Hyderabad.  
Kondapur (V), Ghatkesar (M), Medchal - Malkajgiri (D) - 501 301 TS INDIA  
Phone: +08815 200006/07/08 Email: info@vnmw.in

## DEPARTMENT OF ELECTRONICS AND COMMUNICATION ENGINEERING

ADD ON COURSE NAME: MATLAB for beginners

Academic Year: 2018-19

Date: 30-08-2018

B.Tech II-I SEM

DAY WISE ATTENDANCE SHEET

SECTION: ECE-A

S.No	Roll number	30-08-18	31-08-18
1.	17UP1A0454	Vaisha	Vaisha
2.	17UP1A0455	Naf	Naf
3.	17UP1A0456	Sany	Sany
4.	17UP1A0457	Shi	Shi
5.	17UP1A0458	chand	chand
6.	17UP1A0459	At	At
7.	17UP1A0460	At	At
8.	17UP1A0461	Hij	Hij
9.	17UP1A0463	Pranitha	Pranitha
10.	17UP1A0464	Pranitha	Pranitha
11.	17UP1A0465	Venkat	Venkat
12.	17UP1A0466	Et	Et
13.	17UP1A0467	Et	Et
14.	17UP1A0468	Sany	Sany
15.	17UP1A0469	FDJ	FDJ
16.	17UP1A0470	Sany	Sany
17.	17UP1A0471	Pravalika	Pravalika
18.	17UP1A0472	Yut	Yut
19.	17UP1A0473	Koush	Koush
20.	17UP1A0474	Manjira	Manjira
21.	17UP1A0475	Mouki	Mouki
22.	17UP1A0477	Ant	Ant
23.	17UP1A0478	sit	sit
24.	17UP1A0479	Hima	Hima
25.	17UP1A0480	sh	sh
26.	17UP1A0481	swathi	swathi
27.	17UP1A0482	swathi	swathi
28.	17UP1A0483	tan	tan
29.	17UP1A0484	saharika	saharika
30.	17UP1A0485	My	My
31.	17UP1A0487	vast	vast
32.	17UP1A0488	Pur	Pur
33.	17UP1A0489	Varsha	Varsha



*(Signature)*

PRINCIPAL

Vignans Institute of Management & Technology For Women  
Kondapur(V), Ghatkesar(M), Medchal - Malkajgiri(D)-501  
Telangana State

34.	17UP1A0490	ajitha	ajitha
35.	17UP1A0491	Ku	Ku
36.	17UP1A0493	Aj	Aj
37.	17UP1A0494	Varshini	Varshini
38.	17UP1A0495	Sest	Sest
39.	17UP1A0496	Aj	Aj
40.	17UP1A0497	sai priya	sai priya
41.	17UP1A0498	Sesh	Sesh
42.	17UP1A0499	Chandu	Chandu
43.	17UP1A04A0	Prathiyusa	Prathiyusa
44.	17UP1A04A1	Vishnes	Vishnes
45.	18UP5A0401	Subh	Subh
46.	18UP5A0402	SUBH	SUBH
47.	18UP5A0403	mm	mm

  
COORDINATOR

  
HOD

Head of the Department  
Electronics and Communication Engineering  
Vignana Institute of Management and Technology For Women  
Kondapur (V), Ghatkesar (M), R.R. Dist-501 301



  
PRINCIPAL  
Vignana Institute of Management & Technology For Women  
Kondapur (V), Ghatkesar (M), Medchal-Malkajgiri (DT)-501301  
Telangana State



DEPARTMENT OF ELECTRONICS AND COMMUNICATION ENGINEERING

Date: 01-09-2018.

PROGRAM REPORT

Name of the Add on Course: MATLAB for beginners

Day/Duration: 37 Hours

Time: 4:00pm to 5:00pm

Resource Person: K. Jagadeeswar Reddy, Technical Manager, Elegant Embedded Solutions, Hyd.

Name of the Coordinator: Mr. E. Nagaraju, Assistant Professor, VMTW. Hyderabad.

Number of the Participants: 95

Topics covered: The following topics covered in this program

- Basic syntax
- Looping,
- 2D & 3D Plotting.
- Design simple algorithms to solve problems.

Course Outcomes:

COs	At the end of the course, students will have the ability to:	PO s Mapped	Strength of mapping
CO1	Understand the main features of the MATLAB development	PO3,PO5	2
CO2	Understand the fundamentals of sampling including the implications of sampling theorem.	PO1,PO4	3
CO3	Analyze the signals with different transform technique	PO5,PO3	4
CO4	Apply the concepts of convolution and correlation for	PO1,PO4	4

Assessment Procedure: The assessment of the Add on course is conducted in Multiple Choice Questions through offline Mode.

Handwritten signature of Coordinator  
Coordinator



Handwritten signature of Principal  
PRINCIPAL  
Vignans Institute of Management & Technology For Women  
Kondapur(V), Ghatkesar(M), Medchal-Malkajgiri(DT)-501301  
Telangana State

Handwritten signature of ECE, HOD  
ECE, HOD

Head of the Department  
Electronics and Communication Engineering  
Vignans Institute of Management & Technology For Women  
Kondapur (V), Ghatkesar (M), Medchal-Malkajgiri (Dt.)-501301



# VIGNAN'S INSTITUTE OF MANAGEMENT AND TECHNOLOGY FOR WOMEN

(Sponsored by Lavu Educational Society)

Approved by AICTE, New Delhi & Affiliated to JNTUH, Hyderabad.

Kondapur Village, Ghatkesar Mandal, Medchal - Malkajgiri Dist - 501 301 TS, INDIA



ELEGANT EMBEDDED SOLUTIONS PVT. LTD.

## Certificate of Course Completion

This certificate is presented to

**YAKITI SHIRISHA**

for her completion of an Add-on course on "MATLAB FOR BEGINNERS"

held from 20<sup>TH</sup> JUL to 30<sup>TH</sup> AUG, 2018, Organized by the

Department of Electronics and Communication Engineering.

In association with Elegant Embedded Solutions Pvt. Ltd. Hyderabad.

Co-ordinator



HoD, ECE

Head of the Department  
Electronics and Communication Engineering  
Vignans Institute of Management and Technology for Women  
Kondapur (V), Ghatkesar (M), R.R. Dist 501 301

PRINCIPAL

Vignans Institute of Management & Technology for Women  
Kondapur(V), Ghatkesar(M), Medchal-Malkajgiri(DL)-501301  
Telangana State

Principal  
PRINCIPAL

Vignans Institute of Management & Technology for Women  
Kondapur(V), Ghatkesar(M), Medchal-Malkajgiri(DL)-501301  
Telangana State



**DEPARTMENT OF ELECTRONICS AND COMMUNICATION ENGINEERING**

VMTW/ECE/WS/CIR/2021-22/2/1

Date: 25-04-2022

**CIRCULAR**

This is to inform all the III ECE Students that there will be a Workshop on entitled "Application Design using IOT and Cloud services" in Association with Elegant Embedded Solutions PVT LTD, HYD by Mr. K. Jagdeswar Reddy from 29-04-2022 to 30-04-2022 at B-Block Seminar Hall. All students are invited to take part in this Workshop. The participating students will be honored with certificates of participation.

During the Workshop you will be encouraged to interact with the speaker and the other participants through the case study discussions.

  
HOD

Copy to:

The Principal, for kind information

IQAC

Dept. File

Circular to III ECE Class Rooms





PRINCIPAL

Vignans Institute of Management & Technology For Wo.  
Kondapur(V), Ghatkesar(M), Medchal-Malkajgiri(D)-501301  
Telangana State

Request to conduct a workshop in our college

Dept. of ECE VMTW <ece@vmtw.in>

To: <k.jagadeshwar@gmail.com>

Fri April, 22<sup>nd</sup>, 2022 at 11:54 AM

Respected sir,

I am Mr.P.Harishna, HOD, Dept of ECE, Vignana's Institute Of Management And Technology For Women, Ghatkesar, Hyderabad, Telangana. We are planning to conduct a two day workshop on "Application Design Using IOT and Cloud Services" on 29<sup>th</sup> and 30<sup>th</sup> April 2022 to enhance the knowledge of the students. I request to send approval for conducting workshop

Thanking you

Thanks Regards  
P. Harikrishna  
Assoc. Prof & HOD,  
Dept. of ECE, VMTW  
Contact: 7093246048



  
**PRINCIPAL**  
Vignana's Institute of Management & Technology For Women  
Ghatkesar(M), Medchal-Metrajim, Dist-501301  
Telangana State



ELEGANT EMBEDDED SOLUTIONS PVT LTD <info@elegantembedded.com>

## Regarding work shop approval

ELEGANT EMBEDDED SOLUTIONS PVT LTD <info@elegantembedded.com>

To: Dept. of ECE VMTW <ece@vmtw.in>

18, April, 2022 at 11:02 AM

Sir/Madam,

Sub: approved for organizing workshop  
Hence further enhancement of students knowledge we have approved the organization to conduct a two day workshop on  
"Application Design Using IOT and Cloud Services".

With Regards,  
Elegant Embedded Solutions Pvt Ltd,  
9985784340, 9396671541,  
[www.elegantembedded.com](http://www.elegantembedded.com)



  
PRINCIPAL  
Vignani's Institute of Management & Technology For Women  
Kondapur(V), Ghatkesar(M), Medchal-Malkajgiri(D)-501301  
Telangana State

# REGISTRATION FORM

Name: .....

Date of Birth & Age: .....

Gender (M/F): .....

Qualifications: .....

A). Institution: .....

B). Affiliating University: .....

Address for Communication: .....

Phone Nos. ....

Office: .....

Personal: .....

Mail: .....

Resource Person:  
**Mr. K. Jagadeshwar Reddy**  
Elegant Embedded Systems Pvt. Ltd.,  
Hyderabad.

Chief-patrons:  
**Dr. L. Rathaiah,**  
Chairman,  
Vignan Group of Institutions.

**Mr. B. Shravan,**  
Chief Executive Officer,  
Vignan Group of Institutions

Patron:  
**Dr. G. Apparao Naidu,**  
Principal, VMTW

**Mr. P. Harikrishna,**  
Head of the Department, ECE.

Co-ordinator:  
**Mr. J. Sunil Kumar**  
Assitant Professor,  
Dept. of ECE,  
Contact No: +91 83747 17668

Student Co-ordinator:  
**Ms. Pottumuthu Sindhu**  
Contact No: +91 86886 22096

**Ms. Vegeshana Laxmi Vasundhara**  
Contact No: +91 77320 02074

[www.vmtw.in](http://www.vmtw.in)

 **VIGNAN'S**  
**INSTITUTE OF MANAGEMENT AND  
TECHNOLOGY FOR WOMEN**

(Sponsored by Lava Educational Society)  
Approved by AICTE, New Delhi & Affiliated to JNTUH, Hyderabad.  
Kondapur (V), Ghatkesar (M), Medchal - Malkajgiri (D) - 501 301

A TWO DAY WORKSHOP ON  
**"APPLICATION DESIGN  
USING IOT AND  
CLOUD SERVICES"**  
29<sup>TH</sup> & 30<sup>TH</sup> APRIL, 2022

VENUE:  
**'B'-BLOCK SEMINAR HALL, VMTW**

ORGANIZED BY:  
**DEPARTMENT OF ELECTRONICS AND  
COMMUNICATION ENGINEERING**



**LAST DATE FOR REGISTRATION: 27<sup>TH</sup> APRIL, 2022**



*Ad*  
PRINCIPAL



## ABOUT THE INSTITUTION

Vignan's Institute of Management and Technology for Women (VMTW) is the brainchild of Dr. L. Rathalah, Chairman, Vignan Group of Institutions, which was founded in August 2008, with four branches of Engineering.

VMTW is an exemplary institution of higher learning with a mission of pursuing excellence in education and research. The institution, with its diverse and dynamic community of about 2000 students offers a distinctive combination of some of the finest facilities for 7 different graduate, and undergraduate programs, accomplished faculty, world-class facilities with a hostel set on a sprawling area of 22 acres sylvan surroundings of mango groves and greenery.

While students at VMTW immerse themselves in academics, the college has a lot in store for them outside the classroom. Student life includes participation in sports, recreational & co-curricular, and cultural activities. In short, at VMTW students will find an academic and social environment where everyone from faculty members to peers helps shape their future.

VMTW is a home to aesthetically designed buildings with state-of-the-art computer and internet facilities, modern laboratories, workshops, seminar halls, auditoriums, and well-stocked libraries, sports, and games fields.

The Institution boasts of a strong alumni network with alumni events held every year serving as a platform for past students to give back to VMTW and share their experiences with its present fellow students. With so much to offer, it is only natural that students of VMTW get a unique opportunity to carve a niche for themselves in their chosen field of study that enables them to become well-rounded and discerning citizens, fully qualified for their chosen professions in the workplace. Institute also brings out its creativity in students by imparting engineering knowledge imbuing interpersonal skills to promote innovation, research, and entrepreneurship.

## ABOUT THE DEPARTMENT

Department of Electronics and Communication Engineering was initiated since the inception of Vignan's Institute of Management and Technology for Women during 2008 with an initial intake of 90. Its strength was enhanced to 120 during 2010. The Department added Post graduate programme in VLSI during the year 2011 and Embedded Systems during 2014 with an intake of 18 each.

The Department has state-of-art laboratories equipped with advanced and well maintained equipment, continuously updated application software packages, more than adequate computing systems with 2x7.30 MBPS internet facility.

## ABOUT THE COURSE

The Internet of Things (IoT) makes available a large variety of assets (e.g., data, devices, and services) that are used in a number of ways that were once unthinkable. Similarly, foreseeing the future use of IoT assets is difficult if not impossible. The rapidly increasing number of intelligent, cloud-connected things that are embedded in our daily lives raises legitimate concerns about the privacy costs paid for the benefits these technologies provide.

## COURSE OBJECTIVES

- The Internet of Things (IoT) concept has attracted a lot of attention in recent years and it is foreseen as one of the technologies that will leverage the Future Internet. It is seen as a major enabler of novel applications and services that will foster efficiency and will ease everyday life.
- However, current IoT solutions are mainly focusing on the development of centralized solutions that do not promote the democratization of the IoT but rather concentrate the IoT around a set of cloud-based platforms which pretend to be open but limit the capacity of the people to tailor their Personal and Communal IoT.

## EXPECTED OUTCOMES

- At the end of Workshop, participants will be able to
  - IoT Cloud Computing provides many connectivity options, implying large network access. People use a wide range of devices to gain access to cloud computing resources: mobile devices, tablets, and laptops. This is convenient for users but creates the problem of the need for network access points. Developers can use IoT cloud computing on-demand. In other words, it is a web service accessed without special permission or any help. The only requirement is Internet access.
  - Based on the request, users can scale the service according to their needs. Fast and flexible means you can expand storage space, edit software settings, and work with the number of users. Due to this characteristic, it is possible to provide deep computing power and storage.



*(Handwritten signature)*

PRINCIPAL

Vignan's Institute of Management & Technology for Women  
Kondapur (V), Hyderabad, India  
Telangana State



# VIGNAN'S INSTITUTE OF MANAGEMENT AND TECHNOLOGY FOR WOMEN

Sponsored by Lavu Educational Society, Approved by AICTE, New Delhi & Affiliated to JNTUH, Hyderabad.  
Kondapur (V), Ghatkesar (M), Medchal - Malkajgiri (D) - 501 301 Phone: +91 96529 10002/3



## WORKSHOP ON

# APPLICATION DESIGN USING IOT AND CLOUD SERVICES

## 29<sup>TH</sup> & 30<sup>TH</sup> APRIL, 2022

### DEPARTMENT OF ELECTRONICS AND COMMUNICATION ENGINEERING



*Adh*  
PRINCIPAL  
Vignans Institute of Management & Technology For Women  
Kondapur (V), Ghatkesar (M), Medchal - Malkajgiri (D) - 501 301



# VIGNAN'S INSTITUTE OF MANAGEMENT AND TECHNOLOGY FOR WOMEN

(Sponsored by Lavu Educational Society)  
Approved by AICTE, New Delhi & Affiliated to JNTUH, Hyderabad.  
Kondapur (V), Ghatkesar (M), Medchal - Malkajgiri (D) - 501 301



## CERTIFICATE OF PARTICIPATION

This certificate is presented to

.....  
for her participation in a Two Day Workshop on  
"Application Design Using IOT and Cloud Services"  
held from 29-04-2022 to 30-04-2022, Organized by the  
Department of Electronics and Communication Engineering.

Coordinator



*VASH*  
HoD, ECE

PRINCIPAL

Vignan's Institute of Management & Technology  
Kondapur(V), Ghatkesar(M), Medchal-Malkajgiri (D) - 501 301  
Telangana State

Principal



Vignann's Institute Of Management and Technology For Women  
Work shop on "Application design using IOT & CLOUD services"

III B.Tech II sem Students List-2021-22

Branch :ECE-A



S. No	Hall Ticket No	Student Name	Sign of the student- 29/04/22	Sign of the student- 30/04/22
1	19UP1A0401	ARKALA SNEHA REDDY	A. sneha	A. sneha
2	19UP1A0402	BANDI RASAGNA	B. Rasgna	B. Rasgna
3	19UP1A0403	BASWA VIGNATHA	Vignatha	Vignatha
4	19UP1A0404	BELLI PAVANI	Pavani	Pavani
5	19UP1A0405	B V SHIVA KEERTHIKA	B.V S Keerthi	B.V S Keerthi
6	19UP1A0406	DIWAKARLA SAI LAKSHMI SRAVYA	savya	savya
7	19UP1A0407	GAJULA ABHIGNA	abhigna	abhigna
8	19UP1A0408	GADDAM LIKHITHA	Likhitha	Likhitha
9	19UP1A0409	GIRUGUBOTHALA SAI DEEPTHI	Saidheepthi	Saidheepthi
10	19UP1A0410	GOLLA PRIYANKA	Priyanka	Priyanka
11	19UP1A0411	GOURISHETTI SWETHA	Swetha	Swetha
12	19UP1A0412	KOPPELA NISHITHA	Nishitha	Nishitha
13	19UP1A0413	KALAVA CHARITHA	Charitha	Charitha
14	19UP1A0414	KALVA MAHATHEE REDDY	Mahathee	Mahathee
15	19UP1A0415	KANDE LAHARI	K. Lahari	K. Lahari
16	19UP1A0416	KANDULA MEGHANA	K. Meghana	K. Meghana
17	19UP1A0417	KONAKANCHI TEJASWINI	Tejaswini	Tejaswini
18	19UP1A0418	KUNCHETTI PRAVALIKA	Pravalika	Pravalika
19	19UP1A0419	LINGAMPALLY ABHINAYA	Abhinaya	Abhinaya
20	19UP1A0420	MANNE SRAVANI	M. S. Ravani	M. S. Ravani
21	19UP1A0421	NAKKA LAVANYA	N. Lavanya	N. Lavanya
22	19UP1A0422	NEELAM MOHANA PRIYA	Mohana priya	Mohana priya
23	19UP1A0423	PUSHADAPU LAVANYA	Lavanya	Lavanya
24	19UP1A0424	PALLE PAVANI	P. pavani	pavani
25	19UP1A0425	PARIMI PRASANNA LAXMI	Prasanna	Prasanna
26	19UP1A0426	P SINDHU	P. sindhu	P. sindhu
27	19UP1A0427	RAJPUTH MAHESHWARI SINGH	Maheshwari Singh	Maheshwari Singh
28	19UP1A0428	ROWTHU PALLAVI	Pallavi	Pallavi
29	19UP1A0429	SYED TABASSUM	Syed	Syed
30	19UP1A0430	SAKSHI JAYASREE BHAVANI	Bhavana	Bhavana
31	19UP1A0431	SANGOJU SATHWIKHA	Sathwikha	Sathwikha
32	19UP1A0432	SEETHAMMAGARI ANITHA	Anitha	Anitha
33	19UP1A0433	SIVVA AKSHAYA	S. Akshaya	S. Akshaya
34	19UP1A0434	SRIPADA JITYA LAKSHMI YESASWINI	Lakshmi	Lakshmi
35	19UP1A0435	SUGGUNA LIKHITA	Likhitha	Likhitha
36	19UP1A0436	TANKALA HARIKA	Harika	Harika

37	19UP1A0437	THOOMU SREYA REDDY	Sreya Reddy	Sreya Reddy
38	19UP1A0438	UPPULA SHUVALEELA	Shruvaleela	Shruvaleela
39	19UP1A0439	VANAM ASHVITHA REDDY	Ashvith	Ashvith
40	19UP1A0440	VANKUDOTH SANGITHA	Sangitha	Sangitha
41	19UP1A0441	V LAXMI VASUNDHARA	Vasundhara	Vasundhara
42	19UP1A0442	YARASURI GAYATHRI MANASA	Manasa	Manasa
43	20UP5A0401	AKKI PRATHIMA BHARATHI	Bharathi	Bharathi
44	20UP5A0402	EDUGU RAJITHA	Rajitha	Rajitha
45	20UP5A0403	GODAVARTHI ANUSHA	Anusha	Anusha
46	20UP5A0404	GOKA ANUSHA	Anusha	Anusha
47	20UP5A0405	GOPI VARSHA	Varsha	Varsha
48	20UP5A0406	JUPALLY NAVYA SRI	Navya	Navya
49	20UP5A0407	KOLA CHETHANA	Chethana	Chethana
50	20UP5A0408	KOTTHUR DEVI	Devi	Devi
51	20UP5A0409	MUPPANENI SOWMIKA	Sowmi	Sowmi

  
CO ORDINATOR



  
ECE, HOD

Principal  
Vignans Institute of Management & Technology For Women  
Kondapur (V), Ghatkesar (M), Medchal-Maheshwaram (D), Pin-501301  
Telangana State



Vignana's Institute Of Management and Technology For Women  
Work shop on "Application design using IOT & CLOUD services"  
III B.Tech II sem Students List-2021-22  
Branch :ECE-B



S. No	Hall Ticket No	Student Name	Sign of the student- 29/04/22	Sign of the student- 30/04/22
1	19UP1A0443	ANNU PRAGATHI	Pragathi	Pragathi
2	19UP1A0444	ANUMOJU KAVYA	Akavya	A-Kavya
3	19UP1A0446	BANALA SNITHIKA	Snithika	Snithika
4	19UP1A0447	BHIMAVARAPU SIVA NAGA SAI SARANYA	BS	BS
5	19UP1A0448	BOGALA ANUSHA	B-Anusha	B-Anusha
6	19UP1A0449	BOKKA HARSHITHA	Harshittha	Harshittha
7	19UP1A0450	BOKKA VARSHITHA	varshitha	varshitha
8	19UP1A0451	BOLLEPALLY JASHANVI	BS	BS
9	19UP1A0452	CHIMATA MADHAVI	madhavi	madhavi
10	19UP1A0453	DASI VENKATA SAHITHAYA	sahithaya	Sahithaya
11	19UP1A0454	DUGYALA VAISHNAVI	Vaishnavi	Vaishnavi
12	19UP1A0455	G.SHIRISHA	G.shirisha	G.shirisha
13	19UP1A0456	GABALE NISHITHA	BS	BS
14	19UP1A0457	GOURISHETTI HARSHA VARDHINI	Harsha vardhini	Harsha vardhini
15	19UP1A0458	GUMAMALA SNEHA REDDY	G. sneha	G. sneha
16	19UP1A0459	HALDODDI DIVYA	H.Divya	H.Divya
17	19UP1A0460	JANJIRALA ANUSHA	BS	BS
18	19UP1A0461	KARKURI SOWMYA	Sowmya	Sowmya
19	19UP1A0462	KALYANAM MOUNIKA	K.Mounika	k.mounika
20	19UP1A0463	KOMMINENI JASMITHA	BS	BS
21	19UP1A0464	KONDERU SRAVYA	Sravya	Sravya
22	19UP1A0465	LAKAMGARI PRASANNA LAXMI REDDY	BS	BS
23	19UP1A0466	GADDAM LIKHITHA	G.Likhitha	G.Likhitha
24	19UP1A0467	LIMBURE SANTHOSHI	santhoshi	santhoshi
25	19UP1A0468	MALGIREDDY YOGITHA REDDY	BS	BS
26	19UP1A0469	MARVALA DEEPIKA	M.Deepika	M.Deepika
27	19UP1A0470	MEDA BHUVANESWARI	BS	BS
28	19UP1A0471	PADAKULA UMA	Uma	Uma
29	19UP1A0472	RAMIDI DEEKSHITHA	BS	BS
30	19UP1A0473	RAVULA HIRANMAI	R. Hiranmai	R. Hiranmai



Vignana's Institute of Management and Technology For Women  
Kondapur (V.G.) G.P., Nellore District, Andhra Pradesh  
Principal  
R. Hiranmai  
Telangana State

31	19UP1A0474	SHANIGALA CHANDANA	S. Chandana	S. Chandana
32	19UP1A0475	MORAPALLY SIRI CHANDANA REDDY	AB	AB
33	19UP1A0476	SUROJU SRIVAISHNAVI	AB	AB
34	19UP1A0477	TELUKUNTLA SREYA REDDY	Sreya	Sreya
35	19UP1A0478	THAMATAM AKSHITHA	Shorvani	Sharavani
36	19UP1A0479	TURPU SHRAVANI	Akshitha	Akshitha
37	19UP1A0480	VANGETI BANNY	Banny	Banny
38	19UP1A0481	VENNAMANENI ANOUSHIKA	AB	AB
39	19UP1A0482	YEDULLA NAGALAXMI	Nagalaxmi	Nagalaxmi
40	20UP5A0410	NAGARAM ANUSHA	AB	AB
41	20UP5A0411	NAKKA YAMINI	AB	AB
42	20UP5A0412	NATTUVA BHARGAVI	Bhargavi	Bhargavi
43	20UP5A0413	PALASA CHANDANA	Chandana	Chandana
44	20UP5A0414	SANKURI SRAVANI	AB	AB
45	20UP5A0415	T ANUSHA	Anusha	Anusha
46	20UP5A0416	VADDABOINA NAMRATHA	AB	AB
47	20UP5A0417	VADLA SHIVANI	V. shivani	V. shivani
48	20UP5A0418	VINDHYA DARSHINI	Darshini	Darshini
49	20UP5A0419	YAMJALA SHAMILI	Shanili	Shanili

  
CO ORDINATOR

  
ECE, HOD

Head of Department  
Electronics and Communication Engineering  
Vignans Institute of Management & Technology  
Kondapur (V), Ghatkesar (M), Medchal-Malkajgiri (D), 501301  
Telangana State



  
PRINCIPAL  
Vignans Institute of Management & Technology For Women  
Kondapur (V), Ghatkesar (M), Medchal-Malkajgiri (D), 501301  
Telangana State



DEPARTMENT OF ELECTRONICS AND COMMUNICATION ENGINEERING

Date: 04-05-2022

Conclusion report on “Application Design Using IOT and Cloud Services”

**Sub:** conclusion Report of “Application Design Using IOT and Cloud Services”

conducted on 29& 30 April, 22 reg.

The workshop was aimed to provide knowledge about application design using iot and cloud services.

Mr. K.Jagadeswar reddy *Elegant Embedded solutions PVT LTD, HYD*, executed 2-days Workshop on “Application Design Using IOT and Cloud Services” workshop. After attending this workshop students have expressed about their capability of Designing Special purpose IOT Devices Design and applications in any Electronics Project. This workshop will be helpful for students for circuit development of their final year project. Total 84 students have participated in this workshop. The workshop was an informative and interesting. All the students of ECE had a practical exposure about IOT and Cloud services and its applications.

On behalf of the students I request you to arrange more workshops for students to improve the knowledge of students and enhance the career opportunities.

Mr.Sunilkumar .J

Associate Professor, ECE.

VMTW ,Ghatkesar,HYD.

PRINCIPAL  
Vignani's Institute of Management & Technology For Women  
Kondapur(V), Ghatkesar(M), Medchal-Maikalgiri(DT)-Hyd ...  
Telangana State





**DEPARTMENT OF ELECTRONICS AND COMMUNICATION ENGINEERING**

VMTW/ECE/WS/CIR/2019-20/1/2

Date: 12-08-2019

**CIRCULAR**

This is to inform all the Staff, and II B.Tech ECE Students that there will be a Workshop on entitled "Practical usage of Spread Spectrum Modulation" in association with **Elegant Embedded Solutions Pvt. Ltd**, from 19-08-2019 to 20-08-2019 at B-Block Seminar Hall by Mr. K.Jagadeswar reddy, R&D Engineer in **Elegant Embedded Solutions Pvt. Ltd, HYD**.

All students are invited to take part in this Workshop. The participating students will be honored with certificates of participation. During the Workshop you will be encouraged to interact with the speaker and the other participants through the case study discussions.

HOD

Copy to:

The Principal, for kind information

IQAC

Dept. File

Circular to II ECE Class Room

PRINCIPAL

Vignans Institute of Management & Technology For Women  
Kondapur(V), Ghatkesar(M), Medchal-Malkajgiri(D)-501301  
Telangana State



Request to conduct a workshop in our college

Dept. of ECE VMTW <ece@vmtw.in>

Wed Aug, 2<sup>nd</sup>, 2019 at 10:44 AM

To: < itrajusankar@gmail.com >

Respected sir,

I am Mr Vijaykumar Rewnath Urkude,, HOD , Dept of ECE , Vignan's Institute Of Management And Technology For Women, Ghatkesar, Hyderabad, Telangana. We are planning to conduct a two day workshop on "Practical Usage of spread spectrum modulation in mobile communication" on 19<sup>th</sup> and 20<sup>th</sup> August 2019 to enhance the knowledge of the students. I request to send approval for conducting workshop

Thanking you

Thanks Regards  
Vijaykumar Rewnath Urkude  
Assoc. Prof & HOD,  
Dept. of ECE, VMTW  
Contact: 92937 93986



  
PRINCIPAL  
Vignan's Institute of Management & Technology For Women  
Kondapur(V), Ghatkesar(M), Medchal-Malkajgiri(Dt)-501301  
Telangana State



< itrajusankar@gmail.com >

**Regarding work shop approval**

< itrajusankar@gmail.com >

To: Dept. of ECE VMTW <ece@vmtw.in>

05th, Aug, 2019 at 11:02 AM

Sir/Madam,

Sub: approved for organizing workshop  
Hence further enhancement of students knowledge we have approved the organization to conduct a two day workshop on  
"Practical usage of spread spectrum modulation in mobile communication".

With Regards,  
Mr. I. Sankara Rao,  
R&D Engineer, Elegant Embedded Solutions,  
Hyderabad.



  
**PRINCIPAL**  
Vignana's Institute of Management & Technology For  
Kondapur(V), Ghatkesar(M), Medchal-Malkajgiri(DT)-501301  
Telangana State

# REGISTRATION FORM

Name: .....

Date of Birth & Age: .....

Gender (M/F): .....

Qualifications: .....

Institution: .....

Affiliating University: .....

Address for Communication: .....

Phone Nos. ....

Mobile: .....

Personal: .....

Email: .....

Resource Person:  
**Mr. I. Sankara Rao,**  
R&D Engineer, Elegant Embedded Solutions,  
Hyderabad.

Chief-patrons:  
**Dr. L. Rathaiah,**  
Chairman,  
Vignan Group of Institutions.

**Mr. B. Shravan,**  
Chief Executive Officer,  
Vignan Group of Institutions

Patron:  
**Dr. P. Sudhakara Rao,**  
Principal, VMTW

**Mr. Vijaykumar Rewnath Urkude**  
Associate Professor &  
Head of the Department, ECE.

Co-ordinator:  
**Mr. E. Nagaraju**  
Assistant Professor,  
Dept. of ECE,  
Contact No: +91 85000 37493

Student Co-ordinator:  
**Ms. Meda Bhuvaneshwari**  
Contact No: +91 93900 81001

**Ms. V. Anoushika**  
Contact No: +91 93900 86199



(Sponsored by Law Education Society)  
Approved by AICTE, New Delhi & Affiliated to JNTUH, Hyderabad.  
Kondapur (V), Ghatkesar (M), Medchal - Malkajgiri (D) - 501 301

A TWO DAY WORKSHOP ON  
**“PRACTICAL USAGE OF  
SPREAD SPECTRUM  
MODULATION IN MOBILE  
COMMUNICATION”**  
19<sup>TH</sup> & 20<sup>TH</sup> AUGUST, 2019



VENUE:  
**'B'-BLOCK SEMINAR HALL, VMTW**

ORGANIZED BY:  
**DEPARTMENT OF ELECTRONICS AND  
COMMUNICATION ENGINEERING**



**LAST DATE FOR REGISTRATION: 17<sup>TH</sup> AUGUST, 2019**

[www.vmtw.in](http://www.vmtw.in)

### ABOUT THE INSTITUTION

Vignan's Institute of Management and Technology for Women (VMTW), is the brainchild of Dr. L. Rathalah, Chairman, Vignan Group of Institutions, which was founded August 2008, with four branches of Engineering.

VMTW is an exemplary institution of higher learning with a passion of pursuing excellence in education and research. The institution, with its diverse and dynamic community of about 2000 students offers a distinctive combination of some of the finest facilities for 7 different graduate, and undergraduate programs, accomplished faculty, world-class facilities with a hostel set on a sprawling area of 22 acres in lush green surroundings of mango groves and greenery.

While students at VMTW immerse themselves in academics, the college has a lot in store for them outside the classroom. Student life includes participation in sports, recreational & extra-curricular, and cultural activities. In short, at VMTW students will find an academic and social environment where everyone from faculty members to peers helps shape their future.

VMTW is a home to aesthetically designed buildings with state-of-the-art computer and internet facilities, modern laboratories, workshops, seminar halls, auditoriums, and well-stocked libraries, sports, and games fields.

The institution boasts of a strong alumni network with annual events held every year serving as a platform for past students to give back to VMTW and share their experiences with their present fellow students. With so much to offer, it is only natural that students of VMTW get a unique opportunity to carve a niche for themselves in their chosen field of study. It enables them to become well-rounded and discerning professionals, fully qualified for their chosen professions in the workplace. Institute also brings out the creativity in students by imparting engineering knowledge imbuing with personal skills to promote innovation, research, and entrepreneurship.

### ABOUT THE DEPARTMENT

The Department of Electronics and Communication Engineering was started since the inception of Vignan's Institute of Management and Technology for Women during 2008 with an initial intake of 90. The strength was enhanced to 120 during 2010. The Department had added Post graduate programme in VLSI during the year 2011 and Embedded Systems during 2014 with an intake of 18 each.

The Department has state-of-art laboratories equipped with advanced and well maintained equipment, continuously updated application software packages, more than adequate computing systems with 24x7, 30 MBPS internet facility.

### ABOUT THE COURSE

A spread spectrum communications system is one that is built upon the principle of transmitting information signals over a much wider bandwidth than is strictly necessary for transferring the information. By transmitting over a larger bandwidth, robustness against external narrowband interference is increased, since the wider the bandwidth of any transmitted signal the lower will be the relative influence of interference over a small part of the bandwidth.

### COURSE OBJECTIVES

The spreading sequence may in principle be a sequence of random chips. If this is the case, then transmissions to/from different users may be assigned different random sequences. In order to detect a sequence transmitted to or from a particular user, the total received signal, which will consist of aggregation of all users' sequences, can be correlated with the users' spreading code at the receiver side. In this case, the target user's signal will experience a combining gain across the M chips, whereas the other users' signals will not and hence appear as uncorrelated noise. This combining gain is referred to as spreading gain.

### EXPECTED OUTCOMES

- At the end of Workshop, participants will be able to
- Code Division Multiple Access (CDMA)
  - Quartz-based piezoelectric materials.
  - Direct Sequence Spread Spectrum Communications.



*[Signature]*

PRINCIPAL

Vignan's Institute of Management & Technology For Women  
Kondapur (V), Medchal-Malkajgiri (DI), Pin-501301, T.S.



# VIGNAN'S INSTITUTE OF MANAGEMENT AND TECHNOLOGY FOR WOMEN

Sponsored by Lavu Educational Society, Approved by AICTE, New Delhi & Affiliated to JNTUH, Hyderabad.  
Kondapur (V), Ghatkesar (M), Medchal - Malkajgiri (D) - 501 301 Phone: +91 96529 10002/3



## WORKSHOP ON



# PRACTICAL USAGE OF SPREAD SPECTRUM MODULATION IN MOBILE COMMUNICATION

19<sup>TH</sup> & 20<sup>TH</sup> AUGUST, 2019

DEPARTMENT OF ELECTRONICS AND COMMUNICATION ENGINEERING



*[Signature]*  
PRINCIPAL

Vignan's Institute of Management & Technology For Women  
Kondapur(V), Ghatkesar(M), Medchal-Malkajgiri(D)-501301  
Telangana State



Vignan's Institute Of Management and Technology For Women  
Work shop on "Practical usage of spread spectrum modulation in mobile communication"  
II B.Tech I sem Students List-2019-20  
Branch :ECE-A



S. No	Hall Ticket No	Student Name	Sign of the student-19/08/19	Sign of the student-20/08/19
1	18UPIA0401	ADDANKI DHARANI	Dharani	Dharani
2	18UPIA0402	ADUSUMILLI SRILASYA	Ab	Sri
3	18UPIA0403	ARROJU VAISHNAVI	vaishnavi	vaishnavi
4	18UPIA0404	BANDARI MOUNIKA	Mouni	AD
5	18UPIA0405	BATTULA SANGEETHA	Sangeetha	Sangeetha
6	18UPIA0406	CHINTAKUNTA RASAGNA	Ra Sagna	Rasagna
7	18UPIA0407	DAMMANNAPETA SOUJANYA	Soujy	AD
8	18UPIA0408	DESHAM SRIVANI	Sri Vanu	Sri Vanu
9	18UPIA0409	DIGAJARLA SNEHITHA	Sneha	Sneha
10	18UPIA0410	GAMPALA MADHURI	madhury	madhury
11	18UPIA0412	GANDHE AKANKSHA	akanksha	akanksha
12	18UPIA0413	GANNA KAVYA	Kavya	Kavya
13	18UPIA0414	GATTU MOUNIKA	Mouni	Ab
14	18UPIA0415	GIRINENI DIVYA	Divya	Divya
15	18UPIA0417	GUNTUPALLI MIDHUNA	Midhuna	Midhuna
16	18UPIA0418	GURUGUBELLI SUSHMA	Sushma	Sushma
17	18UPIA0419	JAGINI SHARANYA	Sharanya	Sharanya
18	18UPIA0420	JANAGAMA SRIVIDHYA	Vidya	AD
19	18UPIA0421	JOGIRAJU AKSHARA	AKshara	AKshara
20	18UPIA0422	JONNALAGADDA DEEPTHI	Deepti	Deepti
21	18UPIA0423	K HARIPRIYA	Hari Priya	Hari Priya
22	18UPIA0424	KANCHARLA SRUTHI	Sruthi	Sruthi
23	18UPIA0425	KONAMUTLA JHANSI	Jhansi	Jhansi
24	18UPIA0426	KOTA LIKHITHA	Likhitha	Likhitha
25	18UPIA0427	KOTHA SWATHI	Swathi	Swathi
26	18UPIA0428	KOTLA SONY	Sony	Sony
27	18UPIA0429	KOTTAM AKHILA	Akhila	Akhila
28	18UPIA0430	KUNTA DEEPIKA	DeePiKa	DeePiKa
29	18UPIA0431	LADALLA PAVANI	Pavani	Pavani
30	18UPIA0432	MADDI SRIVIDYA	Vidya	AD
31	18UPIA0433	MALAMANTI MOUNIKA	Mouni	Mouni
32	18UPIA0434	MAREPALLY ADITI SAI	Sai	Sai
33	18UPIA0435	MITTA AKSHITHA	Akshitha	Akshitha
34	18UPIA0436	MOROJU KUSUMA	Kusuma	Kusuma
35	18UPIA0437	MOTAMARRI MEGHANA	Meghana	Meghana
36	18UPIA0438	N GAYATHRI	Gayathri	Gayathri
37	18UPIA0439	N RUPARANI	Rupa	Ab
38	18UPIA0440	NACHU SHIVANI	Shivani	Shivani
39	18UPIA0442	PEDDI AISHWARYA	Ab	Aishwarya
40	18UPIA0443	PULUSANI VARUNITHA	Varu	AD



PRINCIPAL

Vignan's Institute of Management & Technology For Women  
Kothakota(V), Ghatkesar(M), Medchal-Malkajgiri(DT)-501301  
Telangana State

41	18UP1A0444	REDDYGARI JAHNAVI REDDY	Janu	Janu
42	18UP1A0445	SAMALA POOJA	Pooja	Pooja
43	18UP1A0446	SHAIK ZEENATH	Sh	Zeenaath
44	18UP1A0447	SINGIRIKONDA AISHWARYA	Aishi	Aishi
45	18UP1A0448	SUKKA SHARANYA	Sharanya	Sharanya
46	18UP1A0449	SUNKARABOINA AMOOL SIRI	Siri	Siri
47	18UP1A0450	TANGUTURI NIHARIKA	Niha	Nim
48	18UP1A0451	VEERAMALLA MANASA	Manasa	Manasa
49	18UP1A0452	VUPPUGANDLA SREEJA	Sreeja	Sreeja
50	18UP1A0453	YELLOJU SRAVANI	Sravani	Sravani
51	19UP5A0401	ABRABOINA SAIKUMARI	Sai	Sai
52	19UP5A0402	ADEPU SHIVANI	Shivani	Shivani
53	19UP5A0403	BANDI JHANSI	Jhansi	Jhansi
54	19UP5A0404	BATHINI NIVEDITHA	Nidetha	Nidetha
55	19UP5A0405	BODDIREDDY RAVALI	Ravi	Ravi

*Nallip*  
CO ORDINATOR

*Riteeda*  
ECE, IOD

Head of the Department  
Electronics and Communication  
Institute of Management & Technology  
Kondapur (V), Ghatkesar (M), Medchal  
Pin-501301, T.S.



*Vignee*  
PRINCIPAL  
Vignee's Institute of Management & Technology For Women  
Kondapur(V), Ghatkesar(M), Medchal-Malkajgiri(Dt)-501301  
Telangana State





Vignan's Institute Of Management and Technology For Women  
 Work shop on "Practical usage of spread spectrum modulation in mobile communication"  
 II B.Tech I sem Students List-2019-20  
 Branch :ECE-B



S. No	Hall Ticket No	Student Name	Sign of the student-19/08/19	Sign of the student-20/08/19
1	18UPIA0454	ARSHIA JABEEN	Jabeen	Jabeen
2	18UPIA0455	ATLURU SINDHUJA	Sindhuja	Sindhuja
3	18UPIA0456	B SOUMYA	B. Soumya	B. Soumya
4	18UPIA0457	MOTUPALLI BHAVANA SAI PRIYA	Bhavana	Bhavana
5	18UPIA0458	BODDIREDDY SAI ASHRITHA	Ashritha	Ashritha
6	18UPIA0459	B ABHIGNA	Abhigna	Abhigna
7	18UPIA0460	BOGGULA VENKATA KRISHNA	Krishna	Krishna
8	18UPIA0461	BORRA LIKITHA	Likitha	Likitha
9	18UPIA0462	C KAVYA SREE	C. Sree	C. Sree
10	18UPIA0463	CHALASANI SRI SAI BHUVANESWARI	Bhuvaneshwari	Bhuvaneshwari
11	18UPIA0464	CHALLA TEJASWINI	Tejaswini	Tejaswini
12	18UPIA0465	GADUSU NAVYA	Navya	Navya
13	18UPIA0466	GUMMADEELA LAKSHMI PRASANNA	Prasanna	Prasanna
14	18UPIA0467	GURRAM SRAVANTHI	Sravanthi	Sravanthi
15	18UPIA0468	JAKKA DEEPTHI	Deepthi	Deepthi
16	18UPIA0469	JAKKA KEERTHI	Keerthi	Keerthi
17	18UPIA0471	KANDADI POOJA	Pooja	Pooja
18	18UPIA0472	KARI DIVYA SRI SAI DURGA	Durga	Durga
19	18UPIA0473	KODALI RUPA	Rupa	Rupa
20	18UPIA0474	KOLA SNIGDHA	Snigdha	Snigdha
21	18UPIA0475	KOPPULA BHAVANA	Bhavana	Bhavana
22	18UPIA0476	KURREMULA SAI SOWJANNYA	Sowjanya	Sowjanya
23	18UPIA0477	MALKEYAGARU SATHWIKAREDDY	Sathwikareddy	Sathwikareddy
24	18UPIA0478	MANDALA SHRESTA	Shresta	Shresta
25	18UPIA0479	MARAMPALLY APOORVA	Apoorva	Apoorva
26	18UPIA0480	MOMULA VASANTHA LAXMI	Vasantha	Vasantha
27	18UPIA0481	MULLAPUDI YOSHITHA NAGA SAI LAKSHMI	Lakshmi	Lakshmi
28	18UPIA0482	NANDYALA VARSHITHA	Varshitha	Varshitha
29	18UPIA0483	PODURI MEHER SESHASREE	Meher	Meher
30	18UPIA0484	PESARU SHIVANI	Shivani	Shivani
31	18UPIA0486	PAMIDIGHANTAM NAGA VJAYA VYSHNAVI	Vyshnavi	Vyshnavi
32	18UPIA0487	PAPPULA VARSHITHA	Varshitha	Varshitha
33	18UPIA0488	PEDDI RASHMITHA	Rashmitha	Rashmitha
34	18UPIA0489	PEDDIREDDY PRAVALIKA	Pravalika	Pravalika
35	18UPIA0490	PENDYALA BHOOMIKA	Bhoomika	Bhoomika
36	18UPIA0491	POCHAMPALLI HARINI	Harini	Harini
37	18UPIA0492	PODDUTURI ANVITHA	Anvitha	Anvitha
38	18UPIA0493	POTHUGANTI MADHUNITHA	Madhunitha	Madhunitha
39	18UPIA0494	PULLURU SRAVANI	Sravani	Sravani
40	18UPIA0495	PYATA PRANANI	Pranani	Pranani
41	18UPIA0496	SANTI SREEJA REDDY	Sreeja	Sreeja
42	18UPIA0497	SARANGA NAVYA	Navya	Navya



Principal  
 Vignan's Institute of Management and Technology For Women  
 Kandapur (V), Ghanesar (M), Madchal, Malkajgiri (Dr), Pin-501301  
 19-08-2019

43	18UP1A0498	SAVIRIGAM SRAVYA	SRVYA	SRVYA
44	18UP1A0499	SUDHAGONI SINDHU	SINDHU	SINDHU
45	18UP1A04A0	TENKASALA SHRUTHI MADHURI	SHRUTHI	SHRUTHI
46	18UP1A04A1	VEERAMREDDY SATVIKA	SATVIKA	SATVIKA
47	18UP1A04A2	VUYYALA SREEJA	SREEJA	SREEJA
48	18UP1A04A3	YERRA SUSHMITHA	SUSHMITHA	SUSHMITHA
49	19UP5A0408	K RENUKA	K RENUKA	K RENUKA
50	19UP5A0409	NIMMA JHANSI	JHANSI	JHANSI
51	19UP5A0410	NURCHU SHIRISHA	SHIRISHA	SHIRISHA
52	19UP5A0411	NUTENKI SINDHU	SINDHU	SINDHU
53	19UP5A0412	POOSALA KEERTHY	KEERTHY	KEERTHY
54	19UP5A0413	S. AKHILA	AKHILA	AKHILA
55	19UP5A0414	VORUGANTI AKANKASHA	AKANKASHA	AKANKASHA
57	19UP5A0407	GANDHARI SHAILAJA	SHAILAJA	SHAILAJA

*Nalini*  
CO ORDINATOR

*Vertecla*  
ECE, HOD  
Head of the Department

Electronics  
Vignans Institute of Management & Technology For Women  
Kondapur (V), Ghatkesar (M), Medchal-Malkajgiri (Dt),  
Pin-501301, T.S.



*Wah*

PRINCIPAL

Vignans Institute of Management & Technology For Women  
Kondapur(V), Ghatkesar(M), Medchal-Malkajgiri(Dt),  
Telangana State



VIGNAN'S INSTITUTE OF MANAGEMENT AND  
TECHNOLOGY FOR WOMEN  
Kondapur (V), Ghatkesar (M), Medchal, Dist - 501 301.



DEPARTMENT OF ELECTRONICS AND COMMUNICATION ENGINEERING

Date: 26-08-2019

Conclusion report on "Practical usage of spread spectrum modulation in mobile communication"

Sub: Conclusion Report of "Practical usage of spread spectrum modulation in mobile communication"

Conducted on 19& 20 August, 19—reg.

The workshop was aimed to provide knowledge about application design using iot and cloud services.

Mr. K.Jagadeswar reddy, R&D Engineer, Elegant Embedded Solutions, Hyderabad., executed 2-days Workshop on "Practical usage of spread spectrum modulation in mobile communication" and applications workshop. After attending this workshop students have expressed about their capability of Practical usage of spread spectrum modulation in mobile communication applications in any Electronics Project. This workshop will be helpful for students for circuit development of their final year project. Total 112 students have participated in this workshop. The workshop was an informative and interesting. All the students of ECE had a practical exposure about Practical usage of spread spectrum modulation in mobile communication

On behalf of the students I request you to arrange more workshops for students to improve the knowledge of students and enhance the career opportunities

Mr. E.Nagaraju

Assistant Professor, ECE.

VMTW ,Ghatkesar,HYD.



PRINCIPAL

Vignani's Institute of Management & Technology For Women  
Kondapur(V),Ghatkesar(M),Medchal-Malkajgiri(Dt)-501301  
Telangana State



**DEPARTMENT OF ELECTRONICS AND COMMUNICATION ENGINEERING**

VMTW/ECE/IV/CIR/2021-22/2/1

Date: 25-04-2022

**CIRCULAR**

All the III B.Tech ECE Students Concerned faculties are informed the department in organizing an **Industrial Visit** from 27-04-2022 and 28-04-2022.

Department Time : 09:00 AM  
Arrival Time : 04: 00 PM  
Name of Company : **Elegant Embedded Solutions Pvt. LTD**

The following faculty members will coordinate the above event.

1. Dr. SK. Masthan Basha
2. Mr. J. Sunil Kumar
3. Mrs. K. Mamatha
4. Mr. K. Ashok Reddy



  
HOD

  
PRINCIPAL

Vignan's Institute of Management & Technology For Women  
Kondapur(V),Ghatkesar(M),Medchal-Malkajgiri(D)-501301  
Telangana State



Dept. of ECE VMTW <ece@vmtw.in>

### Request for Industrial Visit to our B.Tech Students

2 messages

Dept. of ECE VMTW <ece@vmtw.in>  
To: info@elegantembedded.com

Sat, Apr 23, 2022 at 2:58 PM

Respected Sir,

Greetings from Vignan!

I am P.Harikrishna from the Vignan group of institutions, Hyderabad. we are very much interested in bringing our students to your esteemed organization for an industrial visit. We assure you that we would not disturb your regular work/production and conduct our students with utmost discipline.

I request you to kindly grant permission for our 100 students of the ECE department to visit on two different days, by accommodating 50 students on each day.

**Proposed date of visit : 27-04-2022 & 28-04-2022**

Please find the attachment.

**Thanks & Regards**  
**P. Harikrishna**  
Assoc. Prof & HOD,  
Dept. of ECE, VMTW  
Contact: 7093246048

ELEGANT EMBEDDED SOLUTIONS PVT LTD <info@elegantembedded.com>  
To: "Dept. of ECE VMTW" <ece@vmtw.in>

Sat, Apr 23, 2022 at 5:03 PM

Dear Harikrishna sir,  
Thank you for your interest in visiting our company.  
We will share our industrial experience and showcase some products to your students on respected dates.

**With Regards,**  
Elegant Embedded Solutions Pvt Ltd,  
9985784340, 9396671541,  
www.elegantembedded.com

[Quoted text hidden]



*Handwritten signature*  
**PRINCIPAL**  
Vignan's Institute of Management & Technology For Women  
Kondapur (V), Ghatkesar (M), Medchal-Malkajgiri (Dt), Pin-501301, T.S.



Dept. of ECE VMTW <ece@vmtw.in>

### Request for Industrial Visit to our B.Tech Students

ELEGANT EMBEDDED SOLUTIONS PVT LTD <info@elegantembedded.com>  
To: "Dept. of ECE VMTW" <ece@vmtw.in>

Sat, Apr 23, 2022 at 5:03 PM

Dear Harikrishna sir ,  
Thank you for your interest in visiting our company .  
We will share our industrial experience and showcase some products to your students on respected dates.

With Regards,  
Elegant Embedded Solutions Pvt Ltd,  
9985784340, 9396671541,  
www.elegantembedded.com

[Quoted text hidden]



*SASH*  
**PRINCIPAL**  
Vignan's Institute of Management & Technology For Women  
Kondapur(V),Ghatkesar(M),Medchal-Malkajgiri(D)-501301  
Telangana State



# VIGNAN'S INSTITUTE OF MANAGEMENT AND TECHNOLOGY FOR WOMEN

(Sponsored by Vignans Educational Society)  
(Affiliated to JNTU/H, Hyderabad & Approved by AICTE, New Delhi)



Date: 27-04-2022

To  
The Managing director,  
*Elegant Embedded solutions Pvt LTD.*  
93,phase II,IDA,CHERELAPALLY,,  
Hyderabad 500051, INDIA  
<https://www.elegantembedded.com>

The Following the students are visit your organization

S. No	Hall Ticket No	Student Name
1	19UPIA0401	ARKALA SNEHA REDDY
2	19UPIA0402	BANDI RASAGNA
3	19UPIA0403	BASWA VIGNATHA
4	19UPIA0404	BELLI PAVANI
5	19UPIA0405	B V SHIVA KEERTHIKA
6	19UPIA0406	DIWAKARLA SAI LAKSHMI SRAVYA
7	19UPIA0407	GAJULA ABHIGNA
8	19UPIA0408	GADDAM LIKHITHA
9	19UPIA0409	GIRUGUBOTHALA SAI DEEPTHI
10	19UPIA0410	GOLLA PRIYANKA
11	19UPIA0411	GOURISHETTI SWETHA
12	19UPIA0412	KOPPELA NISHITHA
13	19UPIA0413	KALAVA CHARITHA
14	19UPIA0414	KALVA MAHATHEE REDDY
15	19UPIA0415	KANDE LAHARI
16	19UPIA0416	KANDULA MEGHANA
17	19UPIA0417	KONAKANCHI TEJASWINI
18	19UPIA0418	KUNCHETTI PRAVALIKA
19	19UPIA0419	LINGAMPALLY ABHINAYA
20	19UPIA0420	MANNE SRAVANI
21	19UPIA0421	NAKKA LAVANYA
22	19UPIA0422	NEELAM MOHANA PRIYA
23	19UPIA0423	PUSHADAPU LAVANYA
24	19UPIA0424	PALLE PAVANI
25	19UPIA0425	PARIMI PRASANNA LAXMI
26	19UPIA0426	P SINDHU
27	19UPIA0427	RAJPUTH MAHESHWARI SINGH
28	19UPIA0428	ROWTHU PALLAVI
29	19UPIA0429	SYED TABASSUM

S. No	Hall Ticket No	Student Name
30	19UP1A0430	SAKSHI JAYASREE BHAVANI
31	19UP1A0431	SANGOJU SATHWIKI
32	19UP1A0432	SEETHAMMAGARI ANITHA
33	19UP1A0433	SIVVA AKSHAYA
34	19UP1A0434	SRIPADA JITYA LAKSHMI YESASWINI
35	19UP1A0435	SUGGUNA LIKHITA
36	19UP1A0436	TANKALA HARIKA
37	19UP1A0437	THOOMU SREYA REDDY
38	19UP1A0438	UPPULA SHUVALEELA
39	19UP1A0439	VANAM ASHVITHA REDDY
40	19UP1A0440	VANKUDOTH SANGITHA
41	19UP1A0441	V LAXMI VASUNDHARA
42	19UP1A0442	YARASURI GAYATHRI MANASA
43	20UP5A0401	AKKI PRATHIMA BHARATHI
44	20UP5A0402	EDUGU RAJITHA
45	20UP5A0403	GODAVARTHI ANUSHA
46	20UP5A0404	GOKA ANUSHA
47	20UP5A0405	GOPI VARSHA
48	20UP5A0406	JUPALLY NAVYA SRI
49	20UP5A0407	KOLA CHETHANA
50	20UP5A0408	KOTTHUR DEVI
51	20UP5A0409	MUPPANENI SOWMIKA

Page No 02



PRINCIPAL

PRINCIPAL

Vignans Institute of Management and Technology for Women  
Kondapur (V), Ghadkassar (M), Medchal-Malkajgiri (D) - 501301  
Telangana State

PRINCIPAL

Vignans Institute of Management & Technology For Women  
Kondapur(V),Ghadkassar(M),Medchal-Malkajgiri(D)-501301  
Telangana State





# VIGNAN'S INSTITUTE OF MANAGEMENT AND TECHNOLOGY FOR WOMEN

(Sponsored by Fort Education Society)

(Affiliated to JNTU, Hyderabad & Approved by AKTC, New Delhi)



To  
The Managing director,  
Elegant Embedded solutions Pvt LTD,  
93,phase II,IDA,CHERELAPALLY,,  
Hyderabad 500051, INDIA  
<https://www.elegantembedded.com>

Date: 27-04-2022

The Following the students are visit your organization

S. No	Hall Ticket No	Student Name
1	19UPIA0443	ANNU PRAGATHI
2	19UPIA0444	ANUMOJU KAVYA
3	19UPIA0446	BANALA SNITHIKA
4	19UPIA0447	BHIMAVARAPU SIVA NAGA SAI
5	19UPIA0448	BOGALA ANUSHA
6	19UPIA0449	BOKKA HARSHITHA
7	19UPIA0450	BOKKA VARSHITHA
8	19UPIA0451	BOLLEPALLY JASHANVI
9	19UPIA0452	CHIMATA MADHAVI
10	19UPIA0453	DASI VENKATA SAHITHAYA
11	19UPIA0454	DUGYALA VAISHNAVI
12	19UPIA0455	G.SHIRISHA
13	19UPIA0456	GABALE NISHITHA
14	19UPIA0457	GOURISHETTI HARSHA VARDHINI
15	19UPIA0458	GUMAMALA SNEHA REDDY
16	19UPIA0459	HALDODDI DIVYA
17	19UPIA0460	JANJIRALA ANUSHA
18	19UPIA0461	KARKURI SOWMYA
19	19UPIA0462	KALYANAM MOUNIKA
20	19UPIA0463	KOMMINENI JASMITHA
21	19UPIA0464	KONDERU SRAVYA
22	19UPIA0465	LAKAMGARI PRASANNA LAXMI
23	19UPIA0466	GADDAM LIKHITHA
24	19UPIA0467	LIMBURE SANTHOSHI
25	19UPIA0468	MALGIREDDY YOGITHA REDDY
26	19UPIA0469	MARVALA DEEPIKA
27	19UPIA0470	MEDA BHUVANESWARI
28	19UPIA0471	PADAKULA UMA
29	19UPIA0472	RAMIDI DEEKSHITHA

Page No 01



*(Signature)*  
PRINCIPAL  
Vignans Institute of Management & Technology For Women  
Kondapur(V),Ghatkesar(M),Medchal(TQ)

S. No	Hall Ticket No	Student Name
30	19UP1A0473	RAVULA HIRANMAI
31	19UP1A0474	SHANIGALA CHANDANA
32	19UP1A0475	MORAPALLY SIRI CHANDANA REDDY
33	19UP1A0476	SUROJU SRIVAISHNAVI
34	19UP1A0477	TELUKUNTLA SREYA REDDY
35	19UP1A0478	THAMATAM AKSHITHA
36	19UP1A0479	TURPU SHRAVANI
37	19UP1A0480	VANGETI BANNY
38	19UP1A0481	VENNAMANENI ANOUSHIKA
39	19UP1A0482	YEDULLA NAGALAXMI
40	20UP5A0410	NAGARAM ANUSHA
41	20UP5A0411	NAKKA YAMINI
42	20UP5A0412	NATTUVA BHARGAVI
43	20UP5A0413	PALASA CHANDANA
44	20UP5A0414	SANKURI SRAVANI
45	20UP5A0415	T ANUSHA
46	20UP5A0416	VADDABOINA NAMRATHA
47	20UP5A0417	VADLA SHIVANI
48	20UP5A0418	VINDHYA DARSHINI
49	20UP5A0419	YAMJALA SHAMILI

Page No 02

  
PRINCIPAL

PRINCIPAL  
Vignn's Institute of Management and Technology for Women  
Kondapur (V), Ghatkesar (M), Medchal-Malkajgiri (T), Telangana State



  
PRINCIPAL

Vignn's Institute of Management & Technology for Women  
Kondapur (V), Ghatkesar (M), Medchal-Malkajgiri (T), Telangana State



Vignans Institute Of Management and Technology For Women

III B.Tech II sem Students List-2021-22

Branch :ECE-A



S. No	Hall Ticket No	Student Name	sign
1	19UPIA0401	ARKALA SNEHA REDDY	Ahulakreddy
2	19UPIA0402	BANDI RASAGNA	B.Rasagna
3	19UPIA0403	BASWA VIGNATHA	B
4	19UPIA0404	BELLI PAVANI	B
5	19UPIA0405	B V SHIVA KEERTHIKA	Bhivakeerthika
6	19UPIA0406	DIWAKARLA SAI LAKSHMI SRAVYA	Sravya
7	19UPIA0407	GAJULA ABHIGNA	Abhigna
8	19UPIA0408	GADDAM LIKHITHA	Likhitha
9	19UPIA0409	GIRUGUBOTHALA SAI DEEPTHI	G.Saideepthi
10	19UPIA0410	GOLLA PRIYANKA	G.Priyanka
11	19UPIA0411	GOURISHETTI SWETHA	Swetha
12	19UPIA0412	KOPPELA NISHITHA	Nishitha
13	19UPIA0413	KALAVA CHARITHA	Charitha
14	19UPIA0414	KALVA MAHATHEE REDDY	Mahathee
15	19UPIA0415	KANDE LAHARI	K.Lahari
16	19UPIA0416	KANDULA MEGHANA	Meghana
17	19UPIA0417	KONAKANCHI TEJASWINI	Tejaswini
18	19UPIA0418	KUNCHETTI PRAVALIKA	Pravalika
19	19UPIA0419	LINGAMPALLY ABHINAYA	L.Abhinaya
20	19UPIA0420	MANNE SRAVANI	M.Sravani
21	19UPIA0421	NAKKA LAVANYA	N.Lavanya
22	19UPIA0422	NEELAM MOHANA PRIYA	P
23	19UPIA0423	PUSHADAPU LAVANYA	P.Lavanya
24	19UPIA0424	PALLE PAVANI	P
25	19UPIA0425	PARIMI PRASANNA LAXMI	Prasanna
26	19UPIA0426	P SINDHU	P.Sindhu
27	19UPIA0427	RAJPUTH MAHESHWARI SINGH	R.Mahi.
28	19UPIA0428	ROWTHU PALLAVI	Pallavi
29	19UPIA0429	SYED TABASSUM	Tabassum
30	19UPIA0430	SAKSHI JAYASREE BHAVANI	Jayasree
31	19UPIA0431	SANGOJU SATHWIKA	Sathwika
32	19UPIA0432	SEETHAMMAGARI ANITHA	Anitha
33	19UPIA0433	SIVVA AKSHAYA	Akshaya
34	19UPIA0434	SRIPADA JITYA LAKSHMI YESASWINI	S.Jaya
35	19UPIA0435	SUGGUNA LIKHITA	L
36	19UPIA0436	TANKALA HARIKA	Harika
37	19UPIA0437	THOOMU SREYA REDDY	S
38	19UPIA0438	UPPULA SHUVALEELA	Ushivaleela
39	19UPIA0439	VANAM ASHVITHA REDDY	Ashvitha
40	19UPIA0440	VANKUDOTH SANGITHA	V.Sangitha



PRINCIPAL

Vignans Institute of Management & Technology For Women  
Kondepur(V),Bhatkasa(M),Medchal-Malkajgiri(DI-561305)  
Telangana State

S. No	Hall Ticket No	Student Name	sign
41	19UP1A0441	V LAXMI VASUNDHARA	V. L. Vasundhara
42	19UP1A0442	YARASURI GAYATHRI MANASA	Y. Gayathri Manasa
43	20UP5A0401	AKKI PRATHIMA BHARATHI	A. Prathima Bharathi
44	20UP5A0402	EDUGU RAJITHA	E. Rajitha
45	20UP5A0403	GODAVARTHI ANUSHA	G. Anusha
46	20UP5A0404	GOKA ANUSHA	G. Anusha
47	20UP5A0405	GOPI VARSHA	G. Varsha
48	20UP5A0406	JUPALLY NAVYA SRI	J. Navya Sri
49	20UP5A0407	KOLA CHETHANA	K. Chethana
50	20UP5A0408	KOTTHUR DEVI	K. Devi
51	20UP5A0409	MUPPANENI SOWMIKA	M. Sowmika

CO-ORDINATOR

HOD

Head of the Department  
**Electronics and Computer Communication Engineering**  
 Vignans Institute of Management & Technology For Women  
 Kondepur (V), Ghatkesar (M), Medchal-Malkajgiri (DL)-501301



PRINCIPAL  
 Vignans Institute of Management & Technology For Women  
 Kondepur(V), Ghatkesar(M), Medchal-Malkajgiri(DL)-501301  
 Telangana State



Vignan's Institute Of Management and Technology For Women

III B.Tech II sem Students List-2021-22

Branch :ECE-B



S. No	Hall Ticket No	Student Name	sign
1	19UPIA0443	ANNU PRAGATHI	Annupragathi
2	19UPIA0444	ANUMOJU KAVYA	Ab
3	19UPIA0446	BANALA SNITHIKA	B. Snithika
4	19UPIA0447	BHIMAVARAPU SIVA NAGA SAI SARANYA	Sarany
5	19UPIA0448	BOGALA ANUSHA	Anusha
6	19UPIA0449	BOKKA HARSHITHA	Ab
7	19UPIA0450	BOKKA VARSHITHA	Varshitha
8	19UPIA0451	BOLLEPALLY JASHANVI	Jashanvi
9	19UPIA0452	CHIMATA MADHAVI	Madhavi
10	19UPIA0453	DASI VENKATA SAHITHAYA	Sahithaya
11	19UPIA0454	DUGYALA VAISHNAVI	Vaishnavi
12	19UPIA0455	G.SHIRISHA	Shirisha
13	19UPIA0456	GABALE NISHITHA	Nishitha
14	19UPIA0457	GOURISHETTI HARSHA VARDHINI	Harsha
15	19UPIA0458	GUMAMALA SNEHA REDDY	Sneha
16	19UPIA0459	HALDODDI DIVYA	Divya
17	19UPIA0460	JANJIRALA ANUSHA	Anusha
18	19UPIA0461	KARKURI SOWMYA	Sowmya
19	19UPIA0462	KALYANAM MOUNIKA	Mounika
20	19UPIA0463	KOMMINENI JASMITHA	Jasmitha
21	19UPIA0464	KONDERU SRAVYA	K. Sravya
22	19UPIA0465	LAKAMGARI PRASANNA LAXMI REDDY	Prasanna
23	19UPIA0466	GADDAM LIKHITHA	Likhitha
24	19UPIA0467	LIMBURE SANTHOSHI	Santhoshi
25	19UPIA0468	MALGIREDDY YOGITHA REDDY	M. Yogitha
26	19UPIA0469	MARVALA DEEPIKA	Deepika
27	19UPIA0470	MEDA BHUVANESWARI	Bhuvan
28	19UPIA0471	PADAKULA UMA	P. Uma
29	19UPIA0472	RAMIDI DEEKSHITHA	Deekshitha
30	19UPIA0473	RAVULA HIRANMAI	Hiranmai
31	19UPIA0474	SHANIGALA CHANDANA	S. Chandana
32	19UPIA0475	MORAPALLY SIRI CHANDANA REDDY	Siri Chandana
33	19UPIA0476	SUROJU SRIVAISHNAVI	Suraj
34	19UPIA0477	TELUKUNTLA SREYA REDDY	Sreya
35	19UPIA0478	THAMATAM AKSHITHA	Akshitha
36	19UPIA0479	TURPU SHRAVANI	T. Shrug
37	19UPIA0480	VANGETI BANNY	AB
38	19UPIA0481	VENNAMANENI ANOUSHIKA	Anoushika
39	19UPIA0482	YEDULLA NAGALAXMI	Nagalaxmi
40	20UP5A0410	NAGARAM ANUSHA	Anusha
41	20UP5A0411	NAKKA YAMINI	Yamini



PRINCIPAL  
Vignan's Institute of Management & Technology For Women  
Kondapur(V),Ghatkesar(M),Medchal-Malkajgiri(DI)-501301  
Telangana State

42	20UP5A0412	NATTUVA BHARGAVI	<i>Bhargavi</i>
43	20UP5A0413	PALASA CHANDANA	<i>P. Chandana</i>
44	20UP5A0414	SANKURI SRAVANI	<i>S. Sravani</i>
45	20UP5A0415	TANUSHA	<i>T. Anusha</i>
46	20UP5A0416	VADDABOINA NAMRATHA	<i>V. Namratha</i>
47	20UP5A0417	VADLA SHIVANI	<i>A. Shivani</i>
48	20UP5A0418	VINDHYA DARSHINI	<i>V. Darshini</i>
49	20UP5A0419	YAMJALA SHAMILI	<i>Y. Shamil</i>

  
CO-ORDINATOR

  
HOD  
Head of the Department  
Electronics and Communication Engineering  
Vignesh's Institute of Management & Technology For Women  
Kondapur (V), Ghatekasa (M), Medchal-Malkajgiri (Dist.)-501301



  
PRINCIPAL  
Vignesh's Institute of Management & Technology For Women  
Kondapur(V), Ghatekasa(M), Medchal-Malkajgiri(Dist.)-501301  
Telangana State

## REPORT ON INDUSTRIAL VISIT TO ELEGANT EMBEDDED SOLUTIONS

D:30-04-2022,

TO  
The H.O.D

Department of ECE,  
VMTW, HYDERABAD.

Sub: Visit Report on one-day industrial visit to **ELEGANT EMBEDDED SOLUTIONS**

Respected SIR,

The visit was organized with prior permission from **ELEGANT EMBEDDED SOLUTIONS**, up on receiving the letter of permission **ELEGANT EMBEDDED SOLUTIONS**, 100 students with four faculty members myself Mr.SUNIL KUMAR and Mr.ASHOK ,Mr.KARTIK went on an industrial visit to the **ELEGANT EMBEDDED SOLUTIONS** on 28-04-22. We visited all the major facilities and infrastructure of **ELEGANT EMBEDDED SOLUTIONS**. I am sure that this visit will help the students in their future Professional life and bring a positive change in their thinking and practical behavior regarding Education and especially Engineering.

We reached **ELEGANT EMBEDDED SOLUTIONS** at around 9.30 am and after several security checks and administrative formalities, we were taken to a central building.

### The following technical details were given during the visit

- Home Monitoring And Alerts For The Blind PEOPLE

This project is to help the Sighted Challenged to be able to navigate and be alerted to open doors, windows status of their home and surroundings. With the Walabot talking to the Raspberry Pi



  
**PRINCIPAL**  
Vignans Institute of Management & Technology For Women  
Konjeeper(V), Ghatkesar(M), Medchal-Malkajgiri(T),  
Telangana State

The students had an opportunity of visiting main sections of to ELEGANT EMBEDDED SOLUTIONS,AND THEY WERE INTERACTED WITH THE MD OF THE COMPANY AND THEY HAVE TAKEN SOME SUGGESTIONS.

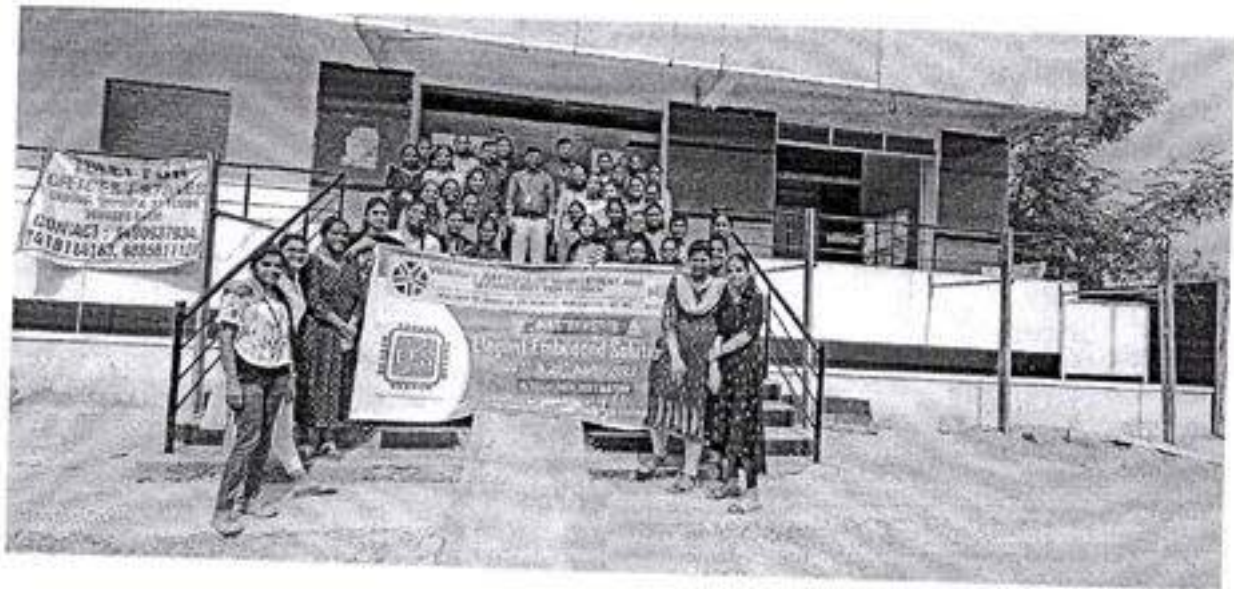

### • Attendance Tracking using RFID

- The project presented in this paper is designed to use a single board computer – Raspberry Pi . On powering ON the RFID reader becomes active and reads RFID UHF tags within a range of one to twelve meters Every card contains a unique number that identifies a student or any other employee of the institution. Every log of attendance is identified using the data of the real time clock. The software program stored in RPi compares the read number with similar data stored in database. If a match is found it checks whether it is the right time, day and venue the student wishes to enter and if found true the green led blinks ratifying the marking of attendance and recording the attendance to the database. Otherwise the red led blinks and a message is shown in the LCD display indicating denial of service. The push button is used to manually reset the system in the event of any error. The program checks for late arrivals and automatically denies recording of attendance. However, for valid reasons which governed and overruled by the lecturer, the system allows to enter attendance using the membrane keypad.
- Other facilities included in the software program are to send SMS message showing the percentage of absence and a reminder of the scheduled classes. In the event of a



PRINCIPAL  
Vigna's Institute of Management & Technology For Women  
Kondapur(V),Ghatbassar(M),Medchal-Malkajgiri(Dt)-50  
Telangana State



and the Amazon Alexa, that enables the hard of sight to be able to be even more aware of their surroundings.

This project is going to be an evolving animal as I go because I am trying to integrate many different technologies into one product. Integrating the Raspi with walabot is pretty straight forward as is the Alexa .



- LED Display Using Embedded System

This project comprises a circular display of a string of LEDs. Using a high speed motor and some mechanical assembly, LED strings mounted on a printed circuit board are duly interfaced to a microcontroller. An appropriate program while executed drives a pair of single line LEDs in space multiplexing mode. This displays some message and or a clock timing taking advantage of persistence of vision of the human eye. Without the single line of LEDs in space multiplexing mode, if one would have to display a message, a number of LEDs as high as around 525 would have been used. Here the project uses only 8 LEDs. Thus material count, hardware requirement, brings the overall cost to a very affordable price. The synchronization is being implemented through software.



  
PRINCIPAL  
Vignana's Institute of Management & Technology For Women  
Hyderabad (V), Ghatkesar (M), Medchal-Malgajigiri (D)-501301  
Telangana State

workshop or seminar, the system can be set with details like date, time and venue. The workshop can be associated to groups where the system allows marking of attendance only for students or lecturers of the assigned group.



*Rashmi*  
PRINCIPAL  
Vignan's Institute of Management & Technology For Women  
Kondapur(V), Ghelakoor(M), Medchal - Malkajgiri(DR) - 501 501  
Telangana State



- STUDENTS LEARNED ABOUT THREE PROJECTS CLEARLY AND THAT PROJECT WILL HELPFUL FOR THEIR MINI PROJECTS TO IMPLEMENT THAT PROJECTS

*J*  
**J. SUNIL KUMAR**

Associate Professor, ECE



*Principals*  
**PRINCIPAL**  
 Vinod's Institute of Management & Technology For Women  
 Kondapur(V), Ghuthesar(M), Medchal-Malkajgiri(DI),  
 Telangana State



**DEPARTMENT OF ELECTRONICS AND COMMUNICATION ENGINEERING**

VMTW/ECE/SEM/CIR/2019-20/2/1

Date: 04-02-2020

**CIRCULAR**

This is to inform all the II B. Tech ECE students that there will be a Seminar on entitled "CONVERSION TECHNIQUES OF OPTICAL SIGNALS" in association with **Elegant Embedded Solutions Pvt. Ltd, Hyderabad**, on **08-02-2020**, by **Mr. K. Jagdeswar Reddy** at ECE B Block Seminar Hall.

All students are invited to take part in this Seminar. The participating students will be honored with certificates of participation. During the seminar you will be encouraged to interact with the speaker and the other participants through the case study discussions.

HOD

Copy to:

The Principal, for kind information

IQAC

Dept. File

Circular to II ECE Class Room



PRINCIPAL

Vignans Institute of Management & Technology For Women  
Kondapur(V), Ghatkesar(M), Medchal-Malkajgiri(D)-501301  
Telangana State

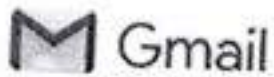

<info@elegantembedded.com>

## Regarding work shop approval

<info@elegantembedded.com>

04, February, 2019 at 11:02 AM

To: Dept. of ECE VMTW <ece@vmtw.iit>

Sir/Madam,

Sub: approved for organizing seminar

Hence further enhancement of students knowledge we have approved the organization to conduct a one day seminar on "Conversion Techniques of optical Signals".

With Regards,  
Mr.K.Jagdeswar Reddy  
Elegant Embedded Solutions Pvt Ltd,  
9885784340, 9396671541,  
[www.elegantembedded.com](http://www.elegantembedded.com)



  
PRINCIPAL  
Vignen's Institute of Management & Technology For Women  
Kondapur(V), Ghatekar(M), Medchal-Market(D)-501301  
Telangana State

Request to conduct a seminar in VMTW college

Dept. of ECE VMTW <ece@vmtw.in>

To: <info@elegantembedded.com>

Mon Feb, 3rd, 2020 at 01:02 PM

Respected sir,

I am Vijaykumar Rewnath Urkude, HOD, Dept of ECE, Vignan's Institute Of Management And Technology For Women, Ghatkesar, Hyderabad, Telangana. We are planning to conduct a one day seminar on "Conversion Techniques of optical Signals" on 08<sup>th</sup> February 2020 to enhance the knowledge of the students. I request to send approval for conducting seminar.

Thanking you

Thanks Regards  
Vijaykumar Rewnath Urkude  
Assoc. Prof & HOD,  
Dept. of ECE, VMTW  
Contact: 92937 93986



*[Handwritten Signature]*  
PRINCIPAL  
Vignan's Institute Of Management & Technology For Women



Vignan's Institute Of Management and Technology For Women

Seminar on "Conversion Techniques of optical Signals"

II B.Tech II sem Students List-2019-20

Branch :ECE-A



S. No	Hall Ticket No	Student Name	Sign of the student 08/02/20
1	18UPIA0401	ADDANKI DHARANI	A. Dharsani
2	18UPIA0402	ADUSUMILLI SRILASYA	A. S.
3	18UPIA0403	ARROJU VAISHNAVI	A. Vaishnavi
4	18UPIA0404	BANDARI MOUNIKA	B. Mounika
5	18UPIA0405	BATTULA SANGEETHA	B. Sangeetha
6	18UPIA0406	CHINTAKUNTA RASAGNA	C. R.
7	18UPIA0407	DAMMANNAPETA SOUJANYA	Soujanya
8	18UPIA0408	DESHAM SRIVANI	D. Srivani
9	18UPIA0409	DIGAJARLA SNEHITHA	D. S.
10	18UPIA0410	GAMPALA MADHURI	Madhuri
11	18UPIA0412	GANDHE AKANKSHA	G. Akanksha
12	18UPIA0413	GANNA KAVYA	G. Kavya
13	18UPIA0414	GATTU MOUNIKA	G. M.
14	18UPIA0415	GIRINENI DIVYA	D. Divya
15	18UPIA0417	GUNTUPALLI MIDHUNA	M. Midhuna
16	18UPIA0418	GURUGUBELLI SUSHMA	S. S.
17	18UPIA0419	JAGINI SHARANYA	Sharanya
18	18UPIA0420	JANAGAMA SRIVIDHYA	S. Srividhya
19	18UPIA0421	JOGIRAJU AKSHARA	J. Akshara
20	18UPIA0422	JONNALAGADDA DEEPTHI	Deepti
21	18UPIA0423	K HARIPRIYA	K. Haripriya
22	18UPIA0424	KANCHARLA SRUTHI	Sruthi
23	18UPIA0425	KONAMUTLA JHANSI	J. Jhansi
24	18UPIA0426	KOTA LIKHITHA	L. Likhitha
25	18UPIA0427	KOTHA SWATHI	S. Swathi
26	18UPIA0428	KOTLA SONY	S. Sony
27	18UPIA0429	KOTTAM AKHILA	A. Akhila
28	18UPIA0430	KUNTA DEEPIKA	K. Deepika
29	18UPIA0431	LADALLA PAVANI	P. Pavani
30	18UPIA0432	MADDI SRIVIDYA	S. Srividhya
31	18UPIA0433	MALAMANTI MOUNIKA	M. Mounika
32	18UPIA0434	MAREPALLY ADITI SAI	A. Sai
33	18UPIA0435	MITTA AKSHITHA	M. Akshitha
34	18UPIA0436	MOROJU KUSUMA	K. Kusuma
35	18UPIA0437	MOTAMARRI MEGHANA	M. Meghana
36	18UPIA0438	N GAYATHRI	N. Gayathri
37	18UPIA0439	N RUPARANI	N. Ruparani
38	18UPIA0440	NACHU SHIVANI	S. Shivani
39	18UPIA0442	PEDDI AISHWARYA	A. Aishwarya
40	18UPIA0443	PULUSANI VARSHITHA	P. Varshitha



PRINCIPAL  
Vignan's Institute of Management & Technology For Women  
Kandapur(V),Ghatkesar(M),Medchal-Malkajgiri(D),401001  
Telangana State

41	18UP1A0444	REDDYGARI JAHNAVI REDDY	J. A. R.
42	18UP1A0445	SAMALA POOJA	P. Poja.
43	18UP1A0446	SHAIK ZEENATH	Zeenath
44	18UP1A0447	SINGIRIKONDA AISHWARYA	A. S.
45	18UP1A0448	SUKKA SHARANYA	Sharanya
46	18UP1A0449	SUNKARABOINA AMOOL SIRI	S. Amool Siri
47	18UP1A0450	TANGUTURI NIHARIKA	N. H.
48	18UP1A0451	VEERAMALLA MANASA	M. M.
49	18UP1A0452	VUPPUGANDLA SREEJA	V. Sreeja
50	18UP1A0453	YELLOJU SRAVANI	S. Sravani
51	19UP5A0401	ABRABOINA SAIKUMARI	S. S.
52	19UP5A0402	ADEPU SHIVANI	Shivani
53	19UP5A0403	BANDI JHANSI	Jhansi
54	19UP5A0404	BATHINI NIVEDITHA	N. N.
55	19UP5A0405	BODDIREDDY RAVALI	B. Raval
56	19UP5A0406	DONIKALA AKHILA	D. Akhila
57	19UP5A0407	GANDHARI SHAILAJA	G. S.

*[Signature]*  
CO ORDINATOR

*[Signature]*  
ECE, HOD



*[Signature]*  
PRINCIPAL  
Women's Institute of Management & Technology For Women  
Chittoor(V), Ghattisear(M), Madhavipet, Pin-517101  
Talnadra, Dist.





Vignan's Institute Of Management and Technology For Women

Seminar on "Conversion Techniques of optical Signals"



II B.Tech II sem Students List-2019-20

Branch :ECE-B

S. No	Hall Ticket No	Student Name	Sign of the student 08/02/20
1	18UPIA0454	ARSHIA JABEEN	Jabeen
2	18UPIA0455	ATLURU SINDHUJA	Sindhuja
3	18UPIA0456	B SOUMYA	B. Soumya
4	18UPIA0457	MOTUPALLI BHAVANA SAI PRIYA	Motupalli
5	18UPIA0458	BODDIREDDY SAI ASHRITHA	Boddireddy
6	18UPIA0459	B ABHIGNA	Abhigna
7	18UPIA0460	BOGGULA VENKATA KRISHNA	Venkata
8	18UPIA0461	BORRA LIKITHA	Likitha
9	18UPIA0462	C KAVYA SREE	C. Kavya Sree
10	18UPIA0463	CHALASANI SRI SAI BHUVANESWARI	Chalasanani
11	18UPIA0464	CHALLA TEJASWINI	Tejaswini
12	18UPIA0465	GADUSU NAVYA	Gadusu
13	18UPIA0466	GUMMADEELA LAKSHMI PRASANNA	Gummadeela
14	18UPIA0467	GURRAM SRAVANTHI	Sravanthi
15	18UPIA0468	JAKKA DEEPTHI	Deepti
16	18UPIA0469	JAKKA KEERTHI	Keerti
17	18UPIA0471	KANDADI POOJA	K. Pooja
18	18UPIA0472	KARI DIVYA SRI SAI DURGA	Kari Divya
19	18UPIA0473	KODALI RUPA	Kodali
20	18UPIA0474	KOLA SNIGDHA	Kola
21	18UPIA0475	KOPPULA BHAVANA	Koppula
22	18UPIA0476	KURREMULA SAI SOWJANNYA	Kurremula
23	18UPIA0477	MALKEYAGARU SATHWIKI REDDY	Malkeyagaru
24	18UPIA0478	MANDALA SHRESTA	Mandala
25	18UPIA0479	MARAMPALLY APOORVA	Marampally
26	18UPIA0480	MOMULA VASANTHA LAXMI	Momula
27	18UPIA0481	NAGA SAI LAKSHMI	Naga
28	18UPIA0482	NANDYALA VARSHITHA	Nandyala
29	18UPIA0483	PODURI MEHER SESHASREE	Poduri
30	18UPIA0484	PESARU SHIVANI	P. Shivani
31	18UPIA0486	VIJAYA VYSHNAVI	Vijaya
32	18UPIA0487	PAPPULA VARSHITHA	Pappula
33	18UPIA0488	PEDDI RASHMITHA	Peddi
34	18UPIA0489	PEDDIREDDY PRAVALIKA	Peddireddy
35	18UPIA0490	PENDYALA BHOOMIKA	Pendyala
36	18UPIA0491	POCHAMPALLI HARINI	Pochampalli



PRINCIPAL

Vignan's Institute of Management & Technology For Women  
sondepur(V),Chalkeer(M),Medchal-Malkajgiri(DI)-501307  
Telangana State

37	18UP1A0492	PODDUTURI ANVITHA	Anvitha.
38	18UP1A0493	POTHUGANTI MADHUNITHA	madhu.
39	18UP1A0494	PULLURU SRAVANI	P. Sravani
40	18UP1A0495	PYATA PRANANJALI REDDY	Pra
41	18UP1A0496	SANTI SREEJA REDDY	santa.
42	18UP1A0497	SARANGA NAVYA SRI	S. Navya Sri
43	18UP1A0498	SAVIRIGAM SRAVYA	AB
44	18UP1A0499	SUDHAGONI SINDHU	Sundhan
45	18UP1A04A0	TENKASALA SHRUTHI MADHURI	madhuri
46	18UP1A04A1	VEERAMREDDY SATVIKA	AB
47	18UP1A04A2	VUYYALA SREEJA	sreeja.
48	18UP1A04A3	YERRA SUSHMITHA	sushma
49	19UP5A0408	K RENUKA	Renu.
50	19UP5A0409	NIMMA JHANSI	Jhansi
51	19UP5A0410	NURCHU SHIRISHA	shirisha.
52	19UP5A0411	NUTENKI SINDHU	AB
53	19UP5A0412	POOSALA KEERTHY	keerthi
54	19UP5A0413	S. AKHILA	S. Akhila
55	19UP5A0414	VORUGANTI AKANKASHA	AB
56	19UP5A0406	DONIKALA AKHILA	Akhi
57	19UP5A0407	GANDHARI SHAILAJA	Shailaja

ch. Hanu  
CO ORDINATOR

R. Srinivas  
ECE, HOD

Head of the Department  
Electronic and Communication Engineering  
Vignana's Institute of Management & Technology For Women  
Kondapur (V), Ghatkesar (M), Medchal-Malkajgiri (Dt)-501301



V. Srinivas  
PRINCIPAL

Vignana's Institute of Management & Technology For Women  
Kondapur(V), Ghatkesar(M), Medchal-Malkajgiri(Dt)-501301  
Telangana State



VIGNAN'S INSTITUTE OF MANAGEMENT AND  
TECHNOLOGY FOR WOMEN

Kondapur (V), Ghatkesar (M), Medchal. Dist – 501 301.



DEPARTMENT OF ELECTRONICS AND COMMUNICATION ENGINEERING

Date: 10-02-2020

Conclusion report on “Conversion Techniques of optical Signals”

**Sub:** conclusion Report of “Conversion Techniques of optical Signals”

Conducted on 08-02-2020—reg.

The seminar was aimed to provide knowledge about Basics of optical Signals.

Mr.K.Jagdeswar Reddy,Elegant Embedded systems PVT LTD,HYD, executed 1-days seminar on “Conversion Techniques of optical Signals”. After attending this seminar students have expressed about their capability using Conversion Techniques of optical Signals and applications in any Electronics Project. This seminar will be helpful for students for circuit development of their final year project. Total 88 students have participated in this Seminar. The Seminar was an informative and interesting. All the students of ECE had a practical exposure about Conversion Techniques of optical Signals.

On behalf of the students I request you to arrange more seminars for students to improve the knowledge of students and enhance the career opportunities

Mrs. Swathi Gangula

Assistant Professor, ECE.

VMTW ,Ghatkesar,HYD.



PRINCIPAL

Vignan's Institute of Management & Technology For Women  
Kondapur(V),Ghatkesar(M),Medchal-Makepalli(Dt)-501301  
Telangana State



# VIGNAN'S INSTITUTE OF MANAGEMENT AND TECHNOLOGY FOR WOMEN

Sponsored by Lavu Educational Society, Approved by AICTE, New Delhi & Affiliated to JNTUH, Hyderabad.  
Kondapur (V), Ghatkesar (M), Medchal - Malkajgiri (D) - 501 301 TS INDIA  
Phone: +08615 200008/07/08 Email: info@vmtw.in

## DEPARTMENT OF ELECTRONICS AND COMMUNICATION ENGINEERING

VMTW/ECE/SEM/CIR/2018-19/2/1

Date: 28-02-2019

### CIRCULAR

This is to inform all the II B. Tech ECE students that there will be a Seminar on entitled "BASICS OF SIGNALS AND ANALYSIS OF SYSTEM THROUGH MATLAB" in association with Elegant Embedded Solutions Pvt. Ltd Hyderabad, on **02-03-2019**, by Mr. K. Jagdeswar Reddy, at ECE B Block Seminar Hall.

All students are invited to take part in this Seminar. The participating students will be honored with certificates of participation. During the Seminar you will be encouraged to interact with the speaker and the other participants through the case study discussions.

HOD

Copy to:

The Principal, for kind information

IQAC

Dept. File

Circular to II ECE Class Room



PRINCIPAL  
Vignani's Institute of Management & Technology For Women  
Kondapur (V), Ghatkesar (M), Medchal - Malkajgiri (D) - 501301  
Telangana State



Vignan's Institute Of Management and Technology For Women  
Seminar on "Basics of signals and analysis of systems through MATLAB"

II B.Tech II sem Students List-2018-19  
Branch :ECE-A

S.No	Hall Ticket No	Student Name	Sign of the student 02/03/19
1	17UPIA0401	ANUMOJU SRAVANI	Sravani
2	17UPIA0402	ATUKURI VIGNESHWARI	Vigneshwari
3	17UPIA0403	BABIREDDY NAINIKA REDDY	Nainika
4	17UPIA0404	BASHETTI PRAVALIKA	Pravalika
5	17UPIA0405	BERE YASHASWINI	Yashaswini
6	17UPIA0406	BONTHU RAMYA	Ramy
7	17UPIA0407	CH DHARANI	Ch. Dhavani
8	17UPIA0408	CHEEMALA MOUNIKA	Mounika
9	17UPIA0409	CHILUKA KAVYA SRI	Kavya
10	17UPIA0410	CHINTAMKAR SAIPRIYA	Saipriya
11	17UPIA0411	CHINTHA BHAVITHA	Bhavitha
12	17UPIA0412	CHOKKAM DIVYA	Divya
13	17UPIA0413	DHARNABOINA ARCHANA	Archana
14	17UPIA0414	ELLENDULA VAISHANAVI	Shreelha
15	17UPIA0415	GOURLA SWETHA	Swetha
16	17UPIA0416	JAKKULA BHUVI AKARSHA	Akarsha
17	17UPIA0417	K AKANKSHA REDDY	k. Akanksha
18	17UPIA0418	KALYANKAR HARI PRIYA	Hari priya
19	17UPIA0419	KODURU SOWMYA	Sowmya
20	17UPIA0420	KULSUM KEKHAM NAYYAR	Kulsum
21	17UPIA0421	KUNCHUPU JAHNAVI	Jahnavi
22	17UPIA0422	M SRAVANTHI	Sreeta
23	17UPIA0423	M SREEJA	Sreeja
24	17UPIA0424	MAHESHWARAM PRAVALIKA	Pravalika
25	17UPIA0425	MANISHA MUTTAVARAPU	Manisha
26	17UPIA0426	MODUGU MANISHA	Manisha
27	17UPIA0427	NAGA SAI BHAVANI GOTTIUMUKKULA	Bhavani
28	17UPIA0428	NALLAM ANJANA SRIVENI	Anjana
29	17UPIA0429	NANDIGAMA NAVYA	Navya
30	17UPIA0430	P NANDINI	P. Nandini
31	17UPIA0431	PABBATHI PRIYANKA	Priyanka
32	17UPIA0432	PAGALA RAMYA	Ramy
33	17UPIA0433	PALADUGU SANDHYA	Sandhya
34	17UPIA0434	PANDLA SARAYU	Sarayu
35	17UPIA0435	PASHAM SHIVANI REDDY	Shivani
36	17UPIA0436	PATURI MANUSHA	Manusha
37	17UPIA0437	POLAGANI BHARGAVI	Bhargavi
38	17UPIA0438	POLICE PREETHI	P. Preethi
39	17UPIA0439	POTALA SRAVYASEE	Sravysa
40	17UPIA0440	POTLAPALLI CHANDRAN	Chandran



PRINCIPAL  
Vignan's Institute of Management & Technology For Women  
Kondapur(V), Ghatkesar(M), Medchal-Malkajgiri(DR)-501301  
Telangana State

41	17UPIA0442	PUNDRU KEERTHANA	<i>Pundru</i>
42	17UPIA0443	PUSULLURI VASANTHI REDDY	
43	17UPIA0444	R SUBHIKSHA	<i>Subhiksha</i>
44	17UPIA0445	RACHABATTULA PRANAVA	<i>R. Subhiksha</i>
45	17UPIA0446	RAMADASU SUSHMITHA	<i>Sushmitha</i>
46	17UPIA0447	S TEJA	<i>Teja</i>
47	17UPIA0448	SUNKARI SOUMYA	<i>SU</i>
48	17UPIA0449	TUNGATURTI YASASWI SOWMYA	<i>Sowmya</i>
49	17UPIA0450	UDUTHALA SHIVANI	<i>Shivani</i>
50	17UPIA0451	VAKITI SHIRISHA	<i>Shirisha</i>
51	17UPIA0452	VEMIREDDY RAMYASREE	<i>V. Ramyasree</i>

*[Signature]*  
CO ORDINATOR

*[Signature]*  
ECE, HOD

Vignans Institute of Management & Technology For Women  
Kondapur (V), Ghatkesar (M), Medchal-Malkajgiri (Dt)-501301  
Telangana State



*[Signature]*  
PRINCIPAL  
Vignans Institute of Management & Technology For Women  
Kondapur (V), Ghatkesar (M), Medchal-Malkajgiri (Dt)-501301  
Telangana State



Vignana's Institute Of Management and Technology For Women  
Seminar on "Basics of signals and analysis of systems through MATLAB"

II B.Tech II sem Students List-2018-19

Branch :ECE-B

S. No	Hall Ticket No	Student Name	Sign of the student-02/03/19
1	17UPIA0454	ANKAPURAM VARSHA	Varsha
2	17UPIA0455	AYESHA NAFEEZ	Ash
3	17UPIA0456	BADDAM SANGEETHA	Se
4	17UPIA0457	BATHINI UDHAYASRI	Sri
5	17UPIA0458	BEERAVALLI GEETHA CHANDANA	Geetha
6	17UPIA0459	CHAMA HARINI	Harini
7	17UPIA0460	CHILUKURI ANJALI	Anjali
8	17UPIA0461	CHITYALA HIMAJA	Himaja
9	17UPIA0462	DODDA NIHARIKA	Niharika
10	17UPIA0463	GOTTUMUKULA PRANITHA	Pranitha
11	17UPIA0464	GUDIPATHI PRANITHA	Pranitha
12	17UPIA0465	GURRALA VENKATAKRISHNAVENI	Venka
13	17UPIA0466	KESARA SUCHARITHA	SUCHARITHA
14	17UPIA0467	KOMATIREDDY JHANSI	Jhansi
15	17UPIA0468	KONDA SANJANA	SANJANA
16	17UPIA0469	KONDURU HARSHITHA	harshi
17	17UPIA0470	KUDIDHI SUSHMA	Sushma
18	17UPIA0471	KUKKADAPU PRAVALLIKA	pravallika
19	17UPIA0472	MADDIRALA VASAVI	Vasavi
20	17UPIA0473	MAHENDRAKAR RACHANA	Rachana
21	17UPIA0474	MAMILLAPALLY MOUNIKA	MOUNIKA
22	17UPIA0475	MUKUNDU MOUNIKA	Mounika
23	17UPIA0476	MUSHNAM REVATHI	Revathi
24	17UPIA0477	NACHU CHAITRA	chaitra
25	17UPIA0478	PAILLA SNEHA	Sneha
26	17UPIA0479	PANJALA HIMA SANTOSHINI	Hima
27	17UPIA0480	PATLOLLA AKHILA	Akhila
28	17UPIA0481	PEDDAMAGARI SWATHI	Swathi
29	17UPIA0482	POLNEEDI KAVYA SRI	Sri
30	17UPIA0483	PREETHIKA	Preethika
31	17UPIA0484	PUCHAKAYALA SATWIKA	Satwika
32	17UPIA0485	PULLURI MADHURI	Madhuri
33	17UPIA0486	R INDUMANI	Induman
34	17UPIA0487	R VANI	vani
35	17UPIA0488	RAMANAKOL PRIYANKA	Priyanka
36	17UPIA0489	SHYAM REDDY VARSHA	Varsha
37	17UPIA0490	SINGIDI PUJITHA	Pujitha
38	17UPIA0491	SIRAPANGI KEERTHY EVANGELINE	Keerthy
39	17UPIA0492	SOORISHI ELY SUKEERTHI	Sukeerthy



PRINCIPAL  
Vignana's Institute of Management & Technology For Women  
Kondapur(V), Ghatkesar(M), Medchal-Malkajgiri(DI)-501301  
Telangana State

40	17UP1A0493	SOUNDHA ANUSHA	<i>Soundha</i>
41	17UP1A0494	SRIKAKOLLAPU AMRUTHA VARSHINI	<i>Varsha</i>
42	17UP1A0495	SUKKA SAHITHI	<i>Sahithi</i>
43	17UP1A0496	TELU NIKITHA	<i>Nikitha</i>
44	17UP1A0497	THAGIRA SAI PRIYA	<i>Sai Priya</i>
45	17UP1A0498	UPPULURI SHYAMALA SESHADRI	<i>Seshadri</i>
46	17UP1A0499	VAVILIKOLANU CHANDANA	<i>Chandana</i>
47	17UP1A04A0	VEERAMALLA PRATHYUSHA	<i>Prathyusha</i>
48	17UP1A04A1	VELMA VYSHNAVI REDDY	<i>Vyshnavi</i>
49	18UP5A0401	BUSHABOINA SHRAVYA	<i>Shravya</i>
50	18UP5A0402	HAFSA SUBHI	<i>Subhi</i>
51	18UP5A0403	KORNI MADHAVI	<i>Madhavi</i>

CO ORDINATOR

*Ch. Praveen*

ECE, HOD

*R. Ramesh*



*R. Ramesh*  
 PRINCIPAL  
 's Institute of Management & Technology For Women  
 Kondapur(V), Ghatkesar(M), Medchal-Malkajgiri(Dt)-501301  
 Telangana State





## DEPARTMENT OF ELECTRONICS AND COMMUNICATION ENGINEERING

Date: 08-03-2019

### Conclusion report on “Basics of signals and analysis of systems through MATLAB”

**Sub:** conclusion Report of “Basics of signals and analysis of systems through MATLAB”

Conducted on 02-03-2019 —reg.

The seminar was aimed to provide knowledge about Basics of signals and analysis of systems through MATLAB

Mr. K. Jagadeswar Reddy, Basics of Signals and Analysis of Systems through MATLAB, HYD, executed 1-days seminar on “Application Basics of signals and analysis of systems through MATLAB” and applications. After attending this seminar students have expressed about their capability of Designing signals and analysis of systems through MATLAB and applications in any Electronics Project. This seminar will be helpful for students for circuit development of their final year project. Total 98 students have participated in this Seminar. The Seminar was an informative and interesting. All the students of ECE had a practical exposure about signals and analysis of systems through MATLAB

On behalf of the students I request you to arrange more seminars for students to improve the knowledge of students and enhance the career opportunities.



PRINCIPAL

Vignan's Institute of Management & Technology For Women  
Kondapur (V), Ghatkesar (M), Medchal - Malkajgiri (D) - 501301  
Telangana State

Mr. Sunil Kumar J

Associate Professor, ECE.

VMTW, Ghatkesar, HYD.



VMTW/CRT/CIR/2017-18/1/01

Date: 06-09-2017

**CIRCULAR**

All the HODs and Placement Coordinators are here by requested to inform III- B.Tech students that "**Campus Recruitment Training on Front End Technologies**" will be conducted in our college starting from 11-09-17 to 16-09-17 for all third year CSE students.

Contact T&P Cell for further information.

Copy to:

1. CEO, for his kind information.
2. All the Deans.
3. The HOD (CSE / ECE / EEE / IT / AIML / BSH)
4. IQAC.
5. Admin Office.
6. All Notice Boards.
7. Circulate to all Class Rooms.
8. File

PRINCIPAL

PRINCIPAL

Vignan's Institute of Management & Technology For Women  
Kondapur (V), Ghatkesar (M), Medchal-Malkajgiri (Dt)-501301  
Telangana State



PRINCIPAL

Vignan's Institute of Management & Technology For Women  
Kondapur (V), Ghatkesar (M), Medchal-Malkajgiri (Dt)-501301  
Telangana State



Date: 20-09-2017.

## Training and placement cell

**Name of the Programme:** Campus Recruitment Training

**Syllabus:** HTML, CSS, Java Script, React JS, Angular JS.

**Objective:** To train the students in areas such as to create a user-friendly and visually appealing interface for websites, applications, and soft skills to make them ready for placements.

**Name of the Organization:** CodeMax IT solutions Pvt. Ltd.

**Dates of the program:** 11-09-2017 to 16-09-2017.

**Number of students attended:** 48

**Resource Person:** Kalyan Srivastav



**Outcome:** Students were trained in Front-end technologies focus on the presentation layer of a website application and making them ready for campus placements.

The undersigned thanked the respective department coordinators for their able support in completing the program successfully.

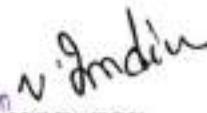

  
PRINCIPAL  
Vignans Institute of Management & Technology For Women  
Kondapur (V), Ghatkesar (M), Medchal-Malkajgiri (D)-501301  
Telangana State

  
HOD-CSE  
Head of The Department  
Computer Science and Engineering  
Vignans Institute of Management & Technology For Women  
Kondapur (V), Ghatkesar (M), Medchal-Malkajgiri (D)-501301  
Telangana State

Name of the Organization: Codemax

Course instructor: Kalyan Srivastav

### Training & Placement Cell

### CRT Program Conducted on Front-end Technologies

#### CSE Attendance Sheet

S.No	Roll No	Student Name	11/09	12/09	13/09	14/09	15/09	16/09
1	15UP1A0552	AKULA VANAJA	P	P	P	P	P	P
2	15UP1A0553	AKUULA PRIYANKKA	P	P	P	P	P	P
3	15UP1A0554	ANANTHULA RAVALI	P	P	P	P	P	P
4	15UP1A0555	ANDAM SIRISHA	P	P	P	P	P	P
5	15UP1A0556	BANDI RASHMITHA	Ab	Ab	Ab	Ab	Ab	Ab
6	15UP1A0557	BAREDDY SRAVANTHI	P	P	P	P	P	P
7	15UP1A0559	BOPPIDI ROOPASRI	P	P	P	P	P	P
8	15UP1A0560	CHANDA VARALAXMI	Ab	Ab	Ab	Ab	Ab	Ab
9	15UP1A0561	CHATHELLI PRANAVI	Ab	Ab	Ab	Ab	Ab	Ab
10	15UP1A0562	CHIRABOINA RAMADEVI	P	P	P	P	P	P
11	15UP1A0563	CHOWDAVARAPU LAKSHMI PRIYA	P	P	P	Ab	Ab	Ab
12	15UP1A0564	DARIPALLI AMANI	P	P	P	P	P	P
13	15UP1A0565	EDUKULLA LIKITHA	P	P	P	P	P	P
14	15UP1A0567	GOPISETTY SAHAJA	P	P	P	P	P	P
15	15UP1A0568	K NAVA JYOTHI	P	P	P	P	P	P
16	15UP1A0569	KANDULA MANMITHA	P	P	P	P	P	P
17	15UP1A0570	KARLA AMULYA	P	P	P	P	P	P
18	15UP1A0571	L SONALI	P	P	P	P	P	P
19	15UP1A0572	MANDADI MOUNIKA	Ab	Ab	Ab	Ab	Ab	Ab
20	15UP1A0573	MARYALA DIKSHITHA	P	P	P	P	P	P
21	15UP1A0574	MENDE KAVYA	P	P	P	P	P	P
22	15UP1A0575	MIRYALA SRI LAKSHMI	P	P	P	P	P	P
23	15UP1A0576	MOOLA VIDYA SRI	P	P	P	P	P	P
24	15UP1A0577	N USHARANI	P	P	P	P	P	P
25	15UP1A0578	NANDINI BANDARU	P	P	P	P	P	P
26	15UP1A0579	NANGUNURI NAVYA SRI	P	P	P	P	P	P
27	15UP1A0580	PENDYALA LASYA PRIYA	P	P	P	P	P	P
28	15UP1A0581	PININTI NIHARIKA REDDY	Ab	Ab	Ab	Ab	Ab	Ab
29	15UP1A0582	PUTTA DEEKSHITHA	Ab	Ab	Ab	Ab	Ab	Ab
30	15UP1A0583	RAMADEVI SEELAM	Ab	Ab	Ab	Ab	Ab	Ab
31	15UP1A0584	RAVALKOLE MANASA	P	P	P	P	P	P
32	15UP1A0585	RAVIRALA HARSHITHA	P	P	P	P	P	P



*AS*  
PRINCIPAL  
Vignani's Institute of Management & Technology For Women  
Kondapur (V), Ghatkesar (M), Medchal-Malkajgiri (DI)-501301  
Telangana State

33	15UP1A0586	RELANGI VIJAYA DURGA	P	P	P	P	P	P
34	15UP1A0587	SAGIREDDY HEVANYA	Ab	Ab	Ab	Ab	Ab	Ab
35	15UP1A0588	SAMALA ANUSHA	P	P	P	P	P	P
36	15UP1A0589	SANTHAPURI VAISHNAVI	Ab	Ab	Ab	Ab	Ab	Ab
37	15UP1A0590	SOMA SHRUTHI	P	P	P	P	P	P
38	15UP1A0591	SUMREDDY ABHINAYA	P	P	P	P	P	P
39	15UP1A0592	SUNKARI SOWMYA REDDY	P	P	P	P	P	P
40	15UP1A0593	TALAPAREDDY SANGHAVI	P	P	P	P	P	P
41	15UP1A0594	THIRMANI BHAVANI	P	P	P	P	P	P
42	15UP1A0595	VEERANALA MANASA	P	P	P	P	P	P
43	15UP1A0596	VELAPATI SOWMYA	Ab	Ab	Ab	Ab	Ab	Ab
44	15UP1A0598	VEMI REDDY LAKSHMI KALYANI	P	P	P	P	P	P
45	15UP1A0599	VODDE DIVYA	P	P	P	P	P	P
46	15UP1A05A1	VOOTUKURY PRAVALLIKA	P	P	P	P	P	P
47	15UP1A05A2	VORUGANTI PRAVALLIKA	P	P	P	P	P	P
48	15UP1A05A3	MAHVEEN ARSHI	P	P	P	P	P	P

*V. Indira*  
HOD-CSE

Head of The Department  
Computer Science and Engineering  
Vignani's Institute of Management & Technology For Women  
Kondapur (V), Ghatkhesar (M), Medchal-Malkajgiri (Dt)  
Telangana State



*A.S.*  
PRINCIPAL  
Vignani's Institute of Management & Technology For Women  
Kondapur (V), Ghatkhesar (M), Medchal-Malkajgiri (Dt)-501301  
Telangana State



# VIGNAN'S INSTITUTE OF MANAGEMENT AND TECHNOLOGY FOR WOMEN

Sponsored by Laxmi Educational Society, Approved by AICTE, New Delhi & Affiliated to JNTUH, Hyderabad.  
Kondapur (V), Ghatkesar (M), Medchal - Malkajgiri (D) - 501 301 TS INDIA  
Phone: +91815 20006/07/08 Email: info@vmtw.in

Date: 17-08-2017

VMTW/ TP/CSE//CIR / 2017-18/ 8

## CIRCULAR

All the HODs and Placement Coordinators are hereby requested to inform III- B.Tech students that "Campus Recruitment Training by TASK" will be conducted in our college starting from 21-08-2017 to 26-08-2017 for all third year CSE students.

Contact T&P Cell for further information.

Copy to:

1. CEO for information,
2. All the Deans,
3. The HOD (CSE / ECE / EEE / IT / AIML / BSH),
4. IQAC,
5. Admin Office,
6. All Notice Boards,
7. Circulate to all Class Rooms,
8. File.



PRINCIPAL

PRINCIPAL

Vignan's Institute of Management & Technology For Women  
Kondapur (V), Ghatkesar (M), Medchal-Malkajgiri (D)  
Telangana State

PRINCIPAL

Vignan's Institute of Management & Technology For Women  
Kondapur (V), Ghatkesar (M), Medchal-Malkajgiri (D)-501301  
Telangana State



# VIGNAN'S INSTITUTE OF MANAGEMENT AND TECHNOLOGY FOR WOMEN

Sponsored by Lawu Educational Society, Approved by AICTE, New Delhi & Affiliated to JNTUH, Hyderabad.

Kondapur (V), Ghatkesar (M), Medchal - Malkajgiri (D) - 501 301 TS INDIA

Phone: +08615 200008/07/08

Email: info@vmtw.in

Date: 29-08-2017

## Training placement cell

### Report on CRT Program Conducted by TASK

**Name of the Program:** Campus Recruitment Training

**Syllabus:** Pre-placement talk, Aptitude tests, Group discussion, Technical Interview, HR Interview, Pre Placement Talk.

**Objective:** To train the students in areas such as quantitative aptitude, verbal aptitude, reading comprehension, fundamentals of programming and soft skills to make them ready for placements.

**Name of the Organization:** TASK

**Course instructor:** G. Naresh

**Dates of the program:** 21-08-2017 to 26-08-2017

**Number of students attended:** 48



**Outcome:** Students were trained in quantitative aptitude, logical reasoning, verbal aptitude, reading comprehension, soft skills, group discussions, interview skills. Resume writing, and email and telephone etiquette, making them ready for campus placements.

The undersigned thanked the respective department coordinators and TASK, for their able support in completing the program successfully.



*G. Naresh*  
PRINCIPAL  
Vignans Institute of Management & Technology For Women  
Kondapur(V), Ghatkesar(M), Medchal-Malkajgiri(D)-501301  
Telangana State

Name of the Organization: TASK

Course instructor: G. Naresh

**Training & Placement Cell**

**CRT Program Conducted by TASK**

CSE Attendance Sheet

S.No	Roll No	Student Name	21/08	22/08	23/08	24/08	25/08	26/08
1	14UP1A0505	B. Meghana	P	P	AB	P	AB	P
2	15UP1A0501	Annavarapu Hima Rajyalakshmi	P	AB	P	P	P	AB
3	15UP1A0502	Basude Preethi	AB	P	AB	P	P	P
4	15UP1A0503	Bayyadugula Praveena	P	P	P	P	P	P
5	15UP1A0504	Beenamohina Tejasvee Yadav	AB	AB	AB	P	P	AB
6	15UP1A0505	Bodika Sandhya Rani	AB	P	P	P	P	P
7	15UP1A0506	Bolloju Ramya Smruthi	P	P	AB	P	P	AB
8	15UP1A0507	Bomma Akhila	P	P	P	P	P	P
9	15UP1A0508	Bonthu Taruna Sri	P	P	AB	P	P	P
10	15UP1A0509	Burugu Tejasri	P	AB	P	P	AB	P
11	15UP1A0510	Chennala Gayatri Yadav	P	P	P	P	P	AB
12	15UP1A0511	Chindam Pranava	P	P	P	AB	P	P
13	15UP1A0512	Chowdarapu Srija	P	P	AB	P	P	AB
14	15UP1A0513	D A Divya	P	P	P	P	P	P
15	15UP1A0514	D Anusha	P	P	P	P	P	AB
16	15UP1A0515	Damuluri Divya	AB	P	AB	P	P	P
17	15UP1A0517	Dendukuru Srirekha	P	AB	P	AB	AB	P
18	15UP1A0518	Dharni Manisha	P	P	P	P	P	P
19	15UP1A0519	G Vaishnavi	AB	P	AB	P	P	P
20	15UP1A0520	Golem Supraja Chinmayee	AB	P	P	P	P	P
21	15UP1A0522	Gullipalli Jahnvi	AB	AB	P	P	P	P
22	15UP1A0523	Gunda Sowmya	P	P	P	AB	P	AB
23	15UP1A0524	Gurdeep Kaur Jandu	P	P	P	AB	P	P
24	15UP1A0525	K Anusha	P	P	P	AB	P	P
25	15UP1A0526	K Shruthi	P	AB	AB	P	P	P
26	15UP1A0528	Kambalapally Mounika	P	P	P	P	P	P
27	15UP1A0529	Kotika Siva Parvathi	P	P	P	P	P	P
28	15UP1A0530	Krishnadhari Sowjanya	AB	P	P	P	P	P
29	15UP1A0532	Manjula Digamber Devkotte	AB	P	P	P	P	P
30	15UP1A0533	Marpu Swetha Reddy	P	P	P	AB	P	P
31	15UP1A0534	Mogula Lakshmi Reddy	P	P	P	P	P	P
32	15UP1A0535	N Nisha Reddy	AB	P	P	P	AB	P



*Naresh*  
PRINCIPAL  
Vignana's Institute of Management & Technology For Women  
Kondapur(V),Ghatkesar(M),Medchal-Malkajgiri(D1)-501301  
Telangana State



33	15UP1A0536	Nakrekanti Prashanthi	P	P	P	P	AB	P
34	15UP1A0537	Nerella Tejaswini	AB	P	P	P	P	AB
35	15UP1A0538	Padmam Krishnaveni	P	P	P	P	P	P
36	15UP1A0539	Panaganti Madhushalini	AB	AB	P	P	P	P
37	15UP1A0540	Potham Jyoshna Devi	P	P	P	P	AB	P
38	15UP1A0541	Pulamoni Pravalika	P	P	P	AB	P	P
39	15UP1A0542	Pulgam Kavya	AB	P	P	P	P	AB
40	15UP1A0544	Sarikonda Pooja	P	P	P	P	P	P
41	15UP1A0545	Sravani Reddy Barlapally	P	P	P	P	P	P
42	15UP1A0546	Sri Rama Vineetha	P	P	P	P	P	P
43	15UP1A0547	Sunkara Saimounika	AB	P	P	P	P	AB
44	15UP1A0548	Suthoju Sneha	P	P	P	P	AB	P
45	15UP1A0549	Swargam Mounika	AB	P	P	P	P	P
46	15UP1A0550	Thoutam Chandana	P	P	P	AB	P	P
47	15UP1A0551	Valaboju Divya Sri	P	AB	P	P	P	P
48	15UP1A0552	Akula Vanaja	P	P	P	P	P	P
49	15UP1A0553	Akuula Priyanka	AB	AB	AB	P	P	P
50	15UP1A0554	Ananthula Ravali	P	P	P	P	P	P
51	15UP1A0555	Andam Sirisha	P	AB	P	P	P	P
52	15UP1A0556	Bandi Rashmitha	P	P	P	AB	P	P
53	15UP1A0557	Bareddy Sravanthi	P	P	P	P	AB	P
54	15UP1A0559	Boppidi Roopasri	P	P	P	P	AB	P
55	15UP1A0560	Chanda Varalaxmi	AB	AB	AB	P	P	AB
56	15UP1A0561	Chathelli Pranavi	P	P	P	AB	P	P
57	15UP1A0562	Chiraboina Ramadevi	P	P	P	P	AB	P
58	15UP1A0563	Chowdavarapu Lakshmi Priya	P	P	AB	P	P	P
59	15UP1A0564	Daripalli Amani	AB	AB	P	P	P	P
60	15UP1A0565	Edukulla Likitha	P	AB	P	P	P	P
61	15UP1A0567	Gopishetty Sahaja	P	P	P	P	AB	P
62	15UP1A0568	K Nava Jyothi	P	P	AB	P	P	P
63	15UP1A0569	Kandula Manmitha	P	P	P	P	P	P
64	15UP1A0570	Karla Amulya	P	AB	P	P	AB	P
65	15UP1A0571	L Sonali	P	P	P	P	P	P
66	15UP1A0572	Mandadi Mounika	P	P	P	AB	P	P
67	15UP1A0573	Maryala Dikshitha	P	P	P	P	P	P
68	15UP1A0574	Mende Kavya	P	AB	P	P	P	AB
69	15UP1A0575	Miryala Sri Lakshmi	P	P	P	P	P	P
70	15UP1A0576	Moola Vidya Sri	P	P	P	AB	P	P
71	15UP1A0577	N Usharani	P	P	P	P	P	P
72	15UP1A0578	Nandini	P	P	AB	P	P	P
73	15UP1A0579	Nanguburi Navya Sri	P	P	P	P	AB	AB



PRINCIPAL  
Vignana's Institute of Management & Technology for Women  
Kondapur(V), Ghatkesar(Dt), Medchal-Mahabubnagar(Dt)-501301  
Telangana State

74	15UPIA0580	Pendyala Lasya Priya	P	P	P	P	AB	P
75	15UPIA0581	Pininti Niharika Reddy	AB	P	P	P	P	P
76	15UPIA0582	Putta Deckshitha	P	P	P	P	P	P
77	15UPIA0583	Ramadevi Seelam	P	P	P	P	P	P
78	15UPIA0584	Ravalkole Manasa	P	AB	P	P	P	P
79	15UPIA0585	Ravirala Harshitha	P	P	P	P	AB	P
80	15UPIA0586	Relangi Vijaya Durga	P	D	P	P	P	P
81	15UPIA0587	Sagireddy Hevanya	P	P	P	P	P	P
82	15UPIA0588	Samala Anusha	AB	P	P	AB	P	P
83	15UPIA0589	Santhapuri Vaishnavi	P	P	P	P	P	AB
84	15UPIA0590	Soma Shruthi	P	P	P	P	P	P
85	15UPIA0591	Sumreddy Abhinaya	P	P	AB	P	AB	P
86	15UPIA0592	Sunkari Sowmya Reddy	P	P	P	P	P	P
87	15UPIA0593	Talapareddy Sanghavi	AB	P	P	P	P	P
88	15UPIA0594	Thirmani Bhavani	P	P	AB	P	P	P
89	15UPIA0595	Veeranala Manasa	P	P	P	P	P	P
90	15UPIA0596	Velapati Sowmya	P	P	AB	P	P	P
91	15UPIA0597	Veldurthi Sahithi	P	P	P	P	P	P
92	15UPIA0598	Vemi Reddy Lakshmi Kalyani	P	P	P	AB	P	P
93	15UPIA0599	Vodde Divya	P	P	P	P	AB	AB
94	15UPIA05A1	Vootukury Pravallika	AB	P	P	P	P	P
95	15UPIA05A2	Voruganti Pravallika	P	P	AB	P	P	P
96	15UPIA05A3	Mahveen Arshi	P	P	P	P	P	AB



*VASH*  
**PRINCIPAL**  
 Vignana's Institute of Management & Technology For Women  
 Kondapur (V), Ghatsakar (M), Medchal, Malkajgiri (Dist), 501301  
 Telangana State



# VIGNAN'S INSTITUTE OF MANAGEMENT AND TECHNOLOGY FOR WOMEN

Sponsored by Lava Educational Society, Approved by AICTE, New Delhi & Affiliated to JNTUH, Hyderabad.  
Kondapur (V), Ghatkesar (M), Medchal - Malkajgiri (Dt.) - 501 301 TS INDIA  
Phone: +08615 200006/07/08 Email: info@vmtw.in

## DEPARTMENT OF COMPUTER SCIENCE AND ENGINEERING

Date: 09-09-2017

VMTW/ CSE/CIR / 2017-18/ 1

### CIRCULAR

Department of Computer Science and Engineering organized Training program GRE Coaching for 3rd year students that Program will be conducted in our college on from 10-09-2017 to 31-10-2017. Mr. T. Srajan Kumar Assistant Professor will be the overall Coordinator. The respective coordinators are requested to Coordinate and make the Program successful. All the students are needed to attend the program without fail.

Copy To:

1. CEO for information,
2. All the Deans,
3. The HOD (CSE / ECE / EEE / IT /AIML/ BSH)
4. IQAC,
5. Admin Office,
6. All Notice Boards,
7. Circulate to all Class Rooms,
8. File



*[Signature]*  
PRINCIPAL  
Vignan's Institute of Management & Technology For Women  
Kondapur (V), Ghatkesar (M), Medchal-Malkajgiri (Dt.)-501301  
Telangana State

*[Signature]*  
PRINCIPAL  
Vignan's Institute of Management & Technology For Women  
Kondapur (V), Ghatkesar (M), Medchal-Malkajgiri (Dt.)-501301  
Telangana State



Date: 03-11-2017

**Training placement cell**

**Report on GRE Training Program Conducted by Bheri Overseas**

**Name of the Program:** Training Program for "GRE Coaching"

**Syllabus:** Analytical Writing Assessment (AWA) skills, Quantitative Reasoning skills, Verbal Reasoning skills, Analyze an Issue task and Analyze an Argument task, Reading Comprehension, Text Completion and Sentence Equivalence, Quantitative Comparison Questions, Multiple-choice Questions and Numeric Entry Questions.

**Objective:** Familiarizing Students with the GRE Format, Reviewing Content Knowledge, Enhancing Test-Taking Strategies, Practicing with Mock Tests

**Name of the Organization:** BHERI Overseas

**Course Instructor:** Anusha Beri

**Dates of the program:** 10-09-2017 to 31-10-2017

**Number of students attended:** 35



**Outcome:** Improved Understanding of GRE Format and Content, Enhanced Test-Taking Skills, Increased Subject Matter Proficiency, Improved Performance in Practice Tests, Higher GRE Scores, Boosted Confidence and Reduced Test Anxiety, Enhanced Application for Graduate Programs.

The undersigned thanked the respective department coordinators and BHERI Overseas, for their able support in completing the program successfully.



*[Handwritten Signature]*  
**PRINCIPAL**  
Vignans Institute of Management & Technology For Women  
Kondapur(V), Ghatkesar(M), Medchal-Malkajgiri(D)-501301  
Telangana State

Name of the Organization: **BHERI Overseas**

Course instructor: Anusha Beri

**Training & Placement Cell**

**GRE Training Program Conducted by BHERI Overseas**

Student Registration data for GRE Training Program

S.No	Roll No	Student Name	Department	Year
1	13UP1A0552	Polapalli Bhavya	CSE	IV
2	14UP1A0501	Banoth Jyothsna	CSE	IV
3	14UP1A0502	N Saharika	CSE	IV
4	14UP1A0503	Pittala Shruthi	CSE	IV
5	14UP1A0504	Pollapalli Shravya Reddy	CSE	IV
6	14UP1A0506	Rekula Vani	CSE	IV
7	14UP1A0507	Siddipeta Jaya	CSE	IV
8	14UP1A0508	Singi Reddy Divya	CSE	IV
9	13UP1A0466	N Vindhya	ECE	IV
10	14UP1A0401	Bukya Mounika	ECE	IV
11	14UP1A0402	Gangaramaina Navaneetha	ECE	IV
12	14UP1A0403	Sepuri Navya	ECE	IV
13	15UP1A0567	Gopishetty Sahaja	CSE	III
14	15UP1A0568	K Nava Jyothi	CSE	III
15	15UP1A0569	Kandula Manmitha	CSE	III
16	15UP1A0570	Karla Amulya	CSE	III
17	15UP1A0571	L Sonali	CSE	III
18	15UP1A0572	Mandadi Mounika	CSE	III
19	15UP1A0414	Gangapuram Himaja	ECE	III
20	15UP1A0415	Gopaladas Mounika	ECE	III
21	15UP1A0416	Gunda Devika	ECE	III
22	15UP1A0417	Gunti Sravani	ECE	III
23	15UP1A0418	Harivenkatanaga Haripriya	ECE	III
24	15UP1A0419	Jakkidi Pranaya	ECE	III
25	15UP1A0472	Pochampally Priyanka	ECE	III
26	15UP1A0473	Pothepaka Manasa	ECE	III
27	15UP1A0474	Sheela Nikitha	ECE	III
28	15UP1A0475	Sherikar Priyanka	ECE	III
29	15UP1A0476	SHIVA SIKHITHA	ECE	III



*Handwritten signature*  
**PRINCIPAL**  
Vignans Institute of Management & Technology For Women  
Kondapur(V), Ghatkesar(M), Medchal-Malkajgiri(D), Pin: 501201  
Telangana State

30	15UP1A0477	Sunki Kalyani	ECE	III
31	15UP1A0478	Vemuri Mahathi	ECE	III
32	15UP1A0479	Yasa Minisha Reddy	ECE	III
33	15UP1A0549	Swargam Mounika	CSE	IV
34	15UP1A0550	Thoutam Chandana	CSE	IV
35	15UP1A0551	Valaboju Divya Sri	CSE	IV



*[Handwritten Signature]*  
**PRINCIPAL**  
 Vignani's Institute of Management & Technology For Women  
 Kondapur(V), Ghatkesar (M), Medchal-Malkajgiri(D)-501301



# VIGNAN'S INSTITUTE OF MANAGEMENT AND TECHNOLOGY FOR WOMEN

Sponsored by Laxmi Educational Society, Approved by AICTE, New Delhi & Affiliated to JNTUH, Hyderabad.  
Kondapur (V), Ghatkesar (M), Medchal - Malkajgiri (D) - 501 301 TS INDIA  
Phone: +08615 200006/07/08 Email: info@vmtw.in

## DEPARTMENT OF ELECTRONICS AND COMMUNICATION ENGINEERING

VMTW/ECE/AOC/CIR/2018-19/I/03

07-09-2018.

### CIRCULAR

This is to inform all the IV B. Tech ECE students that there will be an Add on course on "Design and FPGA Implementation of DSP Processor using Verilog" in association with AMTRONICS PVT LTD., Hyderabad, on 11-09-2018 to 29-10-2018 All students are invited to take part in this course. The participating students will be honored with certificates of participation. During the course you will be encouraged to interact with the speaker and the other participants through the case study discussions. Hence those who are interested can sign in registration form.

HOD,ECE.

Copy to

The Principal, for kind information

IQAC

Notice board

IV.B.Tech students

Dept. file

Head of the Department  
Electronics and Communication Engineering  
Vignan's Institute of Management and Technology for Women  
Kondapur (V), Ghatkesar (M), R.R. Dist-501 301



PRINCIPAL

Vignan's Institute of Management & Technology For Women  
Kondapur(V),Ghatkesar(M),Medchal-Malkajgiri(D)-501301  
Telangana State

### About the Course:

The digital signal processing (DSP) applications are in numerous infotainments, Medical diagnostics and advanced communication and radar systems. Always the advancements in VLSI technology will have an impact on the performance of these systems. VLSI DSP deals with such architectural and algorithmic optimization techniques to design high-performance DSP systems. As VLSI DSP needs inter-domain expertise of both DSP and VLSI domain, there is a huge necessity to impart the necessary concepts and hands-on skills to research scholars and faculty.

### Course Objectives:

- Introduction to DSP VLSI
- Architectural transformation techniques (Retiming, Folding)
- Architectural transformation techniques (Unfolding)
- Numerical Strength reduction techniques
- Hands-on MATLAB for VLSI DSP
- Introduction to INTEL FPGA Design flow
- Introduction to DSP Builder
- Design flow using DSP Builder
- Industry practice and trends in DSP VLSI system Design flow

### Expected Outcomes:

- At the end of Workshop, participants will be able to
- Simulate and verify a design.
  - Work with real time projects using Architectural transformation techniques (Retiming, Folding).
  - Work with real time projects using Architectural transformation techniques (Unfolding).
  - Work with real time projects using Numerical Strength reduction techniques.
  - Work with real time projects using DSP Builder.

# VIGNAN'S INSTITUTE OF MANAGEMENT AND TECHNOLOGY FOR WOMEN

(Sponsored by Lavu Educational Society)

Approved by AICTE, New Delhi & Affiliated to JNTUH, Hyderabad.  
Kondapur (V), Ghatkesar (M), Medchal - Malkajgiri (D) - 501 301



## ADD-ON COURSE ON "DESIGN & FPGA

## IMPLEMENTATION OF DSP PROCESSOR USING VERILOG"

11<sup>TH</sup> SEP TO 29<sup>TH</sup> OCT, 2018

Duration of the Course: 32 Hrs

Venue:

'B'-Block Seminar Hall,  
VMTW.

Organized By:

DEPARTMENT OF ELECTRONICS AND  
COMMUNICATION ENGINEERING 550



Resource Person:

**Mr. Arjun Mohan**

Sr. Engineer,

Amtronics, Hyderabad.

Co-ordinator:

**Mr. J. Sunil Kumar,**

Assistant Professor, Dept. of ECE,

Contact No: +91 83747 17668

*AA*  
PRINCIPAL  
Vignan's Institute of Management & Technology For Women  
Kondapur(V), Ghatkesar(M), Medchal-Malkajgiri (D) - 501301  
Telangana State

Last Date For Registration: 16<sup>th</sup> Aug, 2018





# VIGNAN'S INSTITUTE OF MANAGEMENT AND TECHNOLOGY FOR WOMEN

Sponsored by Laxmi Educational Society, Approved by AICTE, New Delhi & Affiliated to JNTUH, Hyderabad.  
Kondapur (V), Ghathkotasar (M), Medchal - Malkajgiri (D) - 501 301 TS INDIA  
Phone: +08815 200006/07/08 Email: info@vmtw.in

## DEPARTMENT OF ELECTRONICS AND COMMUNICATION ENGINEERING

ADD ON COURSE NAME: Design and FPGA Implementation of DSP Processor using Verilog

Academic Year: 2018-19

Date: 07-09-2018

B.Tech IV-I SEM

DAY WISE SCHEDULE SHEET

SECTION: ECE-A&B

Room number: BFF6

S.no	DAY	Topic	Timings	Duration
1.	11-09-18	Introduction to embedded	04:00pm to 05:00pm	1 hour
2.	12-09-18	Application Areas	04:00pm to 05:00pm	1 hour
3.	14-09-18	Categories of embedded processors	04:00pm to 05:00pm	1 hour
4.	15-09-18	Hardware architecture	04:00pm to 05:00pm	1 hour
5.	17-09-18	Software architecture	04:00pm to 05:00pm	1 hour
6.	18-09-18	Application software	04:00pm to 05:00pm	1 hour
7.	19-09-18	Communication software	04:00pm to 05:00pm	1 hour
8.	20-09-18	Introduction to Harvard	04:00pm to 05:00pm	1 hour
9.	22-09-18	Architectures	04:00pm to 05:00pm	1 hour
10.	24-09-18	CISC & RISC Architectures	04:00pm to 05:00pm	1 hour
11.	25-09-18	CISC & RISC Architectures	04:00pm to 05:00pm	1 hour
12.	26-09-18	PIC Microcontrollers	04:00pm to 05:00pm	1 hour
13.	27-09-18	Introduction to PIC	04:00pm to 05:00pm	1 hour
14.	28-09-18	Architecture and memory	04:00pm to 05:00pm	1 hour
15.	29-09-18	Registers, I/O ports	04:00pm to 05:00pm	1 hour
16.	01-10-18	Interrupts	04:00pm to 05:00pm	1 hour
17.	03-10-18	Timer, instruction sets	04:00pm to 05:00pm	1 hour
18.	04-10-18	PIC programming in assembly and	04:00pm to 05:00pm	1 hour
19.	05-10-18	Sensor interfacing	04:00pm to 05:00pm	1 hour
20.	06-10-18	Motor control	04:00pm to 05:00pm	1 hour
21.	08-10-18	SPI bus protocols	04:00pm to 05:00pm	1 hour
22.	09-10-18	ARM design philosophy	04:00pm to 05:00pm	1 hour
23.	10-10-18	data flow model and core	04:00pm to 05:00pm	1 hour
24.	11-10-18	ARM processor families	04:00pm to 05:00pm	1 hour
25.	12-10-18	Instruction Sets	04:00pm to 05:00pm	1 hour
26.	13-10-18	Data processing instructions	04:00pm to 05:00pm	1 hour
27.	15-10-18	Addressing modes	04:00pm to 05:00pm	1 hour
28.	16-10-18	conditional instructions	04:00pm to 05:00pm	1 hour
29.	20-10-18	Raspberry Pi	04:00pm to 05:00pm	1 hour
30.	22-10-18	Programming the Raspberry Pi	04:00pm to 05:00pm	1 hour
31.	24-10-18	Communication facilities on	04:00pm to 05:00pm	1 hour

Vignan's Institute of Management & Technology for Women  
Kondapur(V), Ghathkotasar(M), Medchal-Malkajgiri(D)-501301  
Telangana State



		Raspberry Pi		
32.	25-10-18	Interfacing of sensors and actuators	04:00pm to 05:00pm	1 hour
33.	27-10-18	Intel Galileo	04:00pm to 05:00pm	1 hour
34.	29-10-18	$\mu$ for Embedded System and IoT	04:00pm to 05:00pm	1 hour
35.	29-10-18	Test conducted & Feedback Taken	04:00pm to 05:00pm	1 hour
<b>Total 35 hours</b>				

  
Coordinator

  
HOD

**Head of the Department**  
Electronics and Communication Engineering  
Vignan's Institute of Management and Technology for Women  
Kondepur (V), Ghatkesar (M), R.R. Dist-501 301





**PRINCIPAL**  
Vignan's Institute of Management & Technology for Women  
Kondepur(V),Ghatkesar(M),Madhuk-Malkajgiri(D)-501301  
Telangana State



# VIGNAN'S INSTITUTE OF MANAGEMENT AND TECHNOLOGY FOR WOMEN

Sponsored by Laxmi Educational Society, Approved by AICTE, New Delhi & Affiliated to JNTU, Hyderabad.  
Kondapur (V), Ghatakesar (M), Medchal - Malkajgiri (D) - 501 301 TS INDIA  
Phone: +08615 200066/07/08 Email: info@vmtw.in

## DEPARTMENT OF ELECTRONICS AND COMMUNICATION ENGINEERING

ADD ON COURSE NAME: Design and FPGA Implementation of DSP Processor using Verilog

Academic Year: 2018-19

Date: 11-09-2018

B.Tech IV-I SEM

STUDENT REGISTRATION LIST

SECTION: ECE-A

S.No	Roll number	Name of the student	Signature
1.	15UP1A0401	BEDUDHURI MEGHANA	Meghana
2.	15UP1A0402	C VARSHA REDDY	Varsha
3.	15UP1A0403	CHENNU LAXMI PRASANNA	Laxmi
4.	15UP1A0405	CHILUMULA RACHANA	Rachana
5.	15UP1A0406	CHUNCHU RAMYA SRI	Ramyasri
6.	15UP1A0407	DADI SHIVANJALI	Anjali
7.	15UP1A0408	DEVARAKONDA KEERTHI	Keerthi
8.	15UP1A0409	DEVARAKONDA PREETHI	Preethi
9.	15UP1A0410	DHODLA ALEKHYA	Alekhyasri
10.	15UP1A0411	DUMALA PRIYANKA	Priyanka
11.	15UP1A0412	G VYSHNAVI	Vyshnavi
12.	15UP1A0414	GANGAPURAM HIMAJA	Himaja
13.	15UP1A0415	GOPALADAS MOUNIKA	Mounika
14.	15UP1A0416	GUNDA DEVIKA	Devika
15.	15UP1A0417	GUNTI SRAVANI	Sravani
16.	15UP1A0418	HARIVENKATANAGA HARIPRIYA	Haripriya
17.	15UP1A0419	JAKKIDI PRANAYA	Pranaya
18.	15UP1A0420	KAKANI TEJA SRI	Tejasri
19.	15UP1A0421	KANDADI NIKHITHA	Nikhitha
20.	15UP1A0422	KANDHATI UMA	Uma
21.	15UP1A0423	KETHIREDDY PRATHYUSHA	Prathyusha
22.	15UP1A0424	KODEMALA SAIKRUPA	Saikrupa
23.	15UP1A0425	KOLA SONIA	K.Sonia
24.	15UP1A0426	L VIJITHA	Vijitha
25.	15UP1A0427	MAINELLY NIKHITHA	Nikhitha
26.	15UP1A0428	MALLELA MAMATHA	Mamatha
27.	15UP1A0429	MATTI PALLAVI	Pallavi
28.	15UP1A0430	MOJJA KAVERI	Kaveri
29.	15UP1A0431	MULLAPUDI VENKATA LIKHITA	Likhita
30.	15UP1A0432	PABBA VIKASINI	Vikasini
31.	15UP1A0434	PALADUGULA SRIKAVYA	Kavya
32.	15UP1A0435	PAPINENI BHAVANA	Bhavana
33.	15UP1A0436	PERUGUPALLI VIDYULLEKHA	Vidya



*Vignans*  
Vignans Institute of Management & Technology for Women  
Kondapur(V), Ghatakesar(M), Medchal-Malkajgiri(D)-501301  
Telangana State

34.	15UP1A0437	PINNAPU REDDY RAMYA	Ramyra
35.	15UP1A0438	S AMRUTHA VARSHINI	Varshini
36.	15UP1A0439	SALLA VARSHINI	Varshini
37.	15UP1A0440	SAMUDRALA NANDINI	Nandini
38.	15UP1A0401	BEDUDHURI MEGHANA	Meghana
39.	15UP1A0402	C VARSHA REDDY	Varsha
40.	15UP1A0403	CHENNU LAXMI PRASANNA	Prasanna

  
**COORDINATOR**

  
**ECE, HOD**

**Head of the Department**  
 Electronics and Communication Engineering  
 Vigyan's Institute of Management and Technology For Women  
 Gandapur (V), Ghatkesar (M), Medchal-Malkajgiri (Dt)-501301



  
**PRINCIPAL**  
 Vigyan's Institute of Management & Technology For Women  
 Gandapur(V), Ghatkesar(M), Medchal-Malkajgiri(Dt)-501301  
 Telangana State



# VIGNAN'S INSTITUTE OF MANAGEMENT AND TECHNOLOGY FOR WOMEN

Sponsored by Laxvi Educational Society, Approved by AICTE, New Delhi & Affiliated to INTUH, Hyderabad.  
Kondapur (V), Ghafkisar (M), Medchal - Malkajgiri (D) - 501 301 TS INDIA.  
Phone: +91815 200005/07/08 Email: info@vmtw.in

## DEPARTMENT OF ELECTRONICS AND COMMUNICATION ENGINEERING

ADD ON COURSE NAME: Design and FPGA Implementation of DSP Processor using Verilog

Academic Year: 2018-19

Date: 11-09-2018

B.Tech IV-I SEM

STUDENT REGISTERED LIST

SECTION: ECE-A

S.No	Roll number	Name of the student
1.	15UPIA0401	BEDUDHURI MEGHANA
2.	15UPIA0402	C VARSHA REDDY
3.	15UPIA0403	CHENNU LAXMI PRASANNA
4.	15UPIA0405	CHILUMULA RACHANA
5.	15UPIA0406	CHUNCHU RAMYA SRI
6.	15UPIA0407	DADI SHIVANJALI
7.	15UPIA0408	DEVARAKONDA KEERTHI
8.	15UPIA0409	DEVARAKONDA PREETHI
9.	15UPIA0410	DHODLA ALEKHYA
10.	15UPIA0411	DUMALA PRIYANKA
11.	15UPIA0412	G VYSHNAVI
12.	15UPIA0414	GANGAPURAM HIMAJA
13.	15UPIA0415	GOPALADAS MOUNIKA
14.	15UPIA0416	GUNDA DEVIKA
15.	15UPIA0417	GUNTI SRAVANI
16.	15UPIA0418	HARIVENKATANAGA HARIPRIYA
17.	15UPIA0419	JAKKIDI PRANAYA
18.	15UPIA0420	KAKANI TEJA SRI
19.	15UPIA0421	KANDADI NIKHITHA
20.	15UPIA0422	KANDHATI UMA
21.	15UPIA0423	KETHIREDDY PRATHYUSHA
22.	15UPIA0424	KODEMALA SAIKRUPA
23.	15UPIA0425	KOLA SONIA
24.	15UPIA0426	L VIJITHA
25.	15UPIA0427	MAINELLY NIKHITHA
26.	15UPIA0428	MALLELA MAMATHA
27.	15UPIA0429	MATTI PALLAVI
28.	15UPIA0430	MOJJA KAVERI
29.	15UPIA0431	MULLAPUDI VENKATA LIKHITA
30.	15UPIA0432	PABBA VIKASINI
31.	15UPIA0434	PALADUGULA SRIKAVYA
32.	15UPIA0435	PAPINENI BHAVANA
33.	15UPIA0436	PERUGUPALLI VIDYULLEKHA



  
PRINCIPAL

Vignans Institute of Management & Technology For Women  
Kondapur(V), Ghafkisar(M), Medchal-Malkajgiri(D)-501301  
Telangana State

34.	15UP1A0437	PINNAPU REDDY RAMYA
35.	15UP1A0438	S AMRUTHA VARSHINI
36.	15UP1A0439	SALLA VARSHINI
37.	15UP1A0440	SAMUDRALA NANDINI
38.	15UP1A0401	BEDUDHURI MEGHANA
39.	15UP1A0402	C VARSHA REDDY
40.	15UP1A0403	CHENNU LAXMI PRASANNA

  
COORDINATOR

  
HOD

Head of the Department  
Electronics and Communication Engineering  
Vignana's Institute of Management and Technology For Women  
Kondapur (V), Ghatkesar (M), R.R. Dist-591-301



  
PRINCIPAL

Vignana's Institute of Management & Technology For Women  
Kondapur(V), Ghatkesar(M), Medchal-Malkajgiri(Dist)-591-301  
Telangana State



# VIGNAN'S INSTITUTE OF MANAGEMENT AND TECHNOLOGY FOR WOMEN

Sponsored by Laxmi Educational Society, Approved by AICTE, New Delhi & Affiliated to JNTU, Hyderabad.  
Kondapur (V), Ghatakesar (M), Medchal - Malkajgiri (D) - 501 301 TS INDIA  
Phone: +08615 200006/07/08 Email: info@vmtw.in

## DEPARTMENT OF ELECTRONICS AND COMMUNICATION ENGINEERING

ADD ON COURSE NAME: Design and FPGA Implementation of DSP Processor using Verilog

Academic Year: 2018-19

Date: 11-09-2018

B.Tech IV-I

STUDENT REGISTRATION LIST

SECTION: ECE-B

S.No	Roll number	Name of the student	Signature
1.	15UP1A0441	SUDAGANI SWETHA	Swetha
2.	15UP1A0442	VONTARI ARCHANA	Archana
3.	15UP1A0443	MANASA REDDY BODELA	Manasa
4.	15UP1A0444	BALA THARUNA KEERTHI	Keerthi
5.	15UP1A0445	BANALA PRIYANKA	Priyanka
6.	15UP1A0446	BANGARAM MAMATHA	Mamatha
7.	15UP1A0447	BASIREDDY BHARATHI REDDY	Bharathi
8.	15UP1A0448	BILLAKANTI RAVALI	Ravali
9.	15UP1A0449	DEEKONDA SUGANDHA	Sugandha
10.	15UP1A0450	GADDAM JOSHNA	Joshna
11.	15UP1A0451	GOGINENI NIKITHA	Nikitha
12.	15UP1A0452	GUNDAGANI NAGASHIRISHA	Shirisha
13.	15UP1A0453	JALA MOUNIKA	Mounika
14.	15UP1A0454	K RAMYA REDDY	Ramya
15.	15UP1A0455	KANALA KAVYA REDDY	Kavya
16.	15UP1A0456	KANDUKURI SRAVYA	Sravya
17.	15UP1A0457	KARNATI SRIHARSHA	Harsha
18.	15UP1A0458	KASULA NAVYA SRI	Navya
19.	15UP1A0459	KETHIREDDY RAMYA	Ramya
20.	15UP1A0460	KOMATIREDDY SIRIJA	Sirija
21.	15UP1A0461	LAVANYA SEELAM	Lavanya
22.	15UP1A0462	M HARICHANDANA	Chandana
23.	15UP1A0463	MAHAJAN SRADHA	Sradha
24.	15UP1A0464	MANCHALA SHIVAPRIYA	Shivapriya
25.	15UP1A0465	MANTIPALLY PRAVALIKA	Pravalika
26.	15UP1A0466	METTU SRAVANTHI	Sravanthi
27.	15UP1A0467	MUNAGALA YASHASWINI	M. Yashaswini
28.	15UP1A0468	NAGANOLLU ANUSHA REDDY	Anusha
29.	15UP1A0469	PACHA VEDASRI	Veda
30.	15UP1A0470	VENKATA YASHASWINI	Yashaswini
31.	15UP1A0472	POCHAMPALLY PRIYANKA	Priyanka
32.	15UP1A0473	POTHEPAKA MANASA	Manasa
33.	15UP1A0474	SHEELA NIKITHA	Nikitha



*WASH*  
PRINCIPAL

Vignani's Institute of Management & Technology For Women  
Kondapur(V), Ghatakesar(M), Medchal-Malkajgiri(D)-501301  
Telangana State

34.	15UP1A0475	SHERIKAR PRIYANKA	<i>Sherikar Priyanka</i>
35.	15UP1A0476	SHIVA NIKHITHA	<i>Nikhitha</i>
36.	15UP1A0477	SUNKI KALYANI	<i>Kalyani</i>
37.	15UP1A0478	VEMURI MAHATHI	<i>Mahathi</i>
38.	15UP1A0479	YASA MINISHA REDDY	<i>Minisha</i>
39.	15UP1A0480	YERUVA SAGAR BALA DIVYA	<i>Y. Divya</i>

*[Signature]*  
**COORDINATOR**

*[Signature]*  
**ECE,HOD**

**Head of the Department**  
 Electronics and Communication Engineering  
 Vignans Institute of Management and Technology For Women  
 Kondapur (V), Ghatkesar (M), Medchal-Malkajgiri (O)-501301



*[Signature]*  
**PRINCIPAL**  
 Vignans Institute of Management & Technology For Women  
 Kondapur(V),Ghatkesar(M),Medchal-Malkajgiri(O)-501301  
 Telangana State





# VIGNAN'S INSTITUTE OF MANAGEMENT AND TECHNOLOGY FOR WOMEN

Sponsored by Savu Educational Society, Approved by AICTE, New Delhi & Affiliated to JNTUH, Hyderabad.  
Kondapur (V), Ghatkesar (M), Medchal - Malkajgiri (D) - 501 301 TS INDIA  
Phone: +08815 20006/07/08 Email: info@vmlw.in

## DEPARTMENT OF ELECTRONICS AND COMMUNICATION ENGINEERING

ADD ON COURSE NAME: Design and FPGA Implementation of DSP Processor using Verilog

Academic Year: 2018-19

Date: 11-09-2018

B.Tech IV-I SEM

STUDENT REGISTERED LIST

SECTION: ECE-B

S.No	Roll number	Name of the student
1.	15UP1A0441	SUDAGANI SWETHA
2.	15UP1A0442	VONTARI ARCHANA
3.	15UP1A0443	MANASA REDDY BODELA
4.	15UP1A0444	BALA THARUNA KEERTHI
5.	15UP1A0445	BANALA PRIYANKA
6.	15UP1A0446	BANGARAM MAMATHA
7.	15UP1A0447	BASIREDDY BHARATHI REDDY
8.	15UP1A0448	BILLAKANTI RAVALI
9.	15UP1A0449	DEEKONDA SUGANDHA
10.	15UP1A0450	GADDAM JOSHNA
11.	15UP1A0451	GOGINENI NIKITHA
12.	15UP1A0452	GUNDAGANI NAGASHIRISHA
13.	15UP1A0453	JALA MOUNIKA
14.	15UP1A0454	K RAMYA REDDY
15.	15UP1A0455	KANALA KAVYA REDDY
16.	15UP1A0456	KANDUKURI SRAVYA
17.	15UP1A0457	KARNATI SRIHARSHA
18.	15UP1A0458	KASULA NAVYA SRI
19.	15UP1A0459	KETHIREDDY RAMYA
20.	15UP1A0460	KOMATIREDDY SIRIJA
21.	15UP1A0461	LAVANYA SEELAM
22.	15UP1A0462	M HARICHANDANA
23.	15UP1A0463	MAHAJAN SRADHA
24.	15UP1A0464	MANCHALA SHIVAPRIYA
25.	15UP1A0465	MANTIPALLY PRAVALIKA
26.	15UP1A0466	METTU SRAVANTHI
27.	15UP1A0467	MUNAGALA YASHASWINI
28.	15UP1A0468	NAGANOLLU ANUSHA REDDY
29.	15UP1A0469	PACHA VEDASRI
30.	15UP1A0470	VENKATA YASHASWINI
31.	15UP1A0471	PERAMALLA KAVYA
32.	15UP1A0472	POCHAMPALLY PRIYANKA
33.	15UP1A0473	POTHEPAKA MANASA
34.	15UP1A0474	SHEELA NIKITHA



*Vignan's*  
PRINCIPAL  
Vignan's Institute of Management & Technology For Women  
Kondapur(V), Ghatkesar(M), Medchal-Malkajgiri(D)-501301  
Telangana State

35.	15UP1A0475	SHERIKAR PRIYANKA
36.	15UP1A0476	SHIVA NIKHITHA
37.	15UP1A0477	SUNKI KALYANI
38.	15UP1A0478	VEMURI MAHATHI
39.	15UP1A0479	YASA MINISHA REDDY
40.	15UP1A0480	YERUVA SAGAR BALA DIVYA

  
COORDINATOR

  
HOD

Head of the Department  
Electronics and Communication Engineering  
Vignaa's Institute of Management and Technology for Women  
Kondapur (V), Ghatkesar (M), R.R. Dist-501 301



  
PRINCIPAL  
Vignaa's Institute of Management & Technology for Women  
Kondapur(V), Ghatkesar(M), Medchal-Malkajgiri(DR)-501301  
Telangana State



# VIGNAN'S INSTITUTE OF MANAGEMENT AND TECHNOLOGY FOR WOMEN

Sponsored by Law Educational Society, Approved by AICTE, New Delhi & Affiliated to JNTUH, Hyderabad.  
Kondapur (V), Ghatkesar (M), Medchal - Malkajgiri (D) - 501 301 TS INDIA  
Phone: +08615 2000607/08 Email: info@vmtw.in

## DEPARTMENT OF ELECTRONICS AND COMMUNICATION ENGINEERING

ADD ON COURSE NAME: Design and FPGA Implementation of DSP Processor using Verilog

Academic Year: 2018-19

Date: 11-09-2018

B.Tech IV-I SEM

DAY WISE ATTENDANCE SHEET

SECTION: ECE-A

S.No	Roll number	11-09-18	12-09-18	14-09-18	15-09-18	17-09-18
1.	15UP1A0401	Ma	Ma	Ma	Ma	Ma
2.	15UP1A0402	Vaishu	Vaishu	Vaishu	Vaishu	Vaishu
3.	15UP1A0403	Laxmi	Laxmi	Laxmi	Laxmi	Laxmi
4.	15UP1A0405	Rubana	Rubana	Rubana	Rubana	Rubana
5.	15UP1A0406	Ranya	Ranya	Ranya	Ranya	Ranya
6.	15UP1A0407	Anjali	Anjali	Anjali	Anjali	Anjali
7.	15UP1A0408	Keerthi	Keerthi	Keerthi	Keerthi	Keerthi
8.	15UP1A0409	Poothi	Poothi	Poothi	Poothi	Poothi
9.	15UP1A0410	Alekya	Alekya	Alekya	Alekya	Alekya
10.	15UP1A0411	Priyanka	Priyanka	Priyanka	Priyanka	Priyanka
11.	15UP1A0412	Vyshnavi	Vyshnavi	Vyshnavi	Vyshnavi	Vyshnavi
12.	15UP1A0414	Hiraja	Hiraja	Hiraja	Hiraja	Hiraja
13.	15UP1A0415	Manika	Manika	Manika	Manika	Manika
14.	15UP1A0416	Devika	Devika	Devika	Devika	Devika
15.	15UP1A0417	Shravani	Shravani	Shravani	Shravani	Shravani
16.	15UP1A0418	Prathyusha	Prathyusha	Prathyusha	Prathyusha	Prathyusha
17.	15UP1A0419	Pranaya	Pranaya	Pranaya	Pranaya	Pranaya
18.	15UP1A0420	Tejasvi	Tejasvi	Tejasvi	Tejasvi	Tejasvi
19.	15UP1A0421	Nikitha	Nikitha	Nikitha	Nikitha	Nikitha
20.	15UP1A0422	Uma	Uma	Uma	Uma	Uma
21.	15UP1A0423	Prathyusha	Prathyusha	Prathyusha	Prathyusha	Prathyusha
22.	15UP1A0424	Sai Krupa	Sai Krupa	Sai Krupa	Sai Krupa	Sai Krupa
23.	15UP1A0425	K.Sonia	K.Sonia	K.Sonia	K.Sonia	K.Sonia
24.	15UP1A0426	Vijetha	Vijetha	Vijetha	Vijetha	Vijetha
25.	15UP1A0427	Nikhitha	Nikhitha	Nikhitha	Nikhitha	Nikhitha
26.	15UP1A0428	Manmatha	Manmatha	Manmatha	Manmatha	Manmatha
27.	15UP1A0429	Pallavi	Pallavi	Pallavi	Pallavi	Pallavi
28.	15UP1A0430	Shravan	Shravan	Shravan	Shravan	Shravan
29.	15UP1A0431	Hikmat	Hikmat	Hikmat	Hikmat	Hikmat
30.	15UP1A0432	Vikasini	Vikasini	Vikasini	Vikasini	Vikasini
31.	15UP1A0434	Kavya	Kavya	Kavya	Kavya	Kavya
32.	15UP1A0435	Bhavana	Bhavana	Bhavana	Bhavana	Bhavana
33.	15UP1A0436	Vidya	Vidya	Vidya	Vidya	Vidya



  
PRINCIPAL

Vignans Institute of Management & Technology For Women  
Kondapur(V), Ghatkesar(M), Medchal-Malkajgiri(D), 501301  
Telangana State

34.	15UPIA0437	Ramya	Ramya	Ramya	Ramya	Ramya
35.	15UPIA0438	Varshini	Varshini	Varshini	Varshini	Varshini
36.	15UPIA0439	Varshini	Varshini	Varshini	Varshini	Varshini
37.	15UPIA0440	Nandini	Nandini	Nandini	Nandini	Nandini
38.	15UPIA0401	Meghana	Meghana	Meghana	Meghana	Meghana
39.	15UPIA0402	Varsha	Varsha	Varsha	Varsha	Varsha
40.	15UPIA0403	Prasanna	Prasanna	Prasanna	Prasanna	Prasanna

  
COORDINATOR

  
ECE, HOD

Head of the Department  
Electronics and Communication Engineering  
Vignar's Institute of Management and Technology For Women  
Kondapur (V), Ghatkesar (M), H.R. Dist-501 301



  
PRINCIPAL  
Vignar's Institute of Management & Technology For Women  
Kondapur(V), Ghatkesar(M), Medchal-Malkajgiri(D),  
Telangana State



# VIGNAN'S INSTITUTE OF MANAGEMENT AND TECHNOLOGY FOR WOMEN

Sponsored by Laxmi Educational Society, Approved by AICTE, New Delhi & Affiliated to JNTUW, Hyderabad.  
Kondapur (V), Ghatkesar (M), Medchal - Malkajgiri (D) - 501 301 TS INDIA  
Phone: +08615 20006/07/08 Email: info@vmtw.in

## DEPARTMENT OF ELECTRONICS AND COMMUNICATION ENGINEERING

ADD ON COURSE NAME: Design and FPGA Implementation of DSP Processor using Verilog

Academic Year: 2018-19

Date: 11-09-2018

B.Tech IV-I SEM

DAY WISE ATTENDANCE SHEET

SECTION: ECE-B

S.No	Roll number	11-09-18	12-09-18	14-09-18	15-09-18	17-09-18
1.	15UPIA0441	Swetha	Swetha	Swetha	Swetha	Swetha
2.	15UPIA0442	Archana	Archana	Archana	Archana	Archana
3.	15UPIA0443	Manam	Manam	Manam	Manam	Manam
4.	15UPIA0444	Keerthi	Keerthi	Keerthi	Keerthi	Keerthi
5.	15UPIA0445	Prinyata	Prinyata	Prinyata	Prinyata	Prinyata
6.	15UPIA0446	Manasika	Manasika	Manasika	Manasika	Manasika
7.	15UPIA0447	Bhawalhi	Bhawalhi	Bhawalhi	Bhawalhi	Bhawalhi
8.	15UPIA0448	Ravali	Ravali	Ravali	Ravali	Ravali
9.	15UPIA0449	Sru	Sru	Sru	Sru	Sru
10.	15UPIA0450	Joshna	Joshna	Joshna	Joshna	Joshna
11.	15UPIA0451	S.Nikitha	S.Nikitha	S.Nikitha	S.Nikitha	S.Nikitha
12.	15UPIA0452	Sricha	Sricha	Sricha	Sricha	Sricha
13.	15UPIA0453	Ra	Ra	Ra	Ra	Ra
14.	15UPIA0454	K.Raj	K.Raj	K.Raj	K.Raj	K.Raj
15.	15UPIA0455	Kavya	Kavya	Kavya	Kavya	Kavya
16.	15UPIA0456	Aranya	Aranya	Aranya	Aranya	Aranya
17.	15UPIA0457	Harsha	Harsha	Harsha	Harsha	Harsha
18.	15UPIA0458	Nanya	Nanya	Nanya	Nanya	Nanya
19.	15UPIA0459	Pooja	Pooja	Pooja	Pooja	Pooja
20.	15UPIA0460	Sirija	Sirija	Sirija	Sirija	Sirija
21.	15UPIA0461	Laranya	Laranya	Laranya	Laranya	Laranya
22.	15UPIA0462	Chandana	Chandana	Chandana	Chandana	Chandana
23.	15UPIA0463	Ra	Ra	Ra	Ra	Ra
24.	15UPIA0464	Shivapriya	Shivapriya	Shivapriya	Shivapriya	Shivapriya
25.	15UPIA0465	Pravalika	Pravalika	Pravalika	Pravalika	Pravalika
26.	15UPIA0466	Sravanthi	Sravanthi	Sravanthi	Sravanthi	Sravanthi
27.	15UPIA0467	M.Yasr	M.Yasr	M.Yasr	M.Yasr	M.Yasr
28.	15UPIA0468	Anusha	Anusha	Anusha	Anusha	Anusha
29.	15UPIA0469	Veda	Veda	Veda	Veda	Veda
30.	15UPIA0470	Yash	Yash	Yash	Yash	Yash
31.	15UPIA0472	Pritya	Pritya	Pritya	Pritya	Pritya
32.	15UPIA0473	Manasa	Manasa	Manasa	Manasa	Manasa
33.	15UPIA0474	Nikitha	Nikitha	Nikitha	Nikitha	Nikitha



  
PRINCIPAL

Vignans Institute of Management & Technology For Women  
Kondapur(V), Ghatkesar(M), Medchal - Malkajgiri (D) - 501 301  
Telangana State

34	15UPIA0475	dipriyanka	dipriyanka	dipriyanka	dipriyanka	dipriyanka
35	15UPIA0476	Nikitha	Nikitha	Nikitha	Nikitha	Nikitha
36	15UPIA0477	kalyani	kalyani	kalyani	kalyani	kalyani
37	15UPIA0478	Mahathi	Mahathi	Mahathi	Mahathi	Mahathi
38	15UPIA0479	Minisha	Minisha	Minisha	Minisha	Minisha
39	15UPIA0480	V.P.S	V.P.S	V.P.S	V.P.S	V.P.S

  
COORDINATOR

  
ECE.HOD

Head of the Department  
Electronics and Communicative Engineering  
Vignana Institute of Management and Technology, 1<sup>st</sup> Floor,  
Kondapur (V), Ghatkesar (M), R.R. Dist-501 301



  
PRINCIPAL  
Vignana's Institute of Management & Technology for Women  
Kondapur (V), Ghatkesar (M), Medchal-Malkajgiri (DR)-501301  
Telangana State



# VIGNAN'S INSTITUTE OF MANAGEMENT AND TECHNOLOGY FOR WOMEN

Sponsored by Laxmi Educational Society, Approved by AICTE, New Delhi & Affiliated to JNTU, Hyderabad.  
Kondapur (V), Ghatkesar (M), Medchal - Malkajgiri (D) - 501 301 TS INDIA  
Phone: +08615 200066/07/08 Email: info@vnmbe.in

## DEPARTMENT OF ELECTRONICS AND COMMUNICATION ENGINEERING

ADD ON COURSE NAME: Design and FPGA Implementation of DSP Processor using Verilog

Academic Year: 2018-19

Date: 18-09-2018

B.Tech IV-I SEM

DAY WISE ATTENDANCE SHEET

SECTION: ECE-A

S.No	Roll number	18-09-18	19-09-18	20-09-18	20-09-18	22-09-18
1.	15UPIA0401	Vaishu	Vaishu	Vaishu	Vaishu	Vaishu
2.	15UPIA0402	Vaishu	Vaishu	Vaishu	Vaishu	Vaishu
3.	15UPIA0403	Laxmi	Laxmi	Laxmi	Laxmi	Laxmi
4.	15UPIA0405	Pachar	Pachar	Pachar	Pachar	Pachar
5.	15UPIA0406	Ranya	Ranya	Ranya	Ranya	Ranya
6.	15UPIA0407	Anjali	Anjali	Anjali	Anjali	Anjali
7.	15UPIA0408	Kesathi	Kesathi	Kesathi	Kesathi	Kesathi
8.	15UPIA0409	Poothi	Poothi	Poothi	Poothi	Poothi
9.	15UPIA0410	Alekhy	Alekhy	Alekhy	Alekhy	Alekhy
10.	15UPIA0411	Poivankka	Poivankka	Poivankka	Poivankka	Poivankka
11.	15UPIA0412	Vyshnavi	Vyshnavi	Vyshnavi	Vyshnavi	Vyshnavi
12.	15UPIA0414	Hiraya	Hiraya	Hiraya	Hiraya	Hiraya
13.	15UPIA0415	Morika	Morika	Morika	Morika	Morika
14.	15UPIA0416	Devika	Devika	Devika	Devika	Devika
15.	15UPIA0417	Sravani	Sravani	Sravani	Sravani	Sravani
16.	15UPIA0418	Harpriya	Harpriya	Harpriya	Harpriya	Harpriya
17.	15UPIA0419	Pranaya	Pranaya	Pranaya	Pranaya	Pranaya
18.	15UPIA0420	Tejasvi	Tejasvi	Tejasvi	Tejasvi	Tejasvi
19.	15UPIA0421	Nikitha	Nikitha	Nikitha	Nikitha	Nikitha
20.	15UPIA0422	Uma	Uma	Uma	Uma	Uma
21.	15UPIA0423	Prathyusha	Prathyusha	Prathyusha	Prathyusha	Prathyusha
22.	15UPIA0424	Sai kanya	Sai kanya	Sai kanya	Sai kanya	Sai kanya
23.	15UPIA0425	K.sonia	K.sonia	K.sonia	K.sonia	K.sonia
24.	15UPIA0426	Vidya	Vidya	Vidya	Vidya	Vidya
25.	15UPIA0427	Nikhitha	Nikhitha	Nikhitha	Nikhitha	Nikhitha
26.	15UPIA0428	Mamatha	Mamatha	Mamatha	Mamatha	Mamatha
27.	15UPIA0429	Pallavi	Pallavi	Pallavi	Pallavi	Pallavi
28.	15UPIA0430	Kavita	Kavita	Kavita	Kavita	Kavita
29.	15UPIA0431	Vikasini	Vikasini	Vikasini	Vikasini	Vikasini
30.	15UPIA0432	Vikasini	Vikasini	Vikasini	Vikasini	Vikasini
31.	15UPIA0434	Kavya	Kavya	Kavya	Kavya	Kavya
32.	15UPIA0435	Bhavana	Bhavana	Bhavana	Bhavana	Bhavana
33.	15UPIA0436	Vidya	Vidya	Vidya	Vidya	Vidya



*[Signature]*  
PRINCIPAL

Vignans Institute of Management & Technology For Women  
Kondapur(V), Ghatkesar(M), Medchal-Malkajgiri(D)-501301  
Telangana State

34.	1SUP1A0437	Ranya	Ranya	Ranya	Ranya	Ranya
35.	1SUP1A0438	Varsha	Varsha	Varsha	Varsha	Varsha
36.	1SUP1A0439	Varshini	Varshini	Varshini	Varshini	Varshini
37.	1SUP1A0440	Nandini	Nandini	Nandini	Nandini	Nandini
38.	1SUP1A0401	Meghana	Meghana	Meghana	Meghana	Meghana
39.	1SUP1A0402	Varsha	Varsha	Varsha	Varsha	Varsha
40.	1SUP1A0403	Prasanna	Prasanna	Prasanna	Prasanna	Prasanna

  
**COORDINATOR**

  
**ECE, HOD**

Head of the Department  
 Electronics and Communication Engineering  
 Women's Institute of Management and Technology for Women  
 Kondapur (V), Ghatakisar (M), R.R. Dist-501 301.



  
**PRINCIPAL**

Women's Institute of Management & Technology for Women  
 Kondapur (V), Ghatakisar (M), Medchal-Malkajgiri (D), TS.





# VIGNAN'S INSTITUTE OF MANAGEMENT AND TECHNOLOGY FOR WOMEN

Sponsored by Laxmi Educational Society, Approved by AICTE, New Delhi & Affiliated to JNTUH, Hyderabad.  
Kondapur (V), Ghatkesar (M), Medchal - Malkajgiri (D) - 501 301 TS INDIA  
Phone: +08615 200067/08 Email: info@vmbw.in

## DEPARTMENT OF ELECTRONICS AND COMMUNICATION ENGINEERING

ADD ON COURSE NAME: Design and FPGA Implementation of DSP Processor using Verilog

Academic Year: 2018-19

Date: 18-09-2018

B.Tech IV-I SEM

DAY WISE ATTENDANCE SHEET

SECTION: ECE-B

S.No	Roll number	18-09-18	19-09-18	20-09-18	20-09-18	22-09-18
1.	15UP1A0441	Swetha	Swetha	Swetha	Swetha	Swetha
2.	15UP1A0442	Archana	Archana	Archana	Archana	Archana
3.	15UP1A0443	Manan	Manan	Manan	Manan	Manan
4.	15UP1A0444	Keelthi	Keelthi	Keelthi	Keelthi	Keelthi
5.	15UP1A0445	Priyanka	Priyanka	Priyanka	Priyanka	Priyanka
6.	15UP1A0446	Manmatha	Manmatha	Manmatha	Manmatha	Manmatha
7.	15UP1A0447	Bhavathi	Bhavathi	Bhavathi	Bhavathi	Bhavathi
8.	15UP1A0448	Ravali	Ravali	Ravali	Ravali	Ravali
9.	15UP1A0449	Su	Su	Su	Su	Su
10.	15UP1A0450	Taruna	Taruna	Taruna	Taruna	Taruna
11.	15UP1A0451	Binikitha	Binikitha	Binikitha	Binikitha	Binikitha
12.	15UP1A0452	Aisha	Aisha	Aisha	Aisha	Aisha
13.	15UP1A0453	AD	AD	AD	AD	AD
14.	15UP1A0454	K. Ruj	K. Ruj	K. Ruj	K. Ruj	K. Ruj
15.	15UP1A0455	Nanya	Nanya	Nanya	Nanya	Nanya
16.	15UP1A0456	Saranya	Saranya	Saranya	Saranya	Saranya
17.	15UP1A0457	Harsha	Harsha	Harsha	Harsha	Harsha
18.	15UP1A0458	Nanya	Nanya	Nanya	Nanya	Nanya
19.	15UP1A0459	Pooja	Pooja	Pooja	Pooja	Pooja
20.	15UP1A0460	Sirija	Sirija	Sirija	Sirija	Sirija
21.	15UP1A0461	Lavanya	Lavanya	Lavanya	Lavanya	Lavanya
22.	15UP1A0462	Chandana	Chandana	Chandana	Chandana	Chandana
23.	15UP1A0463	It	It	It	It	It
24.	15UP1A0464	shivaPriya	shivaPriya	shivaPriya	shivaPriya	shivaPriya
25.	15UP1A0465	Pravalka	Pravalka	Pravalka	Pravalka	Pravalka
26.	15UP1A0466	Sravanthi	Sravanthi	Sravanthi	Sravanthi	Sravanthi
27.	15UP1A0467	M. Yas	M. Yas	M. Yas	M. Yas	M. Yas
28.	15UP1A0468	Anusha	Anusha	Anusha	Anusha	Anusha
29.	15UP1A0469	Veda	Veda	Veda	Veda	Veda
30.	15UP1A0470	Yash	Yash	Yash	Yash	Yash
31.	15UP1A0472	pritya	pritya	pritya	pritya	pritya
32.	15UP1A0473	Manasa	Manasa	Manasa	Manasa	Manasa
33.	15UP1A0474	Nikitha	Nikitha	Nikitha	Nikitha	Nikitha



*[Signature]*  
PRINCIPAL

Vignans Institute of Management & Technology For Women  
Kondapur(V), Ghatkesar(M), Medchal-Malkajgiri(D)-501301  
Telangana State

34.	15UPIA0475	A.priyanka	A.priyanka	A.priyanka	A.priyanka	A.priyanka
35.	15UPIA0476	Nikitha	Nikitha	Nikitha	Nikitha	Nikitha
36.	15UPIA0477	Kalyani	Kalyani	Kalyani	Kalyani	Kalyani
37.	15UPIA0478	Mahathi	Mahathi	Mahathi	Mahathi	Mahathi
38.	15UPIA0479	Nirisha	Nirisha	Nirisha	Nirisha	Nirisha
39.	15UPIA0480	Y.Duf	Y.Duf	Y.Duf	Y.Duf	Y.Duf

  
COORDINATOR

  
ECE, HOD

Head of the Department  
Electronics and Communication Engineering  
Vignans Institute of Management and Technology for Women  
Kondapur (V), Ghatkesar (M), R.R. Dist-501301



  
PRINCIPAL  
Vignans Institute of Management & Technology For Women  
Kondapur(V), Ghatkesar(M), Medchal-Malkajgiri(Dist)-501301  
- Telangana State -



# VIGNAN'S INSTITUTE OF MANAGEMENT AND TECHNOLOGY FOR WOMEN

Sponsored by Laxmi Educational Society, Approved by AICTE, New Delhi & Affiliated to JNTU, Hyderabad.  
Kondapur (V), Ghatkesar (M), Medchal - Malkajgiri (D) - 501 301 TS INDIA  
Phone: +08515 200005/07/08 Email: info@vmtw.in

## DEPARTMENT OF ELECTRONICS AND COMMUNICATION ENGINEERING

ADD ON COURSE NAME: Design and FPGA Implementation of DSP Processor using Verilog

Academic Year: 2018-19

Date: 24-09-2018

B.Tech IV-I SEM

DAY WISE ATTENDANCE SHEET

SECTION: ECE-A

S.No	Roll number	24-09-18	25-09-18	26-09-18	27-09-18	28-09-18
1.	15UPIA0401	Vaibha	Vaibha	Vaibha	Vaibha	Vaibha
2.	15UPIA0402	Vaibha	Vaibha	Vaibha	Vaibha	Vaibha
3.	15UPIA0403	Laxmi	Laxmi	Laxmi	Laxmi	Laxmi
4.	15UPIA0405	Pooja	Pooja	Pooja	Pooja	Pooja
5.	15UPIA0406	Ranya	Ranya	Ranya	Ranya	Ranya
6.	15UPIA0407	Arjuni	Arjuni	Arjuni	Arjuni	Arjuni
7.	15UPIA0408	Kaushik	Kaushik	Kaushik	Kaushik	Kaushik
8.	15UPIA0409	Prachi	Prachi	Prachi	Prachi	Prachi
9.	15UPIA0410	Alekha	Alekha	Alekha	Alekha	Alekha
10.	15UPIA0411	Priyanka	Priyanka	Priyanka	Priyanka	Priyanka
11.	15UPIA0412	Vishnavi	Vishnavi	Vishnavi	Vishnavi	Vishnavi
12.	15UPIA0414	Himaja	Himaja	Himaja	Himaja	Himaja
13.	15UPIA0415	Mansi	Mansi	Mansi	Mansi	Mansi
14.	15UPIA0416	Devika	Devika	Devika	Devika	Devika
15.	15UPIA0417	Sravani	Sravani	Sravani	Sravani	Sravani
16.	15UPIA0418	Harpriya	Harpriya	Harpriya	Harpriya	Harpriya
17.	15UPIA0419	Pranya	Pranya	Pranya	Pranya	Pranya
18.	15UPIA0420	Tejasvi	Tejasvi	Tejasvi	Tejasvi	Tejasvi
19.	15UPIA0421	Nikita	Nikita	Nikita	Nikita	Nikita
20.	15UPIA0422	Uma	Uma	Uma	Uma	Uma
21.	15UPIA0423	Prathista	Prathista	Prathista	Prathista	Prathista
22.	15UPIA0424	Sai Krupa	Sai Krupa	Sai Krupa	Sai Krupa	Sai Krupa
23.	15UPIA0425	K.Sonia	K.Sonia	K.Sonia	K.Sonia	K.Sonia
24.	15UPIA0426	Vijetha	Vijetha	Vijetha	Vijetha	Vijetha
25.	15UPIA0427	Nikita	Nikita	Nikita	Nikita	Nikita
26.	15UPIA0428	Mamatha	Mamatha	Mamatha	Mamatha	Mamatha
27.	15UPIA0429	Pallavi	Pallavi	Pallavi	Pallavi	Pallavi
28.	15UPIA0430	Kavari	Kavari	Kavari	Kavari	Kavari
29.	15UPIA0431	Likhitha	Likhitha	Likhitha	Likhitha	Likhitha
30.	15UPIA0432	Vikasini	Vikasini	Vikasini	Vikasini	Vikasini
31.	15UPIA0434	Kavya	Kavya	Kavya	Kavya	Kavya
32.	15UPIA0435	Bhavana	Bhavana	Bhavana	Bhavana	Bhavana
33.	15UPIA0436	Vidya	Vidya	Vidya	Vidya	Vidya
34.	15UPIA0437	Ranya	Ranya	Ranya	Ranya	Ranya



PRINCIPAL  
Vignans Institute of Management & Technology for Women  
Kondapur(V), Ghatkesar(M), Medchal-Malkajgiri(D)-501301  
Telangana State

35.	15UPIA0438	Vaishvi	Vaishvi	Vaishvi	Vaishvi	Vaishvi
36.	15UPIA0439	Varshini	Varshini	Varshini	Varshini	Varshini
37.	15UPIA0440	Nandini	Nandini	Nandini	Nandini	Nandini
38.	15UPIA0401	Meghna	Meghna	Meghna	Meghna	Meghna
39.	15UPIA0402	Vaishvi	Vaishvi	Vaishvi	Vaishvi	Vaishvi
40.	15UPIA0403	prashant	prashant	prashant	prashant	prashant

  
**COORDINATOR**

  
**ECE, HOD**

Head of the Department  
 Electronics and Communication Engineering  
 Vigyan's Institute of Management & Technology for Women  
 Kondapur (V), Ghatkesar (M), R. N. Dist-501301



  
**PRINCIPAL**  
 Vigyan's Institute of Management & Technology for Women  
 Kondapur(V), Ghatkesar(M), Medchal-Malkajgiri(DI)-501301  
 Telangana State



# VIGNAN'S INSTITUTE OF MANAGEMENT AND TECHNOLOGY FOR WOMEN

Sponsored by Laxmi Educational Society, Approved by AICTE, New Delhi & Affiliated to JNTU, Hyderabad.  
Kondapur (V), Ghatkesar (M), Medchal - Malkajgiri (D) - 501 301 TS INDIA  
Phone: +08615 200006/07/08 Email: info@vmtw.in

## DEPARTMENT OF ELECTRONICS AND COMMUNICATION ENGINEERING

ADD ON COURSE NAME: Design and FPGA Implementation of DSP Processor using Verilog

Academic Year: 2018-19

Date: 24-09-2018

B.Tech IV-I SEM

DAY WISE ATTENDANCE SHEET

SECTION: ECE-B

S.No	Roll number	24-09-18	25-09-18	26-09-18	27-09-18	28-09-18
1.	15UP1A0441	Swetha	Swetha	Swetha	Swetha	Swetha
2.	15UP1A0442	Archana	Archana	Archana	Archana	Archana
3.	15UP1A0443	Manasa	Manasa	Manasa	Manasa	Manasa
4.	15UP1A0444	Keerthi	Keerthi	Keerthi	Keerthi	Keerthi
5.	15UP1A0445	Priyanka	Priyanka	Priyanka	Priyanka	Priyanka
6.	15UP1A0446	Mamatha	Mamatha	Mamatha	Mamatha	Mamatha
7.	15UP1A0447	Bhavana	Bhavana	Bhavana	Bhavana	Bhavana
8.	15UP1A0448	Ravali	Ravali	Ravali	Ravali	Ravali
9.	15UP1A0449	Sru	Sru	Sru	Sru	Sru
10.	15UP1A0450	Jashna	Jashna	Jashna	Jashna	Jashna
11.	15UP1A0451	Snikitha	Snikitha	Snikitha	Snikitha	Snikitha
12.	15UP1A0452	Snicha	Snicha	Snicha	Snicha	Snicha
13.	15UP1A0453	Adi	Adi	Adi	Adi	Adi
14.	15UP1A0454	K.Priy	K.Priy	K.Priy	K.Priy	K.Priy
15.	15UP1A0455	Kavya	Kavya	Kavya	Kavya	Kavya
16.	15UP1A0456	Sanvya	Sanvya	Sanvya	Sanvya	Sanvya
17.	15UP1A0457	Harsha	Harsha	Harsha	Harsha	Harsha
18.	15UP1A0458	Nanya	Nanya	Nanya	Nanya	Nanya
19.	15UP1A0459	Pooja	Pooja	Pooja	Pooja	Pooja
20.	15UP1A0460	Srinja	Srinja	Srinja	Srinja	Srinja
21.	15UP1A0461	Lavanya	Lavanya	Lavanya	Lavanya	Lavanya
22.	15UP1A0462	Chandana	Chandana	Chandana	Chandana	Chandana
23.	15UP1A0463	St	St	St	St	St
24.	15UP1A0464	Shivapriya	Shivapriya	Shivapriya	Shivapriya	Shivapriya
25.	15UP1A0465	Pravata	Pravata	Pravata	Pravata	Pravata
26.	15UP1A0466	Srawanthi	Srawanthi	Srawanthi	Srawanthi	Srawanthi
27.	15UP1A0467	M.Yash	M.Yash	M.Yash	M.Yash	M.Yash
28.	15UP1A0468	Shrusha	Shrusha	Shrusha	Shrusha	Shrusha
29.	15UP1A0469	Veda	Veda	Veda	Veda	Veda
30.	15UP1A0470	Yash	Yash	Yash	Yash	Yash
31.	15UP1A0472	Pritya	Pritya	Pritya	Pritya	Pritya
32.	15UP1A0473	Manasa	Manasa	Manasa	Manasa	Manasa
33.	15UP1A0474	Nikitha	Nikitha	Nikitha	Nikitha	Nikitha
34.	15UP1A0475	Priyanka	Priyanka	Priyanka	Priyanka	Priyanka



*Vignani*  
PRINCIPAL

Vignani's Institute of Management & Technology For Women  
Kondapur(V), Ghatkesar(M), Medchal-Malkajgiri(D)-501301  
Telangana State

35.	15UP1A0476	Diksha	Diksha	Diksha	Diksha	Diksha
36.	15UP1A0477	Kalyani	Kalyani	Kalyani	Kalyani	Kalyani
37.	15UP1A0478	Mahesh	Mahesh	Mahesh	Mahesh	Mahesh
38.	15UP1A0479	Manisha	Manisha	Manisha	Manisha	Manisha
39.	15UP1A0480	Y. Puf	Y. Puf	Y. Puf	Y. Puf	Y. Puf

  
**COORDINATOR**

  
**ECE, HOD**

Head of the Department  
 Electronics and Communication Engineering  
 Vignana Institute of Management and Technology For Women  
 Kondapur (V), Ghatkesar (M), R.R. Dist-501 301



  
**PRINCIPAL**  
 Vignana Institute of Management & Technology For Women  
 Kondapur(V), Ghatkesar(M), Medchal-Malkajgiri(Dt)-501 301  
 Telangana State



# VIGNAN'S INSTITUTE OF MANAGEMENT AND TECHNOLOGY FOR WOMEN

Sponsored by Laxmi Educational Society, Approved by AICTE, New Delhi & Affiliated to JNTU, Hyderabad.  
Kondapur (V), Ghatkesar (M), Medchal - Malkajgiri (D) - 501 301 TS INDIA.  
Phone: +09015 200060/7/08 Email: info@vmtw.in

## DEPARTMENT OF ELECTRONICS AND COMMUNICATION ENGINEERING

ADD ON COURSE NAME: Design and FPGA Implementation of DSP Processor using Verilog

Academic Year: 2018-19

Date: 29-09-2018

B.Tech IV-I SEM

DAY WISE ATTENDANCE SHEET

SECTION: ECE-A

S.No	Roll number	29-09-18	01-10-18	03-10-18	04-10-18	05-10-18
1.	15UPIA0401	Kalyani	Kalyani	Kalyani	Kalyani	Kalyani
2.	15UPIA0402	Vaishali	Vaishali	Vaishali	Vaishali	Vaishali
3.	15UPIA0403	Laxmi	Laxmi	Laxmi	Laxmi	Laxmi
4.	15UPIA0405	Pooja	Pooja	Pooja	Pooja	Pooja
5.	15UPIA0406	Ramya	Ramya	Ramya	Ramya	Ramya
6.	15UPIA0407	Arjuni	Arjuni	Arjuni	Arjuni	Arjuni
7.	15UPIA0408	Keerthi	Keerthi	Keerthi	Keerthi	Keerthi
8.	15UPIA0409	Pooja	Pooja	Pooja	Pooja	Pooja
9.	15UPIA0410	Alekhyas	Alekhyas	Alekhyas	Alekhyas	Alekhyas
10.	15UPIA0411	Priyanka	Priyanka	Priyanka	Priyanka	Priyanka
11.	15UPIA0412	Vishruti	Vishruti	Vishruti	Vishruti	Vishruti
12.	15UPIA0414	Himaja	Himaja	Himaja	Himaja	Himaja
13.	15UPIA0415	Manika	Manika	Manika	Manika	Manika
14.	15UPIA0416	Devika	Devika	Devika	Devika	Devika
15.	15UPIA0417	Shravan	Shravan	Shravan	Shravan	Shravan
16.	15UPIA0418	Harpita	Harpita	Harpita	Harpita	Harpita
17.	15UPIA0419	Pranaya	Pranaya	Pranaya	Pranaya	Pranaya
18.	15UPIA0420	Tejasvi	Tejasvi	Tejasvi	Tejasvi	Tejasvi
19.	15UPIA0421	Nikitha	Nikitha	Nikitha	Nikitha	Nikitha
20.	15UPIA0422	Uma	Uma	Uma	Uma	Uma
21.	15UPIA0423	Prathyusha	Prathyusha	Prathyusha	Prathyusha	Prathyusha
22.	15UPIA0424	Sai Krupa	Sai Krupa	Sai Krupa	Sai Krupa	Sai Krupa
23.	15UPIA0425	K. Sopia	K. Sopia	K. Sopia	K. Sopia	K. Sopia
24.	15UPIA0426	Vijay	Vijay	Vijay	Vijay	Vijay
25.	15UPIA0427	Nikhitha	Nikhitha	Nikhitha	Nikhitha	Nikhitha
26.	15UPIA0428	Mamatha	Mamatha	Mamatha	Mamatha	Mamatha
27.	15UPIA0429	Pallavi	Pallavi	Pallavi	Pallavi	Pallavi
28.	15UPIA0430	Kavya	Kavya	Kavya	Kavya	Kavya
29.	15UPIA0431	Ushat	Ushat	Ushat	Ushat	Ushat
30.	15UPIA0432	Vikasini	Vikasini	Vikasini	Vikasini	Vikasini
31.	15UPIA0434	Kavya	Kavya	Kavya	Kavya	Kavya
32.	15UPIA0435	Bhavana	Bhavana	Bhavana	Bhavana	Bhavana
33.	15UPIA0436	Vidya	Vidya	Vidya	Vidya	Vidya
34.	15UPIA0437	Ramya	Ramya	Ramya	Ramya	Ramya



*[Signature]*  
PRINCIPAL

Vignans Institute of Management & Technology For Women  
Kondapur (V), Ghatkesar (M), Medchal - Malkajgiri (D)

35.	15UP1A0438	Vaishiki	Vaishiki	Vaishiki	Vaishiki	Vaishiki
36.	15UP1A0439	Varshini	Varshini	Varshini	Varshini	Varshini
37.	15UP1A0440	Nandini	Nandini	Nandini	Nandini	Nandini
38.	15UP1A0401	Meghana	Meghana	Meghana	Meghana	Meghana
39.	15UP1A0402	Vaishya	Vaishya	Vaishya	Vaishya	Vaishya
40.	15UP1A0403	Prasanna	Prasanna	Prasanna	Prasanna	Prasanna

  
COORDINATOR

  
ECE, HOD

Head of the Department  
Electronics and Communication Engineering  
Srijan's Institute of Management and Technology For Women  
Kondapur (V), Ghatekar (M), Medchal-Nalgonda (Dist)-501301  
Telangana State



  
PRINCIPAL  
Srijan's Institute of Management & Technology For Women  
Kondapur (V), Ghatekar (M), Medchal-Nalgonda (Dist)-501301  
Telangana State





# VIGNAN'S INSTITUTE OF MANAGEMENT AND TECHNOLOGY FOR WOMEN

Sponsored by Levy Educational Society, Approved by AICTE, New Delhi & Affiliated to JNTUH, Hyderabad.  
Kondapur (V), Ghatkesar (M), Medchal - Malkajgiri (D) - 501 301 TS INDIA  
Phone: +09515 200006/07/08 Email: info@vmbw.in

## DEPARTMENT OF ELECTRONICS AND COMMUNICATION ENGINEERING

ADD ON COURSE NAME: Design and FPGA Implementation of DSP Processor using Verilog

Academic Year: 2018-19

Date: 29-09-2018

B.Tech IV-I SEM

DAY WISE ATTENDANCE SHEET

SECTION: ECE-B

S.No	Roll number	29-09-18	01-10-18	03-10-18	04-10-18	05-10-18
1.	15UPIA0441	Swetha	Swetha	Swetha	Swetha	Swetha
2.	15UPIA0442	Archana	Archana	Archana	Archana	Archana
3.	15UPIA0443	Manan	Manan	Manan	Manan	Manan
4.	15UPIA0444	Keerthi	Keerthi	Keerthi	Keerthi	Keerthi
5.	15UPIA0445	Priyanka	Priyanka	Priyanka	Priyanka	Priyanka
6.	15UPIA0446	Mamatha	Mamatha	Mamatha	Mamatha	Mamatha
7.	15UPIA0447	Bhawalika	Bhawalika	Bhawalika	Bhawalika	Bhawalika
8.	15UPIA0448	Ravali	Ravali	Ravali	Ravali	Ravali
9.	15UPIA0449	Su	Su	Su	Su	Ravali
10.	15UPIA0450	Joshna	Joshna	Joshna	Joshna	Joshna
11.	15UPIA0451	G. Nikitha	G. Nikitha	G. Nikitha	G. Nikitha	G. Nikitha
12.	15UPIA0452	Sristha	Sristha	Sristha	Sristha	Sristha
13.	15UPIA0453					
14.	15UPIA0454	K. Rud	K. Rud	K. Rud	K. Rud	K. Rud
15.	15UPIA0455	Kavya	Kavya	Kavya	Kavya	Kavya
16.	15UPIA0456	Sravya	Sravya	Sravya	Sravya	Sravya
17.	15UPIA0457	Harsha	Harsha	Harsha	Harsha	Harsha
18.	15UPIA0458	Navya	Navya	Navya	Navya	Navya
19.	15UPIA0459	Pooja	Pooja	Pooja	Pooja	Pooja
20.	15UPIA0460	Srija	Srija	Srija	Srija	Srija
21.	15UPIA0461	Lavanya	Lavanya	Lavanya	Lavanya	Lavanya
22.	15UPIA0462	Chandana	Chandana	Chandana	Chandana	Chandana
23.	15UPIA0463	Pr	Pr	Pr	Pr	Pr
24.	15UPIA0464	Shivapriya	Shivapriya	Shivapriya	Shivapriya	Shivapriya
25.	15UPIA0465	Pravalika	Pravalika	Pravalika	Pravalika	Pravalika
26.	15UPIA0466	Sravanthi	Sravanthi	Sravanthi	Sravanthi	Sravanthi
27.	15UPIA0467	M. Yas	M. Yas	M. Yas	M. Yas	M. Yas
28.	15UPIA0468	Shrusha	Shrusha	Shrusha	Shrusha	Shrusha
29.	15UPIA0469	Veda	Veda	Veda	Veda	Veda
30.	15UPIA0470	Yash	Yash	Yash	Yash	Yash
31.	15UPIA0472	Pritya	Pritya	Pritya	Pritya	Pritya
32.	15UPIA0473	Manasa	Manasa	Manasa	Manasa	Manasa
33.	15UPIA0474	Nikitha	Nikitha	Nikitha	Nikitha	Nikitha
34.	15UPIA0475	Priyanka	Priyanka	Priyanka	Priyanka	Priyanka



*ASJ*  
PRINCIPAL

Vignani's Institute of Management & Technology For Women  
Kondapur(V), Ghatkesar(M), Medchal-Malkajgiri(D)-501301  
Telangana State

35.	15UP1A0476	Nikitha	Nikitha	Nikitha	Nikitha	Nikitha
36.	15UP1A0477	Kalyani	Kalyani	Kalyani	Kalyani	Kalyani
37.	15UP1A0478	Mahalle	Mahalle	Mahalle	Mahalle	Mahalle
38.	15UP1A0479	Minisha	Minisha	Minisha	Minisha	Minisha
39.	15UP1A0480	Y. Eef	Y. Eef	Y. Eef	Y. Eef	Y. Eef

  
COORDINATOR

  
ECE, HOD

Head of the Department  
Electronics and Communication Engineering  
Sivan's Institute of Management & Technology For Women  
Kondapur (V), Ghatskesar (M), Pin-551301  
Telangana State



  
PRINCIPAL  
Sivan's Institute of Management & Technology For Women  
Kondapur (V), Ghatskesar (M), Medchal-Malkajgiri (D), Pin-551301  
Telangana State



# VIGNAN'S INSTITUTE OF MANAGEMENT AND TECHNOLOGY FOR WOMEN

Sponsored by Jyvu Educational Society, Approved by AICTE, New Delhi & Affiliated to JNTU, Hyderabad.  
Kondapur (V), Ghatkesar (M), Medchal - Malkajgiri (D) - 501 301 TS INDIA  
Phone: +0865 200060/07/08 Email: info@vmtw.in

## DEPARTMENT OF ELECTRONICS AND COMMUNICATION ENGINEERING

ADD ON COURSE NAME: Design and FPGA Implementation of DSP Processor using Verilog

Academic Year: 2018-19

Date: 06-10-2018

B.Tech IV-I SEM

DAY WISE ATTENDANCE SHEET

SECTION: ECE-A

S.No	Roll number	06-10-18	08-10-18	09-10-18	10-10-18	11-10-18
1.	15UP1A0401	vaiba	vaiba	vaiba	vaiba	vaiba
2.	15UP1A0402	vaiba	vaiba	vaiba	vaiba	vaiba
3.	15UP1A0403	Laani	Laani	Laani	Laani	Laani
4.	15UP1A0405	Rachana	Rachana	Rachana	Rachana	Rachana
5.	15UP1A0406	Pamya	Pamya	Pamya	Pamya	Pamya
6.	15UP1A0407	Arjuni	Arjuni	Arjuni	Arjuni	Arjuni
7.	15UP1A0408	keethi	keethi	keethi	keethi	keethi
8.	15UP1A0409	Prathi	Prathi	Prathi	Prathi	Prathi
9.	15UP1A0410	Alekha	Alekha	Alekha	Alekha	Alekha
10.	15UP1A0411	Priyanka	Priyanka	Priyanka	Priyanka	Priyanka
11.	15UP1A0412	vishruti	vishruti	vishruti	vishruti	vishruti
12.	15UP1A0414	Himaja	Himaja	Himaja	Himaja	Himaja
13.	15UP1A0415	Manika	Manika	Manika	Manika	Manika
14.	15UP1A0416	Devika	Devika	Devika	Devika	Devika
15.	15UP1A0417	Sravani	Sravani	Sravani	Sravani	Sravani
16.	15UP1A0418	Harpriya	Harpriya	Harpriya	Harpriya	Harpriya
17.	15UP1A0419	Pranaya	Pranaya	Pranaya	Pranaya	Pranaya
18.	15UP1A0420	Tejasvi	Tejasvi	Tejasvi	Tejasvi	Tejasvi
19.	15UP1A0421	Nishita	Nishita	Nishita	Nishita	Nishita
20.	15UP1A0422	Uma	Uma	Uma	Uma	Uma
21.	15UP1A0423	Prathista	Prathista	Prathista	Prathista	Prathista
22.	15UP1A0424	Sai Krishna	Sai Krishna	Sai Krishna	Sai Krishna	Sai Krishna
23.	15UP1A0425	K.Sonia	K.Sonia	K.Sonia	K.Sonia	K.Sonia
24.	15UP1A0426	Vijf	Vijf	Vijf	Vijf	Vijf
25.	15UP1A0427	Nishitha	Nishitha	Nishitha	Nishitha	Nishitha
26.	15UP1A0428	Mamatha	Mamatha	Mamatha	Mamatha	Mamatha
27.	15UP1A0429	Pallavi	Pallavi	Pallavi	Pallavi	Pallavi
28.	15UP1A0430	Kavani	Kavani	Kavani	Kavani	Kavani
29.	15UP1A0431	Lakshmi	Lakshmi	Lakshmi	Lakshmi	Lakshmi
30.	15UP1A0432	Vikasini	Vikasini	Vikasini	Vikasini	Vikasini
31.	15UP1A0434	Kavya	Kavya	Kavya	Kavya	Kavya
32.	15UP1A0435	Bhavana	Bhavana	Bhavana	Bhavana	Bhavana
33.	15UP1A0436	Vidya	Vidya	Vidya	Vidya	Vidya



PRINCIPAL

Vignans Institute of Management & Technology for Women  
Kondapur(V), Ghatkesar(M), Medchal-Malkajgiri(D)-501301  
Telangana State

34.	15UPIA0437	Ranya	Ranya	Ranya	Ranya	Ranya
35.	15UPIA0438	Vaithi	Vaithi	Vaithi	Vaithi	Vaithi
36.	15UPIA0439	Varchini	Varchini	Varchini	Varchini	Varchini
37.	15UPIA0440	Nandini	Nandini	Nandini	Nandini	Nandini
38.	15UPIA0401	Meghana	Meghana	Meghana	Meghana	Meghana
39.	15UPIA0402	Vaishya	Vaishya	Vaishya	Vaishya	Vaishya
40.	15UPIA0403	Prasanna	Prasanna	Prasanna	Prasanna	Prasanna

  
COORDINATOR

  
ECE, HOD

Head of the Department  
Electronics and Communication Engineering  
Srijan's Institute of Management and Technology For Women  
Kondapur (V), Ghatkesar (M), Medchal-Malkajgiri (Dt), 501301



  
PRINCIPAL  
Srijan's Institute of Management & Technology For Women  
Kondapur(V), Ghatkesar(M), Medchal-Malkajgiri(Dt), 501301  
Telangana State



# VIGNAN'S INSTITUTE OF MANAGEMENT AND TECHNOLOGY FOR WOMEN

Sponsored by Law Education Society, Approved by AICTE, New Delhi & Affiliated to JNTU, Hyderabad.  
Kondapur (V), Ghatkesar (M), Medchal - Malkajgiri (D) - 501 301 TS INDIA  
Phone: +08615 20006/07/08 Email: info@vignans.in

## DEPARTMENT OF ELECTRONICS AND COMMUNICATION ENGINEERING

ADD ON COURSE NAME: Design and FPGA Implementation of DSP Processor using Verilog

Academic Year: 2018-19

Date: 06-10-2018

B.Tech IV-I SEM

DAY WISE ATTENDANCE SHEET

SECTION: ECE-B

S.No	Roll number	06-10-18	08-10-18	09-10-18	10-10-18	11-10-18
1.	15UPIA0441	Swetha	Swetha	Swetha	Swetha	Swetha
2.	15UPIA0442	Archana	Archana	Archana	Archana	Archana
3.	15UPIA0443	Manana	Manana	Manana	Manana	Manana
4.	15UPIA0444	Keelthi	Keelthi	Keelthi	Keelthi	Keelthi
5.	15UPIA0445	Priyanka	Priyanka	Priyanka	Priyanka	Priyanka
6.	15UPIA0446	Mananthe	Mananthe	Mananthe	Mananthe	Mananthe
7.	15UPIA0447	Bhawalthe	Bhawalthe	Bhawalthe	Bhawalthe	Bhawalthe
8.	15UPIA0448	Ravali	Ravali	Ravali	Ravali	Ravali
9.	15UPIA0449	Sw	Sw	Sw	Sw	Sw
10.	15UPIA0450	Joshna	Joshna	Joshna	Joshna	Joshna
11.	15UPIA0451	G.Nikithe	G.Nikithe	G.Nikithe	G.Nikithe	G.Nikithe
12.	15UPIA0452	Prisha	Prisha	Prisha	Prisha	Prisha
13.	15UPIA0453	Pa	Pa	Pa	Pa	Pa
14.	15UPIA0454	K.Pul	K.Pul	K.Pul	K.Pul	K.Pul
15.	15UPIA0455	Kavya	Kavya	Kavya	Kavya	Kavya
16.	15UPIA0456	Caavya	Caavya	Caavya	Caavya	Caavya
17.	15UPIA0457	Harsha	Harsha	Harsha	Harsha	Harsha
18.	15UPIA0458	Navya	Navya	Navya	Navya	Navya
19.	15UPIA0459	Pul	Pul	Pul	Pul	Pul
20.	15UPIA0460	Sirija	Sirija	Sirija	Sirija	Sirija
21.	15UPIA0461	Laxya	Laxya	Laxya	Laxya	Laxya
22.	15UPIA0462	Chandana	Chandana	Chandana	Chandana	Chandana
23.	15UPIA0463	It	It	It	It	It
24.	15UPIA0464	shivaPriya	shivaPriya	shivaPriya	shivaPriya	shivaPriya
25.	15UPIA0465	Pravalika	Pravalika	Pravalika	Pravalika	Pravalika
26.	15UPIA0466	Savanthi	Savanthi	Savanthi	Savanthi	Savanthi
27.	15UPIA0467	M.Yas	M.Yas	M.Yas	M.Yas	M.Yas
28.	15UPIA0468	Anusha	Anusha	Anusha	Anusha	Anusha
29.	15UPIA0469	Veda	Veda	Veda	Veda	Veda
30.	15UPIA0470	Yash	Yash	Yash	Yash	Yash
31.	15UPIA0472	piya	piya	piya	piya	piya
32.	15UPIA0473	Manasa	Manasa	Manasa	Manasa	Manasa
33.	15UPIA0474	Nikithe	Nikithe	Nikithe	Nikithe	Nikithe



*Adi*  
PRINCIPAL

Vignans Institute of Management & Technology For Women  
Kondapur(V), Ghatkesar(M), Medchal-Malkajgiri(D)-501301  
Telangana State

34.	15UPIA0475	S. Prityakta	S. Prityakta	S. Prityakta	S. Prityakta	S. Prityakta
35.	15UPIA0476	N. Kitha	N. Kitha	N. Kitha	N. Kitha	N. Kitha
36.	15UPIA0477	Kalyani	Kalyani	Kalyani	Kalyani	Kalyani
37.	15UPIA0478	Mahesh	Mahesh	Mahesh	Mahesh	Mahesh
38.	15UPIA0479	Minisha	Minisha	Minisha	Minisha	Minisha
39.	15UPIA0480	Y. Prof	Y. Prof	Y. Prof	Y. Prof	Y. Prof

  
COORDINATOR

  
ECE, HOD

Head of the Department  
Electronics and Communication Engineering  
Vignas's Institute of Management and Technology For Women  
Kondapur (V), Ghaffarasar (M), Medchal-Malkajgiri (Dt)-501301



  
PRINCIPAL  
Vignas's Institute of Management & Technology For Women  
Kondapur(V), Ghaffarasar(M), Medchal-Malkajgiri(Dt)-501301  
Telangana State



# VIGNAN'S INSTITUTE OF MANAGEMENT AND TECHNOLOGY FOR WOMEN

Sponsored by Law Educational Society, Approved by AICTE, New Delhi & Affiliated to JNTU, Hyderabad  
Kondapur (V), Ghatkesar (M), Medchal - Malajigiri (D) - 501 301 TS INDIA  
Phone: +08615 20006/07/08 Email: info@vignans.edu

## DEPARTMENT OF ELECTRONICS AND COMMUNICATION ENGINEERING

ADD ON COURSE NAME: Design and FPGA Implementation of DSP Processor using Verilog

Academic Year: 2018-19

Date: 15-10-2018

B.Tech IV-I SEM

DAY WISE ATTENDANCE SHEET

SECTION: ECE-A

S.No	Roll number	15-10-18	16-10-18	20-10-18	22-10-18	23-10-18
1.	15UPIA0401	Varsha	Varsha	Varsha	Varsha	Varsha
2.	15UPIA0402	Varsha	Varsha	Varsha	Varsha	Varsha
3.	15UPIA0403	Laxmi	Laxmi	Laxmi	Laxmi	Laxmi
4.	15UPIA0405	Rachana	Rachana	Rachana	Rachana	Rachana
5.	15UPIA0406	Ramya	Ramya	Ramya	Ramya	Ramya
6.	15UPIA0407	Arjuni	Arjuni	Arjuni	Arjuni	Arjuni
7.	15UPIA0408	Kaushi	Kaushi	Kaushi	Kaushi	Kaushi
8.	15UPIA0409	Preethi	Preethi	Preethi	Preethi	Preethi
9.	15UPIA0410	Alekhyas	Alekhyas	Alekhyas	Alekhyas	Alekhyas
10.	15UPIA0411	Polyanka	Polyanka	Polyanka	Polyanka	Polyanka
11.	15UPIA0412	Vishnavi	Vishnavi	Vishnavi	Vishnavi	Vishnavi
12.	15UPIA0414	Himaja	Himaja	Himaja	Himaja	Himaja
13.	15UPIA0415	Manika	Manika	Manika	Manika	Manika
14.	15UPIA0416	Devika	Devika	Devika	Devika	Devika
15.	15UPIA0417	Sravani	Sravani	Sravani	Sravani	Sravani
16.	15UPIA0418	Harpriya	Harpriya	Harpriya	Harpriya	Harpriya
17.	15UPIA0419	Pranaya	Pranaya	Pranaya	Pranaya	Pranaya
18.	15UPIA0420	Tejasvi	Tejasvi	Tejasvi	Tejasvi	Tejasvi
19.	15UPIA0421	Nikitha	Nikitha	Nikitha	Nikitha	Nikitha
20.	15UPIA0422	Uma	Uma	Uma	Uma	Uma
21.	15UPIA0423	Prathyusha	Prathyusha	Prathyusha	Prathyusha	Prathyusha
22.	15UPIA0424	Sai Krupa	Sai Krupa	Sai Krupa	Sai Krupa	Sai Krupa
23.	15UPIA0425	K.Sonia	K.Sonia	K.Sonia	K.Sonia	K.Sonia
24.	15UPIA0426	Vijetha	Vijetha	Vijetha	Vijetha	Vijetha
25.	15UPIA0427	Nikhitha	Nikhitha	Nikhitha	Nikhitha	Nikhitha
26.	15UPIA0428	Mamatha	Mamatha	Mamatha	Mamatha	Mamatha
27.	15UPIA0429	Pallavi	Pallavi	Pallavi	Pallavi	Pallavi
28.	15UPIA0430	Kavani	Kavani	Kavani	Kavani	Kavani
29.	15UPIA0431	Hikanti	Hikanti	Hikanti	Hikanti	Hikanti
30.	15UPIA0432	Vikasini	Vikasini	Vikasini	Vikasini	Vikasini
31.	15UPIA0434	Kavya	Kavya	Kavya	Kavya	Kavya
32.	15UPIA0435	Bhavana	Bhavana	Bhavana	Bhavana	Bhavana



*[Signature]*  
PRINCIPAL

Vignans Institute of Management & Technology For Women  
Kondapur(V), Ghatkesar(M), Medchal-Malajigiri(D)-501301  
Telangana State

33.	15UPIA0436	Vidya	Vidya	Vidya	Vidya	Vidya
34.	15UPIA0437	Ranya	Ranya	Ranya	Ranya	Ranya
35.	15UPIA0438	Vaishya	Vaishya	Vaishya	Vaishya	Vaishya
36.	15UPIA0439	Varshini	Varshini	Varshini	Varshini	Varshini
37.	15UPIA0440	Nandini	Nandini	Nandini	Nandini	Nandini
38.	15UPIA0401	Meghana	Meghana	Meghana	Meghana	Meghana
39.	15UPIA0402	Vaibha	Vaibha	Vaibha	Vaibha	Vaibha
40.	15UPIA0403	Prasanna	Prasanna	Prasanna	Prasanna	Prasanna

  
COORDINATOR

  
ECE, HOD

Head of the Department  
Electronics and Communication Engineering  
Vigna's Institute of Management and Technology For Women  
Kondapur (V), Ghafkasan (M), R.R. Dist-501301



  
PRINCIPAL

Vigna's Institute of Management & Technology For Women  
Kondapur(V), Ghafkasan(M), Medchal-Malkajgiri(Dt)-501301  
Telangana State





# VIGNAN'S INSTITUTE OF MANAGEMENT AND TECHNOLOGY FOR WOMEN

[Sponsored by Lavu Educational Society, Approved by AICTE, New Delhi & Affiliated to JNTUH, Hyderabad.]

Kondapur (V), Ghatkesar (M), Medchal - Malkajgiri (D) - 501 301 TS INDIA

Phone: +08415 200006/07/08

Email: info.vmtw.in

## DEPARTMENT OF ELECTRONICS AND COMMUNICATION ENGINEERING

ADD ON COURSE NAME: Design and FPGA Implementation of DSP Processor using Verilog

Academic Year: 2018-19

Date: 15-10-2018

B.Tech IV-I SEM

DAY WISE ATTENDANCE SHEET

SECTION: ECE-B

S.No	Roll number	15-10-18	16-10-18	20-10-18	22-10-18	23-10-18
1.	15UP1A0441	Swetha	Swetha	Swetha	Swetha	Swetha
2.	15UP1A0442	Archana	Archana	Archana	Archana	Archana
3.	15UP1A0443	Manasa	Manasa	Manasa	Manasa	Manasa
4.	15UP1A0444	Keerthi	Keerthi	Keerthi	Keerthi	Keerthi
5.	15UP1A0445	Priyanka	Priyanka	Priyanka	Priyanka	Priyanka
6.	15UP1A0446	Manasika	Manasika	Manasika	Manasika	Manasika
7.	15UP1A0447	Bhargavi	Bhargavi	Bhargavi	Bhargavi	Bhargavi
8.	15UP1A0448	Ravali	Ravali	Ravali	Ravali	Ravali
9.	15UP1A0449	Siv	Siv	Siv	Siv	Siv
10.	15UP1A0450	Josha	Josha	Josha	Josha	Josha
11.	15UP1A0451	S. Nikitha	S. Nikitha	S. Nikitha	S. Nikitha	S. Nikitha
12.	15UP1A0452	Sristha	Sristha	Sristha	Sristha	Sristha
13.	15UP1A0453	Abhi	Abhi	Abhi	Abhi	Abhi
14.	15UP1A0454	K. P. P.	K. P. P.	K. P. P.	K. P. P.	K. P. P.
15.	15UP1A0455	Kavya	Kavya	Kavya	Kavya	Kavya
16.	15UP1A0456	Saranya	Saranya	Saranya	Saranya	Saranya
17.	15UP1A0457	Harsha	Harsha	Harsha	Harsha	Harsha
18.	15UP1A0458	Navya	Navya	Navya	Navya	Navya
19.	15UP1A0459	Pooja	Pooja	Pooja	Pooja	Pooja
20.	15UP1A0460	Sirija	Sirija	Sirija	Sirija	Sirija
21.	15UP1A0461	Lavanya	Lavanya	Lavanya	Lavanya	Lavanya
22.	15UP1A0462	Chandana	Chandana	Chandana	Chandana	Chandana
23.	15UP1A0463	A	A	A	A	A
24.	15UP1A0464	Shivapriya	Shivapriya	Shivapriya	Shivapriya	Shivapriya
25.	15UP1A0465	Pravalika	Pravalika	Pravalika	Pravalika	Pravalika
26.	15UP1A0466	Swarathi	Swarathi	Swarathi	Swarathi	Swarathi
27.	15UP1A0467	M. Yash	M. Yash	M. Yash	M. Yash	M. Yash
28.	15UP1A0468	Anusha	Anusha	Anusha	Anusha	Anusha
29.	15UP1A0469	Veda	Veda	Veda	Veda	Veda
30.	15UP1A0470	Yash	Yash	Yash	Yash	Yash
31.	15UP1A0472	Pritya	Pritya	Pritya	Pritya	Pritya
32.	15UP1A0473	Manasa	Manasa	Manasa	Manasa	Manasa
33.	15UP1A0474	Nikitha	Nikitha	Nikitha	Nikitha	Nikitha
34.	15UP1A0475	S. Priyanka	S. Priyanka	S. Priyanka	S. Priyanka	S. Priyanka



Principal  
Vignans Institute of Management & Technology for Women  
Kondapur(V), Ghatkesar(M), Medchal-Malkajgiri(D),  
Telangana State

35.	15UPIA0476	Nitha	Nitha	Nitha	Nitha	Nitha
36.	15UPIA0477	Kalyani	Kalyani	Kalyani	Kalyani	Kalyani
37.	15UPIA0478	Mahathi	Mahathi	Mahathi	Mahathi	Mahathi
38.	15UPIA0479	Minisha	Minisha	Minisha	Minisha	Minisha
39.	15UPIA0480	Y. Prof	Y. Prof	Y. Prof	Y. Prof	Y. Prof

  
COORDINATOR

  
ECE, HOD

Head of the Department  
Electronics and Communication Engineering  
Ignou's Institute of Management and Technology for Women  
Kondapur (V), Ghafkisar (M), R.R. Dist-501301



  
PRINCIPAL

Ignou's Institute of Management & Technology for Women  
Kondapur (V), Ghafkisar (M), Medchal-Malkajgiri (DT)-501301  
Telangana State



## VIGNAN'S INSTITUTE OF MANAGEMENT AND TECHNOLOGY FOR WOMEN

Sponsored by Law Educational Society, Approved by AICTE, New Delhi & Affiliated to JNTUH, Hyderabad.  
Kondapur (V), Ghatkesar (M), Medchal - Malkajgiri (D) - 501 301 TS INDIA  
Phone: +91915 200006/07/08 Email: info@vignans.in

### DEPARTMENT OF ELECTRONICS AND COMMUNICATION ENGINEERING

ADD ON COURSE NAME: Design and FPGA Implementation of DSP Processor using Verilog

Academic Year: 2018-19

Date: 24-10-2018

B.Tech IV-I SEM

DAY WISE ATTENDANCE SHEET

SECTION: ECE-A

S.No	Roll number	24-10-18	25-10-18	26-10-18	27-10-18	29-10-18
1.	15UPIA0401	Madhavi	Madhavi	Madhavi	Madhavi	Madhavi
2.	15UPIA0402	Vaishu	Vaishu	Vaishu	Vaishu	Vaishu
3.	15UPIA0403	Laxmi	Laxmi	Laxmi	Laxmi	Laxmi
4.	15UPIA0405	Rachana	Rachana	Rachana	Rachana	Rachana
5.	15UPIA0406	Ramya	Ramya	Ramya	Ramya	Ramya
6.	15UPIA0407	Anjali	Anjali	Anjali	Anjali	Anjali
7.	15UPIA0408	Keerthi	Keerthi	Keerthi	Keerthi	Keerthi
8.	15UPIA0409	Preeti	Preeti	Preeti	Preeti	Preeti
9.	15UPIA0410	Alekhyaa	Alekhyaa	Alekhyaa	Alekhyaa	Alekhyaa
10.	15UPIA0411	Priyanka	Priyanka	Priyanka	Priyanka	Priyanka
11.	15UPIA0412	Vyshnavi	Vyshnavi	Vyshnavi	Vyshnavi	Vyshnavi
12.	15UPIA0414	Himaja	Himaja	Himaja	Himaja	Himaja
13.	15UPIA0415	Manjitha	Manjitha	Manjitha	Manjitha	Manjitha
14.	15UPIA0416	Devika	Devika	Devika	Devika	Devika
15.	15UPIA0417	Sravani	Sravani	Sravani	Sravani	Sravani
16.	15UPIA0418	Harpriya	Harpriya	Harpriya	Harpriya	Harpriya
17.	15UPIA0419	Pranaya	Pranaya	Pranaya	Pranaya	Pranaya
18.	15UPIA0420	Tejasvi	Tejasvi	Tejasvi	Tejasvi	Tejasvi
19.	15UPIA0421	Nikitha	Nikitha	Nikitha	Nikitha	Nikitha
20.	15UPIA0422	Uma	Uma	Uma	Uma	Uma
21.	15UPIA0423	Priyanka	Priyanka	Priyanka	Priyanka	Priyanka
22.	15UPIA0424	Sai Krupa	Sai Krupa	Sai Krupa	Sai Krupa	Sai Krupa
23.	15UPIA0425	K. Sonia	K. Sonia	K. Sonia	K. Sonia	K. Sonia
24.	15UPIA0426	Vidit	Vidit	Vidit	Vidit	Vidit
25.	15UPIA0427	Nikhitha	Nikhitha	Nikhitha	Nikhitha	Nikhitha
26.	15UPIA0428	Mamatha	Mamatha	Mamatha	Mamatha	Mamatha
27.	15UPIA0429	Pallavi	Pallavi	Pallavi	Pallavi	Pallavi
28.	15UPIA0430	Kaveri	Kaveri	Kaveri	Kaveri	Kaveri
29.	15UPIA0431	Kavya	Kavya	Kavya	Kavya	Kavya
30.	15UPIA0432	Vikasini	Vikasini	Vikasini	Vikasini	Vikasini
31.	15UPIA0434	Kavya	Kavya	Kavya	Kavya	Kavya



*[Signature]*  
PRINCIPAL

Vignans Institute of Management & Technology for Women  
Kondapur(V), Ghatkesar(M), Medchal-Malkajgiri(D)-501301  
Telangana State

32.	15UPIA0435	Bhavana	Bhavana	Bhavana	Bhavana	Bhavana
33.	15UPIA0436	Vidya	Vidya	Vidya	Vidya	Vidya
34.	15UPIA0437	Danya	Danya	Danya	Danya	Danya
35.	15UPIA0438	Vaishvi	Vaishvi	Vaishvi	Vaishvi	Vaishvi
36.	15UPIA0439	Vaschini	Vaschini	Vaschini	Vaschini	Vaschini
37.	15UPIA0440	Nandini	Nandini	Nandini	Nandini	Nandini
38.	15UPIA0401	Meghna	Meghna	Meghna	Meghna	Meghna
39.	15UPIA0402	Valsha	Valsha	Valsha	Valsha	Valsha
40.	15UPIA0403	Prasanna	Prasanna	Prasanna	Prasanna	Prasanna

  
COORDINATOR

  
ECE, HOD

Head of the Department  
Electronics and Communication Engineering  
Vignana Institute of Management and Technology For Women  
Kondapur (V), Ghadkesar (M), Medchal-Malkajgiri (Dt)-501301



  
PRINCIPAL

Vignana Institute of Management & Technology For Women  
Kondapur(V), Ghadkesar(M), Medchal-Malkajgiri(Dt)-501301  
Telangana State



# VIGNAN'S INSTITUTE OF MANAGEMENT AND TECHNOLOGY FOR WOMEN

[Sponsored by Laxmi Educational Society, Approved by AICTE, New Delhi & Affiliated to JNTUW, Hyderabad.]

Kondapur (V), Ghatkesar (M), Medchal - Malkajgiri (D) - 501 301 TS INDIA

Phone: +08415 200006/07/08

Email: info.vmtw.in

## DEPARTMENT OF ELECTRONICS AND COMMUNICATION ENGINEERING

ADD ON COURSE NAME: Design and FPGA Implementation of DSP Processor using Verilog

Academic Year: 2018-19

Date: 24-10-2018

B.Tech IV-I SEM

DAY WISE ATTENDANCE SHEET

SECTION: ECE-B

S.No	Roll number	24-10-18	25-10-18	26-10-18	27-10-18	29-10-18
1.	15UPIA0441	Swetha	Swetha	Swetha	Swetha	Swetha
2.	15UPIA0442	Archana	Archana	Archana	Archana	Archana
3.	15UPIA0443	Manan	Manan	Manan	Manan	Manan
4.	15UPIA0444	Keerthi	Keerthi	Keerthi	Keerthi	Keerthi
5.	15UPIA0445	Priyanka	Priyanka	Priyanka	Priyanka	Priyanka
6.	15UPIA0446	Mamatha	Mamatha	Mamatha	Mamatha	Mamatha
7.	15UPIA0447	Bhargavi	Bhargavi	Bhargavi	Bhargavi	Bhargavi
8.	15UPIA0448	Ravali	Ravali	Ravali	Ravali	Ravali
9.	15UPIA0449	Su	Su	Su	Su	Su
10.	15UPIA0450	Joshna	Joshna	Joshna	Joshna	Joshna
11.	15UPIA0451	Sanikitha	Sanikitha	Sanikitha	Sanikitha	Sanikitha
12.	15UPIA0452	Srishta	Srishta	Srishta	Srishta	Srishta
13.	15UPIA0453	Ad	Ad	Ad	Ad	Ad
14.	15UPIA0454	K. Puj	K. Puj	K. Puj	K. Puj	K. Puj
15.	15UPIA0455	Kavya	Kavya	Kavya	Kavya	Kavya
16.	15UPIA0456	Savya	Savya	Savya	Savya	Savya
17.	15UPIA0457	Harsha	Harsha	Harsha	Harsha	Harsha
18.	15UPIA0458	Navya	Navya	Navya	Navya	Navya
19.	15UPIA0459	Pooj	Pooj	Pooj	Pooj	Pooj
20.	15UPIA0460	Srija	Srija	Srija	Srija	Srija
21.	15UPIA0461	Laxya	Laxya	Laxya	Laxya	Laxya
22.	15UPIA0462	Chandana	Chandana	Chandana	Chandana	Chandana
23.	15UPIA0463	Sh	Sh	Sh	Sh	Sh
24.	15UPIA0464	ShivaPriya	ShivaPriya	ShivaPriya	ShivaPriya	ShivaPriya
25.	15UPIA0465	Pravalika	Pravalika	Pravalika	Pravalika	Pravalika
26.	15UPIA0466	Sravanthi	Sravanthi	Sravanthi	Sravanthi	Sravanthi
27.	15UPIA0467	M. Yas	M. Yas	M. Yas	M. Yas	M. Yas
28.	15UPIA0468	Shrutha	Shrutha	Shrutha	Shrutha	Shrutha
29.	15UPIA0469	Veda	Veda	Veda	Veda	Veda
30.	15UPIA0470	Yash	Yash	Yash	Yash	Yash
31.	15UPIA0472	Pritya	Pritya	Pritya	Pritya	Pritya
32.	15UPIA0473	Manasa	Manasa	Manasa	Manasa	Manasa



*ASH*  
PRINCIPAL

Vignans Institute of Management & Technology For Women  
Kondapur (V), Ghatkesar (M), Medchal - Malkajgiri (D) - 501  
Telangana State

33.	1SUP1A0474	Nirisha	Nirisha	Nirisha	Nirisha	Nirisha.
34.	1SUP1A0475	J.priyanka	J.priyanka	J.priyanka	J.priyanka	J.priyanka
35.	1SUP1A0476	Nikhil	Nikhil	Nikhil	Nikhil	Nikhil.
36.	1SUP1A0477	kalyani	kalyani	Kalyani	Kalyani	kalyani
37.	1SUP1A0478	Mahesh	Mahesh	Mahesh	Mahesh	Mahesh.
38.	1SUP1A0479	Nirisha	Nirisha	Nirisha	Nirisha	Nirisha
39.	1SUP1A0480	Y.P.f	Y.P.f	Y.P.f	Y.P.f	Y.P.f

  
COORDINATOR

  
ECE,HOD

Head of the Department  
Electronics and Communication Engineering  
Srijan's Institute of Management and Technology For Women  
Kondapur (V), Ghatkesar (M), Medchal-Malkajgiri (Dt), TS  
Pin-501130



  
PRINCIPAL  
Srijan's Institute of Management & Technology For Women  
Kondapur(V), Ghatkesar(M), Medchal-Malkajgiri(Dt), TS-501130  
Telangana State



# VIGNAN'S INSTITUTE OF MANAGEMENT AND TECHNOLOGY FOR WOMEN

Sponsored by Lavu Educational Society, Approved by AICTE, New Delhi & Affiliated to JNTU, Hyderabad.  
Kondapur (V), Ghalkesar (M), Medchal - Malkajgiri (Dt) - 501 301 TS INDIA  
Phone: +0815 200006/07/08 Email: info@vmtw.in

## DEPARTMENT OF ELECTRONICS AND COMMUNICATION ENGINEERING

Date: 31-10-2018.

### PROGRAM REPORT

**Name of the Add on Course:** Design and FPGA Implementation of DSP Processor using Verilog

**Day/Duration:** 35 HOURS

**Time:** 4:00PM TO 5:00PM

**Resource Person:** Mr. ArjunModi, Sr.Engineer, Amtronics PVT, LTD, Hyderabad.

**Name of the Coordinator:** Mr. J. Sunil Kumar, Assistant Professor, VMTW

**Number of the Participants:** 79

**Topics covered:** The following topics covered in this program

**Course Outcomes:** Work with real time projects using Architectural transformation techniques

COs	At the end of the course, students will have the ability to:	POs Mapped	Strength of mapping
CO1	Understand the LTI system characteristics and Multi-rate signal processing.	PO1,PO3	3
CO2	Understand the significance of various filter structures and effects of round off errors	PO1,PO3	2
CO3	Understand the inter-relationship between DFT and various transforms	PO1,PO2	2
CO4	Understand different types of faults that can occur in a system and learn the concept of testing and adding extra hardware to improve testability of system	PO1,PO2	3
CO5	Design building blocks of data path systems, memories and simple logic circuits using PLA, PAL, FPGA and CPLD	PO1,PO2	2

**Assessment Procedure:** The assessment of the Add on course is conducted in Multiple Choice Questions through offline Mode.

Coordinator

PRINCIPAL

Vignan's Institute of Management & Technology For Women  
Kondapur(V), Ghalkesar(M), Medchal-Malkajgiri(Dt)-501301  
Telangana State

ECE, HOD

Head of the Department  
Electronics and Communication Engineering  
Vignan's Institute of Management & Technology For Women  
Kondapur (V), Ghalkesar (M), Medchal-Malkajgiri (Dt)-501301



# VIGNAN'S INSTITUTE OF MANAGEMENT AND TECHNOLOGY FOR WOMEN

(Sponsored by Lavu Educational Society)

Approved by AICTE, New Delhi & Affiliated to JNTUH, Hyderabad.

Kondapur Village, Ghatkesar Mandal, Medchal - Malkajgiri Dist - 501 301 TS, INDIA

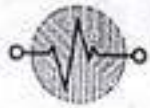

**Amtronics**  
Dedicated to Electronics

## Certificate of Course Completion

*This is to certify that*

**DHODLA ALEKHYA**

*has successfully completed the Add-on course on "DESIGN & FPGA IMPLEMENTATION OF DSP PROCESSOR USING VERILOG" held from 11<sup>TH</sup> SEP to 29<sup>TH</sup> OCT, 2018, Organized by the Department of Electronics and Communication Engineering.*

*In association with Amtronics, Hyderabad.*



*[Signature]*  
Co-ordinator

*[Signature]*  
HoD, ECE

Head of the Department  
Electronics and Communication Engineering  
Vignans Institute of Management and Technology for Women  
Kondapur (V), Ghatkesar (M), R.R. Dist-501 301

**PRINCIPAL**  
Vignans Institute of Management & Technology For Women  
Kondapur(V), Ghatkesar(M), Medchal-Malkajgiri(DT)-501 301  
Telangana State

*[Signature]*  
Principal





# VIGNAN'S INSTITUTE OF MANAGEMENT AND TECHNOLOGY FOR WOMEN

Sponsored by Lavu Educational Society, Approved by AICTE, New Delhi & Affiliated to JNTUH, Hyderabad.

Kondapur (V), Ghatkesar (M), Medchal - Malkajgiri (D) - 501 301 TS INDIA

Phone: +08815 200008/07/08

Email: info@vmbw.in

## DEPARTMENT OF ELECTRONICS AND COMMUNICATION ENGINEERING

VMTW/ECE/AOC/2017-18/1/02

Date:15-08-2017

### CIRCULAR

This is to inform all the III B. Tech ECE students that there will be an Add on course on "Latest trends in chip design for Area and Power Optimization "in association with AMTRONICS PVT LTD. Hyderabad, from 18-08-2017 to 27-09-2017.All students are invited to take part in this course. The participating students will be honored with certificates of participation. During the course you will be encouraged to interact with the speaker and the other participants through the case study discussions.

HOD

Head of the Department  
Electronics and Communication Engineering  
Vignan's Institute of Management and Technology for Women  
Kondapur (V), Ghatkesar (M), R.R. Dist-501 301

Copy to

The Principal, for kind information

IQAC

Notice board

III.B.Tech students

Dept. file



PRINCIPAL

Vignan's Institute of Management & Technology For Women  
Kondapur(V),Ghatkesar(M),Medchal-Malkajgiri(D)-501301  
Telangana State

### About the Department:

Department of Electronics and Communication Engineering was started since the inception of Vignan's Institute of Management and Technology for Women during 2008 with an initial intake of 90. The strength was enhanced to 120 during 2010. The Department had added Post graduate programme in VLSI during the year 2011 and Embedded Systems during 2014 with an intake of 18 each.

The Department has state-of-art laboratories equipped with advanced and well maintained equipment, continuously updated application software packages, more than adequate computing systems with 24x7, 30 MBPS internet facility.

### About the Course:

VLSI Stands for Very-large-scale integration (VLSI), which creates an integrated circuit (IC) by combining millions of MOS (Metal Oxide Silicon transistor) transistors over a single chip. The microprocessor and memory chips are VLSI (Very-large-scale integration) devices. Before the intro of VLSI technology, most ICs had a limited set of roles they could perform. IC (Integrated Circuits) are used in various types of electronic devices. Our mobile phone consists of IC. IC is a circuit where all or some of the circuit elements are inseparably linked and electrically interconnected, so it's considered indivisible for construction and commerce. Before VLSI, IC size used to be much larger than it is now. Because of VLSI, designers can now add millions of transistors and other components on a tiny chip.

### Course Objectives:

- Overview of IC Design
- Aspects of IC Design
- Introduction and Device Characteristics
- Analog IC Design
- Digital IC Design
- Semicustom IC Design/PLD
- Introduction to cadence EDA
- Op Amp Design and Compensation
- VLSI Signal Processing
- VLSI Communication System Design

- Mixed Signal Design /RF IC Design
- FDGA/VHDL

### Expected Outcomes:

At the end of Workshop, participants will be able to

- Model digital systems in VHDL and SystemC at different levels of abstraction.
- Partition a digital system into different subsystems.
- Simulate and verify a design.
- Transfer a design from a version possible to simulate to a version possible to synthesize.
- Use computer-aided design tools to synthesize, map, place, routing, and download the digital designs on the FPGAboard.
- Apply knowledge of mathematics, science, and engineering to design and analysis of analog integrated circuits.
- Identify, formulates, and solves engineering problems in the area of analog integrated circuits.
- Use the techniques, skills, and modern programming tools such as Mentor Graphics, necessary for engineering practice.



Resource Person:  
**Mr. Arjun Modi,**  
Technical Manager,  
Amtronics, Hyderabad.

Co-ordinator:  
**Mr. G. Narendra,**  
Assistant Professor, Dept. of ECE,  
Contact No: +91 94926 39647

**Last Date For Registration: 13<sup>th</sup> Aug, 2017**

# VIGNAN'S INSTITUTE OF MANAGEMENT AND TECHNOLOGY FOR WOMEN

(Sponsored by Livu Educational Society)

Approved by AICTE, New Delhi & Affiliated to JNTUH, Hyderabad.

Kondapur (V), Ghatkesar (M), Medchal - Malkajgiri (D) - 501 301



## ADD-ON COURSE ON "LATEST TRENDS IN CHIP DESIGN FOR AREA & POWER OPTIMIZATION"

**18<sup>TH</sup> AUG TO 27<sup>TH</sup> SEP, 2017**

PRINCIPAL

Vignan's Institute of Management & Technology For Women  
Kondapur(V), Ghatkesar(M), Medchal-Malkajgiri(D) - 501301  
Telangana State

Duration of the Course: **35 Hrs**

Venue:  
**'B'-Block Seminar Hall, VMTW.**

Organized By:  
**DEPARTMENT OF ELECTRONICS AND  
COMMUNICATION ENGINEERING**



# VIGNAN'S INSTITUTE OF MANAGEMENT AND TECHNOLOGY FOR WOMEN

Sponsored by Lavu Educational Society, Approved by AICTE, New Delhi & Affiliated to INTUH, Hyderabad.  
Kondapur (V), Ghatkesar (M), Medchal - Malkajgiri (D) - 501 301 TS INDIA  
Phone: +09815 20006/07/08 Email: info@vmtw.in

## DEPARTMENT OF ELECTRONICS AND COMMUNICATION ENGINEERING

ADD ON COURSE NAME: Latest trends in chip design for Area and Power Optimization

Academic Year: 2017-18

Date: 15-08-2017

B.Tech III-I SEM

DAY WISE SCHEDULE SHEET

SECTION: ECE-A&B

Room number: B-BLOCK SEMINAR HALL.

S.NO	DAY	TOPIC	TIMINGS	DURATION
1.	18-Aug-17	Introduction	04:00pm to 05:00pm	1 hour
2.	19-Aug-17	Full-Voltage Scaling, Constant-	04:00pm to 05:00pm	1 hour
3.	21-Aug-17	MOSFET Capacitances,	04:00pm to 05:00pm	1 hour
4.	22-Aug-17	Properties of MOSFETs	04:00pm to 05:00pm	1 hour
5.	23-Aug-17	Challenges of MOSFET Scaling	04:00pm to 05:00pm	1 hour
6.	24-Aug-17	Layout of CMOS Logic	04:00pm to 05:00pm	1 hour
7.	25-Aug-17	Design Rules, Stick	04:00pm to 05:00pm	1 hour
8.	26-Aug-17	Switching Properties of	04:00pm to 05:00pm	1 hour
9.	28-Aug-17	Static and dynamic	04:00pm to 05:00pm	1 hour
10.	29-Aug-17	CMOS Inverter: Basic Circuit	04:00pm to 05:00pm	1 hour
11.	30-Aug-17	CMOS Inverter: Basic Circuit	04:00pm to 05:00pm	1 hour
12.	31-Aug-17	DC Characteristics, Noise	04:00pm to 05:00pm	1 hour
13.	1-Sep-17	considerations,	04:00pm to 05:00pm	1 hour
14.	2-Sep-17	Inverter Switching	04:00pm to 05:00pm	1 hour
15.	4-Sep-17	Static CMOS Logic Elements:	04:00pm to 05:00pm	1 hour
16.	5-Sep-17	EDA tools, architecture design	04:00pm to 05:00pm	1 hour
17.	6-Sep-17	Overview of SOC Design	04:00pm to 05:00pm	1 hour
18.	7-Sep-17	Techniques to improve a specific	04:00pm to 05:00pm	1 hour
19.	8-Sep-17	CMOS Inverter: Basic Circuit	04:00pm to 05:00pm	1 hour
20.	9-Sep-17	DC Characteristics, Noise	04:00pm to 05:00pm	1 hour
21.	11-Sep-17	Platforms and SoC Design,	04:00pm to 05:00pm	1 hour
22.	12-Sep-17	, Designing Communication	04:00pm to 05:00pm	1 hour
23.	13-Sep-17	CMOS Inverter: Basic Circuit	04:00pm to 05:00pm	1 hour
24.	14-Sep-17	DC Characteristics, Noise	04:00pm to 05:00pm	1 hour
25.	15-Sep-17	SOC Design and Test	04:00pm to 05:00pm	1 hour
26.	16-Sep-17	Design methodologies for SoC	04:00pm to 05:00pm	1 hour
27.	18-Sep-17	Noise and signal integrity	04:00pm to 05:00pm	1 hour
28.	19-Sep-17	System Integration issues for	04:00pm to 05:00pm	1 hour
29.	20-Sep-17	SoC Test Scheduling and Test	04:00pm to 05:00pm	1 hour
30.	21-Sep-17	System Level Power Estimation	04:00pm to 05:00pm	1 hour



*[Signature]*  
PRINCIPAL  
Vignans Institute of Management & Technology for Women  
Kondapur (V), Ghatkesar (M), Medchal - Malkajgiri (D) - 501 301  
T.S.

31.	22-Sep-17	Transaction Level Modeling	04:00pm to 05:00pm	1 hour
32.	23-Sep-17	Design Space, Exploration,	04:00pm to 05:00pm	1 hour
33.	25-Sep-17	SoC Test Scheduling and Test	04:00pm to 05:00pm	1 hour
34.	26-Sep-17	SoC Test Resource partition	04:00pm to 05:00pm	1 hour
35.	27-Sep-17	Test conducted & Feedback	04:00pm to 05:00pm	1 hour
Total 35 hours				

*Nagesh Kumar*  
COORDINATOR



*[Signature]*

HOD

Head of the Department  
Electronics and Communication Engineering  
Vignans Institute of Management and Technology for Women  
Kondapur (V), Ghatkesar (M), R.R. Dist-501301

*[Signature]*  
PRINCIPAL

Vignans Institute of Management & Technology For Women  
Kondapur(V), Ghatkesar(M), Medchal-Malkajgiri(DK)-501301  
Telangana State



# VIGNAN'S INSTITUTE OF MANAGEMENT AND TECHNOLOGY FOR WOMEN

Sponsored by Lava Educational Society, Approved by AICTE, New Delhi & Affiliated to JNTU, Hyderabad.  
Kondapur (V), Ghatkesar (M), Medchal - Malkajgiri (D) - 501 301 TS INDIA  
Phone: +08015 200006/07/08 Email: info@vimbw.in

## DEPARTMENT OF ELECTRONICS AND COMMUNICATION ENGINEERING

Academic Year: 2017-18

Date: 11-08-2017

ADD ON COURSE NAME: Latest trends in chip design for Area and Power Optimization

B.Tech III-I SEM STUDENT REGISTRATION FORM SECTION: ECE-A

S.NO	ROLL NUMBER	NAME OF THE STUDENT	SIGNATURE
1	15UP1A0401	BEDUDHURI MEGHANA	Meghana
2	15UP1A0402	C VARSHA REDDY	Varsha
3	15UP1A0403	CHENNU LAXMI PRASANNA	Laxmi
4	15UP1A0405	CHILUMULA RACHANA	Rachana
5	15UP1A0406	CHUNCHU RAMYA SRI	Ramyasri
6	15UP1A0407	DADI SHIVANJALI	Anjali
7	15UP1A0408	DEVARAKONDA KEERTHI	Keerthi
8	15UP1A0409	DEVARAKONDA PREETHI	Preethi
9	15UP1A0410	DHODLA ALEKHYA	Alekhyasri
10	15UP1A0411	DUMALA PRIYANKA	Priyanka
11	15UP1A0412	G VYSHNAVI	Vyshnavi
12	15UP1A0413	GADDAMEEDI ANUSHA	Anusha
13	15UP1A0414	GANGAPURAM HIMAJA	Himaja
14	15UP1A0415	GOPALADAS MOUNIKA	Manika
15	15UP1A0416	GUNDA DEVIKA	Devika
16	15UP1A0417	GUNTI SRAVANI	Sravani
17	15UP1A0418	HARIVENKATANAGA HARIPRIYA	Haripriya
18	15UP1A0419	JAKKIDI PRANAYA	Pranaya
19	15UP1A0420	KAKANI TEJA SRI	Tejasri
20	15UP1A0421	KANDADI NIKHITHA	Nikhitha
21	15UP1A0422	KANDHATI UMA	Uma
22	15UP1A0423	KETHIREDDY PRATHYUSHA	Prathyusha
23	15UP1A0424	KODEMALA SAIKRUPA	Saikrupa
24	15UP1A0425	KOLA SONIA	Sonia
25	15UP1A0426	L VIJITHA	Vijitha
26	15UP1A0427	MAINELLY NIKHITHA	Nikhitha
27	15UP1A0428	MALLELA MAMATHA	Mamatha
28	15UP1A0429	MATTI PALLAVI	Pallavi
29	15UP1A0430	MOJJA KAVERI	Kaveri
30	15UP1A0431	MULLAPUDI VENKATA LIKHITA	Likhita
31	15UP1A0432	PABBA VIKASINI	Vikasini
32	15UP1A0434	PALADUGULA SRIKAVYA	Kavya
33	15UP1A0435	PAPINENI BHAVANA	Bhavana
34	15UP1A0436	PERUGUPALLI VIDYULLEKHA	Vidhyullekha



  
PRINCIPAL

Vignans Institute of Management & Technology for Women  
Kondapur (V), Ghatkesar (M), Medchal-Malkajgiri (D) - 501301  
Telangana State

35	15UPIA0437	PINNAPU REDDY RAMYA	Ramya
36	15UPIA0438	S AMRUTHA VARSHINI	Varshini
37	15UPIA0439	SALLA VARSHINI	Varshini
38	15UPIA0440	SAMUDRALA NANDINI	
39	15UPIA0441	SUDAGANI SWETHA	Swetha
40	15UPIA0442	VONTARI ARCHANA	Archana

*Asimiro*  
COORDINATOR

*W*  
HOD

Head of the Department  
Department of Management & Technology For Women  
Vignani Institute of Management & Technology For Women  
Kondapur (V), Dist:Guntur (N), Medchal (D)  
Pin-501301  
Telangana State



*ASH*

PRINCIPAL

Vignani's Institute of Management & Technology For Women  
Kondapur(V), Dist:Guntur(N), Medchal-Medchal(D)-501301  
Telangana State



# VIGNAN'S INSTITUTE OF MANAGEMENT AND TECHNOLOGY FOR WOMEN

Sponsored by Laxmi Educational Society, Approved by AICTE, New Delhi & Affiliated to JNTUH, Hyderabad.  
Kondapur (V), Ghatkesar (M), Medchal - Malkajgiri (D) - 501 301 TS INDIA.  
Phone: +08615 20006/07/08 Email: info@vmtw.in

## DEPARTMENT OF ELECTRONICS AND COMMUNICATION ENGINEERING

Academic Year: 2017-18

Date: 17-08-2017

ADD ON COURSE NAME: Latest trends in chip design for Area and Power Optimization

B.Tech III-I SEM STUDENT REGISTERED LIST SECTION: ECE-A

S.NO	ROLL NUMBER	NAME OF THE STUDENT
1	15UP1A0401	BEDUDHURI MEGHANA
2	15UP1A0402	C VARSHA REDDY
3	15UP1A0403	CHENNU LAXMI PRASANNA
4	15UP1A0405	CHILUMULA RACHANA
5	15UP1A0406	CHUNCHU RAMYA SRI
6	15UP1A0407	DADI SHIVANJALI
7	15UP1A0408	DEVARAKONDA KEERTHI
8	15UP1A0409	DEVARAKONDA PREETHI
9	15UP1A0410	DHODLA ALEKHYA
10	15UP1A0412	G VYSHNAVI
11	15UP1A0414	GANGAPURAM HIMAJA
12	15UP1A0415	GOPALADAS MOUNIKA
13	15UP1A0416	GUNDA DEVIKA
14	15UP1A0417	GUNTI SRAVANI
15	15UP1A0418	HARIVENKATANAGA HARIPRIYA
16	15UP1A0419	JAKKIDI PRANAYA
17	15UP1A0420	KAKANI TEJA SRI
18	15UP1A0421	KANDADI NIKHITHA
19	15UP1A0422	KANDHATI UMA
20	15UP1A0423	KETHIREDDY PRATHYUSHA
21	15UP1A0424	KODEMALA SAIKRUPA
22	15UP1A0425	KOLA SONIA
23	15UP1A0426	L VJITHA
24	15UP1A0427	MAINELLY NIKHITHA
25	15UP1A0429	MATTI PALLAVI
26	15UP1A0430	MOJJA KAVERI
27	15UP1A0431	MULLAPUDI VENKATA LIKHITA
28	15UP1A0432	PABBA VIKASINI
29	15UP1A0434	PALADUGULA SRIKAVYA
30	15UP1A0435	PAPINENI BHAVANA
31	15UP1A0436	PERUGUPALLI VIDYULLEKHA
32	15UP1A0437	PINNAPU REDDY RAMYA
33	15UP1A0438	S AMRUTHA VARSHINI
34	15UP1A0439	SALLA VARSHINI
35	15UP1A0441	SUDAGANI SWETHA
36	15UP1A0442	VONTARI ARCHANA

*Vanasha*  
COORDINATOR

*[Signature]*  
HOD



*[Signature]*  
PRINCIPAL

Vignans Institute of Management & Technology For Women  
Kondapur (V), Ghatkesar (M), Medchal-Malkajgiri (D)-501301  
Telangana State

Head of the Department  
Electronics and Communication Engineering  
Vignans Institute of Management & Technology For Women  
Kondapur (V), Ghatkesar (M), Medchal-Malkajgiri (D)-501301



# VIGNAN'S INSTITUTE OF MANAGEMENT AND TECHNOLOGY FOR WOMEN

Sponsored by Law Educational Society, Approved by AICTE, New Delhi & Affiliated to JNTUH, Hyderabad.  
Kondapur (V), Ghatkesar (M), Medchal - Malkajgiri (D) - 501 301 TS (INDIA)  
Phone: +08615 20006/07/08 Email: info@vignans.in

## DEPARTMENT OF ELECTRONICS AND COMMUNICATION ENGINEERING

Academic Year: 2017-18

Date: 11-08-2017

ADD ON COURSE NAME: Latest trends in chip design for Area and Power Optimization

B.Tech III-I SEM

STUDENT REGISTRATION FORM SECTION: ECE-B

S.NO	ROLL NUMBER	NAME OF THE STUDENT	SIGNATURE
1	15UP1A0443	A MANASA REDDY BODELA	Manasa
2	15UP1A0444	BALA THARUNA KEERTHI	Bala
3	15UP1A0445	BANALA PRIYANKA	Banala
4	15UP1A0446	BANGARAM MAMATHA	Bangaram
5	15UP1A0447	BASIREDDY BHARATHI REDDY	Bharathi
6	15UP1A0448	BILLAKANTI RAVALI	Ravali
7	15UP1A0449	DEEKONDA SUGANDHA	Sugandha
8	15UP1A0450	GADDAM JOSHNA	Joshna
9	15UP1A0451	GOGINENI NIKITHA	Nikitha
10	15UP1A0452	GUNDAGANI NAGASHIRISHA	Nagashirisha
11	15UP1A0453	JALA MOUNIKA	Mounika
12	15UP1A0454	K RAMYA REDDY	Ramyas
13	15UP1A0455	KANALA KAVYA REDDY	Kavya
14	15UP1A0456	KANDUKURI SRAVYA	Sravya
15	15UP1A0457	KARNATI SRIHARSHA	Sriharsha
16	15UP1A0458	KASULA NAVYA SRI	Navya
17	15UP1A0459	KETHIREDDY RAMYA	Ramyas
18	15UP1A0460	KOMATIREDDY SIRIJA	Sirija
19	15UP1A0461	LAVANYA SEELAM	Seelam
20	15UP1A0462	M HARICHANDANA	Harichandana
21	15UP1A0463	MAHAJAN SRADHA	Sradha
22	15UP1A0464	MANCHALA SHIVAPRIYA	Shivapriya
23	15UP1A0465	MANTIPALLY PRAVALIKA	Pravalika
24	15UP1A0466	METTU SRAVANTHI	Sravanthi
25	15UP1A0467	MUNAGALA YASHASWINI	Yashaswini
26	15UP1A0468	NAGANOLLU ANUSHA REDDY	Anusha
27	15UP1A0469	PACHA VEDASRI	Vedasri
28	15UP1A0470	VENKATA YASHASWINI	Yashaswini
29	15UP1A0471	PERAMALLA KAVYA	Kavya
30	15UP1A0472	POCHAMPALLY PRIYANKA	Priyanka
31	15UP1A0473	POTHEPAKA MANASA	Manasa
32	15UP1A0474	SHEELA NIKITHA	Nikitha
33	15UP1A0475	SHERIKAR PRIYANKA	Priyanka
34	15UP1A0476	SHIVA NIKHITHA	Nikhitha



PRINCIPAL

Vignans Institute of Management & Technology for Women  
Kondapur(V), Ghatkesar(M), Medchal-Malkajgiri(D)-501301  
Telangana State



35	15UP1A0477	SUNKI KALYANI	<i>da</i>
36	15UP1A0478	VEMURI MAHATHI	<i>Mahathi</i>
37	15UP1A0479	YASA MINISHA REDDY	<i>—</i>
38	15UP1A0480	YERUVA SAGAR BALA DIVYA	<i>Y. Divya</i>
39	16UP5A0401	K.DIVYA	<i>Divya</i>
40	15C31A0432	GADILA PRASANNA LAXMI	<i>A</i>

*A. Anandra*  
COORDINATOR

*st*  
HOD  
Electronics and Communication Engineering  
Vignans Institute of Management & Technology For Women  
Kondapur (V), Ghateboor (M), Modchal-Malkajgiri (D)-501301, T.S.



*ASH*  
PRINCIPAL  
Vignans Institute of Management & Technology For Women  
Kondapur(V), Ghateboor(M), Modchal-Malkajgiri(D)-501301,  
Telangana State



# VIGNAN'S INSTITUTE OF MANAGEMENT AND TECHNOLOGY FOR WOMEN

Sponsored by Lavu Educational Society, Approved by AICTE, New Delhi & Affiliated to JNTUH, Hyderabad.  
Kondapur (V), Ghatkesar (M), Medchal - Malkajgiri (D) - 501 301 TS INDIA  
Phone: +08815 200008/07/06 Email: info@vimbw.in

## DEPARTMENT OF ELECTRONICS AND COMMUNICATION ENGINEERING

Academic Year: 2017-18

Date: 17-08-2017

ADD ON COURSE NAME: Latest trends in chip design for Area and Power Optimization

B.Tech III-I SEM

STUDENT REGISTERED LIST

SECTION: ECE-B

S.NO	ROLL NUMBER	NAME OF THE STUDENT
1	15UP1A0443	A MANASA REDDY BODELA
2	15UP1A0444	BALA THARUNA KEERTHI
3	15UP1A0445	BANALA PRIYANKA
4	15UP1A0447	BASIREDDY BHARATHI REDDY
5	15UP1A0448	BILLAKANTI RAVALI
6	15UP1A0449	DEEKONDA SUGANDHA
7	15UP1A0450	GADDAM JOSHNA
8	15UP1A0451	GOGINENI NIKITHA
9	15UP1A0452	GUNDAGANI NAGASHIRISHA
10	15UP1A0453	JALA MOUNIKA
11	15UP1A0454	K RAMYA REDDY
12	15UP1A0455	KANALA KAVYA REDDY
13	15UP1A0456	KANDUKURI SRAVYA
14	15UP1A0457	KARNATI SRIHARSHA
15	15UP1A0459	KETHIREDDY RAMYA
16	15UP1A0460	KOMATIREDDY SIRIJA
17	15UP1A0461	LAVANYA SEELAM
18	15UP1A0462	M HARICHANDANA
19	15UP1A0463	MAHAJAN SRADHA
20	15UP1A0464	MANCHALA SHIVAPRIYA
21	15UP1A0465	MANTIPALLY PRAVALIKA
22	15UP1A0466	METTU SRAVANTHI
23	15UP1A0467	MUNAGALA YASHASWINI
24	15UP1A0468	NAGANOLLU ANUSHA REDDY
25	15UP1A0471	PERAMALLA KAVYA
26	15UP1A0472	POCHAMPALLY PRIYANKA
27	15UP1A0473	POTHEPAKA MANASA
28	15UP1A0474	SHEELA NIKITHA
29	15UP1A0475	SHERIKAR PRIYANKA
30	15UP1A0476	SHIVA NIKHITHA
31	15UP1A0477	SUNKI KALYANI
32	15UP1A0478	VEMURI MAHATHI
33	15UP1A0480	YERUVA SAGAR BALA DIVYA
34	16UP5A0401	K.DIVYA
35	15C31A0432	GADILA PRASANNA LAXMI

*A. Abinda*  
COORDINATOR

*kb*  
HOD



*Vignans*  
PRINCIPAL  
Vignans Institute of Management & Technology for Women  
Kondapur(V), Ghatkesar(M), Medchal-Malkajgiri(D)-501301  
Telangana State



# VIGNAN'S INSTITUTE OF MANAGEMENT AND TECHNOLOGY FOR WOMEN

Sponsored by Laxmi Educational Society, Approved by AICTE, New Delhi & Affiliated to JNTU, Hyderabad.  
Kondapur (V), Ghatkesar (M), Medchal - Malkajgiri (D) - 501 301 TS INDIA  
Phone: +08615 20006/07/08 Email: info@vignans.in

## DEPARTMENT OF ELECTRONICS AND COMMUNICATION ENGINEERING

ADD ON COURSE NAME: Latest trends in chip design for Area and Power Optimization

Academic Year: 2017-18

Date: 18-08-2017

B.Tech III-I SEM

DAY WISE ATTENDANCE SHEET

SECTION: ECE-A

S.No	Roll Number	18-Aug-17	19-Aug-17	21-Aug-17	22-Aug-17	23-Aug-17
1	15UPIA0401	Mouni	Mouni	Mouni	Mouni	Mouni
2	15UPIA0402	Varsha	Varsha	Varsha	Varsha	Varsha
3	15UPIA0403	Laxmi	Laxmi	Laxmi	Laxmi	Laxmi
4	15UPIA0405	Rubana	Rubana	Rubana	Rubana	Rubana
5	15UPIA0406	Priyanka	Priyanka	Priyanka	Priyanka	Priyanka
6	15UPIA0407	Anjali	Anjali	Anjali	Anjali	Anjali
7	15UPIA0408	Rt	Rt	Rt	Rt	Rt
8	15UPIA0409	Poothi	Poothi	Poothi	Poothi	Poothi
9	15UPIA0410	Alekhyas	Alekhyas	Alekhyas	Alekhyas	Alekhyas
10	15UPIA0412	Vyshaavi	Vyshaavi	Vyshaavi	Vyshaavi	Vyshaavi
11	15UPIA0414	Himaja	Himaja	Himaja	Himaja	Himaja
12	15UPIA0415	Manika	Manika	Manika	Manika	Manika
13	15UPIA0416	Devika	Devika	Devika	Devika	Devika
14	15UPIA0417	Shravan	Shravan	Shravan	Shravan	Shravan
15	15UPIA0418	Haripriya	Haripriya	Haripriya	Haripriya	Haripriya
16	15UPIA0419	Pranaya	Pranaya	Pranaya	Pranaya	Pranaya
17	15UPIA0420	Tajaji	Tajaji	Tajaji	Tajaji	Tajaji
18	15UPIA0421	Nikhitha	Nikhitha	Nikhitha	Nikhitha	Nikhitha
19	15UPIA0422	Ilma	Ilma	Ilma	Ilma	Ilma
20	15UPIA0423	Pooj	Pooj	Pooj	Pooj	Pooj
21	15UPIA0424	Sai Krupa	Sai Krupa	Sai Krupa	Sai Krupa	Sai Krupa
22	15UPIA0425	K.Sonia	K.Sonia	K.Sonia	K.Sonia	K.Sonia
23	15UPIA0426	Vijetha	Vijetha	Vijetha	Vijetha	Vijetha
24	15UPIA0427	Nikhitha	Nikhitha	Nikhitha	Nikhitha	Nikhitha
25	15UPIA0429	Pallavi	Pallavi	Pallavi	Pallavi	Pallavi
26	15UPIA0430	Kavari	Kavari	Kavari	Kavari	Kavari
27	15UPIA0431	Likithi	Likithi	Likithi	Likithi	Likithi
28	15UPIA0432	Vikasini	Vikasini	Vikasini	Vikasini	Vikasini
29	15UPIA0434	Kavya	Kavya	Kavya	Kavya	Kavya
30	15UPIA0435	Bhavana	Bhavana	Bhavana	Bhavana	Bhavana
31	15UPIA0436	Vidya	Vidya	Vidya	Vidya	Vidya
32	15UPIA0437	Ramya	Ramya	Ramya	Ramya	Ramya
33	15UPIA0438	Vaishali	Vaishali	Vaishali	Vaishali	Vaishali
34	15UPIA0439	Vaishini	Vaishini	Vaishini	Vaishini	Vaishini
35	15UPIA0441	Swetha	Swetha	Swetha	Swetha	Swetha
36	15UPIA0442	Archana	Archana	Archana	Archana	Archana

*Narandya*  
COORDINATOR

*HA*  
HOD



*ADU*  
PRINCIPAL

Vignans Institute of Management & Technology  
Kondapur(V), Ghatkesar(M), Medchal-Malkajgiri(D) - 501301  
Telangana State

Head of the Department  
Electronics and Communication Engineering  
Vignans Institute of Management & Technology  
Kondapur(V), Ghatkesar(M), Medchal-Malkajgiri(D) - 501301  
Telangana State



# VIGNAN'S INSTITUTE OF MANAGEMENT AND TECHNOLOGY FOR WOMEN

Sponsored by Laxmi Educational Society, Approved by AICTE, New Delhi & Affiliated to JNTUH, Hyderabad.  
Kondapur (V), Ghatkesar (M), Medchal - Malkajgiri (D) - 501 301 TS INDIA  
Phone: +08615 200006/07/08 Email: info@vmtw.in

## DEPARTMENT OF ELECTRONICS AND COMMUNICATION ENGINEERING

ADD ON COURSE NAME: Latest trends in chip design for Area and Power Optimization

Academic Year: 2017-18

Date: 18-08-2017

B.Tech III-I SEM

DAY WISE ATTENDANCE SHEET

SECTION: ECE-B

S.No	Roll Number	18-Aug-17	19-Aug-17	21-Aug-17	22-Aug-17	23-Aug-17
1	15UP1A0443	Khad	Khad	Khad	Khad	Khad
2	15UP1A0444	Kee	Kee	Kee	Kee	Kee
3	15UP1A0445	Rishi	Rishi	Rishi	Rishi	Rishi
4	15UP1A0447	Bharathi	Bharathi	Bharathi	Bharathi	Bharathi
5	15UP1A0448	Kavali	Kavali	Kavali	Kavali	Kavali
6	15UP1A0449	Sua	Sua	Sua	Sua	Sua
7	15UP1A0450	Jashna	Jashna	Jashna	Jashna	Jashna
8	15UP1A0451	Prinitha	Prinitha	Prinitha	Prinitha	Prinitha
9	15UP1A0452	Ce	Ce	Ce	Ce	Ce
10	15UP1A0453	Mounika	Mounika	Mounika	Mounika	Mounika
11	15UP1A0454	K.P.Raj	K.P.Raj	K.P.Raj	K.P.Raj	K.P.Raj
12	15UP1A0455	Kavya	Kavya	Kavya	Kavya	Kavya
13	15UP1A0456	Sri	Sri	Sri	Sri	Sri
14	15UP1A0457	Sa	Sa	Sa	Sa	Sa
15	15UP1A0459	Ramya	Ramya	Ramya	Ramya	Ramya
16	15UP1A0460	Srija	Srija	Srija	Srija	Srija
17	15UP1A0461	S	S	S	S	S
18	15UP1A0462	Chandana	Chandana	Chandana	Chandana	Chandana
19	15UP1A0463	Saija	Saija	Saija	Saija	Saija
20	15UP1A0464	Shiba	Shiba	Shiba	Shiba	Shiba
21	15UP1A0465	Pravalika	Pravalika	Pravalika	Pravalika	Pravalika
22	15UP1A0466	Sruti	Sruti	Sruti	Sruti	Sruti
23	15UP1A0467	Srija	Srija	Srija	Srija	Srija
24	15UP1A0468	Kavya	Kavya	Kavya	Kavya	Kavya
25	15UP1A0471	Kavya	Kavya	Kavya	Kavya	Kavya
26	15UP1A0472	Priya	Priya	Priya	Priya	Priya
27	15UP1A0473	Mansi	Mansi	Mansi	Mansi	Mansi
28	15UP1A0474	Deep	Deep	Deep	Deep	Deep
29	15UP1A0475	A.priyanka	A.priyanka	A.priyanka	A.priyanka	A.priyanka
30	15UP1A0476	Naf	Naf	Naf	Naf	Naf
31	15UP1A0477	Sa	Sa	Sa	Sa	Sa
32	15UP1A0478	Mahathi	Mahathi	Mahathi	Mahathi	Mahathi
33	15UP1A0480	V.P.Raj	V.P.Raj	V.P.Raj	V.P.Raj	V.P.Raj
34	16UP5A0401	Rupa	Rupa	Rupa	Rupa	Rupa
35	15C31A0432	Pa	Pa	Pa	Pa	Pa

*A. Anandya*  
COORDINATOR

*AB*  
HOD



*ASH*  
PRINCIPAL

Vignani's Institute of Management & Technology For Women  
Kondapur(V), Ghatkesar(M), Medchal-Malkajgiri(DI)-501301  
Telangana State



# VIGNAN'S INSTITUTE OF MANAGEMENT AND TECHNOLOGY FOR WOMEN

Sponsored by Law Educational Society, Approved by AICTE, New Delhi & Affiliated to JNTU, Hyderabad.  
Kondapur (V), Ghatkesar (M), Medchal - Malkajgiri (D) - 501 301 TS INDIA  
Phone: +08015 200006/07/08 Email: info@vmbw.in

## DEPARTMENT OF ELECTRONICS AND COMMUNICATION ENGINEERING

ADD ON COURSE NAME: Latest trends in chip design for Area and Power Optimization

Academic Year: 2017-18

Date: 24-08-2017

B.Tech III-I SEM

DAY WISE ATTENDANCE SHEET

SECTION: ECE-A

No	Roll Number	24-Aug-17	25-Aug-17	26-Aug-17	28-Aug-17	29-Aug-17
1	15UPIA0401	MEEJ	MEEJ	MEEJ	MEEJ	MEEJ
2	15UPIA0402	Vaishya	Vaishya	Vaishya	Vaishya	Vaishya
3	15UPIA0403	Laxmi	Laxmi	Laxmi	Laxmi	Laxmi
4	15UPIA0405	Pachara	Pachara	Pachara	Pachara	Pachara
5	15UPIA0406	Ramya	Ramya	Ramya	Ramya	Ramya
6	15UPIA0407	Arjuni	Arjuni	Arjuni	Arjuni	Arjuni
7	15UPIA0408	Et	Et	Et	Et	Et
8	15UPIA0409	Fazitha	Fazitha	Fazitha	Fazitha	Fazitha
9	15UPIA0410	Alekhyas	Alekhyas	Alekhyas	Alekhyas	Alekhyas
10	15UPIA0412	Vishvika	Vishvika	Vishvika	Vishvika	Vishvika
11	15UPIA0414	Himaja	Himaja	Himaja	Himaja	Himaja
12	15UPIA0415	Moxsika	Moxsika	Moxsika	Moxsika	Moxsika
13	15UPIA0416	Devika	Devika	Devika	Devika	Devika
14	15UPIA0417	Sravani	Sravani	Sravani	Sravani	Sravani
15	15UPIA0418	Hosapriya	Hosapriya	Hosapriya	Hosapriya	Hosapriya
16	15UPIA0419	Pranaya	Pranaya	Pranaya	Pranaya	Pranaya
17	15UPIA0420	Tajaji	Tajaji	Tajaji	Tajaji	Tajaji
18	15UPIA0421	Nikhitha	Nikhitha	Nikhitha	Nikhitha	Nikhitha
19	15UPIA0422	Elana	Elana	Elana	Elana	Elana
20	15UPIA0423	Pooj	Pooj	Pooj	Pooj	Pooj
21	15UPIA0424	Sai Krupa	Sai Krupa	Sai Krupa	Sai Krupa	Sai Krupa
22	15UPIA0425	k.sonia	k.sonia	k.sonia	k.sonia	k.sonia
23	15UPIA0426	Vijetha	Vijetha	Vijetha	Vijetha	Vijetha
24	15UPIA0427	Nikhitha	Nikhitha	Nikhitha	Nikhitha	Nikhitha
25	15UPIA0429	Pallavi	Pallavi	Pallavi	Pallavi	Pallavi
26	15UPIA0430	Taruni	Taruni	Taruni	Taruni	Taruni
27	15UPIA0431	Likhitha	Likhitha	Likhitha	Likhitha	Likhitha
28	15UPIA0432	Vikasini	Vikasini	Vikasini	Vikasini	Vikasini
29	15UPIA0434	Laxya	Laxya	Laxya	Laxya	Laxya
30	15UPIA0435	Bharana	Bharana	Bharana	Bharana	Bharana
31	15UPIA0436	Vidya	Vidya	Vidya	Vidya	Vidya
32	15UPIA0437	Ramya	Ramya	Ramya	Ramya	Ramya
33	15UPIA0438	Vaishya	Vaishya	Vaishya	Vaishya	Vaishya
34	15UPIA0439	Vasithi	Vasithi	Vasithi	Vasithi	Vasithi
35	15UPIA0441	Sreetha	Sreetha	Sreetha	Sreetha	Sreetha
36	15UPIA0442	Archana	Archana	Archana	Archana	Archana



COORDINATOR

PRINCIPAL

HOD

Vignans Institute of Management & Technology For Women  
Kondapur (V), Ghatkesar (M), Medchal - Malkajgiri (D) - 501 301 TS INDIA  
Telangana State



# VIGNAN'S INSTITUTE OF MANAGEMENT AND TECHNOLOGY FOR WOMEN

Sponsored by Vignans Educational Society, Approved by AICTE, New Delhi & Affiliated to JNTU, Hyderabad.  
Kondapur (V), Ghatkesar (M), Medchal - Malkajgiri (D) - 501 301 TS INDIA.  
Phone: +0815 200006/07/08 Email: info@vignans.edu

## DEPARTMENT OF ELECTRONICS AND COMMUNICATION ENGINEERING

ADD ON COURSE NAME: Latest trends in chip design for Area and Power Optimization

Academic Year: 2017-18

Date: 24-08-2017

B.Tech III-I SEM

DAY WISE ATTENDANCE SHEET

SECTION: ECE-B

S.No	Roll Number	24-Aug-17	25-Aug-17	26-Aug-17	28-Aug-17	29-Aug-17
1	15UPIA0443	Mara	Mara	Mara	Mara	Mara
2	15UPIA0444	Kee	Kee	Kee	Kee	Kee
3	15UPIA0445	Pooja	Pooja	Pooja	Pooja	Pooja
4	15UPIA0447	Bharathi	Bharathi	Bharathi	Bharathi	Bharathi
5	15UPIA0448	Ravali	Ravali	Ravali	Ravali	Ravali
6	15UPIA0449	Sua	Sua	Sua	Sua	Sua
7	15UPIA0450	Jashna	Jashna	Jashna	Jashna	Jashna
8	15UPIA0451	Giritha	Giritha	Giritha	Giritha	Giritha
9	15UPIA0452	Lu	Lu	Lu	Lu	Lu
10	15UPIA0453	Mounika	Mounika	Mounika	Mounika	Mounika
11	15UPIA0454	K.Pul	K.Pul	K.Pul	K.Pul	K.Pul
12	15UPIA0455	Kavya	Kavya	Kavya	Kavya	Kavya
13	15UPIA0456	Sravya	Sravya	Sravya	Sravya	Sravya
14	15UPIA0457	Se	Se	Se	Se	Se
15	15UPIA0459	Ramya	Ramya	Ramya	Ramya	Ramya
16	15UPIA0460	Sriya	Sriya	Sriya	Sriya	Sriya
17	15UPIA0461	S	S	S	S	S
18	15UPIA0462	Chandana	Chandana	Chandana	Chandana	Chandana
19	15UPIA0463	Adi	Adi	Adi	Adi	Adi
20	15UPIA0464	Shika	Shika	Shika	Shika	Shika
21	15UPIA0465	Pravalika	Pravalika	Pravalika	Pravalika	Pravalika
22	15UPIA0466	Sravya	Sravya	Sravya	Sravya	Sravya
23	15UPIA0467	AB	AB	AB	AB	AB
24	15UPIA0468	Adi	Adi	Adi	Adi	Adi
25	15UPIA0471	Kavya	Kavya	Kavya	Kavya	Kavya
26	15UPIA0472	Pooja	Pooja	Pooja	Pooja	Pooja
27	15UPIA0473	Mans	Mans	Mans	Mans	Mans
28	15UPIA0474	Deep	Deep	Deep	Deep	Deep
29	15UPIA0475	Prityanka	Prityanka	Prityanka	Prityanka	Prityanka
30	15UPIA0476	Nat	Nat	Nat	Nat	Nat
31	15UPIA0477	Lo	Lo	Lo	Lo	Lo
32	15UPIA0478	Mahathi	Mahathi	Mahathi	Mahathi	Mahathi
33	15UPIA0480	V.Pul	V.Pul	V.Pul	V.Pul	V.Pul
34	16UP5A0401	Diya	Diya	Diya	Diya	Diya
35	15C31A0432	Pa	Pa	Pa	Pa	Pa

*(Signature)*  
COORDINATOR

*(Signature)*  
HOD



*(Signature)*  
PRINCIPAL

Vignans Institute of Management & Technology For Women  
Kondapur(V), Ghatkesar(M), Medchal-Malkajgiri(D) - 501301  
Telangana State

Head of the Department  
Electronics and Communication Engineering  
Vignans Institute of Management & Technology For Women  
Kondapur(V), Ghatkesar(M), Medchal-Malkajgiri(D) - 501301



# VIGNAN'S INSTITUTE OF MANAGEMENT AND TECHNOLOGY FOR WOMEN

Sponsored by Laxu Educational Society, Approved by AICTE, New Delhi & Affiliated to JNTU, Hyderabad  
Kondapur (V), Ghatkesar (M), Medchal - Malkajgiri (D) - 501 301 TS INDIA  
Phone: +98615 200006/07/08 Email: info@vmtw.in

## DEPARTMENT OF ELECTRONICS AND COMMUNICATION ENGINEERING

ADD ON COURSE NAME: Latest trends in chip design for Area and Power Optimization

Academic Year: 2017-18

Date: 30-08-2017

B.Tech III-I SEM

DAY WISE ATTENDANCE SHEET

SECTION: ECE-A

S.No	Roll number	30-Aug-17	31-Aug-17	1-Sep-17	2-Sep-17	4-Sep-17
1	15UPIA0401	Meh	Meh	Meh	Meh	Meh
2	15UPIA0402	Vaishya	Vaishya	Vaishya	Vaishya	Vaishya
3	15UPIA0403	Laxmi	Laxmi	Laxmi	Laxmi	Laxmi
4	15UPIA0405	Rubana	Rubana	Rubana	Rubana	Rubana
5	15UPIA0406	Priya	Priya	Priya	Priya	Priya
6	15UPIA0407	Anjali	Anjali	Anjali	Anjali	Anjali
7	15UPIA0408	R	R	R	R	R
8	15UPIA0409	Poothi	Poothi	Poothi	Poothi	Poothi
9	15UPIA0410	Alekhy	Alekhy	Alekhy	Alekhy	Alekhy
10	15UPIA0412	Vishnu	Vishnu	Vishnu	Vishnu	Vishnu
11	15UPIA0414	Himaja	Himaja	Himaja	Himaja	Himaja
12	15UPIA0415	Manika	Manika	Manika	Manika	Manika
13	15UPIA0416	Devika	Devika	Devika	Devika	Devika
14	15UPIA0417	Sravani	Sravani	Sravani	Sravani	Sravani
15	15UPIA0418	Harpriya	Harpriya	Harpriya	Harpriya	Harpriya
16	15UPIA0419	Pranaya	Pranaya	Pranaya	Pranaya	Pranaya
17	15UPIA0420	Tejas	Tejas	Tejas	Tejas	Tejas
18	15UPIA0421	Nikhitha	Nikhitha	Nikhitha	Nikhitha	Nikhitha
19	15UPIA0422	Alma	Alma	Alma	Alma	Alma
20	15UPIA0423	Pooj	Pooj	Pooj	Pooj	Pooj
21	15UPIA0424	Sai Krupa	Sai Krupa	Sai Krupa	Sai Krupa	Sai Krupa
22	15UPIA0425	K. Sonia	K. Sonia	K. Sonia	K. Sonia	K. Sonia
23	15UPIA0426	Vijetha	Vijetha	Vijetha	Vijetha	Vijetha
24	15UPIA0427	Nikhitha	Nikhitha	Nikhitha	Nikhitha	Nikhitha
25	15UPIA0429	Pallavi	Pallavi	Pallavi	Pallavi	Pallavi
26	15UPIA0430	Kaveri	Kaveri	Kaveri	Kaveri	Kaveri
27	15UPIA0431	Likhitha	Likhitha	Likhitha	Likhitha	Likhitha
28	15UPIA0432	Vikasini	Vikasini	Vikasini	Vikasini	Vikasini
29	15UPIA0434	Kavya	Kavya	Kavya	Kavya	Kavya
30	15UPIA0435	Bhavana	Bhavana	Bhavana	Bhavana	Bhavana
31	15UPIA0436	Vidya	Vidya	Vidya	Vidya	Vidya
32	15UPIA0437	Ranya	Ranya	Ranya	Ranya	Ranya
33	15UPIA0438	Vaishali	Vaishali	Vaishali	Vaishali	Vaishali
34	15UPIA0439	Vaishini	Vaishini	Vaishini	Vaishini	Vaishini
35	15UPIA0441	Sweetha	Sweetha	Sweetha	Sweetha	Sweetha
36	15UPIA0442	Ashara	Ashara	Ashara	Ashara	Ashara



*Ajitha*  
COORDINATOR

*lg*  
HOD

*[Signature]*  
PRINCIPAL

Vignan's Institute of Management & Technology For Women  
Kondapur (V), Ghatkesar (M), Medchal - Malkajgiri (D) - 501 301  
Telangana State

Head of the Department  
Electronics and Communication Engineering  
Vignan's Institute of Management & Technology For Women  
Kondapur (V), Ghatkesar (M), Medchal - Malkajgiri (D) - 501 301  
Telangana State



# VIGNAN'S INSTITUTE OF MANAGEMENT AND TECHNOLOGY FOR WOMEN

Sponsored by Luvv Educational Society, Approved by AICTE, New Delhi & Affiliated to INTUW, Hyderabad  
Kondapur (V), Ghatkesar (M), Medchal - Malkajgiri (D) - 501 301 TS INDIA  
Phone: +0815 200006/07/08 Email: info@vnmw.in

## DEPARTMENT OF ELECTRONICS AND COMMUNICATION ENGINEERING

ADD ON COURSE NAME: Latest trends in chip design for Area and Power Optimization

Academic Year: 2017-18

Date: 30-08-2017

B.Tech III-I SEM

DAY WISE ATTENDANCE SHEET

SECTION: ECE-B

S.No	Roll number	30-Aug-17	31-Aug-17	1-Sep-17	2-Sep-17	4-Sep-17
1	15UPIA0443	Mona	Mona	Mona	Mona	Mona
2	15UPIA0444	Ket	keo	Ket	Ket	ket
3	15UPIA0445	Praya	Praya	Praya	Praya	Praya
4	15UPIA0447	Bharathi	Bharathi	Bharathi	Bharathi	Bharathi
5	15UPIA0448	Ravali	Ravali	Ravali	Ravali	Ravali
6	15UPIA0449	Srua	Srua	Srua	Srua	Srua
7	15UPIA0450	Jashna	Jashna	Jashna	Jashna	Jashna
8	15UPIA0451	Srinikitha	Srinikitha	Srinikitha	Srinikitha	Srinikitha
9	15UPIA0452	Ce	Ce	Ce	AB	Ce
10	15UPIA0453	Mounika	Mounika	Mounika	Mounika	Mounika
11	15UPIA0454	K.Rul	K.Rul	K.Rul	K.Rul	K.Rul
12	15UPIA0455	Kanya	Kanya	Kanya	Kanya	Kanya
13	15UPIA0456	Shay	Shay	Shay	Shay	Shay
14	15UPIA0457	Se	Se	Se	Se	Se
15	15UPIA0459	Raniya	Raniya	Raniya	Raniya	Raniya
16	15UPIA0460	Srinija	Srinija	Srinija	Srinija	Srinija
17	15UPIA0461	S	S	S	S	S
18	15UPIA0462	Chandana	Chandana	Chandana	Chandana	Chandana
19	15UPIA0463	Am	Am	Am	Am	Am
20	15UPIA0464	Shiba	Shiba	Shiba	Shiba	Shiba
21	15UPIA0465	Pravalika	Pravalika	Pravalika	Pravalika	Pravalika
22	15UPIA0466	Srav	Srav	Srav	Srav	Srav
23	15UPIA0467	Pr	Pr	Pr	Pr	Pr
24	15UPIA0468	Pr	Pr	Pr	Pr	Pr
25	15UPIA0471	Kanya	Kanya	Kanya	Kanya	Kanya
26	15UPIA0472	Priz	Priz	Priz	Priz	Priz
27	15UPIA0473	Mans	Mans	Mans	Mans	Mans
28	15UPIA0474	Pr	Pr	Pr	Pr	Pr
29	15UPIA0475	Pr	Pr	Pr	Pr	Pr
30	15UPIA0476	Nay	Nay	Nay	Nay	Nay
31	15UPIA0477	K	K	K	K	K
32	15UPIA0478	Mahathi	Mahathi	Mahathi	Mahathi	Mahathi
33	15UPIA0480	V.Pul	V.Pul	V.Pul	V.Pul	V.Pul
34	16UP5A0401	Riya	Riya	Riya	Riya	Riya
35	15C31A0432	AB	Pr	Pr	Pr	Pr

*[Signature]*  
COORDINATOR

*[Signature]*  
HOD



*[Signature]*  
PRINCIPAL

Head of the Department  
Electronics and Communication Engineering  
Vignans Institute of Management & Technology for Women  
Kondapur(V), Ghatkesar(M), Medchal-Malkajgiri(D)-501301  
Telangana State





# VIGNAN'S INSTITUTE OF MANAGEMENT AND TECHNOLOGY FOR WOMEN

Sponsored by Laxmi Educational Society, Approved by AICTE, New Delhi & Affiliated to JNTU, Hyderabad.  
Kondapur (V), Ghatkesar (M), Medchal - Malkajgiri (D) - 501 301 TS INDIA  
Phone: +08515 200006/07/08 Email: info@vmtw.in

## DEPARTMENT OF ELECTRONICS AND COMMUNICATION ENGINEERING

ADD ON COURSE NAME: Latest trends in chip design for Area and Power Optimization

Academic Year: 2017-18

Date: 05-09-2017

B.Tech III-I SEM

DAY WISE ATTENDANCE SHEET

SECTION: ECE-A

S.No	Roll Number	5-Sep-17	6-Sep-17	7-Sep-17	8-Sep-17	09-Sep-17
1	15UPIA0401	Mst	Mst	Mst	Mst	Mst
2	15UPIA0402	Vasude	Vasude	Vasude	Vasude	Vasude
3	15UPIA0403	Laxmi	Laxmi	Laxmi	Laxmi	Laxmi
4	15UPIA0405	Rachana	Rachana	Rachana	Rachana	Rachana
5	15UPIA0406	Ranya	Ranya	Ranya	Ranya	Ranya
6	15UPIA0407	Arjuni	Arjuni	Arjuni	Arjuni	Arjuni
7	15UPIA0408	H	H	H	H	H
8	15UPIA0409	Preethi	Preethi	Preethi	Preethi	Preethi
9	15UPIA0410	Alekhy	Alekhy	Alekhy	Alekhy	Alekhy
10	15UPIA0412	Vishwadevi	Vishwadevi	Vishwadevi	Vishwadevi	Vishwadevi
11	15UPIA0414	Harsha	Harsha	Harsha	Harsha	Harsha
12	15UPIA0415	Manika	Manika	Manika	Manika	Manika
13	15UPIA0416	Devika	Devika	Devika	Devika	Devika
14	15UPIA0417	Shravan	Shravan	Shravan	Shravan	Shravan
15	15UPIA0418	Haripriya	Haripriya	Haripriya	Haripriya	Haripriya
16	15UPIA0419	Pranya	Pranya	Pranya	Pranya	Pranya
17	15UPIA0420	Tejas	Tejas	Tejas	Tejas	Tejas
18	15UPIA0421	Nikhitha	Nikhitha	Nikhitha	Nikhitha	Nikhitha
19	15UPIA0422	Lina	Lina	Lina	Lina	Lina
20	15UPIA0423	Pooja	Pooja	Pooja	Pooja	Pooja
21	15UPIA0424	Sai Krupa	Sai Krupa	Sai Krupa	Sai Krupa	Sai Krupa
22	15UPIA0425	K. Sonid	K. Sonid	K. Sonid	K. Sonid	K. Sonid
23	15UPIA0426	Vijetha	Vijetha	Vijetha	Vijetha	Vijetha
24	15UPIA0427	Nikhitha	Nikhitha	Nikhitha	Nikhitha	Nikhitha
25	15UPIA0429	Pallavi	Pallavi	Pallavi	Pallavi	Pallavi
26	15UPIA0430	Kavani	Kavani	Kavani	Kavani	Kavani
27	15UPIA0431	Hikanti	Hikanti	Hikanti	Hikanti	Hikanti
28	15UPIA0432	Vikasini	Vikasini	Vikasini	Vikasini	Vikasini
29	15UPIA0434	Kavya	Kavya	Kavya	Kavya	Kavya
30	15UPIA0435	Bhavana	Bhavana	Bhavana	Bhavana	Bhavana
31	15UPIA0436	Vidya	Vidya	Vidya	Vidya	Vidya
32	15UPIA0437	Ranya	Ranya	Ranya	Ranya	Ranya
33	15UPIA0438	Vashti	Vashti	Vashti	Vashti	Vashti
34	15UPIA0439	Vashti	Vashti	Vashti	Vashti	Vashti
35	15UPIA0441	Swetha	Swetha	Swetha	Swetha	Swetha
36	15UPIA0442	Arjuna	Arjuna	Arjuna	Arjuna	Arjuna

*Ajarendy*  
COORDINATOR

*[Signature]*  
HOD

Head of the Department

Electronics and Communication Engineering  
Vignans Institute of Management & Technology For Women  
Kondapur (V), Ghatkesar (M), Medchal - Malkajgiri (D) - 501301

*[Signature]*

PRINCIPAL

Vignans Institute of Management & Technology For Women  
Kondapur (V), Ghatkesar (M), Medchal - Malkajgiri (D) - 501301  
Telangana State





# VIGNAN'S INSTITUTE OF MANAGEMENT AND TECHNOLOGY FOR WOMEN

Sponsored by Laxmi Educational Society, Approved by AICTE, New Delhi & Affiliated to JNTUH, Hyderabad.  
Kondapur (V), Ghatkesar (M), Medchal - Malkajgiri (D) - 501 301 TS INDIA  
Phone: +08615 200006/07/08 Email: info@vmtw.in

## DEPARTMENT OF ELECTRONICS AND COMMUNICATION ENGINEERING

ADD ON COURSE NAME: Latest trends in chip design for Area and Power Optimization

Academic Year: 2017-18

Date: 05-09-2017

B.Tech III-I SEM

DAY WISE ATTENDANCE SHEET

SECTION: ECE-B

S.No	Roll Number	5-Sep-17	6-Sep-17	7-Sep-17	8-Sep-17	09-Sep-17
1	15UP1A0443	Mana	Mana	Mana	Mana	Mana
2	15UP1A0444	Kee	Kee	Kee	Kee	Kee
3	15UP1A0445	Riya	Riya	Riya	Riya	Riya
4	15UP1A0447	Bharathi	Bharathi	Bharathi	Bharathi	Bharathi
5	15UP1A0448	Ravali	Ravali	Ravali	Ravali	Ravali
6	15UP1A0449	Sua	Sua	Sua	Sua	Sua
7	15UP1A0450	Jashna	Jashna	Jashna	Jashna	Jashna
8	15UP1A0451	Smitika	Smitika	Smitika	Smitika	Smitika
9	15UP1A0452	Ce	Ce	Ce	AB	Ce
10	15UP1A0453	Mounika	Mounika	Mounika	Mounika	Mounika
11	15UP1A0454	K.Raj	K.Raj	K.Raj	K.Raj	K.Raj
12	15UP1A0455	Kavya	Kavya	Kavya	Kavya	Kavya
13	15UP1A0456	Shay	Shay	Shay	Shay	Shay
14	15UP1A0457	So	So	So	So	So
15	15UP1A0459	Ramya	Ramya	Ramya	Ramya	Ramya
16	15UP1A0460	Seiya	Seiya	Seiya	Seiya	Seiya
17	15UP1A0461	S	S	S	S	S
18	15UP1A0462	Chandana	Chandana	Chandana	Chandana	Chandana
19	15UP1A0463	Shila	Shila	Shila	Shila	Shila
20	15UP1A0464	Shila	Shila	Shila	Shila	Shila
21	15UP1A0465	Pravalika	Pravalika	Pravalika	Pravalika	Pravalika
22	15UP1A0466	Swas	Swas	Swas	Swas	Swas
23	15UP1A0467	Ya	Ya	Ya	Ya	Ya
24	15UP1A0468	Abh	Abh	Abh	Abh	Abh
25	15UP1A0471	Kavya	Kavya	Kavya	Kavya	Kavya
26	15UP1A0472	Prish	Prish	Prish	Prish	Prish
27	15UP1A0473	Manas	Manas	Manas	Manas	Manas
28	15UP1A0474	Rany	Rany	Rany	Rany	Rany
29	15UP1A0475	S. Prityanta	S. Prityanta	S. Prityanta	S. Prityanta	S. Prityanta
30	15UP1A0476	Nat	Nat	Nat	Nat	Nat
31	15UP1A0477	Lo	Lo	Lo	Lo	Lo
32	15UP1A0478	AB	Mahathi	Mahathi	Mahathi	Mahathi
33	15UP1A0480	V.Puf	V.Puf	V.Puf	V.Puf	V.Puf
34	16UP5A0401	Riya	Riya	Riya	Riya	Riya
35	15C31A0432	Pa	Pa	Pa	Pa	Pa

*Abhinav*  
COORDINATOR

*AB*  
HOD



*AN*  
PRINCIPAL

Vignans Institute of Management & Technology For Women  
Kondapur (V), Ghatkesar (M), Medchal - Malkajgiri (D) - 501 301  
Telangana State

Head of the Department  
Electronics and Communication Engineering  
Vignans Institute of Management & Technology For Women  
Kondapur (V), Ghatkesar (M), Medchal - Malkajgiri (D) - 501 301



# VIGNAN'S INSTITUTE OF MANAGEMENT AND TECHNOLOGY FOR WOMEN

Sponsored by Lawu Educational Society, Approved by AICTE, New Delhi & Affiliated to JNTU, Hyderabad.  
Kondapur (V), Ghatkesar (M), Medchal - Malkajgiri (D) - 501 301 TS INDIA  
Phone: +08615 200096/07/08 Email: info@vmtw.in

## DEPARTMENT OF ELECTRONICS AND COMMUNICATION ENGINEERING

ADD ON COURSE NAME: Latest trends in chip design for Area and Power Optimization

Academic Year: 2017-18

Date: 11-09-2017

B.Tech III-I SEM

DAY WISE ATTENDANCE SHEET

SECTION: ECE-A

S.No	Roll Number	11-Sep-17	12-Sep-17	13-Sep-17	14-Sep-17	15-Sep-17
1	15UPIA0401	Miyu	Miyu	Miyu	Miyu	Miyu
2	15UPIA0402	Vastha	Vastha	Vastha	Vastha	Vastha
3	15UPIA0403	Laxmi	Laxmi	Laxmi	Laxmi	Laxmi
4	15UPIA0405	Rashmi	Rashmi	Rashmi	Rashmi	Rashmi
5	15UPIA0406	Ramya	Ramya	Ramya	Ramya	Ramya
6	15UPIA0407	Arjati	Arjati	Arjati	Arjati	Arjati
7	15UPIA0408	Rt	Rt	Rt	Rt	Rt
8	15UPIA0409	Poothi	Poothi	Poothi	Poothi	Poothi
9	15UPIA0410	Alekhyas	Alekhyas	Alekhyas	Alekhyas	Alekhyas
10	15UPIA0412	Vishuvasi	Vishuvasi	Vishuvasi	Vishuvasi	Vishuvasi
11	15UPIA0414	Himaja	Himaja	Himaja	Himaja	Himaja
12	15UPIA0415	Manika	Manika	Manika	Manika	Manika
13	15UPIA0416	Devika	Devika	Devika	Devika	Devika
14	15UPIA0417	Shravani	Shravani	Shravani	Shravani	Shravani
15	15UPIA0418	Haripriya	Haripriya	Haripriya	Haripriya	Haripriya
16	15UPIA0419	Pranaya	Pranaya	Pranaya	Pranaya	Pranaya
17	15UPIA0420	Tejasvi	Tejasvi	Tejasvi	Tejasvi	Tejasvi
18	15UPIA0421	Nikhitha	Nikhitha	Nikhitha	Nikhitha	Nikhitha
19	15UPIA0422	Ilma	Ilma	Ilma	Ilma	Ilma
20	15UPIA0423	Pooj	Pooj	Pooj	Pooj	Pooj
21	15UPIA0424	Sai Krupa	Sai Krupa	Sai Krupa	Sai Krupa	Sai Krupa
22	15UPIA0425	K.Sonia	K.Sonia	K.Sonia	K.Sonia	K.Sonia
23	15UPIA0426	Vijitha	Vijitha	Vijitha	Vijitha	Vijitha
24	15UPIA0427	Nikhitha	Nikhitha	Nikhitha	Nikhitha	Nikhitha
25	15UPIA0429	Pallavi	Pallavi	Pallavi	Pallavi	Pallavi
26	15UPIA0430	Kaveri	Kaveri	Kaveri	Kaveri	Kaveri
27	15UPIA0431	Shikha	Shikha	Shikha	Shikha	Shikha
28	15UPIA0432	Vikasini	Vikasini	Vikasini	Vikasini	Vikasini
29	15UPIA0434	Kavya	Kavya	Kavya	Kavya	Kavya
30	15UPIA0435	Bhavana	Bhavana	Bhavana	Bhavana	Bhavana
31	15UPIA0436	Vidya	Vidya	Vidya	Vidya	Vidya
32	15UPIA0437	Ramya	Ramya	Ramya	Ramya	Ramya
33	15UPIA0438	Vaishali	Vaishali	Vaishali	Vaishali	Vaishali
34	15UPIA0439	Vaishni	Vaishni	Vaishni	Vaishni	Vaishni
35	15UPIA0441	Sarthi	Sarthi	Sarthi	Sarthi	Sarthi
36	15UPIA0442	Anshu	Anshu	Anshu	Anshu	Anshu

*A. Naranda*  
COORDINATOR

*Et*  
HOD



*A. Anand*  
PRINCIPAL

Vignans Institute of Management & Technology for Women  
Kondapur (V), Ghatkesar (M), Medchal - Malkajgiri (D) - 501301  
Telangana State



# VIGNAN'S INSTITUTE OF MANAGEMENT AND TECHNOLOGY FOR WOMEN

Sponsored by Laxmi Educational Society, Approved by AICTE, New Delhi & Affiliated to JNTU, Hyderabad.  
Kondapur (V), Ghatkesar (M), Medchal - Malkajgiri (D) - 501 301 TS INDIA  
Phone: +08615 20006/07/08 Email: info@vmtw.in

## DEPARTMENT OF ELECTRONICS AND COMMUNICATION ENGINEERING

ADD ON COURSE NAME: Latest trends in chip design for Area and Power Optimization

Academic Year: 2017-18

Date: 11-09-2017

B.Tech III-I SEM

DAY WISE ATTENDANCE SHEET

SECTION: ECE-B

S.No	Roll Number	11-Sep-17	12-Sep-17	13-Sep-17	14-Sep-17	15-Sep-17
1	15UPIA0443	Alana	Alana	Alana	Alana	Alana
2	15UPIA0444	Kee	Kee	Kee	Kee	Kee
3	15UPIA0445	Priya	Priya	Priya	Priya	Priya
4	15UPIA0447	Isharathi	Isharathi	Isharathi	Isharathi	Isharathi
5	15UPIA0448	Ravali	Ravali	Ravali	Ravali	Ravali
6	15UPIA0449	Suwa	Suwa	Suwa	Suwa	Suwa
7	15UPIA0450	Joshna	Joshna	Joshna	Joshna	Joshna
8	15UPIA0451	Swikitha	Swikitha	Swikitha	Swikitha	Swikitha
9	15UPIA0452	Ce	Ce	Ce	Ce	Ce
10	15UPIA0453	Mounika	Mounika	Mounika	Mounika	Mounika
11	15UPIA0454	K.Pul	K.Pul	K.Pul	K.Pul	K.Pul
12	15UPIA0455	Kavya	Kavya	Kavya	Kavya	Kavya
13	15UPIA0456	Saaya	Saaya	Saaya	Saaya	Saaya
14	15UPIA0457	So	So	So	So	So
15	15UPIA0459	Ranya	Ranya	Ranya	Ranya	Ranya
16	15UPIA0460	Seena	Seena	Seena	Seena	Seena
17	15UPIA0461	S	S	S	S	A
18	15UPIA0462	Chandana	Chandana	Chandana	Chandana	Chandana
19	15UPIA0463	Shilpa	Shilpa	Shilpa	Shilpa	Shilpa
20	15UPIA0464	Shilpa	Shilpa	Shilpa	Shilpa	Shilpa
21	15UPIA0465	Pravalika	Pravalika	Pravalika	Pravalika	Pravalika
22	15UPIA0466	Smita	Smita	Smita	Smita	Smita
23	15UPIA0467	Uu	Uu	Uu	Uu	Uu
24	15UPIA0468	Uu	Uu	Uu	Uu	Uu
25	15UPIA0471	Kavya	Kavya	Kavya	Kavya	Kavya
26	15UPIA0472	Priya	Priya	Priya	Priya	Priya
27	15UPIA0473	Mansi	Mansi	Mansi	Mansi	Mansi
28	15UPIA0474	Mansi	Mansi	Mansi	Mansi	Mansi
29	15UPIA0475	Priyanka	Priyanka	Priyanka	Priyanka	Priyanka
30	15UPIA0476	Nat	Nat	Nat	Nat	Nat
31	15UPIA0477	Lo	Lo	Lo	Lo	Lo
32	15UPIA0478	Mahathi	Mahathi	Mahathi	Mahathi	Mahathi
33	15UPIA0480	V.Pul	V.Pul	V.Pul	V.Pul	V.Pul
34	16UPSA0401	Priya	Priya	Priya	Priya	Priya
35	15C31A0432	Pa	Pa	Pa	Pa	Pa

*[Signature]*  
COORDINATOR

*[Signature]*  
HOD



*[Signature]*  
PRINCIPAL

Head of the Department  
Electronics and Communication Engineering  
Vignans Institute of Management & Technology For Women

Vignans Institute of Management & Technology For Women  
Kondapur(V), Ghatkesar(M), Medchal-Malkajgiri(D)-501301  
Telangana State



# VIGNAN'S INSTITUTE OF MANAGEMENT AND TECHNOLOGY FOR WOMEN

Sponsored by Laxmi Educational Society, Approved by AICTE, New Delhi & Affiliated to JNTU, Hyderabad.  
 Kondapur (V), Ghatkesar (M), Medchal - Malkajgiri (D) - 501 301 TS INDIA  
 Phone: +08815 20006/07/08 Email: info@vmtw.in

## DEPARTMENT OF ELECTRONICS AND COMMUNICATION ENGINEERING

ADD ON COURSE NAME: Latest trends in chip design for Area and Power Optimization

Academic Year: 2017-18

Date: 16-09-2017

B.Tech III-I SEM

DAY WISE ATTENDANCE SHEET

SECTION: ECE-A

No	Roll Number	16-Sep-17	18-Sep-17	19-Sep-17	20-Sep-17	21-Sep-17
1	15UPIA0401	Rishi	Rishi	Rishi	Rishi	Rishi
2	15UPIA0402	Varsha	Varsha	Varsha	Varsha	Varsha
3	15UPIA0403	Laxmi	Laxmi	Laxmi	Laxmi	Laxmi
4	15UPIA0405	Pooja	Pooja	Pooja	Pooja	Pooja
5	15UPIA0406	Ramya	Ramya	Ramya	Ramya	Ramya
6	15UPIA0407	Anjali	Anjali	Anjali	Anjali	Anjali
7	15UPIA0408	Et	Et	Et	Et	Et
8	15UPIA0409	Preethi	Preethi	Preethi	Preethi	Preethi
9	15UPIA0410	Alekhyas	Alekhyas	Alekhyas	Alekhyas	Alekhyas
10	15UPIA0412	Vishnu	Vishnu	Vishnu	Vishnu	Vishnu
11	15UPIA0414	Hirani	Hirani	Hirani	Hirani	Hirani
12	15UPIA0415	Mounika	Mounika	Mounika	Mounika	Mounika
13	15UPIA0416	Devika	Devika	Devika	Devika	Devika
14	15UPIA0417	Shravan	Shravan	Shravan	Shravan	Shravan
15	15UPIA0418	Harpriya	Harpriya	Harpriya	Harpriya	Harpriya
16	15UPIA0419	Priyanka	Priyanka	Priyanka	Priyanka	Priyanka
17	15UPIA0420	Tajashree	Tajashree	Tajashree	Tajashree	Tajashree
18	15UPIA0421	Nikhitha	Nikhitha	Nikhitha	Nikhitha	Nikhitha
19	15UPIA0422	Ilma	Ilma	Ilma	Ilma	Ilma
20	15UPIA0423	Pooj	Pooj	Pooj	Pooj	Pooj
21	15UPIA0424	Sai Krupa	Sai Krupa	Sai Krupa	Sai Krupa	Sai Krupa
22	15UPIA0425	K. Sania	K. Sania	K. Sania	K. Sania	K. Sania
23	15UPIA0426	Vijitha	Vijitha	Vijitha	Vijitha	Vijitha
24	15UPIA0427	Nikhitha	Nikhitha	Nikhitha	Nikhitha	Nikhitha
25	15UPIA0429	Pallavi	Pallavi	Pallavi	Pallavi	Pallavi
26	15UPIA0430	Kavani	Kavani	Kavani	Kavani	Kavani
27	15UPIA0431	Lakshmi	Lakshmi	Lakshmi	Lakshmi	Lakshmi
28	15UPIA0432	Vikasini	Vikasini	Vikasini	Vikasini	Vikasini
29	15UPIA0434	Kavya	Kavya	Kavya	Kavya	Kavya
30	15UPIA0435	Bhavana	Bhavana	Bhavana	Bhavana	Bhavana
31	15UPIA0436	Vidya	Vidya	Vidya	Vidya	Vidya
32	15UPIA0437	Ramya	Ramya	Ramya	Ramya	Ramya
33	15UPIA0438	Vaishali	Vaishali	Vaishali	Vaishali	Vaishali
34	15UPIA0439	Yashini	Yashini	Yashini	Yashini	Yashini
35	15UPIA0441	Swetha	Swetha	Swetha	Swetha	Swetha
36	15UPIA0442	Anshu	Anshu	Anshu	Anshu	Anshu



HOD

PRINCIPAL Head of the Department  
 Electronics and Communication Engineering  
 Vignans Institute of Management & Technology For Women  
 Kondapur(V), Ghatkesar(M), Medchal-Malkajgiri(D)-501301  
 Telangana State



# VIGNAN'S INSTITUTE OF MANAGEMENT AND TECHNOLOGY FOR WOMEN

Sponsored by Laxmi Educational Society, Approved by AICTE, New Delhi & Affiliated to JNTUH, Hyderabad.  
 Kondapur (V), Ghatkesar (M), Medchal - Malkajgiri (D) - 501 301 TS INDIA  
 Phone: +09615 20006/07/08 Email: info@vmtw.in

## DEPARTMENT OF ELECTRONICS AND COMMUNICATION ENGINEERING

ADD ON COURSE NAME: Latest trends in chip design for Area and Power Optimization

Academic Year: 2017-18

Date: 16-09-2017

B.Tech III-I SEM

DAY WISE ATTENDANCE SHEET

SECTION: ECE-B

S.No	Roll Number	16-Sep-17	18-Sep-17	19-Sep-17	20-Sep-17	21-Sep-17
1	15UPIA0443	<del>Para</del>	<del>Para</del>	<del>Para</del>	<del>Para</del>	<del>Para</del>
2	15UPIA0444	ke	ke	ke	ke	ke
3	15UPIA0445	kaifa	kaifa	kaifa	kaifa	kaifa
4	15UPIA0447	Isharathi	Isharathi	Isharathi	Isharathi	Isharathi
5	15UPIA0448	Ravali	Ravali	Ravali	Ravali	Ravali
6	15UPIA0449	Sua	Sua	Sua	Sua	Sua
7	15UPIA0450	Jashna	Jashna	Jashna	Jashna	Jashna
8	15UPIA0451	sunitha	sunitha	sunitha	sunitha	sunitha
9	15UPIA0452	C	C	C	C	C
10	15UPIA0453	Mounika	Mounika	Mounika	Mounika	Mounika
11	15UPIA0454	K.Ruf	K.Ruf	K.Ruf	K.Ruf	K.Ruf
12	15UPIA0455	kaaya	kaaya	kaaya	kaaya	kaaya
13	15UPIA0456	kaaya	kaaya	kaaya	kaaya	kaaya
14	15UPIA0457	sa	sa	sa	sa	sa
15	15UPIA0459	Ramya	Ramya	Ramya	Ramya	Ramya
16	15UPIA0460	saaya	saaya	saaya	saaya	saaya
17	15UPIA0461	S	S	S	S	S
18	15UPIA0462	Chandana	Chandana	Chandana	Chandana	Chandana
19	15UPIA0463	shila	shila	shila	shila	shila
20	15UPIA0464	shila	shila	shila	shila	shila
21	15UPIA0465	Pravalika	Pravalika	Pravalika	Pravalika	Pravalika
22	15UPIA0466	Sraas	Sraas	Sraas	Sraas	Sraas
23	15UPIA0467	Sraas	Sraas	Sraas	Sraas	Sraas
24	15UPIA0468	kaaya	kaaya	kaaya	kaaya	kaaya
25	15UPIA0471	kaaya	kaaya	kaaya	kaaya	kaaya
26	15UPIA0472	paiba	paiba	paiba	paiba	paiba
27	15UPIA0473	paiba	paiba	paiba	paiba	paiba
28	15UPIA0474	naas	naas	naas	naas	naas
29	15UPIA0475	naas	naas	naas	naas	naas
30	15UPIA0476	naas	naas	naas	naas	naas
31	15UPIA0477	naas	naas	naas	naas	naas
32	15UPIA0478	maahathi	maahathi	maahathi	AE	maahathi
33	15UPIA0480	v.e.d	v.e.d	v.e.d	v.e.d	v.e.d
34	16UP5A0401	Riya	Riya	Riya	Riya	Riya
35	15C31A0432	pa	pa	pa	pa	pa

*Jainaba*  
COORDINATOR

*AB*  
HOD



*Vignans*  
PRINCIPAL

Vignans Institute of Management & Technology For Women  
 Kondapur (V), Ghatkesar (M), Medchal-Malkajgiri (D) - 501301  
 Telangana State

Head of the Department  
 Electronics and Communication Engineering  
 Vignans Institute of Management & Technology For Women  
 Kondapur (V), Ghatkesar (M), Medchal-Malkajgiri (D) - 501301  
 Telangana State



# VIGNAN'S INSTITUTE OF MANAGEMENT AND TECHNOLOGY FOR WOMEN

Sponsored by Laxmi Educational Society, Approved by AICTE, New Delhi & Affiliated to JNTU, Hyderabad.  
Kondapur (V), Ghafkisar (M), Medchal - Malkajgiri (D) - 501 301 TS INDIA  
Phone: +08615 200006/07/08 Email: info@vmbw.in

## DEPARTMENT OF ELECTRONICS AND COMMUNICATION ENGINEERING

ADD ON COURSE NAME: Latest trends in chip design for Area and Power Optimization

Academic Year: 2017-18

Date: 22-09-2017

B.Tech III-I SEM

DAY WISE ATTENDANCE SHEET

SECTION: ECE-A

S.No	Roll Number	22-Sep-17	23-Sep-17	25-Sep-17	26-Sep-17	27-Sep-17
1	15UPIA0401	M.S.J	M.S.J	M.S.J	M.S.J	M.S.J
2	15UPIA0402	Vaishya	Vaishya	Vaishya	Vaishya	Vaishya
3	15UPIA0403	Laxmi	Laxmi	Laxmi	Laxmi	Laxmi
4	15UPIA0405	Rachana	Rachana	Rachana	Rachana	Rachana
5	15UPIA0406	Ranya	Ranya	Ranya	Ranya	Ranya
6	15UPIA0407	Anjali	Anjali	Anjali	Anjali	Anjali
7	15UPIA0408	R	R	R	R	R
8	15UPIA0409	Poothi	Poothi	Poothi	Poothi	Poothi
9	15UPIA0410	Alekhyas	Alekhyas	Alekhyas	Alekhyas	Alekhyas
10	15UPIA0412	Vyshnavi	Vyshnavi	Vyshnavi	Vyshnavi	Vyshnavi
11	15UPIA0414	Himaja	Himaja	Himaja	Himaja	Himaja
12	15UPIA0415	Harshika	Harshika	Harshika	Harshika	Harshika
13	15UPIA0416	Devika	Devika	Devika	Devika	Devika
14	15UPIA0417	Sarvani	Sarvani	Sarvani	Sarvani	Sarvani
15	15UPIA0418	Harpriya	Harpriya	Harpriya	Harpriya	Harpriya
16	15UPIA0419	Pranshi	Pranshi	Pranshi	Pranshi	Pranshi
17	15UPIA0420	Tejasvi	Tejasvi	Tejasvi	Tejasvi	Tejasvi
18	15UPIA0421	Nikhitha	Nikhitha	Nikhitha	Nikhitha	Nikhitha
19	15UPIA0422	Ilme	Ilme	Ilme	Ilme	Ilme
20	15UPIA0423	Pooja	Pooja	Pooja	Pooja	Pooja
21	15UPIA0424	Sai Krupa	Sai Krupa	Sai Krupa	Sai Krupa	Sai Krupa
22	15UPIA0425	K.Sonia	K.Sonia	K.Sonia	K.Sonia	K.Sonia
23	15UPIA0426	Vijetha	Vijetha	Vijetha	Vijetha	Vijetha
24	15UPIA0427	Nikhitha	Nikhitha	Nikhitha	Nikhitha	Nikhitha
25	15UPIA0429	Pallavi	Pallavi	Pallavi	Pallavi	Pallavi
26	15UPIA0430	Taruni	Taruni	Taruni	Taruni	Taruni
27	15UPIA0431	Nikhitha	Nikhitha	Nikhitha	Nikhitha	Nikhitha
28	15UPIA0432	Vikasini	Vikasini	Vikasini	Vikasini	Vikasini
29	15UPIA0434	Kavya	Kavya	Kavya	Kavya	Kavya
30	15UPIA0435	Bhavana	Bhavana	Bhavana	Bhavana	Bhavana
31	15UPIA0436	Vidya	Vidya	Vidya	Vidya	Vidya
32	15UPIA0437	Ranya	Ranya	Ranya	Ranya	Ranya
33	15UPIA0438	Vaishali	Vaishali	Vaishali	Vaishali	Vaishali
34	15UPIA0439	Vaishini	Vaishini	Vaishini	Vaishini	Vaishini
35	15UPIA0441	Sreetha	Sreetha	Sreetha	Sreetha	Sreetha
36	15UPIA0442	Arbana	Arbana	Arbana	Arbana	Arbana



**COORDINATOR**

**HOD**

**PRINCIPAL**

Vignani's Institute of Management & Technology For Women  
Kondapur (V), Ghafkisar (M), Medchal - Malkajgiri (D) - 501301  
Telangana State

Head of the Department  
Electronics and Communication Engineering  
Vignani's Institute of Management & Technology For Women  
Kondapur (V), Ghafkisar (M), Medchal - Malkajgiri (D) - 501301  
Telangana State



# VIGNAN'S INSTITUTE OF MANAGEMENT AND TECHNOLOGY FOR WOMEN

Sponsored by Laxmi Educational Society, Approved by AICTE, New Delhi & Affiliated to JNTUH, Hyderabad.  
Kondapur (V), Chhatkesar (M), Medchal - Malkajgiri (D) - 501 301 TS INDIA  
Phone: +0865 200006/07/08 Email: info@vmtw.in

## DEPARTMENT OF ELECTRONICS AND COMMUNICATION ENGINEERING

ADD ON COURSE NAME: Latest trends in chip design for Area and Power Optimization

Academic Year: 2017-18

Date: 22-09-2017

B.Tech III-I SEM

DAY WISE ATTENDANCE SHEET

SECTION: ECE-B

S.No	Roll Number	22-Sep-17	23-Sep-17	25-Sep-17	26-Sep-17	27-Sep-17
1	15UPIA0443	Mara	Mara	Mara	Mara	Mara
2	15UPIA0444	keo	keo	keo	keo	keo
3	15UPIA0445	Rajya	Rajya	Rajya	Rajya	Rajya
4	15UPIA0447	Bharathi	Bharathi	Bharathi	Bharathi	Bharathi
5	15UPIA0448	Ravali	Ravali	Ravali	Ravali	Ravali
6	15UPIA0449	Sua	Sua	Sua	Sua	Sua
7	15UPIA0450	Jashna	Jashna	Jashna	Jashna	Jashna
8	15UPIA0451	Siritha	Siritha	Siritha	Siritha	Siritha
9	15UPIA0452	Ce	Ce	Ce	Ce	Ce
10	15UPIA0453	Mounika	Mounika	Mounika	Mounika	Mounika
11	15UPIA0454	K.Raj	K.Raj	K.Raj	K.Raj	K.Raj
12	15UPIA0455	Kavya	Kavya	Kavya	Kavya	Kavya
13	15UPIA0456	Kavya	Kavya	Kavya	Kavya	Kavya
14	15UPIA0457	Se	Se	Se	Se	Se
15	15UPIA0459	Ramya	Ramya	Ramya	Ramya	Ramya
16	15UPIA0460	Sarjya	Sarjya	Sarjya	Sarjya	Sarjya
17	15UPIA0461	S	S	S	S	S
18	15UPIA0462	Chandana	Chandana	Chandana	Chandana	Chandana
19	15UPIA0463	Sat	Sat	Sat	Sat	Sat
20	15UPIA0464	Shiva	Shiva	Shiva	Shiva	Shiva
21	15UPIA0465	Pravalika	Pravalika	Pravalika	Pravalika	Pravalika
22	15UPIA0466	Sravya	Sravya	Sravya	Sravya	Sravya
23	15UPIA0467	Usha	Usha	Usha	Usha	Usha
24	15UPIA0468	Abhis	Abhis	Abhis	Abhis	Abhis
25	15UPIA0471	Kavya	Kavya	Kavya	Kavya	Kavya
26	15UPIA0472	Priya	Priya	Priya	Priya	Priya
27	15UPIA0473	Manu	Manu	Manu	Manu	Manu
28	15UPIA0474	Ramya	Ramya	Ramya	Ramya	Ramya
29	15UPIA0475	Sriyanka	Sriyanka	Sriyanka	Sriyanka	Sriyanka
30	15UPIA0476	Nal	Nal	Nal	Nal	Nal
31	15UPIA0477	De	De	De	De	De
32	15UPIA0478	mahathi	mahathi	mahathi	mahathi	mahathi
33	15UPIA0480	V.Raj	V.Raj	V.Raj	V.Raj	V.Raj
34	16UP5A0401	Divya	Divya	Divya	Divya	Divya
35	15C31A0432	Pr	Pr	Pr	Pr	Pr

*[Signature]*  
COORDINATOR

*[Signature]*  
HOD



*[Signature]*  
PRINCIPAL

Vignans Institute of Management & Technology For Women  
Kondapur(V), Chhatkesar(M), Medchal - Malkajgiri(D) - 501 301  
Telangana State

Head of the Department  
Electronics and Communication Engineering  
Vignans Institute of Management & Technology For Women  
Kondapur(V), Chhatkesar(M), Medchal - Malkajgiri(D) - 501 301  
Telangana State





# VIGNAN'S INSTITUTE OF MANAGEMENT AND TECHNOLOGY FOR WOMEN

Sponsored by Laxmi Educational Society, Approved by AICTE, New Delhi & Affiliated to JNTUH, Hyderabad.  
Kondapur (V), Ghatkesar (M), Medchal - Malkajgiri (D) - 501 301 TS INDIA  
Phone: +08615 200006/07/08 Email: info@vmtw.in

## DEPARTMENT OF ELECTRONICS AND COMMUNICATION ENGINEERING

Date: 29-09-2017

### PROGRAM REPORT

Name of the Add on Course: Latest trends in chip design for Area and Power Optimization

Day/Duration: 35 Hours

Time: 4pm to 5pm

Resource Person: Mr. ARJUN MODI, Technical Manager in AMTRONICS, Hyderabad

Name of the Coordinator: G. Narendra, Assistant Professor Dept. of ECE VMTW, Hyderabad

Number of the Participants: 71

**Topics covered:** The following topics covered in this program

1. Analog IC Design
2. Digital IC Design

### **Course Outcomes:**

COs	At the end of the course, students will have the ability to:	Pos Mapped	Strength of mapping
CO1	Develop mathematical models for modern MOS devices.	PO2,PO3	2
CO2	Develop solution to overcome short channel issues	PO3,PO4	3
CO3	Develop various compact models appropriate for industry.	PO3,PO4	2
CO4	Analyse current distribution in the devices like transistors, MOS devices.	PO2,PO4	2
CO5	Construct the circuit layout using the design rules	PO2,PO4	3

**Assessment Procedure:** The assessment of the Add on course is conducted in Multiple Choice Questions through offline Mode.

  
COORDINATOR

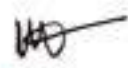

  
HOD  
Head of the Department  
Electronics and Communication Engineering  
Vignan's Institute of Management & Technology For Women,  
Kondapur (V), Ghatkesar (M), Medchal-Malkajgiri (D)-501301

PRINCIPAL  
Vignan's Institute of Management & Technology For Women  
Kondapur(V),Ghatkesar(M),Medchal-Malkajgiri(D)-501301  
Telangana State



# VIGNAN'S INSTITUTE OF MANAGEMENT AND TECHNOLOGY FOR WOMEN

Approved by AICTE, New Delhi & Affiliated to JNTUH, Hyderabad.  
Kondapur (V), Ghatkesar (M), Medchal - Malkajgiri (D) - 501 301

## Certificate of Course Completion

This is to certify that Ms./Mr. .... **GIUNDA DEVIKA** .....

Roll No. .... **15UPIA0416** ..... Year .... **III** .....

has successfully completed the Add-On / Certification Course on

..... **Latest Trends in chip design for Area and Power Optimization** .....

held from ..... **18-08-2017** ..... to ..... **27-09-2017** .....



At  
**HoD, ECE\***

Head of the Department

Electronics and Communication Engineering  
Vignans Institute of Management and Technology for Women  
Kondapur (V), Ghatkesar (M), R.R. Dist-501 301

*[Handwritten Signature]*  
PRINCIPAL

Vignans Institute of Management & Technology for Women  
Kondapur(V), Ghatkesar(M), Medchal-Malkajgiri(D)-501 301  
Telangana State

*[Handwritten Signature]*  
**Principal, VMTW**

PRINCIPAL

Vignans Institute of Management & Technology for Women  
Kondapur(V), Ghatkesar(M), Medchal-Malkajgiri(D)-501 301  
Telangana State



# VIGNAN'S INSTITUTE OF MANAGEMENT AND TECHNOLOGY FOR WOMEN

Sponsored by Lava Educational Society, Approved by AICTE, New Delhi & Affiliated to JNTU/H, Hyderabad.  
Kondapur (V), Ghatkesar (M), Medchal - Malkajgiri (D) - 501 301 TS INDIA  
Phone: +08615 200006/07/08 Email: info@vmtw.in

VMTW/CSE/Cir/2017-18/WP/07

Date: 23/08/2017

## CIRCULAR

This is to inform all the HODs, staff and students that there will be an Awareness program on "Fundamental Importance of Knowledge and Society" for III CSE students on 24/08/2017 by Mr Chaithanya Sharma at seminar hall. All the students are here by informed to assemble in the seminar hall by 10.15 AM and to attend Seminar hall and make it a successful one.

  
PRINCIPAL

Vignan's Institute of Management & Technology For Women  
Kondapur (V), Ghatkesar (M), Medchal-Malkajgiri (D) - 501301  
Telangana State

### Copy to:

1. CEO for information,
2. All Deans, HODs, Staff,
3. IQAC,
4. All Classrooms,
5. All Notice Board,
6. File.



  
PRINCIPAL

Vignan's Institute of Management & Technology For Women  
Kondapur (V), Ghatkesar (M), Medchal-Malkajgiri (D) - 501301  
Telangana State



# VIGNAN'S INSTITUTE OF MANAGEMENT AND TECHNOLOGY FOR WOMEN

Sponsored by Laxmi Educational Society, Approved by AICTE, New Delhi & Affiliated to JNTU, Hyderabad.  
Kondapur (V), Ghatkesar (M), Medchal - Malkajgiri (D) - 501 301 TS INDIA  
Phone: +08615 200006/07/08 Email: info@vignani.in

## Report on "Fundamental importance of Knowledge and society"

Date: 26-08-2017

Name of the program: Fundamental importance of Knowledge and society.

Name of the agency: Valmiki Foreign Education Services.

Date of Program: 24-08-2017

Number of Students attended: 103

Name of Trainers: Mr. Chaithanya sharma

Topics Covered: Career Planning & Career Development, Motivating Students, Development of overall Career goals and objectives, Effective communication, Time management.

Students gained the knowledge on Career Planning & [Career Development](#), Development of overall goals and objectives. The session was highly inspiring and around 103 students took part in it.

The session was conducted successfully with the coordination of the faculty members of computer Science and engineering.



  
Co-ordinator

  
PRINCIPAL  
Vignani's Institute of Management & Technology for Women  
Kondapur(V), Ghatkesar(M), Medchal, Malkajgiri(D), T.S.  
Telangana State

**4<sup>th</sup> Year CSE Attended students for the program**

S.No	Roll No	Name
1	13UPIA0552	POLAPALLI BHAVYA
2	14UPIA0501	BANOTH JYOTHSNA
3	14UPIA0502	N SAHARIKA
4	14UPIA0503	PITTALA SHRUTHI
5	14UPIA0504	P. SHRAVYA REDDY
6	14UPIA0506	REKULA VANI
7	14UPIA0507	SIDDIPETA JAYA
8	14UPIA0508	SINGI REDDY DIVYA

**3<sup>rd</sup> Year CSE Attended students for the program**

S.No	Roll No	Name
1	14UPIA0505	B. MEGHANA
2	15UPIA0501	A. HIMA RAJYALAKSHMI
3	15UPIA0502	BASUDE PREETHI
4	15UPIA0503	BAYYADUGULA PRAVEENA
5	15UPIA0504	B. TEJASVEE YADAV
6	15UPIA0505	BODIKA SANDHYA RANI
7	15UPIA0506	BOLLOJU RAMYA SMRUTHI
8	15UPIA0507	BOMMA AKHILA
9	15UPIA0508	BONTHU TARUNA SRI
10	15UPIA0509	BURUGU TEJASRI
11	15UPIA0510	CHENNALA GAYATRI YADAV
12	15UPIA0511	CHINDAM PRANAVA
13	15UPIA0512	CHOWDARAPU SRIJA
14	15UPIA0513	D. A. DIVYA
15	15UPIA0514	D. ANUSHA
16	15UPIA0515	DAMULURI DIVYA
17	15UPIA0517	DENDUKURU SRIREKHA
18	15UPIA0518	DHARNI MANISHA
19	15UPIA0519	G. VAISHNAVI
20	15UPIA0520	G. SUPRAJA CHINMAYEE
21	15UPIA0522	GULLIPALLI JAHNAVI
22	15UPIA0523	GUNDA SOWMYA
23	15UPIA0524	GURDEEP KAUR JANDU
24	15UPIA0525	K. ANUSHA
25	15UPIA0526	K. SHRUTHI
26	15UPIA0528	KAMBALAPALLY MOUNIKA
27	15UPIA0529	KOTIKA SIVA PARVATHI
28	15UPIA0530	KRISHNADHARI SOWJANYA
		M. DIGAMBER DEVKATTE



*[Signature]*  
**PRINCIPAL**  
 Vignan's Institute of Management & Technology For Women  
 Kondapur(V), Ghatkesar(M), Medchal-Malkajgiri(Dt)-501301  
 Telangana State

30	15UP1A0533	MARPU SWETHA REDDY
31	15UP1A0534	M. VENKATA NAGASWETHA
32	15UP1A0535	N NIHARIKA REDDY
33	15UP1A0536	NAKREKANTI PRASHANTHI
34	15UP1A0537	NERELLA TEJASWINI
35	15UP1A0538	PADMAM KRISHNAVENI
36	15UP1A0539	PANAGANTI MADHUSHALINI
37	15UP1A0540	POTHAM JYOSHNA DEVI
38	15UP1A0541	PULAMONI PRAVALIKA
39	15UP1A0542	PULGAM KAVYA
40	15UP1A0544	SARIKONDA POOJA
41	15UP1A0545	SRAVANI REDDY
42	15UP1A0546	SRI RAMA VINEETHA
43	15UP1A0547	SUNKARA SAIMOUNIKA
44	15UP1A0548	SUTHOJU SNEHA
45	15UP1A0549	SWARGAM MOUNIKA
46	15UP1A0550	THOUTAM CHANDANA
47	15UP1A0551	VALABOJU DIVYA SRI
48	15UP1A0552	AKULA VANAJA
49	15UP1A0553	AKUULA PRIYANKKA
50	15UP1A0554	ANANTHULA RAVALI
51	15UP1A0555	ANDAM SIRISHA
52	15UP1A0556	BANDI RASHMITHA
53	15UP1A0557	BAREDDY SRAVANTHI
54	15UP1A0559	BOPPIDI ROOPASRI
55	15UP1A0560	CHANDA VARALAXMI
56	15UP1A0561	CHATHELLI PRANAVI
57	15UP1A0562	CHIRABOINA RAMADEVI
58	15UP1A0563	CH. LAKSHMI PRIYA
59	15UP1A0564	DARIPALLI AMANI
60	15UP1A0565	EDUKULLA LIKITHA
61	15UP1A0567	GOPISETTY SAHAJA
62	15UP1A0568	K NAVA JYOTHI
63	15UP1A0569	KANDULA MANMITHA
64	15UP1A0570	KARLA AMULYA
65	15UP1A0571	L SONALI
66	15UP1A0572	MANDADI MOUNIKA
67	15UP1A0573	MARYALA DIKSHITHA
68	15UP1A0574	MENDE KAVYA
69	15UP1A0575	MIRYALA SRI LAKSHMI
70	15UP1A0576	MOOLA VIDYA SRI
71	15UP1A0577	N USHARANI
72	15UP1A0578	NANDINI BANDARU
		NANGUNURI NAVYA SRI



*[Signature]*  
PRINCIPAL

Vignana's Institute of Management & Technology For Women  
Kondapur (V), Ghatkesar (M), Medchal-Malkajgiri (D), 501301  
Telangana State

74	15UP1A0580	PENDYALA LASYA PRIYA
75	15UP1A0581	PININTI NIHARIKA REDDY
76	15UP1A0582	PUTTA DEEKSHITHA
77	15UP1A0583	RAMADEVI SEELAM
78	15UP1A0584	RAVALKOLE MANASA
79	15UP1A0585	RAVIRALA HARSHITHA
80	15UP1A0586	RELANGI VIJAYA DURGA
81	15UP1A0587	SAGIREDDY HEVANYA
82	15UP1A0588	SAMALA ANUSHA
83	15UP1A0589	SANTHAPURI VAISHNAVI
84	15UP1A0590	SOMA SHRUTHI
85	15UP1A0591	SUMREDDY ABHINAYA
86	15UP1A0592	SUNKARI SOWMYA REDDY
87	15UP1A0593	TALAPAREDDY SANGHAVI
88	15UP1A0594	THIRMANI BHAVANI
89	15UP1A0595	VEERANALA MANASA
90	15UP1A0596	VELAPATI SOWMYA
91	15UP1A0598	V. R. LAKSHMI KALYANI
92	15UP1A0599	VODDE DIVYA
93	15UP1A05A1	VOOTUKURY PRAVALLIKA
94	15UP1A05A2	VORUGANTI PRAVALLIKA
95	15UP1A05A3	MAHVEEN ARSHI



*2/2/21*  
**PRINCIPAL**  
**Vignans Institute of Management & Technology For Women**  
 Kondapur(V), Ghatkesar(M), Medchal-Malkajgiri(D)-501301  
 Telangana State



# VIGNAN'S INSTITUTE OF MANAGEMENT AND TECHNOLOGY FOR WOMEN

(Approved by AICTE, New Delhi & Affiliated to JNTUH, Hyderabad.)

Kondapur (V), Ghatkesar (M), Medchal - Malkajgiri (D) - 501 301

## INTERNAL QUALITY ASSURANCE CELL (IQAC)

ORGANIZING

# ORIENTATION PROGRAM ON MENTOR-MENTEE SYSTEM

9<sup>TH</sup> JULY, 2017 @ 11:30 AM

VENUE: ASF-2, A-BLOCK



Resource Person:

**Mr. Himagiri Danapana,**

Assistant Professor,  
Department of CSE,  
JBIET, Hyderabad.



Chief Patron:

**Dr. Lavu Rathaiah,**  
Chairman, Vignan Group.

Patron:

**Mr. B. Shraavan,**  
CEO, Vignan Group.

Co-Patron:

**Dr. P. Sudhakara Rao,**  
Principal, VMTW.

Advisor:

**Mr. P. Harikrishna,**  
Co-Ordinator, IQAC.

Program Co-Ordinator:

**Mrs. V. Suzan Shalini,**  
Assistant Professor, BS&H.  
Cell: +91 96529 10002



Date :07/07/2017

To

The Principal,

VMTW,Ghatkesar

Subject: Request for Orientation Program on Mentor-Mentee System

As a Co-ordinator of the Internal Quality Assurance Cell (IQAC) at our institution, I am writing to request the organization of an orientation program on the implementation of a mentor-mentee system on 09/07/17. An orientation program dedicated to the mentor-mentee system would serve as a valuable platform to introduce this initiative to the faculty, staff, and students.

IQAC is committed to promoting quality enhancement initiatives, I kindly request your support and consideration in organizing this orientation program.

Thank you Sir

Yours Sincerely

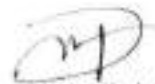

P.Harikrishna

Co-ordinator,IQAC

*Handwritten note:*  
Vignans  
Principal



PRINCIPAL

Vignans Institute of Management & Technology For Women  
Kondapur (V), Ghatkesar (M), Medchal-Malkajgiri (Dt)-501301  
Telangana State



**HIMAGIRI DANAPANA,**

M.Tech (SE),B.Tech (IT).

Department of Computer Science and Engineering,

Ph: +91 7095640111,

E-mail:himagiri.danapana@gmail.com



**WORK EXPERIENCE:**

- Having 7+ years of teaching experience.
- Working as Assistant Professor in J.B Institute of Engineering and Technology, Moinabad, Hyderabad, Telangana ,India-500075 from Jan 2012 to Till Date.

**STRENGTHS:**

- Qualified as Assistant Professor in National Eligibility Test conducted by University Grants Commission (UGC),India.
- Ratified as Assistant Professor by JNTU Hyderabad, India.
- Acted as a Student Counsellor/Mentor.
- BOS (Board of studies) member for CSE Department, JBIET.
- NBA criterion 3 Department Coordinator.
- Guided final year students and PG student's projects.
- Active participation in NBA & NACC work.
- Department JNTUH & AICET Coordinator.
- College MIS officer.
- Acted as an External Exam paper reviewer and paper evaluator.
- Involvement in curriculum updating and Design.
- Program Assessment Committee (PAC) Member.

**PUBLICATIONS:**

- Published a paper in IJRRECS with title " Design a context to tackle online Traffic Circumstances" IJRRECS Vol 4,Issue 9,Sept 2016 (ISSN2321-5461).
- Published a paper in International Journal for Computer Science and Technology with title "Effective Data Mining Association Rules for Heart Disease Prediction System" IJCSST Vol. 2, Issue 4, Oct. - Dec. 2011 (ISSN 2229-4333).



*Vignans*  
PRINCIPAL  
Vignans Institute of Management & Technology For Women  
Kondapur (V), Ghatkesar (M), Medchal-Malkajgiri (Dt)-501301  
Telangana State

### TRAINING AND FDPs:

- Attended Two days Faculty Development Program on "Significance of Outcome Based Education in achieving Excellency" conducted in JBIET from 21 and 22 April 2017.
- Participated in MeitY, Govt. of India sponsored One week Faculty Development Program on "Statistical Analysis with R" organized by the E&ICT Academy,NIT,Warangal at JBIET ,Hyderabad from 18th Mar-23th Mar 2017.
- Attended 5 days Faculty Development Program on : "Effective Teaching Methods & Best Practices "conducted in JBIET from 5-9 DEC 2016.



  
PRINCIPAL  
Vignani's Institute of Management & Technology For Women  
Kondapur (V), Ghatkesar (M), Medchal-Malkajgiri (Dt) 501301  
Telangana State



# VIGNAN'S INSTITUTE OF MANAGEMENT AND TECHNOLOGY FOR WOMEN

[Sponsored by Lavu Educational Society, Approved by AICTE, New Delhi & Affiliated to JNTUH, Hyderabad.]

Kondapur (V), Ghatkesar (M), Medchal - Malkajgiri (D) - 501 301 TS INDIA

Phone: +08415 200006/07/08

Email: info.vmtw.in

09-07-2017

## ORIENTATION PROGRAMME ON MENTOR MENTEE SYSTEM

The internal quality Assurance Cell of VMTW organized a Faculty Orientation Programme on Mentor Mentee System 09/07/2017 at 10:00am for all the Faculty Members.

**Speaker : Himagiri Danapana, Asst. Prof, JBIET, HYD**

**Venue: ASF-2 , A- BLOCK, VMTW**

Mr.P.Harikrishna, IQAC Co-ordinator gave the welcome address and presided over the gathering by briefing the purpose of the program on the Mentor-Mentee System between Faculty and Students to facilitate a structured mentorship program aimed at supporting students' academic and personal growth.



The Speaker started the session by giving Guidelines on mentoring system to be followed in the institution by explaining all the Objectives and importance of the programme.

This Orientation Program included the following key elements:

- Introduction to the Mentor-Mentee System
- Roles and Responsibilities of Mentors:
- Roles and Responsibilities of Mentees:
- Effective Communication and Feedback:
- Monitoring and Evaluation:



*[Handwritten Signature]*  
PRINCIPAL

Vignan's Institute of Management & Technology For Women  
Kondapur (V), Ghatkesar (M), Medchal-Malkajgiri (Dt),  
Telangana State



# VIGNAN'S INSTITUTE OF MANAGEMENT AND TECHNOLOGY FOR WOMEN

[Sponsored by Lavu Educational Society, Approved by AICTE, New Delhi & Affiliated to JNTUH, Hyderabad.]

Kondapur (V), Ghatkesar (M), Medchal - Malkajgiri (D) - 501 301 TS INDIA

Phone: +08415 200006/07/08

Email: info.vmtw.in



## Participation and Engagement:

Faculty members actively participated in the Orientation Program, showing enthusiasm and willingness to engage in the mentor-mentee relationship. Interactive sessions allowed for open discussions, sharing of experiences, and clarification of doubts, contributing to the establishment of a supportive mentorship culture.

In conclusion, the Orientation Program on the Mentor-Mentee System has set the stage for a dynamic and supportive mentorship culture at VMTW. We are confident that this initiative will positively impact the personal and academic development of our students, ultimately contributing to their success and the overall growth of our institution.

The Program is concluded by a formal Vote of thanks by IQAC, Co-ordinator.

*[Handwritten Signature]*  
PRINCIPAL

Vignan's Institute of Management & Technology For Women  
Kondapur (V), Ghatkesar (M), Medchal-Malkajgiri (D) - 501 301  
Telangana State

*[Handwritten Signature]*  
Co-ordinator, IQAC





# VIGNAN'S INSTITUTE OF MANAGEMENT AND TECHNOLOGY FOR WOMEN

(Approved by AICTE, New Delhi & Affiliated to JNTUH, Hyderabad.)

Kondapur (V), Ghatkesar (M), Medchal - Malkajgiri (D) - 501 301

## INTERNAL QUALITY ASSURANCE CELL (IQAC)

ORGANIZING

ORIENTATION PROGRAMME ON

# RESEARCH TOOLS

13<sup>TH</sup> JULY, 2018 @ 10 AM  
VENUE: ASF-2, A-BLOCK.



Resource Person:

**Dr. L. Sridhara Rao,**

Associate Professor & HOD,  
Department of IT,  
JBIET, Hyderabad.



*[Signature]*  
PRINCIPAL

Vignan's Institute of Management & Technology For Women  
Kondapur (V), Ghatkesar (M), Medchal-Malkajgiri (D) - 501 301  
Telangana State

Chief Patron:

**Dr. Lavu Rathaiah,**  
Chairman, Vignan Group.

Patron:

**Mr. B. Shravan,**  
CEO, Vignan Group.

Co-Patron:

**Dr. P. Sudhakara Rao,**  
Principal, VMTW.

Advisor:

**Mr. P. Harikrishna,**  
Co-Ordinator, IQAC.

Program Co-Ordinator:

**Mrs. V. Suzan Shalini,**  
Assistant Professor, BS&H.  
Cell: +91 96529 10002

Date : 11/07/2018

To  
The Principal  
VMTW,  
Kondapur ,Ghatkesar

Subject: Request for Permission to Conduct Orientation Program on Research Tools  
Dear Sir,

I would like to bring to your kind notice that ,IQAC of our institution is planning to organize an orientation Program on Research Tools. I am writing this to seek your permission to conduct this program at institution, VMTW. This program aims to provide valuable knowledge and skills to our faculty members regarding the effective utilization of the research tool in their academic pursuits. The orientation program will be organized on 13/07/2018.

We kindly request your permission to proceed with the organization of this orientation program on the research tools. We are confident that with your support, the program will be a success and will benefit the entire academic community at VMTW.

Thank you Sir

*Approved  
Principal*

Yours Faithfully



P.Harikrishna

Co-ordinator ,IQAC



*Vignani*  
PRINCIPAL  
Vignani's Institute of Management & Technology For Women  
Kondapur (V), Ghatkesar (M), Medchal-Malkajgiri (Dt)-501301  
Telangana State

**Dr. L. Sridhara Rao**  
**Associate Professor and Head, Department**  
**of Information Technology, J B I E T, HYD.**  
**MOBILE:9440428640**  
**Email: sridhararao.it@jbiet.edu.in**



Dr. L. Sridhara Rao, M. Tech, Ph. D is presently working as Associate Professor and Head, Department of Information Technology, J B I E T, Hyderabad. He received his Doctorate from Bharathiar University and he has more than 15 years of teaching experience in various premier engineering colleges of India with excellent expertise in Teaching, Designing and Developing Curriculum for various Computer Science Courses. He is an Academician, Author, Researcher and delivered expert, guest lectures in various conferences and FDPs



  
PRINCIPAL  
Vignani's Institute of Management & Technology For Women  
Kandapur (V), Ghatkesar (M), Medchal-Malkajgiri (Dt),  
Telangana State





Date:13/07/2018

## Report on Orientation Programme on Research Tools

**Speaker :** Dr. L. Sridhara Rao, Associate Professor and Head, Department of IT, J B I E T, HYD.

**Venue:** ASF-2, A-BLOCK

An Orientation programme on research tools was organised by IQAC at Vignan's Institute of Management and Technology for Women on 13/07/2018 at 10:00 AM.



This Orientation on Research Tools aimed to provide faculty with practical knowledge and skills related to various tools and resources available for conducting research effectively. This orientation covered a range of research tools, including software, databases, and online platforms that enhance productivity, data analysis, collaboration, and literature review. This report summarizes the key highlights and outcomes of the workshop.



PRINCIPAL

Vignan's Institute of Management & Technology For Women  
Kondapur (V), Ghatkesar (M), Medchal-Malkajgiri (D)-501301  
Telangana State



### Orientation Agenda:

- Introduction to Research Tools
- Reference Management Tools
- Data Analysis and Visualization Tools
- Collaboration and Communication Tools
- Literature Review Tools.

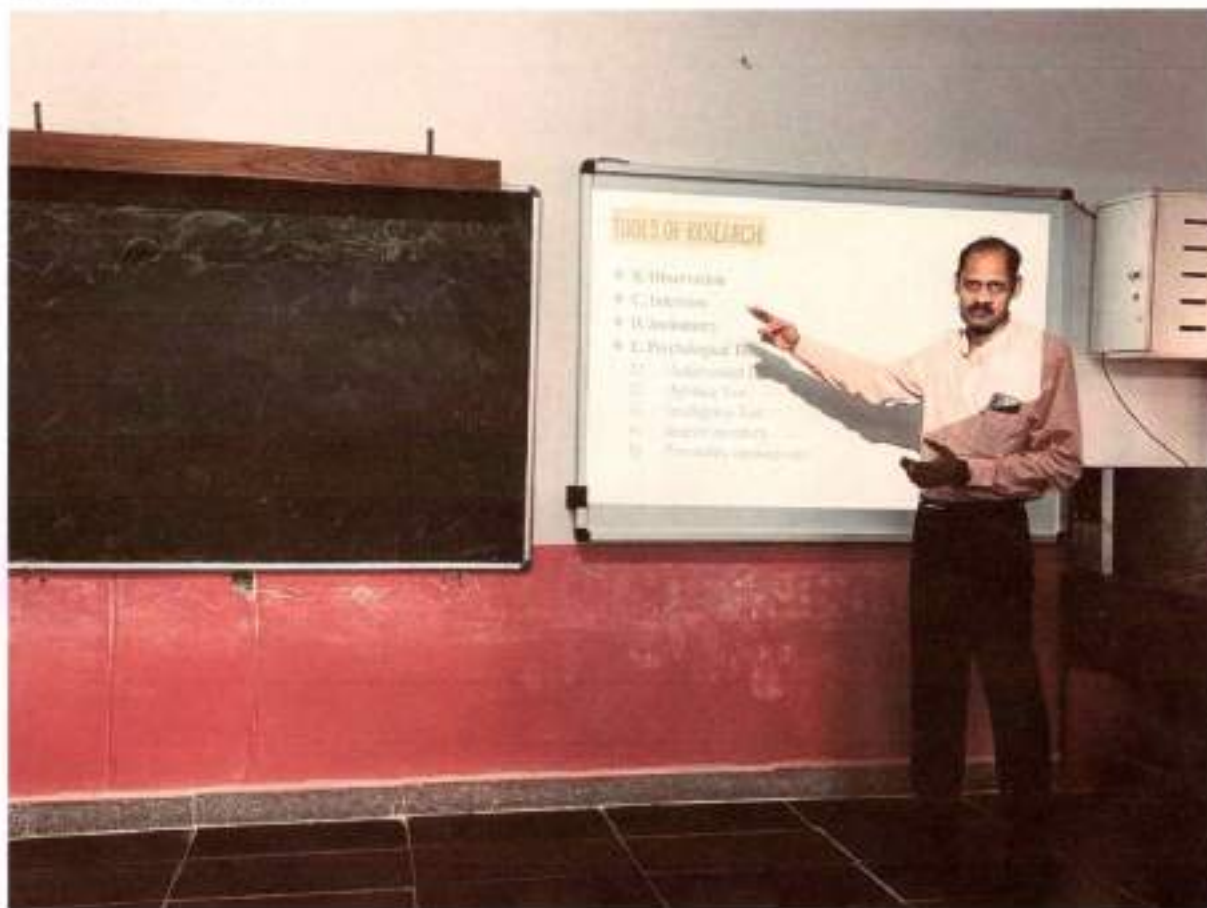

### Introduction to Research Tools:

This program began with an overview of the importance of research tools in the research process. Participants gained insights into how utilizing appropriate tools can streamline their work, save time, and improve the quality of their research.

### Reference Management Tools:



*ASH*  
PRINCIPAL

Vignans Institute of Management & Technology For Women  
Kondapur (V), Ghatkesar (M), Medchal-Malkajgiri (Dt)-501 301  
Telangana State



Speaker focused on popular reference management tools such as EndNote, Mendeley, and Zotero. Participants learned how to organize and manage references, generate citations and bibliographies, and collaborate on reference lists with other researchers.

**Data Analysis and Visualization Tools:**

In this segment, participants were introduced to statistical analysis software like SPSS, R, and Python. They learned how to import, clean, and analyze research data using these tools. Additionally, participants explored visualization tools like Tableau and Excel for effective data representation.

**Collaboration and Communication Tools:**

This session highlighted tools that facilitate collaboration and communication among researchers. Participants discovered the features of tools such as Google Docs, which enable real-time collaboration, file sharing, and effective communication within research teams.

**Literature Review Tools:**

It also included a session on literature review tools such as PubMed, Google Scholar, and Scopus. Participants learned advanced search techniques, citation tracking, and alerting features to stay updated with the latest research in their respective fields.

**Outcomes and Benefits:**

- Enhanced Research Productivity
- Improved Data Analysis and Visualization
- Efficient Collaboration and Communication
- Streamlined Literature Review Process

**Conclusion:**

A special word of thanks given by IQAC, Co-ordinator to the speaker Dr. L. Sridhara Rao, for his expertise, insights, and thought-provoking presentation have captivated the minds and broadened participants perspectives.

This Orientation program on research tools provided faculty with valuable insights and practical skills to leverage various tools for their research endeavours. By incorporating these tools into their workflows, researchers can optimize their research process, enhance productivity, and produce high-quality research outputs.



CO-ORDINATOR, IQAC

PRINCIPAL

Vignan's Institute of Management & Technology For Women  
Kondapur (V), Ghatkesar (M), Medchal-Malkajgiri (D),  
Telangana State



## VIGNAN'S INSTITUTE OF MANAGEMENT AND TECHNOLOGY FOR WOMEN

(Sponsored by Lavu Educational Society)  
Approved by AICTE, New Delhi & Affiliated to JNTUH, Hyderabad.  
Kondapur (V), Ghatkesar (M), Medchal - Malkajgiri (D) - 501 301



### INTERNAL QUALITY ASSURANCE CELL (IQAC)

ORGANIZING

ORIENTATION PROGRAM ON

# EFFECTIVE IMPLEMENTATION OF OUTCOME BASED EDUCATION

31<sup>ST</sup> AUGUST, 2020 @ 11 AM

VENUE: SEMINAR HALL



Resource Person:  
**Dr. Ch. Srinivasulu,**  
Professor, CSE,  
IARE, Hyderabad.

Chief Patron:  
**Dr. Lavu Rathalah,**  
Chairman, Vignan Group.

Patron:  
**Mr. B. Shrevan,**  
CEO, Vignan Group.

Co-Patron:  
**Dr. G. Apparao Naidu,**  
Principal, VMTW.

Advisor:  
**Mr. P. Harikrishna,**  
Co-Ordinator, IQAC.

Program Co-Ordinator:  
**Mr. K. Bharath Reddy,**  
Assistant Professor,  
Department of CSE.  
Cell: +91 96529 10002



*Asa*  
PRINCIPAL  
Vignan's Institute of Management & Technology For Women  
Kondapur (V), Ghatkesar (M), Medchal-Malkajgiri (D),-501301  
Telangana State

28/08/2020

To

The Principal

VMTW,GHATKESAR.

Sub: Request to Conduct Orientation Program on Effective Implementation of Outcome-Based Education Req-Reg:

Respected Sir,

I am writing to formally request your permission and support to organize an orientation program on Effective Implementation of Outcome-Based Education (OBE) for the faculty and staff of our institution. This program aims to familiarize the entire team with the concepts, benefits, and implementation strategies of OBE.

I kindly request your permission to allocate a suitable date and time for the orientation program, allowing all teachers and staff members to attend without any disruption to their regular duties.

Thank you for your attention to this matter.

Yours Sincerely



P. Harikrishna

IQAC Co-ordinator

*Approved*  
*2-1-2020*  
*28/8*  
*Conduct on 31/08/20*



*[Handwritten Signature]*  
**PRINCIPAL**  
Vignans Institute of Management & Technology For Women  
Kondapur (V), Ghatkesar (M), Medchal-Malkajgiri (Dt.)-501301  
Telangana State

**Dr. Ch.Srinivasulu**  
**Professor in CSE,IARE**  
**Mobile: +91 9052441559**  
**Email:ch.srinivasulu@iare.ac.in**



Dr.Ch.Srinivasulu has done his B.Tech from Sri Venkateshwara University,Tirupathi,M.Tech Computer Science Engineering from JNTUH,and Obtained his Ph.D from JNTU KAKINADA.

**PATENTS:**

1. REAL TIME CROP MONITORING USING INTERNET OF THINGS IOT BASED PRECISION AGRICULTURE.
2. IBDD CROP HEALTH IOT BASED DEVICE TO DETECT THE CROP HEALTH

**PUBLICATIONS:**

1. House Price Prediction Using Machine Learning

Dr.G.Naga Satish, Dr.Ch.V.Raghavendran

International Journal of Innovative Technology and Exploring Technology , Volume 8, Year 2019, Pages 717-722.

2. A Framework For Conversion Of Serial Programming Paradigm Into Parallel Using Architecture Independent Factors

Dr Ch.Srinivasulu

International Journal of Latest Trends in Engineering and Technology, Year 2017

- 3.A NOVEL AUTOMATIC C TO NVIDIACUDA CODE OPTIMIZATION FRAMEWORK.

Srinivasulu, Chennupalli and Upadhyay, Niraj and Govardhan, A

International Journal of Advanced Research in Computer Science, Volume 8, Year 2017

- 4.An Adjacent Analysis of the Parallel Programming Model Perspective: A Survey

Srinivasulu, Chennupalli and Upadhyaya, Niraj and Govardhan, A

, Year 2017

- 5.Feature Relation Networks for Sentiment Detection in Messages

Hemalatha, I and Varma, GPS and Govardhan A

International Journal of Research in Science & Advanced Technologies, Year 2014



  
**PRINCIPAL**  
Vignan's Institute of Management & Technology For Women  
Kondapur (V), Ghatkesar (M), Medchal-Malkajgiri (Dt.)-501301  
Telangana State

6. An efficient resource allocation technique for uniprocessor system

Devi, Botlagunta Madhavi and Agrawal, Smriti and Srinivasulu, Chennupalli

International Journal of Advances in Engineering & Technology, Volume 6, Year 2013, Pages 35

7.A Total Need Based Resource Reservation Technique For Effective Resource Management

Ch.Srinivasulu

International Journal of Computer Applications, Volume 67, Year 2013

8.Security enhancement in WEP mobility

Abbas Ahmad, S. M.K.M.;Rajan, E. G.;Govardhan, A.;Peraiah, Juluru

Communications in Computer and Information Science, Volume 90  
CCIS, Year 2010, Pages 388-399

9.Hybrid Model for Software Development Life Cycle

Munassar, Nabil Mohammed and Govardhan, A

Journal of Science and Technology, Volume 15, Year 2010

10.Self-Monitored Security for WEP Protocol in Wireless Ad Hoc Network

Ahmad, SMKM Abbas and Rajan, EG and Govardhan, A

11.Computer Vision and Information Technology: Advances and Applications, Year 2010, Pages 479

12.Hierarchical Image Compression with Clustered Image Representation in Natural Images

Satyanarayana, B and Govardhan, A and Murthy, HSN

13.Advances in Computational Sciences and Technology, Volume 3, Year 2010, Pages 127—135

14.Reversible watermarking mechanisms-a new paradigm in image security

Rao, T Venkat Narayana and Govardhan, A

Indian Journal of Science and Technology, Volume 2, Year 2009, Pages 23--28

15.Enhanced aperiodic responsiveness by preemption control

Vijay R.;Yadav R.S.;Agrawal S.

ACT 2009 - International Conference on Advances in Computing, Control and Telecommunication Technologies, Year 2009, Pages 351-355

16.Effect of various covering methods on nitrogen loss during urea ammoniation of paddy straw.

Srinivasulu, C and Prabhu, MRL and Reddy, KS and others

JNKVV Research Journal, Volume 34, Year 2000, Pages 34—37



  
PRINCIPAL  
Vignan's Institute of Management & Technology For Women  
Kondapur (V), Ghatkesar (M), Medchal-Malkajgiri (Dt.)-501301  
Telangana State



Date: 31/08/2020

**Orientation Programme on Effective implementation of Outcome Based Education**

**Speaker: Dr.Ch.Srinivasulu. Professor CSE,IARE,HYD**

**Venue: Seminar Hall**

**Time: 11:00 am**

This program aimed to equip participants with the knowledge, skills, and strategies necessary for successful implementation of OBE in educational institutions.



It provides an overview and evaluation of an Orientation Programme focused on the effective implementation of Outcome-Based Education (OBE). The programme aimed to orient faculty members and administrators, to the principles and strategies of OBE and provide them with the necessary knowledge and skills to implement it successfully in educational institution.



PRINCIPAL

Vignan's Institute of Management & Technology For Women,  
Kondapur (V), Ghatkesar (M), Medchal-Malkajgiri (D),  
Telangana State





The programme aimed to familiarize participants with the principles, concepts, and benefits of Outcome-Based Education and highlight its relevance to contemporary educational practices. Participants were expected to develop a clear understanding of the key components of OBE, including defining measurable learning outcomes, aligning assessments and teaching strategies with outcomes, and utilizing effective evaluation methods.

Speaker also explained briefly about the required knowledge and skills necessary to design and align curriculum components, ensuring that they support the achievement of desired learning outcomes.



Participants were encouraged to engage in collaborative discussions and activities, promoting the exchange of ideas, sharing of best practices, and building a supportive network for ongoing implementation of OBE. Programme aimed to offer guidance and resources to participants, enabling them to develop action plans and implement OBE effectively within their educational context.

Participants received an overview of the principles and rationale behind OBE, including the shift from content-driven to competency-based education.

Speaker also focused on helping participants develop the skills to define clear, measurable, and observable learning outcomes that align with institutional goals and student needs.



  
**PRINCIPAL**  
Vignan's Institute of Management & Technology For Women  
Kondapur (V), Ghatkesar (M), Medchal-Malkajgiri (D) - 501301  
Telangana State



Participants engaged in workshops and discussions to understand how to design curriculum components, such as courses and modules, that align with the defined learning outcomes. He explored various assessment strategies and techniques to ensure that assessments align with learning outcomes and provide meaningful feedback on student achievement. Participants were introduced to student-centered teaching and learning approaches that promote active engagement, critical thinking, and the development of key competencies and skills.

### Program Outcomes

- **Increased Understanding of OBE:** Participants demonstrated an improved understanding of the principles, concepts, and benefits of OBE, recognizing its potential for enhancing student learning and educational quality.
- **Enhanced Curriculum Design and Alignment Skills:** Participants developed the skills to design curriculum components that align with defined learning outcomes, ensuring coherence and alignment throughout the educational system.
- **Improved Assessment and Evaluation Practices:** Participants acquired the ability to develop assessments that effectively measure student achievement of learning outcomes and utilize appropriate evaluation methods.
- **Adoption of Student-Centered Approaches:** Participants embraced student-centered teaching and learning approaches, integrating active learning strategies and promoting student engagement and critical thinking.
- **Collaboration and Best Practice Sharing:** The orientation programme fostered collaboration and networking among participants, creating a supportive community for ongoing sharing of best practices and collective problem-solving.
- **Action Plans for OBE Implementation:** Participants developed action plans to implement OBE within their educational context, setting clear goals, timelines, and strategies for successful implementation.



**PRINCIPAL**

Vignan's Institute of Management & Technology for Women  
Kondapur (V), Ghatkesar (M), Medchal - Malkajgiri (D)  
Telangana State



## VIGNAN'S INSTITUTE OF MANAGEMENT AND TECHNOLOGY FOR WOMEN

(Sponsored by Lavu Educational Society)  
Approved by AICTE, New Delhi & Affiliated to JNTUH, Hyderabad.  
Kondapur (V), Ghatkesar (M), Medchal - Malkajgiri (D) - 501 301



### INTERNAL QUALITY ASSURANCE CELL (IQAC)

ORIENTATION PROGRAM ON

# CREATING A CULTURE OF CONTINUOUS QUALITY IMPROVEMENT

2<sup>ND</sup> SEPTEMBER, 2021 @ 11 AM  
VENUE: SEMINAR HALL



Resource Person:  
**Dr. Vijaya Pal Reddy,**  
Professor, CSE,  
Matrusri Engineering College,  
Hyderabad.

Chief Patron:  
**Dr. Lavu Rathaiah,**  
Chairman, Vignan Group.

Patron:  
**Mr. B. Shraavan,**  
CEO, Vignan Group.

Co-Patron:  
**Dr. G. Apparao Naidu,**  
Principal, VMTW.

Advisor:  
**Mr. G. Rajesh,**  
Co-Ordinator, IQAC.

Program Co-Ordinator:  
**Mrs. V. Suzan Shalini,**  
Assistant Professor, BS&H.  
Cell: +91 96529 10002



*VASH*  
PRINCIPAL  
Vignan's Institute of Management & Technology For Women  
Kondapur (V), Ghatkesar (M), Medchal-Malkajgiri (DL)-501301  
Telangana State

Date:30/08/2021

To  
The Principal,  
VMTW,  
Kondapur,  
Ghatkesar

Subject:Approval to Conduct Orientation Programme on Quality improvement Req-Reg:-

Respected Sir,

On behalf of the Internal Quality Assurance Cell (IQAC) of our institution, I am writing to request your support and approval for organizing Orientation Programme on "Creating a Culture of Continuous Quality Improvement" on 02/09/21.

Thank you for considering our request. We look forward to your favourable response.

Yours Faithfully

  
G. Rajesh

IQAC-Co-ordinator



  
PRINCIPAL  
Vignans Institute of Management & Technology For Women  
Kondapur (V), Ghatkesar (M), Medchal-Malkajgiri (Dt.)-501301  
Telangana State

**Dr. P. Vijaya Pal Reddy**  
**Professor & Head of Department**  
**Qualification: M.Tech, Ph.D**  
**Specialization: Computer Science and**  
**Engineering**  
**Email: p.vijayapalreddy@matrusri.edu.in**



#### Research Interests

- Natural Language Processing
- Text Mining, Data Mining
- Optical Character Recognition

**Experience in years** :18

**Seminars Presented:** 7

**Seminars or W/S Attended:** 13

**Professional body** :CSI, ISTE, FSMI, SDIWC, IAENG

**W/s or Seminars Organized:** 8

**Orientation /Refresher programs (Presented/attended)** :18

#### Publications

1. A survey on authorship profiling techniques  
TR Reddy, BV Vardhan, PV Reddy  
International Journal of Applied Engineering Research 11 (5), 3092-3102
2. Influence of lexical, syntactic and structural features and their combination on authorship attribution for Telugu text  
SN Prasad, VB Narsimha, PV Reddy, AV Babu  
Procedia Computer Science 48, 58-64
3. Profile specific document weighted approach using a new term weighting measure for author profiling  
TR Reddy, BV Vardhan, PV Reddy  
International Journal of Intelligent Engineering and Systems 9 (4), 136-146
4. An unusual case of cholecystitis  
M Reddy, PV Reddy  
The American journal of the medical sciences 326 (2), 105-106



  
**PRINCIPAL**  
Vignan's Institute of Management & Technology For Women  
Kondapur (V), Ghatkesar (M), Medchal-Malkajgiri (Dt.)-501301  
Telangana State

5. N-gram approach for gender prediction  
TR Reddy, BV Vardhan, PV Reddy  
2017 IEEE 7th International Advance Computing Conference (IACC), 860-865
6. Author profile prediction using pivoted unique term normalization  
TR Reddy, BV Vardhan, PV Reddy  
Indian Journal of Science and Technology 9 (46)
7. A document weighted approach for gender and age prediction  
T Raghunadha Reddy, B Vishnu Vardhan, P Vijayapal Reddy  
Int J Eng-Trans B: Appl 30 (5), 647-653
8. Authorship attribution based on data compression for telugu text  
S Nagaprasad, PV Reddy, AV Babu  
International Journal of Computer Applications 110 (1), 1-5
9. Corpus based extractive document summarization for Indic script  
PV Reddy, BV Vardhan, A Govardhan  
2011 International Conference on Asian Language Processing, 154-157
10. Empirical evaluations using character and word n-grams on authorship attribution for Telugu text  
S Nagaprasad, T Raghunadha Reddy, P Vijayapal Reddy, A Vinaya Babu, .
11. Learning Approaches toward Title Word Selection on Indic Script  
PV Reddy, A Govardhan  
International Journal on Computer Science and Engineering 3 (3)
12. Analysis of BMW model for title word selection on indic script  
PV Reddy, BV Vardhan, A Goverdhan  
International Journal of Computer applications 18 (8), 1-5



  
PRINCIPAL  
Vignans Institute of Management & Technology For Women  
Kondapur (V), Ghatkesar (M), Medchal-Malkajgiri (Dt.)-501301  
Telangana State



The primary objectives of the orientation program were as follows:

- To create awareness about the importance of continuous quality improvement in higher education institutions.
- To familiarize faculty with the key principles and concepts of continuous quality improvement.
- To equip faculty with the necessary knowledge and tools to actively contribute to the quality improvement processes.
- To encourage a collaborative approach towards identifying areas for improvement and implementing effective strategies.
- To foster a culture of self-reflection, evaluation, and innovation for continuous growth and development.

The program began with an introduction to the concept of continuous quality improvement, emphasizing its significance in enhancing educational outcomes and institutional effectiveness.

Faculty were provided with examples and case studies of successful quality improvement initiatives implemented in other institutions.

The orientation program focused on providing faculty with an understanding of quality assurance systems and their role in fostering continuous improvement.

The key components of quality assurance, such as setting benchmarks, data collection, analysis, and feedback mechanisms, were discussed in detail.



  
PRINCIPAL  
Vignan's Institute of Management & Technology For Women  
Kondapur (V), Ghatkesar (M), Medchal-Malkajgiri (Dt.)-501301  
Telangana State



Date :2<sup>nd</sup> September 2021

## Report on "Orientation Programme on Creating a Culture of Continuous Quality Improvement"

**Speaker:** Dr.P.Vijaya Pal Reddy,Professor and HOD,CSE,Matrusri Engineering College.

**Venue:** Seminar Hall, VMTW

**Time :**11:00 am

Program commenced with inaugural session by Dr.G.Apparao Naidu, Principal ,VMTW.

Dr. G Apparao Naidu sir delivered an engaging and inspiring opening address. The address focused on the significance of creating a culture of continuous quality improvement in educational institutions and its impact on student learning outcomes, institutional effectiveness, and overall excellence. He also emphasized the role of every participant in driving this culture and encouraged active engagement and collaboration throughout the program.

After the inaugural session IQAC,Co-ordinator welcomed the speaker to start his session on today's topic. Speaker of the day Dr. P.Vijaya Pal Reddy, ,Professor and HOD,CSE,Matrusri Engineering College started the session by explaining the steps to promote a culture of continuous improvement among faculty, students, and other stakeholders, with the aim of enhancing the overall quality of institution.



*[Handwritten Signature]*  
**PRINCIPAL**  
Vignans Institute of Management & Technology For Women  
Kondapur (V), Ghatkesar (M), Medchal-Malkajgiri (D).-501301  
Telangana State





### **Tools and Techniques for Continuous Quality Improvement:**

Faculty were introduced to various tools and techniques commonly used in continuous quality improvement, such as SWOT analysis, PDCA (Plan-Do-Check-Act) cycle, and root cause analysis.

Practical exercises and group discussions were conducted to enable faculty to apply these tools and techniques to real-life scenarios.

The orientation program emphasized the importance of developing and implementing effective quality improvement strategies.

Faculty were provided with guidance on developing action plans, setting measurable goals, and monitoring progress towards achieving quality improvement objectives.

### **Promoting a Culture of Collaboration and Innovation:**

The program emphasized the need for collaboration and shared responsibility in fostering a culture of continuous improvement.

Faculty were encouraged to actively engage in cross-functional teams, share best practices, and explore innovative approaches to address quality improvement challenges.

Towards the end of the program, faculty were given the opportunity to reflect on their learnings and develop personal action plans to contribute to continuous quality improvement in their respective roles.

### **Conclusion:**

A Quality Initiative Orientation Program conducted by IQAC was highly successful in promoting a culture of continuous improvement among the faculty. The program provided valuable insights, tools, and techniques to actively contribute to quality improvement initiatives in our institution. It fostered a sense of collaboration, innovation, and shared responsibility for enhancing the overall quality of education.

Program concluded with the vote of thanks by IQAC Co-ordinator extending his gratitude to the IQAC team, resource person, and the entire faculty for their active involvement and valuable contributions throughout the orientation program. Their enthusiasm and commitment to continuous quality improvement will undoubtedly have a positive impact on our institution's growth and development.

  
IQAC CO-ORDINATOR



  
**PRINCIPAL**  
Vignan's Institute of Management & Technology For Women  
Kondapur (V), Ghatkesar (M), Medchal-Malkajgiri (D),-501301  
T.S.



# VIGNAN'S INSTITUTE OF MANAGEMENT AND TECHNOLOGY FOR WOMEN

(Approved by AICTE, New Delhi & Affiliated to JNTUH, Hyderabad.)

Kondapur (V), Ghatkesar (M), Medchal - Malkajgiri (D) - 501 301

## INTERNAL QUALITY ASSURANCE CELL (IQAC)

ORGANIZING

ONE-DAY WORKSHOP ON

# OUTCOME BASED EDUCATION

18<sup>TH</sup> MAY, 2019 @ 10 AM

AT SEMINAR HALL



Resource Person:

**Mr. Kavuri Roshan,**

Associate Professor & HOD, ECM,  
JBIET, Hyderabad.

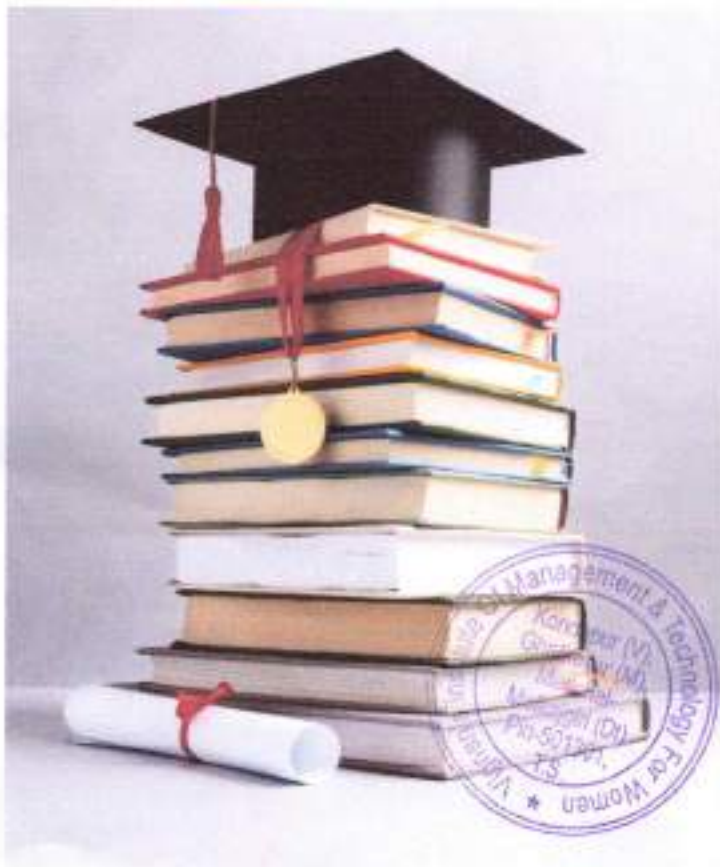

Chief Patron:

**Dr. Lavu Rathaiah,**  
Chairman, Vignan Group.

Patron:

**Mr. B. Shraavan,**  
CEO, Vignan Group.

Co-Patron:

**Dr. P. Sudhakara Rao,**  
Principal, VMTW.

Advisor:

**Mr. P. Harikrishna,**  
Co-Ordinator, IQAC

Program Co-Ordinator:

**Mr. J. Sunil Kumar,**  
Assistant Professor, ECE.  
Cell: +91 83747 17668

*Handwritten signature*  
**PRINCIPAL**  
Vignans Institute of Management & Technology For Women  
Ghatkesar (M), Medchal - Malkajgiri - 501301  
Telangana State

Date:15/05/2019

To  
The Principal,  
VMTW,  
Kondapur, Ghatkesar

Subject: Request for Approval to organise a One Day Workshop on "Outcome Based Education"

Respected Sir,

As a Co-ordinator of the Internal Quality Assurance Cell (IQAC) at our institution, I am writing to seek your approval for organizing a workshop on "Outcome Based Education" on 18<sup>th</sup> May. I kindly request your approval for organizing this seminar, as it aligns with the institution's commitment to excellence in education and the continuous professional development of our faculty and staff. We believe that this seminar will contribute to the overall growth and development of our institution and its stakeholders.

I look forward to your positive response and the opportunity to organize this Workshop on "Outcome Based Education"

Thank you sir.

Yours Faithfully

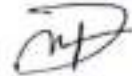

P. Harikrishna  
Co-Ordinator, IQAC

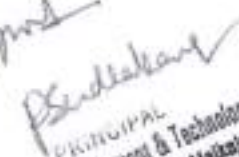
  
  
PRINCIPAL  
Vignn's Institute of Management & Technology For Women  
Kondapur(V), Ghatkesar(M), Medchal-Malkajgiri(DT)-501301  
Telangana State  
PRINCIPAL  
Vignn's Institute of Management & Technology For Women  
Kondapur(V), Ghatkesar(M), Medchal-Malkajgiri(DT)-501301  
Telangana State

**Mr.KAVURI ROSHAN**

H No.: 5-101/3B  
Shanti Nagar Colony  
Hydershakote,  
Gandipet (Mandal)  
Hyderabad  
India-500091



Mail ID: [roshan.kavuri@gmail.com](mailto:roshan.kavuri@gmail.com)  
Ph. No.: +91- 9949106818

**Career Objective:**

- To work in a challenging atmosphere by exhibiting my skills, knowledge and experience with utmost sincerity and dedication for the growth of your Esteemed Organization along with mine.

**Educational Profile:**

- M. Tech.- Computer Science & Engineering (CSE) from Jawaharlal Nehru Technological University Hyderabad (JNTUH), Kukatpally, Hyderabad (2001-2003)
- B.E.- Electronics & Communication Engineering (ECE) from S.R.K.R ENGINEERING COLLEGE, Bhimavaram (West Godavari District),Andhra Pradesh, Andhra University, (1988-1992)

**Memberships in Professional bodies:**

- Life Member in Computer Society of India (MCSI)
- BOS chairman for ECM department, JBIET from June 2014 to till date
- Academic council member JBIET from June 2014 to till date

**Administrative Skill set:**

- Well versed with all sorts of administrative works in Engineering & Technology such as accreditation AICTE, NAAC & NBA, College Autonomous, reports.



*Vignana*  
**PRINCIPAL**  
Vignana's Institute of Management & Technology For Women  
Kondapur(V), Ghatkesar(M), Medchal-Malkajgiri (Dist),  
Telangana State

### **Experience:**

- Working as an **Associate Professor&HoD in Electronics and Computer Engineering (ECM) Department**, J.B INSTITUTE OF ENGINEERING & TECHNOLOGY, Yenkapalli, Moinabad, Hyderabad from June, 2014 to till date.
- Worked as an **Additional Controller of Examinations** for the UG Courses from Oct.2013 to March, 2017 in J.B INSTITUTE OF ENGINEERING & TECHNOLOGY, Yenkapalli, Moinabad, Hyderabad.
- Worked as an Associate Professor in Information Technology Department, J.B INSTITUTE OF ENGINEERING & TECHNOLOGY, Yenkapalli, Moinabad, Hyderabad (from July,2009 to May,2014).
- Ratified as an Associate Professor in IT Department in 2011, J.B INSTITUTE OF ENGINEERING & TECHNOLOGY, Yenkapalli, Moinabad, Hyderabad.
- Worked as a coordinator of **Jawaharlal Knowledge Centre (JKC) from 2010-2013**, J.B INSTITUTE OF ENGINEERING & TECHNOLOGY, Yenkapalli, Moinabad, Hyderabad.
- Worked as a **HoD-MCA & I/C HOD-IT Depts.**, J.B INSTITUTE OF ENGINEERING & TECHNOLOGY, Yenkapalli, Moinabad, and Hyderabad. (2007-2009)
- **Ratified as an Assistant Professor in IT Department in 2006** J.B INSTITUTE OF ENGINEERING & TECHNOLOGY, Yenkapalli, Moinabad, Hyderabad
- **Coordinated NBA** work from IT Department. J.B INSTITUTE OF ENGINEERING & TECHNOLOGY, Yenkapalli, Moinabad, Hyderabad
- Worked as an Assistant Professor in CSE Department at J.B INSTITUTE OF ENGINEERING & TECHNOLOGY, Yenkapalli, Moinabad, Hyderabad (2004-2006)
- Worked as an Assistant Professor in CSE Dept., Dr. V.R. K COLLEGE OF ENGINEERING & TECH, Jagitial, Karimnagar (Dist.) from June, 2003 to July, 2004.
- Worked as a **Maintenance Engineer** in Ultra-Batteries, Jeedimetla, Hyderabad (1997-2001)
- Worked as Lecturer in Govt. Junior College in Rangasaipet, Warangal in **Radio & Television Vocational Course** at Intermediate Level. (June,1994 - April,1997)
- Worked as an **Apprentice Telecom Trainee Engineer** in 132 KV /Sub Station, Guntur (1993-1994)



*ASH*  
PRINCIPAL  
Vignana's Institute of Management & Technology For Women  
Kondapur(V), Ghatkesar(M), Medchal-Malkajgiri(Dt)  
Telangana State

**Papers presented**

S. No	NAME OF THE JOURNAL/ CONFERENCE/ WORKSHOP	TITLE OF THE PAPER	VENUE/ DATE
1.	International Journal of Scientific Research and Review	Efficient Cache Supported Path Planning on Roads	Volume 7, Issue 6, 2018
2.	Published paper in IJRCSE Vol- 4 (International Journal of Research in Computer Science Engineering)	Secure Delegating Logging as a Service Management to Cloud	Sep.- Oct., 2014
3.	Published paper in National Conference on Advanced Computing and Pattern Recognition-2014	Enhanced Multi-Tier Security for Wireless Sensor Networks	March, 2014
4.	Paper published in IJRRECS (International Journal of Reviews on Recent Electronics and Computer Science	Proficient Topology for reducing Data loss in wireless networks	October, 2013
5.	Paper published in GJCST Global journal of Computer Science and Technology Graphics & Vision	Robust Automatic Face recognition	May, 2013
6.	Proceedings of the second International Conference on Computational Science, Engineering and Informational Technology (CCSEIT-2012)	Fault Tolerance: Case Study	ACM Digital Library October, 2012
7.	International Journal of Computer Science & Information Technology(IJCSIT)	Newfangled Method against Data Flooding Attacks in NANET	June, 2012
8.	International Conference of Advanced Computer Science & Information Technology (ACSIT_2012)	Panoramio- A Mobile application Based on Android	Chennai July,2012
9.	International Workshop of Information Technology, Control and Automation(ITCA 2012)	Online Subversion Web Client	Chennai, July,2012
10.	International conference of Advanced Computer Science & Information Technology (ACSIT_2012)	SQL Server Failover Clustering	Chennai, July, 2012
12.	International Journal of Computer Science & Informatics(IJCSI)	Image Edge Detection	Jan., 2012
13.	2 <sup>nd</sup> Vagdevi international conference on "Informational Technology for Real World Problems" in 2010 (Vcon-2010)	A paper on "Formal Modeling of Dynamic Mobile Device Grid	Warangal, Dec., 2010



  
 PRINCIPAL  
 Vignana's Institute of Management & Technology For Women  
 Kondapur(V), Ghatkesar(M), Medchal-Malkajgiri(Dt)-501301  
 Telangana State

### Workshops & FDP's Attended /Delivered lectures

1. Delivered a Guest Lecture in "**Induction program for newly joined Faculty**" from 19<sup>th</sup> - 20<sup>th</sup> December 2017 organized by JBIET
2. Attended one week national level workshop on "**MATLAB and its Applications**" MIA17 during 1<sup>st</sup> May 2017 to 6<sup>th</sup> May 2017.
3. Attended a FDP program on "**Significance of Outcome Based Education (OBE) in achieving excellence**" organized by JBIET during 21-22 April 2017
4. Delivered a Lecture in Faculty development program on "**Effective teaching Methodologies & Best practices**" from 22-28<sup>th</sup> February 2017 organized by JBIET
5. Attended a faculty Development Programme on "**IOT**" from 9<sup>th</sup>-14<sup>th</sup> October 2017, organized by department of CSE, JBREC.
6. Attended a faculty Development Programme on "**Statistical Analysis with R**" from 18<sup>th</sup>-23<sup>rd</sup> March 2017, department of CSE, JBIET
7. Participated in One-Week Faculty Development Program on "**Effective Teaching Methods & Best Practices**" in JBIET during 5 – 9 December, 2016.
8. Participated in "**Elsevier Connect Seminar**" held on 16 November, 2016, Hyderabad.
9. Participated in a one-day workshop on "**Research Trends in VLSI & Embedded Systems**" on 5 November, 2016 in JNTUHCE, Hyderabad.
10. ECM branch organized fest "**Progrezion**" on 31st March & 1st April, 2K16 Chief Guest Dr.P.K.Jain Scientist-F & Team leader ARCI, HYDERABAD
11. Attended a FDP program on "**Microsoft Azure**" on 14<sup>th</sup> & 15<sup>th</sup> March 2016
12. One Day workshop conducted by ECM dept. with **Mozilla Firefox team** on 20th Feb 2016 at MIC JBIET by Akshay, Santosh, Harsha Vardhan & Deepak Upendra.
13. Organized A Guest Lecture on October 8th 2015 by Chief Guest Dr. A. Govardhan (Director SIT & EC Member, JNTU-H) on "**Recent Trends of learning to become a good Software Professional**"
14. Two-day National Level Workshop on "**Research Methodology in Science, Engineering & Management**" held during 28<sup>th</sup> February 2014 & 1<sup>st</sup> March 2014 at JBIET, Hyderabad, Andhra Pradesh
15. Co-ordinted for "**3D GAME Designing & Scripting**" by Virscent Technologies Pvt. Ltd.(An IIT Kharagpur Alumni Venture) in association with Education Project Council of India from 19<sup>th</sup>-20<sup>th</sup> March, 2013 at JBIET.
16. Participated in 'Mission 10X' workshop conducted at J. B. Institute of Engineering & Technology at Yenkapally (v), Moinabad (M), Ranga Reddy (Dist.) from 6<sup>th</sup> to 10<sup>th</sup> June



  
PRINCIPAL  
Vignans Institute of Management & Technology Pvt. Ltd.  
Kondapur(V), Ghuddepur(M), Medchal-Malgajpet(D), T.S. 501301  
Telangana State

17. 9. Attended a five days training program conducted by Mission 10X and Wipro from June 5<sup>th</sup> to June 9<sup>th</sup> 2011 at J. B. Institute of Engineering & Technology, Hyderabad.
18. 10. Attended one-day workshop on "Advanced Computer Architectures" on 28<sup>th</sup> March 2009 at JNTUCE Hyderabad, conducted in coordination with IIT Madras.
19. 11. Attended one-day workshop on "Systems Integration "by Microsoft and IEG/JKC through Mana TV on 20<sup>th</sup> Feb-2009.
20. 12. Attended a five-day workshop of "TECS" TCS Excellence in computer science 2008 by TCS Hyderabad. 14<sup>th</sup> to 18<sup>th</sup> Feb, 2008.
21. 13. Attended a Five-Day Workshop on "LINUX in Higher Technical Education during 3<sup>rd</sup> to 7<sup>th</sup> September 2007 at JBIET, Yenkapally, Hyderabad.
22. 14. Attended a three-day workshop on "Research Methodologies for Engineers" during 13<sup>th</sup> to 15<sup>th</sup> Feb-2007 at JBIET, Yenkapally, Hyderabad.

**Subjects Taught:**

S. No.	COURSE	SUBJECT NAME
1	UG	C&DS
		COMPUTER ORGANIZATION
		OPERATING SYSTEMS
		NETWORK SECURITY
		OSSP
		ADVANCED COMPUTER ARCHITECTURE
		INTRODUCTION TO NEURAL NETWORKS
		OOPS
		COMPUTER NETWORKS
2	UG	DISTRIBUTED OPERATING SYSTEMS
		DATA COMMUNICATIONS
		ARTIFICIAL NEURAL NETWORKS
		COMPUTER COMMUNICATIONS
		SOFTWARE ENGINEERING
		OOAD
		HUMAN COMPUTER INTERACTION
		SWITCHING THEORY & LOGIC DESIGN
		TELEMATICS,
3	PG	OPERATING SYSTEMS
		ADVANCED COMPUTER ARCHITECTURE
		COMPUTER NETWORKS
		NETWORK SECURITY
		ARTIFICIAL NEURAL NETWORKS
		SOFTWARE ENGINEERING
		DISTRIBUTED OPERATING SYSTEMS
PARALLEL COMPUTING		



**PRINCIPAL**  
 Vignans Institute of Management & Technology  
 Kondapur(V), Ghatkesar(M), Madhura-Mulajigga(D)-501501  
 Telangana State



**Personal Profile:**

Name : KAVURI ROSHAN  
Date of Birth : April 24, 1969  
Marital Status : Married  
Languages known : English, Hindi and Telugu (speak, read & write)

**Strengths**

Sincere, dedicated and hard working.



(Dr.KAVURI ROSHAN)



  
PRINCIPAL  
Vinaya's Institute of Management & Technology For Women  
Kondapur(V),Ghatkesar(M),Medchal-Malkajgiri(Dt)-501301  
Telangana State



# VIGNAN'S INSTITUTE OF MANAGEMENT AND TECHNOLOGY FOR WOMEN

[Sponsored by Lavu Educational Society, Approved by AICTE, New Delhi & Affiliated to JNTU(H, Hyderabad.)]

Kondapur (V), Ghatkesar (M), Medchal - Malkajgiri (D) - 501 301 TS INDIA

Phone: +08415 200006/07/08

Email: info.vmtw.in

Date:18/05/2019

## Report on One Day Workshop on Outcome based Education

IQAC of VMTW conducted One Day Workshop on Outcome based Education on 18/05/2019. A total of 47 faculty participated in Workshop which covered various key aspects of OBE & NBA,

Workshop sessions consists of

- Vision, Mission & Outcome Based Education ,
- Implementation of OBE, Mapping & Attainment of COs and POs,
- Mapping & Attainment of COs and Pos,
- OBE based Teaching Learning
- Continuous Improvement based on PO/PSO Attainment

Mr.Harikrishna Co-ordinator,IQAC extended his warm welcome to the guest and all the participants to the workshop on "Outcome Based Education". He gave some insights of the workshop and handed over the session to the Speaker of this Workshop Mr.Roshan Kavuri,HOD in Electronics and Computer Engineering, JBIET,HYDERABAD.



*Signature*  
Vignans Institute of Management & Technology For Women  
Kondapur(V),Ghatkesar(M),Medchal-Malkajgiri(D)-501301  
Telangana State



# VIGNAN'S INSTITUTE OF MANAGEMENT AND TECHNOLOGY FOR WOMEN

[Sponsored by Lavu Educational Society, Approved by AICTE, New Delhi & Affiliated to JNTU/H, Hyderabad.]

Kondapur (V), Ghatkesar (M), Medchal - Malkajgiri (D) - 501 301 TS INDIA

Phone: +08415 200006/07/08

Email: info.vmtw.in



Speaker started the programme by focusing on higher education which includes World class research with high quality teaching with special focus on research. He spoke about Vision which tell you where you want to go and mission which tell you where you are right now and what is the direction of moving towards the vision and how you are going to achieve it. Also, vision defines the end game and mission is roadmap that will take you to there. PEOs (Programme educational outcomes) should be derived from mission.

### **Implementation of OBE, Mapping & Attainment of COs and POs,**

Speaker briefed on key terms in OBE which are Vision, Mission, Goal, Objective, Outcome, PEO's, Graduate Attributes(GA), POs, COs, and COBs. Objective is teacher centered and Outcome is student centered. PEOs describe what graduates are expected to gain in his graduation. Skill, knowledge and attitude together form OBE. Employers expect life skills, employability skills, management skills, technical skills and discipline skills from the students



*AA*  
PRINCIPAL  
Vignans Institute of Management & Technology For Women  
Kondapur(V), Ghatkesar(M), Medchal-Malkajgiri(D)  
Telangana State



## Mapping & Attainment of COs and Pos.

Discussions continued on Programme Educational Objectives, Programme Outcomes, Course Outcomes and Blooms Taxonomy. PEOs are the expected achievements of graduates in their career that are expected to achieve during after few years of their graduation. PEOs must be quantifiable, suitable, realistic and attainable. Graduate Attributes (GAs) are prescribed by NBA and programme outcomes should be defined from these GAs. Mapping of PEO & PO and PO & CO is enlightened. Also, about Course Outcomes for each course using action verbs from blooms taxonomy.

## OBE based Teaching Learning

He also covered on teacher perspective and student perspective. These are best seen as specific intentions that include the steps to be taken to achieve our aims as teacher. Outcome describes what learners will be able to do when they have completed the course. For every course 5 to 7 course outcomes should be defined. Course Register should contain the following items; Syllabus, Session plan, attendance, Internal Assessment, Lecture Diary, Weekly Self Appraisal, Student performance and time table. One can use different Teaching Learning Methods depending upon the subject. Various Teaching Learning Methods are: Traditional method, lesson or session, Discussions, Seminars, Problem based, ICT, MOODLE, SWAYAM etc.

Speaker stated that OBE starts with a clear statement of knowledge, skill and attitude the graduate engineer will be able to demonstrate after successful completion of the course. The course or subject CO describes "What is the knowledge student has gained at the end of the course". Speaker suggested to follow Blooms taxonomy while preparing question papers.

Blooms taxonomy has 6 levels. Level-1: Understand, Level-2: Remember, Level-3: Apply, Level-4: Analyze, Level-5: Evaluate, Level-6: Create.



*Principal*  
Vignans Institute of Management & Technology For Women  
Kondapur(V), Ghatkesar(M), Medchal-Malkajgiri(D) - 501301  
Telangana State



# VIGNAN'S INSTITUTE OF MANAGEMENT AND TECHNOLOGY FOR WOMEN

[Sponsored by Lavu Educational Society, Approved by AICTE, New Delhi & Affiliated to JNTUH, Hyderabad.]

Kondapur (V), Ghatkesar (M), Medchal - Malkajgiri (D) - 501 301 TS INDIA

Phone: +08415 200006/07/08

Email: info.vmtw.in

## LEARNING OUTCOME

In conclusion, the One-Day Workshop on Outcome-Based Education (OBE) conducted at VMTW has been a success. The workshop aimed to provide faculty members with valuable insights and practical knowledge regarding the implementation of outcome-based approaches in their teaching and assessment practices.

Throughout the workshop, a total of 47 faculty members actively engaged in interactive sessions, discussions, and hands-on activities focused on understanding and applying the principles of outcome-based education. The workshop provided a comprehensive overview of the key concepts, methodologies, and tools associated with OBE, enabling participants to align their teaching strategies with defined learning outcomes.

Program Co-ordinator

(J.Sunil Kumar)



*ASH*  
PRINCIPAL  
Vignans Institute of Management & Technology For Women  
Kondapur(V),Ghatkesar(M),Medchal-Malkajgiri(D)-501301  
Telangana State



# VIGNAN'S INSTITUTE OF MANAGEMENT AND TECHNOLOGY FOR WOMEN

[Sponsored by Lavu Educational Society, Approved by AICTE, New Delhi & Affiliated to JNTUH, Hyderabad.]

Kondapur (V), Ghatkesar (M), Medchal - Malkajgiri (D) - 501 301 TS INDIA

Phone: +08415 20006/07/08

Email: info.vmtw.in

Date: 18/05/2019

## One Day Workshop on Outcome based Education

### List of Participants

S. No.	Name of the Faculty	Dept.
1.	Dr. K.Purnachand	CSE
2.	Dr. Gautami Latha Anga	CSE
3.	Mrs. Indrani Vasireddy	CSE
4.	Mr. Ravi Surarapu	CSE
5.	Mrs. Bhavani Geetha	CSE
6.	Mr. Nagaraju Narapogu	CSE
7.	Mr. Venukumar Nagu	CSE
8.	Mrs. Swaroopa Duli	CSE
9.	Mrs. Amara Jyothi Aramanda	CSE
10.	Mrs. Veena Chenigaram	CSE
11.	Mr. Praveen Kumar Kovuri	CSE
12.	Mr. S. Dilli Babu	CSE
13.	Mr. Vinay Bhushan Pillalamari	CSE
14.	Mrs. Deepthi Sri Dakuri	CSE
15.	Mr. K. Bharath Reddy	CSE
16.	Mrs. Ch. Mounika	CSE
17.	Mr. Kiran Kumar Lanka	EEE
18.	Mr. V. Sudheer Kumar	EEE
19.	Dr. Rakesh Muttukuru	ECE
20.	Dr. Narmada Alaparathi	ECE



*Principal*  
Vignan's Institute of Management & Technology for Women  
Kondapur(V), Ghatkesar(M), Medchal-Malkajgiri(D)-501 301  
Telangana State



# VIGNAN'S INSTITUTE OF MANAGEMENT AND TECHNOLOGY FOR WOMEN

[Sponsored by Lavu Educational Society, Approved by AICTE, New Delhi & Affiliated to JNTU, Hyderabad]

Kondapur (V), Ghatkesar (M), Medchal - Malkajgiri (D) - 501 301 TS INDIA

Phone: +08415 20006/0708

Email: info.vmtw.in

26.	Mr.Burugu Mahesh	ECE
27.	Mr.G. Ganesh Reddy	ECE
28.	Mr. Karthikpal Maddikunta	ECE
29.	Mr.Nagaraju Eduru	ECE
30.	Mr.Vinod Kumar Biyyala	ECE
31.	Mrs.Usharani Narasingam	ECE
32.	Mrs.Udaya Sri Bandi	ECE
33.	Ms.Hemalatha Maddigatla	ECE
34.	Dr.A.Premalatha	BSH
35.	Mr. Srinivasulu Thonukunuri	BSH
36.	Mrs.M S Bindu Madhavi	BSH
37.	Mr.Dileep Thotakuri	BSH
38.	Ms.Kavitha Donti	BSH
39.	Mr.Santhosh Kumar Kodam	BSH
40.	Mr.Komarelli Bal Reddy	BSH
41.	Mr.Satish Kuna	BSH
42.	Mr.A. Mallikarjuna	BSH
43.	Mr.Prasad Gattu	BSH
44.	Mrs.Vinutha Kandakuri	BSH
45.	Mr.C.Pradeep	BSH
46.	Mrs.Suzanshalini Vurum	BSH
47.	Mr.Venkatesham Boora	BSH

CO-ORDINATOR IQAC  
Co-ordinator

Internal Quality Assurance Cell  
Vignans Institute of Management & Technology For Women  
Kondapur (V), Ghatkesar (M), Medchal-Malkajgiri (D)-501301  
Telangana State

PRINCIPAL

PRINCIPAL  
Vignans Institute of Management & Technology For Women  
Kondapur(V),Ghatkesar(M),Medchal-Malkajgiri(D)-501301  
Telangana State.



PRINCIPAL  
Vignans Institute of Management & Technology For Women  
Kondapur(V),Ghatkesar(M),Medchal-Malkajgiri(D)-501301  
Telangana State



# VIGNAN'S INSTITUTE OF MANAGEMENT AND TECHNOLOGY FOR WOMEN

(Approved by AICTE, New Delhi & Affiliated to JNTUH, Hyderabad.)

Kondapur (V), Ghatkesar (M), Medchal - Malkajgiri (D) - 501 301

## CERTIFICATE OF PARTICIPATION

This is to certify that Mr./Ms./Mrs./Dr. K. Purnachand  
of CSE, Vignans Institute of Management and Technology for Women

has participated in One-Day Workshop on "OUTCOME BASED EDUCATION" held on  
18-05-2019, Organized by IQAC, Vignans Institute of Management and Technology  
for Women.

**Co-ordinator, IQAC**

Co-ordinator  
Internal Quality Assurance Cell  
Vignans Institute of Management & Technology For Women  
Kondapur (V), Ghatkesar (M), Medchal-Malkajgiri (D)-501301  
Telangana State



Principal  
Vignans Institute of Management & Technology For Women  
Kondapur (V), Ghatkesar (M), Medchal-Malkajgiri (D)-501301  
Telangana State

Principal

Vignans Institute of Management & Technology for Women  
Kondapur (V), Ghatkesar (M), Medchal-Malkajgiri (D)-501301  
Telangana State





# VIGNAN'S INSTITUTE OF MANAGEMENT AND TECHNOLOGY FOR WOMEN

(Approved by AICTE, New Delhi & Affiliated to JNTUH, Hyderabad.)

Kondapur (V), Ghatkesar (M), Medchal - Malkajgiri (D) - 501 301

## CERTIFICATE OF PARTICIPATION

This is to certify that Mr./Ms./Mrs./Dr. Gautami Latha Anja  
of CSE, Vignans Institute of Management and Technology for Women

has participated in One-Day Workshop on "OUTCOME BASED EDUCATION" held on  
18-05-2019, Organized by IQAC, Vignans Institute of Management and Technology  
for Women.

**Co-ordinator, IQAC**

Co-ordinator  
Internal Quality Assurance Cell  
Vignans Institute of Management & Technology For Women  
Kondapur (V), Ghatkesar (M), Medchal-Malkajgiri (D)-501301  
Telangana State



PRINCIPAL

Vignans Institute of Management & Technology For Women  
Kondapur(V),Ghatkesar(M),Medchal-Malkajgiri(D)-501301  
Telangana State

Principal

Vignans Institute of Management & Technology For Women  
Kondapur(V),Ghatkesar(M),Medchal-Malkajgiri(D)-501301  
Telangana State



# VIGNAN'S INSTITUTE OF MANAGEMENT AND TECHNOLOGY FOR WOMEN

(Approved by AICTE, New Delhi & Affiliated to JNTUH, Hyderabad.)

Kondapur (V), Ghatkesar (M), Medchal - Malkajgiri (D) - 501 301

## CERTIFICATE OF PARTICIPATION

This is to certify that Mr./Ms./Mrs. Indrani Vasireddy

of CSE, Vignans Institute of Management and Technology for Women

has participated in One-Day Workshop on "OUTCOME BASED EDUCATION" held on

18-05-2019, Organized by IQAC, Vignans Institute of Management and Technology

for Women.

**Co-ordinator, IQAC**

Co-ordinator

Internal Quality Assurance Cell  
Vignans Institute of Management & Technology For Women  
Kondapur (V), Ghatkesar (M), Medchal-Malkajgiri (D)-501301  
Telangana State



*Handwritten signature*

*Handwritten signature*

**Principal**

PRINCIPAL

Vignans Institute of Management & Technology For Women  
Kondapur(V), Ghatkesar(M), Medchal-Malkajgiri(D)-501301  
Telangana State



# VIGNAN'S INSTITUTE OF MANAGEMENT AND TECHNOLOGY FOR WOMEN

(Approved by AICTE, New Delhi & Affiliated to JNTUH, Hyderabad.)

Kondapur (V), Ghatkesar (M), Medchal - Malkajgiri (D) - 501 301

## CERTIFICATE OF PARTICIPATION

This is to certify that Mr./Ms./Mrs. Ravi Surapani

of CSE, Vignan's Institute of Management and Technology for Women

has participated in One-Day Workshop on "OUTCOME BASED EDUCATION" held on

18-05-2019, Organized by IQAC, Vignan's Institute of Management and Technology

for Women.

**Co-ordinator, IQAC**

Co-ordinator

Internal Quality Assurance Cell  
Vignan's Institute of Management & Technology For Women  
Kondapur (V), Ghatkesar (M), Medchal-Malkajgiri (D)-501301  
Telangana State



PRINCIPAL

Vignan's Institute of Management & Technology For Women  
Kondapur(V), Ghatkesar(M), Medchal-Malkajgiri(D)-501301  
Telangana State

Principal

Vignan's Institute of Management & Technology For Women  
Kondapur(V), Ghatkesar(M), Medchal-Malkajgiri(D)-501301  
Telangana State



# VIGNAN'S INSTITUTE OF MANAGEMENT AND TECHNOLOGY FOR WOMEN

(Approved by AICTE, New Delhi & Affiliated to JNTUH, Hyderabad.)

Kondapur (V), Ghatkesar (M), Medchal - Malkajgiri (D) - 501 301

## CERTIFICATE OF PARTICIPATION

This is to certify that Mr./Ms./Mrs. Bhovani Seetha

of CSE, Vignans Institute of Management and Technology for Women

has participated in One-Day Workshop on "OUTCOME BASED EDUCATION" held on

18-05-2019, Organized by IQAC, Vignans Institute of Management and Technology

for Women.

**Co-ordinator, IQAC**

Co-ordinator

Internal Quality Assurance Cell  
Vignans Institute of Management & Technology For Women  
Kondapur (V), Ghatkesar (M), Medchal-Malkajgiri (D)-501301  
Telangana State



PRINCIPAL

Principal

Vignans Institute of Management & Technology For Women  
Kondapur(V), Ghatkesar(M), Medchal-Malkajgiri(D)-501301  
Telangana State

PRINCIPAL  
Vignans Institute of Management & Technology For Women  
Kondapur(V), Ghatkesar(M), Medchal-Malkajgiri(D)-501301  
Telangana State



# VIGNAN'S INSTITUTE OF MANAGEMENT AND TECHNOLOGY FOR WOMEN

(Approved by AICTE, New Delhi & Affiliated to JNTUH, Hyderabad.)

Kondapur (V), Ghatkesar (M), Medchal - Malkajgiri (D) - 501 301

## CERTIFICATE OF PARTICIPATION

This is to certify that Mr./Ms./Mrs. Nagaraju Narapogu

of CSE, Vignans Institute of Management and Technology for Women

has participated in One-Day Workshop on "OUTCOME BASED EDUCATION" held on

18-05-2019, Organized by IQAC, Vignans Institute of Management and Technology

for Women.

**Co-ordinator, IQAC**

Co-ordinator

Internal Quality Assurance Cell

Vignans Institute of Management & Technology For Women

Kondapur (V), Ghatkesar (M), Medchal-Malkajgiri (D)-501301

Telangana State



*NAT*  
Principal  
Vignans Institute of Management & Technology for Women  
Kondapur (V), Ghatkesar (M), Medchal-Malkajgiri (D)-501301  
Telangana State

**Principal**

Principal

Vignans Institute of Management & Technology for Women

Kondapur (V), Ghatkesar (M), Medchal-Malkajgiri (D)-501301

Telangana State



# VIGNAN'S INSTITUTE OF MANAGEMENT AND TECHNOLOGY FOR WOMEN

(Approved by AICTE, New Delhi & Affiliated to JNTUH, Hyderabad.)

Kondapur (V), Ghatkesar (M), Medchal - Malkajgiri (D) - 501 301

## CERTIFICATE OF PARTICIPATION

This is to certify that Mr./Ms./Mrs. Senukumar Nagu  
of CSE, Vignan's Institute of Management and Technology for Women

has participated in One-Day Workshop on "OUTCOME BASED EDUCATION" held on  
18-05-2019, Organized by IQAC, Vignan's Institute of Management and Technology  
for Women.

**Co-ordinator, IQAC**  
Co-ordinator

Internal Quality Assurance Cell  
Vignan's Institute of Management & Technology For Women  
Kondapur (V), Ghatkesar (M), Medchal-Malkajgiri (D)-501301  
Telangana State



Principal  
Vignan's Institute of Management & Technology For Women  
Kondapur(V), Ghatkesar(M), Medchal-Malkajgiri(D)-501301  
Telangana State

Principal

Vignan's Institute of Management & Technology For Women  
Kondapur(V), Ghatkesar(M), Medchal-Malkajgiri(D)-501301  
Telangana State



# VIGNAN'S INSTITUTE OF MANAGEMENT AND TECHNOLOGY FOR WOMEN

(Approved by AICTE, New Delhi & Affiliated to JNTUH, Hyderabad.)

Kondapur (V), Ghatkesar (M), Medchal - Malkajgiri (D) - 501 301

## CERTIFICATE OF PARTICIPATION

This is to certify that Mr./Mrs./Mrs. Swaroop Suli

of CSE, Vignans Institute of Management and Technology for Women

has participated in One-Day Workshop on "OUTCOME BASED EDUCATION" held on

18-05-2019, Organized by IQAC, Vignans Institute of Management and Technology

for Women.

**Co-ordinator, IQAC**

Co-ordinator

Internal Quality Assurance Cell

Vignans Institute of Management & Technology For Women

Kondapur (V), Ghatkesar (M), Medchal-Malkajgiri (D)-501301

Telangana State



PRINCIPAL

Vignans Institute of Management & Technology For Women

Kondapur(V), Ghatkesar(M), Medchal-Malkajgiri(D)-501301

Telangana State

Principal

PRINCIPAL

Vignans Institute of Management & Technology For Women

Kondapur(V), Ghatkesar(M), Medchal-Malkajgiri(D)-501301

Telangana State



# VIGNAN'S INSTITUTE OF MANAGEMENT AND TECHNOLOGY FOR WOMEN

(Approved by AICTE, New Delhi & Affiliated to JNTUH, Hyderabad.)

Kondapur (V), Ghatkesar (M), Medchal - Malkajgiri (D) - 501 301

## CERTIFICATE OF PARTICIPATION

This is to certify that Mr./Ms./Mrs. Amara Jyothi Aravanda  
of CSE, Vignans Institute of Management and Technology for Women

has participated in One-Day Workshop on "OUTCOME BASED EDUCATION" held on  
18-05-2019, Organized by IQAC, Vignans Institute of Management and Technology  
for Women.

**Co-ordinator, IQAC**

Co-ordinator  
Internal Quality Assurance Cell  
Vignans Institute of Management & Technology For Women  
Kondapur (V), Ghatkesar (M), Medchal-Habash (D)-501301  
Telangana State



*Handwritten signature*  
PRINCIPAL  
Vignans Institute of Management & Technology For Women  
Kondapur (V), Ghatkesar (M), Medchal-Kanjigiri (D)-501301  
Telangana State

**Principal**

PRINCIPAL  
Vignans Institute of Management & Technology For Women  
Kondapur (V), Ghatkesar (M), Medchal-Kanjigiri (D)-501301  
Telangana State





# VIGNAN'S INSTITUTE OF MANAGEMENT AND TECHNOLOGY FOR WOMEN

(Approved by AICTE, New Delhi & Affiliated to JNTUH, Hyderabad.)

Kondapur (V), Ghatkesar (M), Medchal - Malkajiri (D) - 501 301

## CERTIFICATE OF PARTICIPATION

This is to certify that Mr./Ms./Mrs. Seena Chenigarani

of CSE, Vignan's Institute of Management and Technology for Women

has participated in One-Day Workshop on "OUTCOME BASED EDUCATION" held on

18-05-2019, Organized by IQAC, Vignan's Institute of Management and Technology

for Women.

**Co-ordinator, IQAC**

Co-ordinator

Internal Quality Assurance Cell

Vignan's Institute of Management & Technology For Women

Kondapur (V), Ghatkesar (M), Medchal-Malkajiri (D)-501301

Telangana State



*Handwritten signature*  
Principal  
Vignan's Institute of Management & Technology For Women  
Kondapur (V), Ghatkesar (M), Medchal-Malkajiri (D)-501301  
Telangana State

*Handwritten signature*  
Principal

Vignan's Institute of Management & Technology For Women  
Kondapur (V), Ghatkesar (M), Medchal-Malkajiri (D)-501301  
Telangana State



# VIGNAN'S INSTITUTE OF MANAGEMENT AND TECHNOLOGY FOR WOMEN

(Approved by AICTE, New Delhi & Affiliated to JNTUH, Hyderabad.)

Kondapur (V), Ghatkesar (M), Medchal - Malkajgiri (D) - 501 301

## CERTIFICATE OF PARTICIPATION

This is to certify that Mr./Ms./Mrs. Praveen Kumar Kovari

of CSE, Vignans Institute of Management and Technology - for Women

has participated in One-Day Workshop on "OUTCOME BASED EDUCATION" held on

18-05-2019, Organized by IQAC, Vignans Institute of Management and Technology

for Women.

**Co-ordinator, IQAC**

Co-ordinator

Internal Quality Assurance Cell

Vignans Institute of Management & Technology For Women

Kondapur (V), Ghatkesar (M), Medchal-Malkajgiri (D)-501301

Telangana State



PRINCIPAL

Vignans Institute of Management & Technology For Women

Kondapur (V), Ghatkesar (M), Medchal-Malkajgiri (D)-501301

Telangana State

Principal

PRINCIPAL

Vignans Institute of Management & Technology For Women

Kondapur (V), Ghatkesar (M), Medchal-Malkajgiri (D)-501301

Telangana State



# VIGNAN'S INSTITUTE OF MANAGEMENT AND TECHNOLOGY FOR WOMEN

(Approved by AICTE, New Delhi & Affiliated to JNTUH, Hyderabad.)

Kondapur (V), Ghatkesar (M), Medchal - Malkajgiri (D) - 501 301

## CERTIFICATE OF PARTICIPATION

This is to certify that Mr./Ms./Mrs. S. Dilli Babu

of CSE, Vignans Institute of Management and Technology for Women

has participated in One-Day Workshop on "OUTCOME BASED EDUCATION" held on

18-05-2019, Organized by IQAC, Vignans Institute of Management and Technology

for Women.

**Co-ordinator, IQAC**

Co-ordinator

Internal Quality Assurance Cell

Vignans Institute of Management & Technology For Women

Kondapur (V), Ghatkesar (M), Medchal-Malkajgiri (D)-501301

Telangana State



PRINCIPAL

Vignans Institute of Management & Technology for Women

Kondapur(V), Ghatkesar(M), Medchal-Malkajgiri(D)-501301

Telangana State

**Principal**

PRINCIPAL

Vignans Institute of Management & Technology for Women

Kondapur(V), Ghatkesar(M), Medchal-Malkajgiri(D)-501301

Telangana State



# VIGNAN'S INSTITUTE OF MANAGEMENT AND TECHNOLOGY FOR WOMEN

(Approved by AICTE, New Delhi & Affiliated to JNTUH, Hyderabad.)

Kondapur (V), Ghatkesar (M), Medchal - Malkajgiri (D) - 501 301

## CERTIFICATE OF PARTICIPATION

This is to certify that Mr./Ms./Mrs. *Srijoy Bhushan Pillalarnari*  
of *CSE, Vignana's Institute of Management and Technology for Women*  
has participated in One-Day Workshop on "OUTCOME BASED EDUCATION" held on  
18-05-2019, Organized by IQAC, Vignana's Institute of Management and Technology  
for Women.

**Co-ordinator, IQAC**

Internal Quality Assurance Cell  
Vignana's Institute of Management & Technology For Women  
Kondapur (V), Ghatkesar (M), Medchal-Malkajgiri (D)-501301  
Telangana State



PRINCIPAL  
Vignana's Institute of Management & Technology For Women  
Kondapur (V), Ghatkesar (M), Medchal-Malkajgiri (D)-501301  
Telangana State

**Principal**

PRINCIPAL  
Vignana's Institute of Management & Technology For Women  
Kondapur (V), Ghatkesar (M), Medchal-Malkajgiri (D)-501301  
Telangana State



# VIGNAN'S INSTITUTE OF MANAGEMENT AND TECHNOLOGY FOR WOMEN

(Approved by AICTE, New Delhi & Affiliated to JNTUH, Hyderabad.)

Kondapur (V), Ghatkesar (M), Medchal - Malkajgiri (D) - 501 301

## CERTIFICATE OF PARTICIPATION

This is to certify that Mr./Ms./Mrs. Deepthi Sri Baskari

of CSE, Vignans Institute of Management and Technology for Women

has participated in One-Day Workshop on "OUTCOME BASED EDUCATION" held on

18-05-2019, Organized by IQAC, Vignans Institute of Management and Technology

for Women.

**Co-ordinator, IQAC**

Co-ordinator  
Internal Quality Assurance Cell  
Vignans Institute of Management & Technology For Women  
Kondapur (V), Ghatkesar (M), Medchal-Malkajgiri (D)-501301  
Telangana State



PRINCIPAL

Vignans Institute of Management & Technology For Women  
Kondapur (V), Ghatkesar (M), Medchal-Malkajgiri (D)-501301  
Telangana State

Principal

PRINCIPAL  
Vignans Institute of Management & Technology For Women  
Kondapur (V), Ghatkesar (M), Medchal-Malkajgiri (D)-501301  
Telangana State



# VIGNAN'S INSTITUTE OF MANAGEMENT AND TECHNOLOGY FOR WOMEN

(Approved by AICTE, New Delhi & Affiliated to JNTUH, Hyderabad.)

Kondapur (V), Ghatkesar (M), Medchal - Malkajgiri (D) - 501 301

## CERTIFICATE OF PARTICIPATION

This is to certify that Mr./Ms./Mrs. K. Bharath Reddy  
of CSE, Vignan's Institute Management and Technology for Women

has participated in One-Day Workshop on "OUTCOME BASED EDUCATION" held on  
18-05-2019, Organized by IQAC, Vignan's Institute of Management and Technology  
for Women.

**Co-ordinator, IQAC**

Co-ordinator

Internal Quality Assurance Cell  
Vignan's Institute of Management & Technology For Women  
Kondapur (V), Ghatkesar (M), Medchal-Malkajgiri (D)-501301  
Telangana State



PRINCIPAL

Vignan's Institute of Management & Technology For Women  
Kondapur (V), Ghatkesar (M), Medchal - Malkajgiri (D) - 501301

Principal

PRINCIPAL

Vignan's Institute of Management & Technology For Women  
Kondapur (V), Ghatkesar (M), Medchal - Malkajgiri (D) - 501301

తెలంగాణ ప్రభుత్వం



# VIGNAN'S INSTITUTE OF MANAGEMENT AND TECHNOLOGY FOR WOMEN

(Approved by AICTE, New Delhi & Affiliated to JNTUH, Hyderabad.)

Kondapur (V), Ghatkesar (M), Medchal - Malkajgiri (D) - 501 301

## CERTIFICATE OF PARTICIPATION

This is to certify that Mr./Mrs. Ch. Moulika

of CSE, Vignan's Institute of Management and Technology for Women

has participated in One-Day Workshop on "OUTCOME BASED EDUCATION" held on

18-05-2019, Organized by IQAC, Vignan's Institute of Management and Technology

for Women.

**Co-ordinator, IQAC**

Co-ordinator

Internal Quality Assurance Cell  
Vignan's Institute of Management & Technology For Women  
Kondapur (V), Ghatkesar (M), Medchal-Malkajgiri (D)-501301  
Telangana State



Vignan's Institute of Management & Technology For Women  
Kondapur (V), Ghatkesar (M), Medchal-Malkajgiri (D)-501301  
Telangana State

**Principal**

PROVINCIAL

Vignan's Institute of Management & Technology For Women  
Kondapur (V), Ghatkesar (M), Medchal-Malkajgiri (D)-501301  
Telangana State



# VIGNAN'S INSTITUTE OF MANAGEMENT AND TECHNOLOGY FOR WOMEN

(Approved by AICTE, New Delhi & Affiliated to JNTUH, Hyderabad.)

Kondapur (V), Ghatkesar (M), Medchal - Malkajgiri (D) - 501 301

## CERTIFICATE OF PARTICIPATION

This is to certify that Mr./Ms./Mrs. Kiran Kumar Lokesh  
of EEE, Vignans Institute of Management and Technology for Women

has participated in One-Day Workshop on "OUTCOME BASED EDUCATION" held on  
18-05-2019, Organized by IQAC, Vignans Institute of Management and Technology  
for Women.

**Co-ordinator, IQAC**

Co-ordinator  
Internal Quality Assurance Cell  
Vignans Institute of Management & Technology For Women  
Kondapur (V), Ghatkesar (M), Medchal-Malkajgiri (D)-501301  
Telangana State



PRINCIPAL

Vignans Institute of Management & Technology For Women  
Kondapur(V), Ghatkesar(M), Medchal-Malkajgiri(D)-501301  
Telangana State

Principal

PRINCIPAL  
Vignans Institute of Management & Technology For Women  
Kondapur(V), Ghatkesar(M), Medchal-Malkajgiri(D)-501301  
Telangana State





# VIGNAN'S INSTITUTE OF MANAGEMENT AND TECHNOLOGY FOR WOMEN

(Approved by AICTE, New Delhi & Affiliated to JNTUH, Hyderabad.)

Kondapur (V), Ghatkesar (M), Medchal - Malkajgiri (D) - 501 301

## CERTIFICATE OF PARTICIPATION

This is to certify that Mr./Ms./Mrs. U. Sudheer Kumar

of EEE, Vignans Institute of Management and Technology for Women

has participated in One-Day Workshop on "OUTCOME BASED EDUCATION" held on

18-05-2019, Organized by IQAC, Vignans Institute of Management and Technology

for Women.

**Co-ordinator, IQAC**

Co-ordinator

Internal Quality Assurance Cell

Vignans Institute of Management & Technology For Women

Kondapur (V), Ghatkesar (M), Medchal-Malkajgiri (D)-501301

TeLANGANA STATE

PRINCIPAL

Vignans Institute of Management & Technology For Women  
Kondapur(V), Ghatkesar(M), Medchal-Malkajgiri(D)-501301  
Telangana State

Principal

PRINCIPAL

Vignans Institute of Management & Technology For Women  
Kondapur(V), Ghatkesar(M), Medchal-Malkajgiri(D)-501301  
Telangana State



# VIGNAN'S INSTITUTE OF MANAGEMENT AND TECHNOLOGY FOR WOMEN

(Approved by AICTE, New Delhi & Affiliated to JNTUH, Hyderabad.)

Kondapur (V), Ghatkesar (M), Medchal - Malkajgiri (D) - 501 301

## CERTIFICATE OF PARTICIPATION

This is to certify that Mr./Ms./Mrs. Dr. Rakesh Murtukuri

of ECE, Vignan's Institute of Management and Technology for Women

has participated in One-Day Workshop on "OUTCOME BASED EDUCATION" held on

18-05-2019, Organized by IQAC, Vignan's Institute of Management and Technology for Women.



  
**Co-ordinator, IQAC**  
Co-ordinator

Internal Quality Assurance Cell  
Vignan's Institute of Management & Technology For Women  
Kondapur (V), Ghatkesar (M), Medchal-Malkajgiri (D)-501301  
Telangana State

  
Principal  
Vignan's Institute of Management & Technology For Women  
Kondapur (V), Ghatkesar (M), Medchal-Malkajgiri (D)-501301  
Telangana State

  
**Principal**

Vignan's Institute of Management & Technology For Women  
Kondapur (V), Ghatkesar (M), Medchal-Malkajgiri (D)-501301  
Telangana State



# VIGNAN'S INSTITUTE OF MANAGEMENT AND TECHNOLOGY FOR WOMEN

(Approved by AICTE, New Delhi & Affiliated to JNTUH, Hyderabad.)

Kondapur (V), Ghatkesar (M), Medchal - Malkajgiri (D) - 501 301

## CERTIFICATE OF PARTICIPATION

This is to certify that Mr./Ms./Mrs./Dr. Narmada Alaparthi  
of ECE, Vignans Institute of Management & Technology for Women

has participated in One-Day Workshop on "OUTCOME BASED EDUCATION" held on

18-05-2019, Organized by IQAC, Vignans Institute of Management and Technology

for Women.

**Co-ordinator, IQAC**

Co-ordinator

Internal Quality Assurance Cell

Vignans Institute of Management & Technology For Women

Kondapur (V), Ghatkesar (M), Medchal-Malkajgiri (D)-501301

Telangana State



PRINCIPAL  
Vignans Institute of Management & Technology For Women  
Kondapur (V), Ghatkesar (M), Medchal-Malkajgiri (D)-501301

Telangana State

**Principal**

PRINCIPAL

Vignans Institute of Management & Technology For Women  
Kondapur (V), Ghatkesar (M), Medchal-Malkajgiri (D)-501301

Telangana State



# VIGNAN'S INSTITUTE OF MANAGEMENT AND TECHNOLOGY FOR WOMEN

(Approved by AICTE, New Delhi & Affiliated to JNTUH, Hyderabad.)

Kondapur (V), Ghatkesar (M), Medchal - Malkajgiri (D) - 501 301

## CERTIFICATE OF PARTICIPATION

This is to certify that Mr./Ms./Mrs./Dr. Mallavi Jeda Kumar  
of ECE, Vignan's Institute of Management and Technology for Women

has participated in One-Day Workshop on "OUTCOME BASED EDUCATION" held on  
18-05-2019, Organized by IQAC, Vignan's Institute of Management and Technology  
for Women.

**Co-ordinator, IQAC**  
Co-ordinator

Internal Quality Assurance Cell  
Vignan's Institute of Management & Technology For Women  
Kondapur (V), Ghatkesar (M), Medchal-Malkajgiri (D)-501301  
Telangana State



*AAsh*  
Vignan's Institute of Management & Technology For Women  
Kondapur (V), Ghatkesar (M), Medchal-Malkajgiri (D)-501301  
Telangana State

**Principal**

Principal  
Vignan's Institute of Management & Technology For Women  
Kondapur (V), Ghatkesar (M), Medchal-Malkajgiri (D)-501301  
Telangana State



# VIGNAN'S INSTITUTE OF MANAGEMENT AND TECHNOLOGY FOR WOMEN

(Approved by AICTE, New Delhi & Affiliated to JNTUH, Hyderabad.)

Kondapur (V), Ghatkesar (M), Medchal - Malkajgiri (D) - 501 301

## CERTIFICATE OF PARTICIPATION

This is to certify that Mr./Ms./Mrs. Sarvil Kumar Tengili

of ECE, Vignan's Institute of Management and Technology for Women

has participated in One-Day Workshop on "OUTCOME BASED EDUCATION" held on

18-05-2019, Organized by IQAC, Vignan's Institute of Management and Technology

for Women.

**Co-ordinator, IQAC**  
Co-ordinator

Internal Quality Assurance Cell  
Vignan's Institute of Management & Technology For Women  
Kondapur (V), Ghatkesar (M), Medchal-Malkajgiri (D)-501301  
Telangana State



**Principal**  
Vignan's Institute of Management & Technology for Women  
Kondapur (V), Ghatkesar (M), Medchal-Malkajgiri (D)-501301  
Telangana State

**Principal**

**Principal**  
Vignan's Institute of Management & Technology for Women  
Kondapur (V), Ghatkesar (M), Medchal-Malkajgiri (D)-501301  
Telangana State



# VIGNAN'S INSTITUTE OF MANAGEMENT AND TECHNOLOGY FOR WOMEN

(Approved by AICTE, New Delhi & Affiliated to JNTUH, Hyderabad.)

Kondapur (V), Ghatkesar (M), Medchal - Malkajgiri (D) - 501 301

## CERTIFICATE OF PARTICIPATION

This is to certify that Mr./Ms./Mrs. Vijay Kumar R. Urkunde

of ECE, Vignan's Institute of Management and Technology for Women

has participated in One-Day Workshop on "OUTCOME BASED EDUCATION" held on  
18-05-2019, Organized by IQAC, Vignan's Institute of Management and Technology  
for Women.

**Co-ordinator, IQAC**

Co-ordinator

Internal Quality Assurance Cell  
Vignan's Institute of Management & Technology For Women  
Kondapur (V), Ghatkesar (M), Medchal-Malkajgiri (D)-501301  
Telangana State



Principal

**Principal**

Principal

Vignan's Institute of Management & Technology for Women  
Kondapur (V), Ghatkesar (M), Medchal-Malkajgiri (D)-501301  
Telangana State



# VIGNAN'S INSTITUTE OF MANAGEMENT AND TECHNOLOGY FOR WOMEN

(Approved by AICTE, New Delhi & Affiliated to JNTUH, Hyderabad.)

Kondapur (V), Ghatkesar (M), Medchal - Malkajgiri (D) - 501 301

## CERTIFICATE OF PARTICIPATION

This is to certify that Mr./Ms./Mrs. Ashok Reddy Katta

of ECE, Vignans Institute of Management and Technology for Women

has participated in One-Day Workshop on "OUTCOME BASED EDUCATION" held on

18-05-2019, Organized by IQAC, Vignans Institute of Management and Technology

for Women.

**Co-ordinator, IQAC**

Co-ordinator

Internal Quality Assurance Cell

Vignans Institute of Management & Technology For Women

Kondapur (V), Ghatkesar (M), Medchal-Malkajgiri (D)-501301

Telangana State



PRINCIPAL

Vignans Institute of Management & Technology For Women

Kondapur (V), Ghatkesar (M), Medchal-Malkajgiri (D)-501301

Telangana State

Principal

PRINCIPAL

Vignans Institute of Management & Technology For Women

Kondapur (V), Ghatkesar (M), Medchal-Malkajgiri (D)-501301

Telangana State



# VIGNAN'S INSTITUTE OF MANAGEMENT AND TECHNOLOGY FOR WOMEN

(Approved by AICTE, New Delhi & Affiliated to JNTUH, Hyderabad.)

Kondapur (V), Ghatkesar (M), Medchal - Malkajgiri (D) - 501 301

## CERTIFICATE OF PARTICIPATION

This is to certify that Mr./Ms./Mrs. Burugula Mahesh

of ECE, Vignans Institute of Management and Technology for Women

has participated in One-Day Workshop on "OUTCOME BASED EDUCATION" held on

18-05-2019, Organized by IQAC, Vignans Institute of Management and Technology

for Women.

**Co-ordinator, IQAC**

Co-ordinator

Internal Quality Assurance Cell  
Vignans Institute of Management & Technology For Women  
Kondapur (M), Ghatkesar (M), Medchal-Malkajgiri (DY)-501301  
Telangana State



PRINCIPAL

Vignans Institute of Management & Technology For Women  
Kondapur (M), Ghatkesar (M), Medchal-Malkajgiri (DY)-501301  
Telangana State

**Principal**

PRINCIPAL  
Vignans Institute of Management & Technology For Women  
Kondapur (M), Ghatkesar (M), Medchal-Malkajgiri (DY)-501301  
Telangana State





# VIGNAN'S INSTITUTE OF MANAGEMENT AND TECHNOLOGY FOR WOMEN

(Approved by AICTE, New Delhi & Affiliated to JNTUH, Hyderabad.)

Kondapur (V), Ghatkesar (M), Medchal - Malkajgiri (D) - 501 301

## CERTIFICATE OF PARTICIPATION

This is to certify that Mr./Ms./Mrs. G. Ganesh Reddy

of ECE, Vignans Institute of Management and Technology for Women

has participated in One-Day Workshop on "OUTCOME BASED EDUCATION" held on

18-05-2019, Organized by IQAC, Vignans Institute of Management and Technology

for Women.

**Co-ordinator, IQAC**

Co-ordinator

Internal Quality Assurance Cell

Vignans Institute of Management & Technology For Women

Kondapur (V), Ghatkesar (M), Medchal-Malkajgiri (D)-501301

Telangana State



PRINCIPAL

Vignans Institute of Management & Technology For Women

Kondapur (V), Ghatkesar (M), Medchal-Malkajgiri (D)-501301

Telangana State

Principal

Principal

Vignans Institute of Management & Technology For Women

Kondapur (V), Ghatkesar (M), Medchal-Malkajgiri (D)-501301

Telangana State



# VIGNAN'S INSTITUTE OF MANAGEMENT AND TECHNOLOGY FOR WOMEN

(Approved by AICTE, New Delhi & Affiliated to JNTUH, Hyderabad.)

Kondapur (V), Ghatkesar (M), Medchal - Malkajgiri (D) - 501 301

## CERTIFICATE OF PARTICIPATION

This is to certify that Mr./Ms./Mrs. Karthikapal Madhikanta

of ECE, Vignana's Institute of Management and Technology For Women

has participated in One-Day Workshop on "OUTCOME BASED EDUCATION" held on

18-05-2019, Organized by IQAC, Vignana's Institute of Management and Technology

for Women.

**Co-ordinator, IQAC**

Co-ordinator

Internal Quality Assurance Cell

Vignana's Institute of Management & Technology For Women

Kondapur (V), Ghatkesar (M), Medchal-Malkajgiri (D)-501301

Telangana State



PRINCIPAL

Vignana's Institute of Management & Technology For Women

Kondapur (V), Ghatkesar (M), Medchal-Malkajgiri (D)-501301

Telangana State

Principal

PRINCIPAL

Vignana's Institute of Management & Technology For Women

Kondapur (V), Ghatkesar (M), Medchal-Malkajgiri (D)-501301

Telangana State



# VIGNAN'S INSTITUTE OF MANAGEMENT AND TECHNOLOGY FOR WOMEN

(Approved by AICTE, New Delhi & Affiliated to JNTUH, Hyderabad.)

Kondapur (V), Ghatkesar (M), Medchal - Malkajgiri (D) - 501 301

## CERTIFICATE OF PARTICIPATION

This is to certify that Mr./Ms./Mrs. Magarajit Echuri

of ECE, Vignans Institute of Management and Technology for Women

has participated in One-Day Workshop on "OUTCOME BASED EDUCATION" held on 18-05-2019, Organized by IQAC, Vignans Institute of Management and Technology for Women.

**Co-ordinator, IQAC**  
Co-ordinator  
Internal Quality Assurance Cell  
Vignans Institute of Management & Technology For Women  
Kondapur (V), Ghatkesar (M), Medchal-Malkajgiri (D)-501301  
Telangana State



**PRINCIPAL**  
Vignans Institute of Management & Technology for Women  
Kondapur (V), Ghatkesar (M), Medchal-Malkajgiri (D)-501301  
Telangana State

**Principal**  
PRINCIPAL  
Vignans Institute of Management & Technology For Women  
Kondapur (V), Ghatkesar (M), Medchal-Malkajgiri (D)-501301  
Telangana State



# VIGNAN'S INSTITUTE OF MANAGEMENT AND TECHNOLOGY FOR WOMEN

(Approved by AICTE, New Delhi & Affiliated to JNTUH, Hyderabad.)

Kondapur (V), Ghatkesar (M), Medchal - Malkajgiri (D) - 501 301

## CERTIFICATE OF PARTICIPATION

This is to certify that Mr./Ms./Mrs. Sinodkumar Biyyala

of ECE, Vignan's Institute of Management and Technology for Women

has participated in One-Day Workshop on "OUTCOME BASED EDUCATION" held on

18-05-2019, Organized by IQAC, Vignan's Institute of Management and Technology

for Women.

**Co-ordinator, IQAC**

Co-ordinator

Internal Quality Assurance Cell

Vignan's Institute of Management & Technology For Women

Kondapur (V), Ghatkesar (M), Medchal-Malkajgiri (D)-501301

Telangana State



PRINCIPAL

Vignan's Institute of Management & Technology For Women

Kondapur (V), Ghatkesar (M), Medchal-Malkajgiri (D)-501301

Telangana State

Principal

PRINCIPAL

Vignan's Institute of Management & Technology For Women

Kondapur (V), Ghatkesar (M), Medchal-Malkajgiri (D)-501301

Telangana State



# VIGNAN'S INSTITUTE OF MANAGEMENT AND TECHNOLOGY FOR WOMEN

(Approved by AICTE, New Delhi & Affiliated to JNTUH, Hyderabad.)

Kondapur (V), Ghatkesar (M), Medchal - Malkajgiri (D) - 501 301

## CERTIFICATE OF PARTICIPATION

This is to certify that Mr./Ms./Mrs. Usharani Narosingam

of ECE, Vignan's Institute of Management and Technology for Women

has participated in One-Day Workshop on "OUTCOME BASED EDUCATION" held on

18-05-2019, Organized by IQAC, Vignan's Institute of Management and Technology

for Women.

**Co-ordinator, IQAC**

Co-ordinator

Internal Quality Assurance Cell

Vignan's Institute of Management & Technology For Women

Kondapur (V), Ghatkesar (M), Medchal-Malkajgiri (D)-501301

Telangana State



PRINCIPAL

Vignan's Institute of Management & Technology For Women  
Kondapur (V), Ghatkesar (M), Medchal-Malkajgiri (D)-501301

Telangana State

Principal

PRINCIPAL

Vignan's Institute of Management & Technology For Women

Kondapur (V), Ghatkesar (M), Medchal-Malkajgiri (D)-501301

Telangana State



# VIGNAN'S INSTITUTE OF MANAGEMENT AND TECHNOLOGY FOR WOMEN

(Approved by AICTE, New Delhi & Affiliated to JNTUH, Hyderabad.)

Kondapur (V), Ghatkesar (M), Medchal - Malkajgiri (D) - 501 301

## CERTIFICATE OF PARTICIPATION

This is to certify that Mr./Ms./Mrs. Udaya Sri Bandi

of ECE, Vignans Institute of Management and Technology for Women

has participated in One-Day Workshop on "OUTCOME BASED EDUCATION" held on  
18-05-2019, Organized by IQAC, Vignans Institute of Management and Technology  
for Women.

**Co-ordinator, IQAC**  
Co-ordinator

Internal Quality Assurance Cell  
Vignans Institute of Management & Technology For Women  
Kondapur (V), Ghatkesar (M), Medchal-Hazajgi (D)-501301  
Telangana State



PRINCIPAL  
Vignans Institute of Management & Technology For Women  
Kondapur (V), Ghatkesar (M), Medchal-Hazajgi (D) - 501301  
Telangana State

Principal

PRINCIPAL

Vignans Institute of Management & Technology For Women  
Kondapur (V), Ghatkesar (M), Medchal-Hazajgi (D) - 501301  
Telangana State



# VIGNAN'S INSTITUTE OF MANAGEMENT AND TECHNOLOGY FOR WOMEN

(Approved by AICTE, New Delhi & Affiliated to JNTUH, Hyderabad.)

Kondapur (V), Ghatkesar (M), Medchal - Malkajgiri (D) - 501 301

## CERTIFICATE OF PARTICIPATION

This is to certify that Mr./Ms./Mrs. Hemalatha Maddigalla

of ECE, Vignan's Institute of Management and Technology for Women

has participated in One-Day Workshop on "OUTCOME BASED EDUCATION" held on

18-05-2019, Organized by IQAC, Vignan's Institute of Management and Technology

for Women.

**Co-ordinator, IQAC**  
Co-ordinator

Internal Quality Assurance Cell  
Vignan's Institute of Management & Technology For Women  
Kondapur (V), Ghatkesar (M), Medchal-Malkajgiri (D)-501301  
Telangana State



*Handwritten signature*  
Vignan's Institute of Management & Technology for Women  
Kondapur(V), Ghatkesar(M), Medchal-Malkajgiri(D)-501301  
Telangana State

*Handwritten signature*

**Principal**

Principal  
Vignan's Institute of Management & Technology For Women  
Kondapur(V), Ghatkesar(M), Medchal-Malkajgiri(D)-501301  
Telangana State



# VIGNAN'S INSTITUTE OF MANAGEMENT AND TECHNOLOGY FOR WOMEN

(Approved by AICTE, New Delhi & Affiliated to JNTUH, Hyderabad.)

Kondapur (V), Ghatkesar (M), Medchal - Malkajgiri (D) - 501 301

## CERTIFICATE OF PARTICIPATION

This is to certify that Mr./Ms./Mrs. Dr. A. Premalatha  
of B.S.H. Vignans Institute of Management and Technology for Women

has participated in One-Day Workshop on "OUTCOME BASED EDUCATION" held on  
18-05-2019, Organized by IQAC, Vignans Institute of Management and Technology  
for Women.

**Co-ordinator, IQAC**

Co-ordinator  
Internal Quality Assurance Cell  
Vignans Institute of Management & Technology For Women  
Kondapur (V), Ghatkesar (M), Medchal-Malkajgiri (D)-501301  
Telangana State



**Principal**  
Vignans Institute of Management & Technology For Women  
Kondapur (V), Ghatkesar (M), Medchal-Malkajgiri (D)-501301  
Telangana State

**Principal**

**Principal**  
Vignans Institute of Management & Technology For Women  
Kondapur (V), Ghatkesar (M), Medchal-Malkajgiri (D)-501301  
Telangana State





# VIGNAN'S INSTITUTE OF MANAGEMENT AND TECHNOLOGY FOR WOMEN

(Approved by AICTE, New Delhi & Affiliated to JNTUH, Hyderabad.)

Kondapur (V), Ghatkesar (M), Medchal - Malkajgiri (D) - 501 301

## CERTIFICATE OF PARTICIPATION

This is to certify that Mr./Ms./Mrs. Srinivasulu Hanikumari

of B.S.H. Vignan's Institute of Management and Technology for Women

has participated in One-Day Workshop on "OUTCOME BASED EDUCATION" held on

18-05-2019, Organized by IQAC, Vignan's Institute of Management and Technology

for Women.

**Co-ordinator, IQAC**

Co-ordinator

Internal Quality Assurance Cell

Vignan's Institute of Management & Technology For Women

Kondapur (V), Ghatkesar (M), Medchal-Malkajgiri (D)-501301

Telangana State



PRINCIPAL

Vignan's Institute of Management & Technology For Women

Kondapur(V), Ghatkesar(M), Medchal-Malkajgiri(D)-501301

Telangana State

Principal

PRINCIPAL

Vignan's Institute of Management & Technology For Women

Kondapur(V), Ghatkesar(M), Medchal-Malkajgiri(D)-501301

Telangana State



# VIGNAN'S INSTITUTE OF MANAGEMENT AND TECHNOLOGY FOR WOMEN

(Approved by AICTE, New Delhi & Affiliated to JNTUH, Hyderabad.)

Kondapur (V), Ghatkesar (M), Medchal - Malkajgiri (D) - 501 301

## CERTIFICATE OF PARTICIPATION

This is to certify that Mt./Ms./Mrs. M.S. Bindu Madhavi  
of BSH, Vignan's Institute of Management and Technology for Women

has participated in One-Day Workshop on "OUTCOME BASED EDUCATION" held on  
18-05-2019, Organized by IQAC, Vignan's Institute of Management and Technology  
for Women.

**Co-ordinator, IQAC**

Co-ordinator  
Internal Quality Assurance Cell  
Vignan's Institute of Management & Technology For Women  
Kondapur (V), Ghatkesar (M), Medchal-Malkajgiri (D)-501301  
Telangana State



Principal  
Vignan's Institute of Management & Technology For Women  
Kondapur(V), Ghatkesar(M), Medchal-Malkajgiri(D)-501301  
Telangana State

Principal  
PRINCIPAL  
Vignan's Institute of Management & Technology For Women  
Kondapur(V), Ghatkesar(M), Medchal-Malkajgiri(D)-501301  
Telangana State



# VIGNAN'S INSTITUTE OF MANAGEMENT AND TECHNOLOGY FOR WOMEN

(Approved by AICTE, New Delhi & Affiliated to JNTUH, Hyderabad.)

Kondapur (V), Ghatkesar (M), Medchal - Malkajgiri (D) - 501 301

## CERTIFICATE OF PARTICIPATION

This is to certify that Mr./Ms./Mrs. Dileep Thotakuri

of BSH, Vignan's Institute of Management and Technology for Women

has participated in One-Day Workshop on "OUTCOME BASED EDUCATION" held on  
18-05-2019, Organized by IQAC, Vignan's Institute of Management and Technology  
for Women.

**Co-ordinator, IQAC**

Co-ordinator

Internal Quality Assurance Cell

Vignan's Institute of Management & Technology For Women

Kondapur (V), Ghatkesar (M), Medchal-Malkajgiri (D)-501301

Telangana State

PRINCIPAL

Vignan's Institute of Management & Technology For Women

Kondapur(V), Ghatkesar(M), Medchal-Malkajgiri(D)-501301

Telangana State

**Principal**

PRINCIPAL

Vignan's Institute of Management & Technology for Women

Kondapur(V), Ghatkesar(M), Medchal-Malkajgiri(D)-501301

Telangana State



# VIGNAN'S INSTITUTE OF MANAGEMENT AND TECHNOLOGY FOR WOMEN

(Approved by AICTE, New Delhi & Affiliated to JNTUH, Hyderabad.)

Kondapur (V), Ghatkesar (M), Medchal - Malkajgiri (D) - 501 301

## CERTIFICATE OF PARTICIPATION

This is to certify that Mr./Ms./Mrs. Kavitha Bonti

of BSH, Vignan's Institute of Management and Technology for Women

has participated in One-Day Workshop on "OUTCOME BASED EDUCATION" held on  
18-05-2019, Organized by IQAC, Vignan's Institute of Management and Technology  
for Women.

**Co-ordinator, IQAC**

Co-ordinator

Internal Quality Assurance Cell  
Vignan's Institute of Management & Technology For Women  
Kondapur (V), Ghatkesar (M), Medchal-Malkajgiri (D)-501301  
Telangana State



**Principal**

Principal

Vignan's Institute of Management & Technology for Women  
Kondapur (V), Ghatkesar (M), Medchal-Malkajgiri (D)-501301  
Telangana State



# VIGNAN'S INSTITUTE OF MANAGEMENT AND TECHNOLOGY FOR WOMEN

(Approved by AICTE, New Delhi & Affiliated to JNTUH, Hyderabad.)

Kondapur (V), Ghatkesar (M), Medchal - Malkajgiri (D) - 501 301

## CERTIFICATE OF PARTICIPATION

This is to certify that Mr./Ms./Mrs. Santosh Kumar Kodam  
of BSH, Vignans Institute of Management and Technology for Women

has participated in One-Day Workshop on "OUTCOME BASED EDUCATION" held on  
18-05-2019, Organized by IQAC, Vignans Institute of Management and Technology  
for Women.

**Co-ordinator, IQAC**  
Co-ordinator

Internal Quality Assurance Cell  
Vignans Institute of Management & Technology For Women  
Kondapur (V), Ghatkesar (M), Medchal-Malkajgiri (D)-501301  
Telangana State



PRINCIPAL  
Vignans Institute of Management & Technology for Women  
Kondapur (V), Ghatkesar (M), Medchal-Malkajgiri (D)-501301  
Telangana State

Principal

PRINCIPAL  
Vignans Institute of Management & Technology for Women  
Kondapur (V), Ghatkesar (M), Medchal-Malkajgiri (D)-501301  
Telangana State



# VIGNAN'S INSTITUTE OF MANAGEMENT AND TECHNOLOGY FOR WOMEN

(Approved by AICTE, New Delhi & Affiliated to JNTUH, Hyderabad.)

Kondapur (V), Ghatkesar (M), Medchal - Malkajgiri (D) - 501 301

## CERTIFICATE OF PARTICIPATION

This is to certify that Mr./Ms./Mrs. Komarelli BalReddy  
of BSH, Vignana's Institute of Management and Technology for Women

has participated in One-Day Workshop on "OUTCOME BASED EDUCATION" held on  
18-05-2019, Organized by IQAC, Vignana's Institute of Management and Technology  
for Women.

**Co-ordinator, IQAC**

Co-ordinator  
Internal Quality Assurance Cell  
Vignana's Institute of Management & Technology For Women  
Kondapur (V), Ghatkesar (M), Medchal-Malkajgiri (D)-501301  
Telangana State



PRINCIPAL

Vignana's Institute of Management & Technology For Women  
Kondapur (V), Ghatkesar (M), Medchal-Malkajgiri (D)-501301

Principal

PRINCIPAL

Vignana's Institute of Management & Technology For Women  
Kondapur (V), Ghatkesar (M), Medchal-Malkajgiri (D)-501301

Telangana State



# VIGNAN'S INSTITUTE OF MANAGEMENT AND TECHNOLOGY FOR WOMEN

(Approved by AICTE, New Delhi & Affiliated to JNTUH, Hyderabad.)

Kondapur (V), Ghatkesar (M), Medchal - Malkajgiri (D) - 501 301

## CERTIFICATE OF PARTICIPATION

This is to certify that Mr./Ms./Mrs. Sarthish Kana

of B.S.H., Vignan's Institute of Management and Technology for Women

has participated in One-Day Workshop on "OUTCOME BASED EDUCATION" held on

18-05-2019, Organized by IQAC, Vignan's Institute of Management and Technology

for Women.

**Co-ordinator, IQAC**

Co-ordinator

Internal Quality Assurance Cell  
Vignan's Institute of Management & Technology For Women  
Kondapur (V), Ghatkesar (M), Medchal-Malkajgiri (D)-501301  
Telangana State



PRINCIPAL

**Principal**

Principal

Vignan's Institute of Management & Technology For Women  
Kondapur (V), Ghatkesar (M), Medchal-Malkajgiri (D)-501301  
Telangana State



# VIGNAN'S INSTITUTE OF MANAGEMENT AND TECHNOLOGY FOR WOMEN

(Approved by AICTE, New Delhi & Affiliated to JNTUH, Hyderabad.)

Kondapur (V), Ghatkesar (M), Medchal - Malkajgiri (D) - 501 301

## CERTIFICATE OF PARTICIPATION

This is to certify that Mr./Ms./Mrs. A. Mallikavijaya

of BSH, Vignans Institute of Management and Technology for Women

has participated in One-Day Workshop on "OUTCOME BASED EDUCATION" held on

18-05-2019, Organized by IQAC, Vignans Institute of Management and Technology for Women.

**Co-ordinator, IQAC**

Co-ordinator  
Internal Quality Assurance Cell  
Vignans Institute of Management & Technology For Women  
Kondapur (V), Ghatkesar (M), Medchal-Malkajgiri (D)-501301  
Telangana State



*Handwritten signature: Anitha*  
PRINCIPAL  
Vignans Institute of Management & Technology For Women  
Kondapur (V), Ghatkesar (M), Medchal-Malkajgiri (D)-501301  
Telangana State

**Principal**

PRINCIPAL  
Vignans Institute of Management & Technology For Women  
Kondapur (V), Ghatkesar (M), Medchal-Malkajgiri (D)-501301  
Telangana State





# VIGNAN'S INSTITUTE OF MANAGEMENT AND TECHNOLOGY FOR WOMEN

(Approved by AICTE, New Delhi & Affiliated to JNTUH, Hyderabad.)

Kondapur (V), Ghatkesar (M), Medchal - Malkajgiri (D) - 501 301

## CERTIFICATE OF PARTICIPATION

This is to certify that Mr./Ms./Mrs. Prasad Gauthi

of BSH, Vignans Institute of Management and Technology for Women

has participated in One-Day Workshop on "OUTCOME BASED EDUCATION" held on

18-05-2019, Organized by IQAC, Vignans Institute of Management and Technology

for Women.

**Co-ordinator, IQAC**

Co-ordinator

Internal Quality Assurance Cell

Vignans Institute of Management & Technology For Women

Kondapur (V), Ghatkesar (M), Medchal-Habibnagar (D)-501301

Telangana State

PRINCIPAL  
Vignans Institute of Management & Technology For Women  
Kondapur(V), Ghatkesar(M), Medchal-Habibnagar(D)-501301  
Telangana State



**Principal**

PRINCIPAL  
Vignans Institute of Management & Technology For Women  
Kondapur(V), Ghatkesar(M), Medchal-Habibnagar(D)-501301  
Telangana State



# VIGNAN'S INSTITUTE OF MANAGEMENT AND TECHNOLOGY FOR WOMEN

(Approved by AICTE, New Delhi & Affiliated to JNTUH, Hyderabad.)

Kondapur (V), Ghatkesar (M), Medchal - Malkajgiri (D) - 501 301

## CERTIFICATE OF PARTICIPATION

This is to certify that Mr./Ms./Mrs. Shrutha Kondakuri

of BSH, Vignan's Institute of Management and Technology For Women

has participated in One-Day Workshop on "OUTCOME BASED EDUCATION" held on

18-05-2019, Organized by IQAC, Vignan's Institute of Management and Technology

for Women.

**Co-ordinator, IQAC**

Co-ordinator

Internal Quality Assurance Cell

Vignan's Institute of Management & Technology For Women

Kondapur (M), Ghatkesar (M), Medchal-Malkajgiri (D)-501301

Telangana State



**Principal**

Principal

Vignan's Institute of Management & Technology For Women

Kondapur (M), Ghatkesar (M), Medchal-Malkajgiri (D)-501301

Telangana State



# VIGNAN'S INSTITUTE OF MANAGEMENT AND TECHNOLOGY FOR WOMEN

(Approved by AICTE, New Delhi & Affiliated to JNTUH, Hyderabad.)

Kondapur (V), Ghatkesar (M), Medchal - Malkajgiri (D) - 501 301

## CERTIFICATE OF PARTICIPATION

This is to certify that Mr./Ms./Mrs. Co. Pradeep

of BSH, Vignans Institute of Management and Technology for Women

has participated in One-Day Workshop on "OUTCOME BASED EDUCATION" held on

18-05-2019, Organized by IQAC, Vignans Institute of Management and Technology

for Women.

**Co-ordinator, IQAC**  
Co-ordinator

Internal Quality Assurance Cell  
Vignans Institute of Management & Technology For Women  
Kondapur (V), Ghatkesar (M), Medchal-Malkajgiri (D)-501301  
Telangana State



PRINCIPAL

Principal

PRINCIPAL

Vignans Institute of Management & Technology For Women  
Kondapur (V), Ghatkesar (M), Medchal - Malkajgiri (D)-501301  
Telangana State



# VIGNAN'S INSTITUTE OF MANAGEMENT AND TECHNOLOGY FOR WOMEN

(Approved by AICTE, New Delhi & Affiliated to JNTUH, Hyderabad.)

Kondapur (V), Ghatkesar (M), Medchal - Malkajgiri (D) - 501 301

## CERTIFICATE OF PARTICIPATION

This is to certify that Mr./Ms./Mrs. Suzunshalini Varma  
of BSH, Vignans Institute of Management and Technology for Women  
has participated in One-Day Workshop on "OUTCOME-BASED EDUCATION" held on  
18-05-2019, Organized by IQAC, Vignans Institute of Management and Technology  
for Women.

**Co-ordinator, IQAC**

Internal Quality Assurance Cell  
Vignans Institute of Management & Technology For Women  
Kondapur (V), Ghatkesar (M), Medchal-Malkajgiri (D)-501301  
Telangana State



PRINCIPAL  
Vignans Institute of Management & Technology for Women  
Kondapur (V), Ghatkesar (M), Medchal-Malkajgiri (D)-501301  
Telangana State

Principal

PRINCIPAL

Vignans Institute of Management & Technology for Women  
Kondapur (V), Ghatkesar (M), Medchal-Malkajgiri (D)-501301  
Telangana State



# VIGNAN'S INSTITUTE OF MANAGEMENT AND TECHNOLOGY FOR WOMEN

(Approved by AICTE, New Delhi & Affiliated to JNTUH, Hyderabad.)

Kondapur (V), Ghatkesar (M), Medchal - Malkajgiri (D) - 501 301

## CERTIFICATE OF PARTICIPATION

This is to certify that Mr./Ms./Mrs. Venkatesham Boora

of B.S.H. Vignana's Institute of Management & Technology for Women

has participated in One-Day Workshop on "OUTCOME BASED EDUCATION" held on

18-05-2019, Organized by IQAC, Vignana's Institute of Management and Technology

for Women.

*[Signature]*

**Co-ordinator, IQAC**

Co-ordinator  
Internal Quality Assurance Cell  
Vignana's Institute of Management & Technology For Women  
Kondapur (V), Ghatkesar (M), Medchal-Malkajgiri (D)-501301  
Telangana State



*[Signature]*

PRINCIPAL  
Vignana's Institute of Management & Technology For Women  
Kondapur (V), Ghatkesar (M), Medchal-Malkajgiri (D)-501301  
Telangana State

*[Signature]*

Principal

PRINCIPAL  
Vignana's Institute of Management & Technology For Women  
Kondapur (V), Ghatkesar (M), Medchal-Malkajgiri (D)-501301  
Telangana State



# VIGNAN'S INSTITUTE OF MANAGEMENT AND TECHNOLOGY FOR WOMEN

(Sponsored by Lavu Educational Society)

Approved by AICTE, New Delhi & Affiliated to JNTUH, Hyderabad.

Kondapur (V), Ghatkesar (M), Medchal - Malkajgiri (D) - 501 301



## INTERNAL QUALITY ASSURANCE CELL (IQAC)

ORGANISING

# ONE-DAY FACULTY DEVELOPMENT PROGRAM ON QUALITY RESEARCH

28<sup>TH</sup> JULY, 2020 @ 11 AM

VENUE: SEMINAR HALL



Resource Person:

**Dr. Manoranjan Dash,**  
Associate Professor,  
ICFAI, Raipur, Chhattisgarh.



**Chief Patron:**

**Dr. Lavu Rathalah,**  
Chairman, Vignan Group.

**Patron:**

**Mr. S. Shraavan,**  
CEO, Vignan Group.

**Co-Patron:**

**Dr. G. Apparao Naidu,**  
Principal, VMTW.

**Advisor:**

**Mr. P. Harikrishna,**  
Co-Ordinator, IQAC.

**Program Co-Ordinator:**

**Mr. J. Sunil Kumar,**  
Assistant Professor, ECE,  
Cell: +91 83747 17668



PRINCIPAL

Vignans Institute of Management & Technology For Women  
Kondapur (V), Ghatkesar (M), Medchal-Malkajgiri (D)-501301  
Telangana State

Date:24/07/2020

To  
The Principal,  
VMTW,  
Kondapur,  
Ghatkesar

Subject:Approval to Conduct a Seminar on Quality Research Publication Req-Reg:-

Respected Sir,

On behalf of the Internal Quality Assurance Cell (IQAC) of our institution, I am writing to request your support and approval for organizing a Seminar on the topic of "Quality Research Publications," on 28/07/2020

Thank you for considering our request. We look forward to your favourable response.

Yours Faithfully



P.Harikrishna

IQAC-Co-ordinator

Approved  
24/7/20  
24/7/20



PRINCIPAL

Vignans Institute of Management & Technology For Women  
Kondapur (V), Ghatkesar (N), Medchal-Malkajgiri (DI)-501301,  
Telangana State

**Mr. Manoranjan Dash**  
**Assoc, Professor**  
**ICFAI UNIVERSITY, RAIPUR**  
**Mobile: 7566625525**



Mr. Manoranjan Dash received a Bachelor of Technology in Electronics and Tele-Communication Engineering from Biju Patnaik University of Technology, Rourkela in 2009, and Master of Technology in Communication System from Veer Surendra Sai University of Technology, Burla in 2013.

**Teaching Interests**

Signals and Systems  
Digital Signal Processing  
Image Processing  
Machine Learning  
Communication System

**Research Interests**

Signal Processing  
Biomedical Image Processing  
Machine Learning  
Optimization

**PUBLICATIONS**

1. Manoranjan Dash, N.D. Londhe, S. Ghosh, et al., PsLSNet: Automated psoriasis skin lesion segmentation using modified U-Net-based fully convolutional network, Biomed. Signal Process. Control. 52 (2019) 226–237.
2. R. Shrivastava & J. Kaur Manoranjan Dash, "Studies on the Near White Light Emission of SrSiO<sub>3</sub> Doped with Dy<sup>3+</sup> Phosphors", Luminescence, Elsevier Science, vol.34, pp.109-121, May 2014.
3. S. K. Sarangi, R. Panda & Manoranjan Dash, "Design of 1-D and 2-D recursive filters using crossover bacterial foraging and cuckoo search techniques", Engineering Applications of Artificial Intelligence, Elsevier Science, vol.34, pp.109-121, May 2014.
4. Manoranjan Dash, Design of Finite Impulse Response Filters Using Evolutionary Techniques – An Efficient Computation, ICTACT Journal on Communication Technology, March 2020, Volume: 11, Issue: 01
5. R. Shrivastava, Manoranjan Dash, "Studies on photoluminescence properties of Sr<sub>2</sub>MgSi<sub>2</sub>O<sub>7</sub> doped with Dy<sup>3+</sup>", Chemistry Journal, American Institute of science, 2018.
6. Manoranjan Dash presented a conference paper on "Estimation of signal corruption by FIR based adaptive noise canceller using different algorithm", in the International Conference held at Durg, Science College, Chhattisgarh, on 16th January, 2016.
7. Manoranjan Dash presented a conference paper on "Studies on photoluminescence properties of Sr<sub>2</sub>MgSi<sub>2</sub>O<sub>7</sub> doped with Dy<sup>3+</sup>", in the National seminar on challenges & trends in electronics & communication engineering held at SIET, Denkanal, Odisha on 7th February, 2015.
8. Manoranjan Dash presented a conference paper on "Design of Recursive Filters using Genetic Algorithm", in the National Seminar 'ETSP-2013' held at SIET, Denkanal on APRIL 13, 2013.



PRINCIPAL

Women's Institute of Management & Technology For Women  
Kondapur (V), Ghatkesar (M), Medchal-Malkajgiri (DI)-501301  
Telangana State





Date:28/07/2020

## Seminar On Quality Research Publications

This Seminar was addressed by Mr.Manoranjan Dash, who has extensive expertise in research publication and has made significant contributions to his field. The program was attended by faculty members from various departments within our institution.



These sessions covered a wide range of topics related to quality research publication, including:

- Identifying appropriate journals and conferences for publication.
- Enhancing research writing skills, including clarity, structure, and language.
- Ensuring ethical practices and avoiding plagiarism in research publications.
- Navigating the peer review process and effectively responding to reviewer comments.
- Promoting interdisciplinary research collaborations for enhanced publication opportunities.
- Increasing research visibility and impact through effective dissemination strategies.
- Exploring funding opportunities and grants for research publication.



  
PRINCIPAL

Vignans Institute of Management & Technology For Women  
Kondapur (V), Ghatkesar (M), Medchal-Malkajgiri (D)-501301  
Telangana State



The sessions were highly interactive, allowing participants to engage in discussions, ask questions, and share their experiences and challenges related to research publication.

The feedback from the participants was positive. They expressed their gratitude for the opportunity to attend such a beneficial and informative program. Many participants mentioned that they gained valuable insights into the research publication process and felt more confident in their ability to produce high-quality research papers.

## LEARNING OUTCOMES

1. Understanding the importance of quality research publications.
2. Enhancing research methodology skills.
3. Developing academic writing skills.
4. Understanding the publication process.
5. Learning about ethical considerations.
6. Exploring publication strategies and outlets.
7. Overcoming challenges and improving publication success.

In conclusion, the Quality Research Publication Faculty Development Program was a success. A Total of 50 faculty members from various departments participated in FDP. It provided our faculty members with valuable insights, practical skills, and the motivation to enhance the quality and impact of their research publications. We are confident that the knowledge gained from this FDP will positively influence the research culture at our institution and contribute to its academic growth.



*[Signature]*  
PRINCIPAL

Vignans Institute of Management & Technology For Women  
Kondapur (V), Ghatkesar (M), Medchal-Malkajgiri (D) 501301  
Telangana State



# VIGNAN'S INSTITUTE OF MANAGEMENT AND TECHNOLOGY FOR WOMEN

(Sponsored by Lavu Educational Society)  
Approved by AICTE, New Delhi & Affiliated to JNTUH, Hyderabad.

Kondapur (V), Ghatkesar (M), Medchal - Malkajgiri (D) - 501 301



## Certificate of Participation

This is to certify that Mr./Ms./Mrs. Kiran Kumar Lanka  
of EEE, Vignans Institute of Management & Technology for Women  
has participated in a Seminar on "Quality Research Publications" held on 28-07-2020, Organized  
by IQAC, Vignans Institute of Management and Technology for Women.

  
Co-ordinator  
Internal Quality Assurance Cell  
For Women  
Vignans Institute of Management & Technology (VIGNAN)  
Kondapur (V), Ghatkesar (M), Medchal-Malkajgiri (D) - 501 301  
Telangana State



  
PRINCIPAL  
Vignans Institute of Management & Technology For Women  
Kondapur (V), Ghatkesar (M), Medchal-Malkajgiri (D) - 501 301  
Telangana State

  
PRINCIPAL  
Vignans Institute of Management & Technology For Women  
Kondapur (V), Ghatkesar (M), Medchal-Malkajgiri (D) - 501 301  
Telangana State



# VIGNAN'S INSTITUTE OF MANAGEMENT AND TECHNOLOGY FOR WOMEN

(Sponsored by Lavu Educational Society)  
Approved by AICTE, New Delhi & Affiliated to JNTUH, Hyderabad.

Kondapur (V), Ghatkesar (M), Medchal - Malkajgiri (D) - 501 301



## Certificate of Participation

This is to certify that Mr./Ms./Mrs. V. Sudheer Kumar  
of EEE, Vignans Institute of Management & Technology for Women  
has participated in a Seminar on "Quality Research Publications" held on 28-07-2020, Organized  
by IQAC, Vignans Institute of Management and Technology for Women.

  
Co-ordinator  
Internal Quality Assurance Cell  
For Women  
Vignans Institute of Management & Technology For Women  
Kondapur (V), Ghatkesar (M), Medchal-Malkajgiri (D) - 501301  
Telangana State



  
PRINCIPAL  
Vignans Institute of Management & Technology For Women  
Kondapur (V), Ghatkesar (M), Medchal-Malkajgiri (D) - 501301  
Telangana State

  
PRINCIPAL  
Vignans Institute of Management & Technology For Women  
Kondapur (V), Ghatkesar (M), Medchal-Malkajgiri (D) - 501301  
Telangana State



# VIGNAN'S INSTITUTE OF MANAGEMENT AND TECHNOLOGY FOR WOMEN

(Sponsored by Lavu Educational Society)

Approved by AICTE, New Delhi & Affiliated to JNTUH, Hyderabad.

Kondapur (V), Ghatkesar (M), Medchal - Malkajgiri (D) - 501 301

Accredited By



## Certificate of Participation

This is to certify that Mr./Ms./Mrs. Rambabu Thatikayala

of EEE, Vignans Institute of Management & Technology for Women  
has participated in a Seminar on "Quality Research Publications" held on 28-07-2020, Organized  
by IQAC, Vignans Institute of Management and Technology for Women.



[Signature]  
Co-ordinator  
Internal Quality Cell  
Vignans Institute of Management & Technology for Women  
Kondapur (V), Ghatkesar (M), Medchal - Malkajgiri (D) - 501301  
Telangana State

[Signature]  
PRINCIPAL

Vignans Institute of Management & Technology For Women  
Kondapur (V), Ghatkesar (M), Medchal-Malkajgiri (D) - 501301  
Telangana State

[Signature]  
PRINCIPAL  
Vignans Institute of Management & Technology For Women  
Kondapur (V), Ghatkesar (M), Medchal-Malkajgiri (D) - 501301  
Telangana State



# VIGNAN'S INSTITUTE OF MANAGEMENT AND TECHNOLOGY FOR WOMEN

(Sponsored by Lavu Educational Society)

Approved by AICTE, New Delhi & Affiliated to JNTUH, Hyderabad.

Kondapur (V), Ghatkesar (M), Medchal - Malkajgiri (D) - 501 301

Accredited By



NATIONAL BOARD OF ACCREDITATION

CSE & EC

## Certificate of Participation

This is to certify that Mr./Ms./Mrs. Dr. S. Graya  
of ECE, Vignans Institute of Management & Technology for Women  
has participated in a Seminar on "Quality Research Publications" held on 28-07-2020, Organized  
by IQAC, Vignans Institute of Management and Technology for Women.



  
Co-ordinator  
Internal Quality Assurance Cell  
Vignans Institute of Management & Technology for Women  
Kondapur (V), Ghatkesar (M), Medchal-Malkajgiri (D) - 501 301  
Telangana State

  
PRINCIPAL  
Vignans Institute of Management & Technology For Women  
Kondapur (V), Ghatkesar (M), Medchal-Malkajgiri (D) - 501 301  
Telangana State

  
PRINCIPAL  
Vignans Institute of Management & Technology For Women  
Kondapur (V), Ghatkesar (M), Medchal-Malkajgiri (D) - 501 301  
Telangana State



# VIGNAN'S INSTITUTE OF MANAGEMENT AND TECHNOLOGY FOR WOMEN

(Sponsored by Lavu Educational Society)

Approved by AICTE, New Delhi & Affiliated to JNTUH, Hyderabad.

Kondapur (M), Ghatkesar (M), Medchal - Malkajgiri (D) - 501 301

Accredited By



## Certificate of Participation

This is to certify that Mr./Ms./Mrs. Dr. Samiran Chatterjee

of ECE, Vignans Institute of management & Technology for women  
has participated in a Seminar on "Quality Research Publications" held on 28-07-2020, Organized  
by IQAC, Vignans' Institute of Management and Technology for Women.

*Signature*

Co-ordinator  
Internal Quality Assurance Cell  
Vignans Institute of Management & Technology For Women  
Kondapur (M), Medchal-Malkajgiri (D)-501301  
Telangana State



*Signature*

PRINCIPAL  
Vignans Institute of Management & Technology For Women  
Kondapur (M), Ghatkesar (M), Medchal-Malkajgiri (D)-501301  
Telangana State

*Signature*

PRINCIPAL  
Vignans Institute of Management & Technology For Women  
Kondapur (M), Ghatkesar (M), Medchal-Malkajgiri (D)-501301  
Telangana State



# VIGNAN'S INSTITUTE OF MANAGEMENT AND TECHNOLOGY FOR WOMEN

(Sponsored by Lavu Educational Society)

Approved by AICTE, New Delhi & Affiliated to JNTUH, Hyderabad.

Kondapur (V), Ghatkesar (M), Medchal - Malkajgiri (D) - 501 301

Accredited By



## Certificate of Participation

This is to certify that Mr./Mrs. Mr. Sunilkumar Jangili  
of ECE, Vignans Institute of Management & Technology for Women  
has participated in a Seminar on "Quality Research Publications" held on 28-07-2020, Organized  
by IQAC, Vignans Institute of Management and Technology for Women.

*[Handwritten Signature]*

Co-ordinator  
Internal Quality Assurance Cell  
Vignans Institute of Management & Technology for Women  
Kondapur (V), Ghatkesar (M), Medchal-Malkajgiri (D) - 501301



*[Handwritten Signature]*  
PRINCIPAL

Vignans Institute of Management & Technology For Women  
Kondapur (V), Ghatkesar (M), Medchal-Malkajgiri (D) - 501301  
Telangana State

*[Handwritten Signature]*  
PRINCIPAL

Vignans Institute of Management & Technology For Women  
Kondapur (V), Ghatkesar (M), Medchal-Malkajgiri (D) - 501301  
Telangana State





# VIGNAN'S INSTITUTE OF MANAGEMENT AND TECHNOLOGY FOR WOMEN

(Sponsored by Lavu Educational Society)

Approved by AICTE, New Delhi & Affiliated to JNTUH, Hyderabad.

Kondapur (V), Ghatkesar (M), Medchal - Malkajgiri (D) - 501 301

Accredited By



## Certificate of Participation

This is to certify that <sup>✓</sup>Mr./Ms./Mrs. T. Pullaiah

of ECE, Vignans Institute of Management & Technology for Women  
has participated in a Seminar on "Quality Research Publications" held on 28-07-2020, Organized  
by IQAC, Vignans Institute of Management and Technology for Women.



*VP*

Co-ordinator  
IQAC  
Vignans Institute of Management & Technology for Women  
Kondapur (V), Ghatkesar (M), Medchal - Malkajgiri (D) - 501301  
Telangana State

*VP*

Principal  
Vignans Institute of Management & Technology For Women  
Kondapur (V), Ghatkesar (M), Medchal-Malkajgiri (D)-501301  
Telangana State

*VP*

Principal  
Vignans Institute of Management & Technology For Women  
Kondapur (V), Ghatkesar (M), Medchal-Malkajgiri (D)-501301  
Telangana State



# VIGNAN'S INSTITUTE OF MANAGEMENT AND TECHNOLOGY FOR WOMEN

(Sponsored by Lavu Educational Society)  
Approved by AICTE, New Delhi & Affiliated to JNTUH, Hyderabad.  
Kondapur (V), Ghatkesar (M), Medchal - Malkajgiri (D) - 501 301



## Certificate of Participation

This is to certify that Mr./Ms./Mrs. Vijay Kumar R Urkude  
of ECE, Vignans Institute of management & Technology for Women  
has participated in a Seminar on "Quality Research Publications" held on 28-07-2020, Organized  
by IQAC, Vignans Institute of Management and Technology for Women.



*Handwritten signature*

*Handwritten signature*  
Co-ordinator  
Internal Quality Assurance Cell  
Vignans Institute of Management & Technology for Women  
Kondapur (V), Medchal-Malkajgiri (D), 501301  
Telangana State

PRINCIPAL  
Vignans Institute of Management & Technology for Women  
Kondapur (V), Ghatkesar (M), Medchal-Malkajgiri (D), 501301  
Telangana State



# VIGNAN'S INSTITUTE OF MANAGEMENT AND TECHNOLOGY FOR WOMEN

(Sponsored by Lavu Educational Society)  
Approved by AICTE, New Delhi & Affiliated to JNTUH, Hyderabad.  
Kondapur (V), Ghatkesar (M), Medchal - Malkajgiri (D) - 501 301



## Certificate of Participation

This is to certify that Mr./Ms./Mrs. Anusha PiniSETTY  
of ECE, Vignan's Institute of management & Technology for women  
has participated in a Seminar on "Quality Research Publications" held on 28-07-2020, Organized  
by IQAC, Vignan's Institute of Management and Technology for Women.



*VP*  
Co-ordinator  
Internal Quality Assurance Cell  
Vignana's Institute of Management & Technology for Women  
Kondapur (V), Ghatkesar (M), Medchal - Malkajgiri (D) - 501 301  
T.S.

*vasu*  
PRINCIPAL

Vignana's Institute of Management & Technology for Women  
Kondapur (V), Ghatkesar (M), Medchal - Malkajgiri (D) - 501 301  
Telangana State

*VP*  
PRINCIPAL  
Vignana's Institute of Management & Technology for Women  
Kondapur (V), Ghatkesar (M), Medchal - Malkajgiri (D) - 501 301  
Telangana State



# VIGNAN'S INSTITUTE OF MANAGEMENT AND TECHNOLOGY FOR WOMEN

(Sponsored by Lavu Educational Society)

Approved by AICTE, New Delhi & Affiliated to JNTUH, Hyderabad.

Kondapur (V), Ghatkesar (M), Medchal - Malkajgiri (D) - 501 301

Accredited By



## Certificate of Participation

This is to certify that Mr./Ms./Mrs. Ashok Reddy Katta  
of ECE, Vignan's Institute of management & Technology for Women  
has participated in a Seminar on "Quality Research Publications" held on 28-07-2020, Organized  
by IQAC, Vignan's Institute of Management and Technology for Women.

  
Co-ordinator

Co-ordinator  
Vignan's Institute of Management & Technology for Women  
Kondapur (V), Ghatkesar (M), Medchal-Malkajgiri (D) - 501301  
Telangana State



  
PRINCIPAL  
Vignan's Institute of Management & Technology For Women  
Kondapur (V), Ghatkesar (M), Medchal-Malkajgiri (D) - 501301  
Telangana State

  
PRINCIPAL  
Vignan's Institute of Management & Technology For Women  
Kondapur (V), Ghatkesar (M), Medchal-Malkajgiri (D) - 501301  
Telangana State



# VIGNAN'S INSTITUTE OF MANAGEMENT AND TECHNOLOGY FOR WOMEN

(Sponsored by Lavu Educational Society)  
Approved by AICTE, New Delhi & Affiliated to JNTUH, Hyderabad.  
Kondapur (V), Ghatkesar (M), Medchal - Malkajgiri (D) - 501 301



## Certificate of Participation

This is to certify that Mr./Ms./Mrs. G. Granesh Reddy  
of ECE, Vignans Institute of management & Technology for Women  
has participated in a Seminar on "Quality Research Publications" held on 28-07-2020, Organized  
by IQAC, Vignans Institute of Management and Technology for Women.



  
Co-ordinator  
Co-ordinating Cell  
Insurance Cell  
Vignans Institute of Management & Technology for Women  
Kondapur (V), Ghatkesar (M), Medchal-Malkajgiri (D) - 501301  
Telangana State

  
PRINCIPAL  
Vignans Institute of Management & Technology For Women  
Kondapur (V), Ghatkesar (M), Medchal-Malkajgiri (D) - 501301  
Telangana State

  
PRINCIPAL  
Vignans Institute of Management & Technology For Women  
Kondapur (V), Ghatkesar (M), Medchal-Malkajgiri (D) - 501301  
Telangana State



# VIGNAN'S INSTITUTE OF MANAGEMENT AND TECHNOLOGY FOR WOMEN

(Sponsored by Lavu Educational Society)  
Approved by AICTE, New Delhi & Affiliated to JNTUH, Hyderabad.

Kondapur (V), Ghatkesar (M), Medchal - Malkajgiri (D) - 501 301



## Certificate of Participation

This is to certify that Mr./Ms./Mrs. Karthik pal Maddikunta  
of ECE, Vignans Institute of management & Technology for women  
has participated in a Seminar on "Quality Research Publications" held on 28-07-2020, Organized  
by IQAC, Vignans Institute of Management and Technology for Women.

  
Co-ordinator  
Co-ordinator for IQAC & Technology For Women  
Institute of Management & Technology (D)-501301  
Kondapur (V), Medchal-Malkajgiri (D)-501301  
Telangana State



  
Principal  
Vignans Institute of Management & Technology For Women  
Kondapur (V), Ghatkesar (M), Medchal-Malkajgiri (D)-501301  
Telangana State

  
Principal  
Vignans Institute of Management & Technology For Women  
Kondapur (V), Ghatkesar (M), Medchal-Malkajgiri (D)-501301  
Telangana State



# VIGNAN'S INSTITUTE OF MANAGEMENT AND TECHNOLOGY FOR WOMEN

(Sponsored by Lavu Educational Society)  
Approved by AICTE, New Delhi & Affiliated to JNTUH, Hyderabad.  
Kondapur (V), Ghatkesar (M), Medchal - Malkajgiri (D) - 501 301



## Certificate of Participation

This is to certify that Mr./Ms./Mrs. Nagaraju Eduru  
of ECE, Vignana's Institute of management & Technology for women  
has participated in a Seminar on "Quality Research Publications" held on 28-07-2020, Organized  
by IQAC, Vignana's Institute of Management and Technology for Women.



NP  
Co-ordinator  
Co-ordinator Cell Women  
Internal Quality Assurance Cell  
Vignana's Institute of Management & Technology for Women  
Kondapur (V), Ghatkesar (M), Medchal-Malkajgiri (D) - 501 301  
Telangana State

NP  
PRINCIPAL  
Vignana's Institute of Management & Technology For Women  
Kondapur (V), Ghatkesar (M), Medchal-Malkajgiri (D) - 501 301  
Telangana State

NP  
PRINCIPAL  
Vignana's Institute of Management & Technology For Women  
Kondapur (V), Ghatkesar (M), Medchal-Malkajgiri (D) - 501 301  
Telangana State



# VIGNAN'S INSTITUTE OF MANAGEMENT AND TECHNOLOGY FOR WOMEN



(Sponsored by Lavu Educational Society)  
Approved by AICTE, New Delhi & Affiliated to JNTUH, Hyderabad.  
Kondapur (V), Ghatkesar (M), Medchal - Malkajgiri (D) - 501 301

## Certificate of Participation

This is to certify that Mr./Mrs. Grangula Swathi  
of ECE, Vignans Institute of management & Technology for Women  
has participated in a Seminar on "Quality Research Publications" held on 28-07-2020, Organized  
by IQAC, Vignans Institute of Management and Technology for Women.



PR  
Co-ordinator  
Internal Quality Assurance Cell  
Vignans Institute of Management & Technology for Women  
Kondapur (V), Ghatkesar (M), Medchal - Malkajgiri (D) - 501 301  
Telangana State

Swathi  
PRINCIPAL  
Vignans Institute of Management & Technology For Women  
Kondapur (V), Ghatkesar (M), Medchal - Malkajgiri (D) - 501 301  
Telangana State

Swathi  
PRINCIPAL  
Vignans Institute of Management & Technology For Women  
Kondapur (V), Ghatkesar (M), Medchal - Malkajgiri (D) - 501 301  
Telangana State





# VIGNAN'S INSTITUTE OF MANAGEMENT AND TECHNOLOGY FOR WOMEN

(Sponsored by Lavu Educational Society)

Approved by AICTE, New Delhi & Affiliated to JNTUH, Hyderabad.

Kondapur (V), Ghatkesar (M), Medchal - Malkajgiri (D) - 501 301

Accredited By



## Certificate of Participation

This is to certify that Mr./Ms./Mrs. Narandra Gali

of ECE, Vignan's Institute of management & Technology for Women  
has participated in a Seminar on "Quality Research Publications" held on 28-07-2020, Organized  
by IQAC, Vignan's Institute of Management and Technology for Women.



  
Co-ordinator  
Internal Quality Assurance Cell  
Vignan's Institute of Management & Technology for Women  
Kondapur (V), Ghatkesar (M), Malkajgiri (D) - 501 301  
Telangana State

  
PRINCIPAL  
Vignan's Institute of Management & Technology for Women  
Kondapur (V), Ghatkesar (M), Medchal-Malkajgiri (D) - 501 301  
Telangana State

  
PRINCIPAL  
Vignan's Institute of Management & Technology for Women  
Kondapur (V), Ghatkesar (M), Medchal-Malkajgiri (D) - 501 301  
Telangana State



# VIGNAN'S INSTITUTE OF MANAGEMENT AND TECHNOLOGY FOR WOMEN



(Sponsored by Lavu Educational Society)  
Approved by AICTE, New Delhi & Affiliated to JNTUH, Hyderabad.  
Kondapur (V), Ghatkesar (M), Medchal - Malkajgiri (D) - 501 301

## Certificate of Participation

This is to certify that Mr./Mrs. Usharani Narasingam  
of ECE, Vignan's Institute of management & Technology for women  
has participated in a Seminar on "Quality Research Publications" held on 28-07-2020, Organized  
by IQAC, Vignan's Institute of Management and Technology for Women.



  
Co-ordinator  
Co-ordinator Cell  
Vignan's Institute of Management & Technology for Women  
Kondapur (V), Ghatkesar (M), Medchal - Malkajgiri (D) - 501301  
TS

  
PRINCIPAL  
Vignan's Institute of Management & Technology For Women  
Kondapur (V), Ghatkesar (M), Medchal-Malkajgiri (D) - 501301  
Telangana State

  
PRINCIPAL  
Vignan's Institute of Management & Technology For Women  
Kondapur (V), Ghatkesar (M), Medchal-Malkajgiri (D) - 501301  
Telangana State



# VIGNAN'S INSTITUTE OF MANAGEMENT AND TECHNOLOGY FOR WOMEN

(Sponsored by Lavu Educational Society)

Approved by AICTE, New Delhi & Affiliated to JNTUH, Hyderabad.

Kondapur (V), Ghatkesar (M), Medchal - Malkajgiri (D) - 501 301

Accredited By



NATIONAL BOARD OF ACCREDITATION

GSE & ECI

## Certificate of Participation

This is to certify that Mr./Ms./Mrs. Hemalatha Maddigatla  
of ECE, Vignana's Institute of management & Technology, for women  
has participated in a Seminar on "Quality Research Publications" held on 28-07-2020, Organized  
by IQAC, Vignana's Institute of Management and Technology for Women.



*Handwritten initials*

Co-ordinator  
Internal Quality Assurance Cell  
Vignana's Institute of Management & Technology For Women  
Kondapur (V), Ghatkesar (M), Medchal-Malkajgiri (D) - 501301  
Telangana State

*Handwritten signature*

Principal  
Vignana's Institute of Management & Technology For Women  
Kondapur (V), Ghatkesar (M), Medchal-Malkajgiri (D) - 501301

*Handwritten signature*

PRINCIPAL  
Vignana's Institute of Management & Technology For Women  
Kondapur (V), Ghatkesar (M), Medchal-Malkajgiri (D) - 501301  
Telangana State



# VIGNAN'S INSTITUTE OF MANAGEMENT AND TECHNOLOGY FOR WOMEN

(Sponsored by Lavu Educational Society)  
Approved by AICTE, New Delhi & Affiliated to JNTUH, Hyderabad.

Kondapur (V), Ghatkesar (M), Medchal - Malkajgiri (D) - 501 301



## Certificate of Participation

This is to certify that Mr./Ms./Mrs. Dr. Parimi Srinivasa Rao Sree Venkata  
of CSE, Vignans Institute of management & Technology for Women  
has participated in a Seminar on "Quality Research Publications" held on 28-07-2020, Organized  
by IQAC, Vignans Institute of Management and Technology for Women.



*Handwritten signature*  
PRINCIPAL

Vignans Institute of Management & Technology For Women  
Kondapur (M), Ghatkesar (M), Medchal-Malkajgiri (D)-501301  
Telangana State

*Handwritten signature*  
Coordinator

Internal Quality Assurance Cell  
Vignans Institute of Management & Technology For Women  
Kondapur (M), Ghatkesar (M), Medchal-Malkajgiri (D)-501301  
Telangana State

*Handwritten signature*  
PRINCIPAL  
Vignans Institute of Management & Technology  
Kondapur (M), Ghatkesar (M), Medchal-Malkajgiri (D)-501301  
Telangana State



# VIGNAN'S INSTITUTE OF MANAGEMENT AND TECHNOLOGY FOR WOMEN

(Sponsored by Lavu Educational Society)

Approved by AICTE, New Delhi & Affiliated to JNTUH, Hyderabad.

Kondapur (V), Ghatkesar (M), Medchal - Malkajgiri (D) - 501 301

Accredited By



## Certificate of Participation

This is to certify that Mr./Ms./Mrs. Dr. Tangala Sasi Kiran  
of CSE, Vignans Institute of management & Technology for women,  
has participated in a Seminar on "Quality Research Publications" held on 28-07-2020, Organized  
by IQAC, Vignans Institute of Management and Technology for Women.



*Handwritten signature*

PRINCIPAL  
Vignans Institute of Management & Technology For Women  
Kondapur (V), Ghatkesar (M), Medchal-Malkajgiri (D)-501301  
Telangana State

*Handwritten signature*

Coordinator  
University Quality Assurance Cell  
Vignans Institute of Management & Technology For Women  
Kondapur (V), Ghatkesar (M), Medchal-Malkajgiri (D)-501301  
Telangana State

PRINCIPAL  
Vignans Institute of Management & Technology For Women  
Kondapur (V), Ghatkesar (M), Medchal-Malkajgiri (D)-501301  
Telangana State



# VIGNAN'S INSTITUTE OF MANAGEMENT AND TECHNOLOGY FOR WOMEN

(Sponsored by Lavu Educational Society)

Approved by AICTE, New Delhi & Affiliated to JNTUH, Hyderabad.

Kondapur (V), Ghatkesar (M), Medchal - Malkajgiri (D) - 501 301



## Certificate of Participation

This is to certify that Mr./Ms./Mrs. Dr.S. Ranga Swamy  
of CSE, Vignans Institute of management & Techrdogy for women  
has participated in a Seminar on "Quality Research Publications" held on 28-07-2020, Organized  
by IQAC, Vignans Institute of Management and Technology for Women.

  
Coordinator  
Quality Assurance Cell  
Vignans Institute of Management & Technology For Women  
Kondapur (V), Ghatkesar (M), Medchal-Malkajgiri (D)-501301



  
PRINCIPAL  
Vignans Institute of Management & Technology For Women  
Kondapur (V), Ghatkesar (M), Medchal-Malkajgiri (D)-501301  
Telangana State

  
PRINCIPAL  
Vignans Institute of Management & Technology For Women  
Kondapur (V), Ghatkesar (M), Medchal-Malkajgiri (D)-501301  
Telangana State



# VIGNAN'S INSTITUTE OF MANAGEMENT AND TECHNOLOGY FOR WOMEN

(Sponsored by Lavu Educational Society)

Approved by AICTE, New Delhi & Affiliated to JNTUH, Hyderabad.

Kondapur (V), Ghatkesar (M), Medchal - Malkajgiri (D) - 501 301



## Certificate of Participation

This is to certify that Mr./Mrs. Rajendra Prasad Paraganti  
of CSE, Vignana's Institute of management & Technology for Women  
has participated in a Seminar on "Quality Research Publications" held on 28-07-2020, Organized  
by IQAC, Vignana's Institute of Management and Technology for Women.

Coordinator  
Cell  
Vignana's Institute of Management & Technology For Women  
Kondapur (V), Ghatkesar (M), Medchal-Malkajgiri (D)-501301  
Telangana State



*Handwritten signature in green ink*

PRINCIPAL

Vignana's Institute of Management & Technology For Women  
Kondapur (V), Ghatkesar (M), Medchal-Malkajgiri (D)-501301  
Telangana State

*Handwritten signature in black ink*  
Principal  
Vignana's Institute of Management & Technology For Women  
Kondapur (V), Ghatkesar (M), Medchal-Malkajgiri (D)-501301  
Telangana State



# VIGNAN'S INSTITUTE OF MANAGEMENT AND TECHNOLOGY FOR WOMEN

(Sponsored by Lavu Educational Society)

Approved by AICTE, New Delhi & Affiliated to JNTUH, Hyderabad.

Kondapur (V), Ghatkesar (M), Medchal - Malkajgiri (D) - 501 301

Accredited By



## Certificate of Participation

This is to certify that Mr./Ms./Mrs. Indrani Vasireddy  
of CSE, Vignan's Institute of Management & Technology for Women  
has participated in a Seminar on "Quality Research Publications" held on 28-07-2020, Organized  
by IQAC, Vignan's Institute of Management and Technology for Women.

  
Coordinator  
Internal Quality Assurance Cell  
Vignan's Institute of Management & Technology for Women  
Kondapur (V), Ghatkesar (M), Medchal-Malkajgiri (D)-501301  
Telangana State



  
PRINCIPAL

Vignan's Institute of Management & Technology For Women  
Kondapur (V), Ghatkesar (M), Medchal-Malkajgiri (D)-501301  
Telangana State

  
PRINCIPAL  
Vignan's Institute of Management & Technology For Women  
Kondapur (V), Ghatkesar (M), Medchal-Malkajgiri (D)-501301  
Telangana State





# VIGNAN'S INSTITUTE OF MANAGEMENT AND TECHNOLOGY FOR WOMEN

(Sponsored by Lavu Educational Society)

Approved by AICTE, New Delhi & Affiliated to JNTUH, Hyderabad.

Kondapur (M), Ghatkesar (M), Medchal - Malkajgiri (D) - 501 301



## Certificate of Participation

✓ This is to certify that Mr./Ms./Mrs. Vishnu Vardhana Rao Moram  
of CSE, Vignans Institute of management & Technology for Women  
has participated in a Seminar on "Quality Research Publications" held on 28-07-2020, Organized  
by IQAC, Vignans Institute of Management and Technology for Women.



Co-ordinator  
Quality Assurance Cell  
Vignans Institute of Management & Technology For Women  
Kondapur (M), Ghatkesar (M), Medchal-Malkajgiri (D)-501301  
Telangana State

*VASH*  
PRINCIPAL

Women's Institute of Management & Technology For Women  
Kondapur (M), Ghatkesar (M), Medchal-Malkajgiri (D)-501301  
Telangana State

*VASH*  
PRINCIPAL  
Women's Institute of Management & Technology For Women  
Kondapur (M), Ghatkesar (M), Medchal-Malkajgiri (D)-501301  
Telangana State



# VIGNAN'S INSTITUTE OF MANAGEMENT AND TECHNOLOGY FOR WOMEN



(Sponsored by Lavu Educational Society)

Approved by AICTE, New Delhi & Affiliated to JNTUH, Hyderabad.

Kondapur (M), Ghatkesar (M), Medchal - Malkajgiri (D) - 501 301

## Certificate of Participation

This is to certify that Mr./Ms./Mrs. Ravi Surarapu

of CSE, Vignans Institute of management & Technology for Women  
has participated in a Seminar on "Quality Research Publications" held on 28-07-2020, Organized  
by IQAC, Vignans Institute of Management and Technology for Women.



  
Co-ordinator

Internal Quality Assurance Cell  
Vignans Institute of Management & Technology for Women  
Kondapur (M), Ghatkesar (M), Medchal - Malkajgiri (D) - 501 301

  
PRINCIPAL

Vignans Institute of Management & Technology For Women  
Kondapur (M), Ghatkesar (M), Medchal-Malkajgiri (D) - 501 301  
Telangana State

  
PRINCIPAL  
Vignans Institute of Management & Technology For Women  
Kondapur (M), Ghatkesar (M), Medchal-Malkajgiri (D) - 501 301  
Telangana State



# VIGNAN'S INSTITUTE OF MANAGEMENT AND TECHNOLOGY FOR WOMEN

Accredited By



(Sponsored by Lavu Educational Society)

Approved by AICTE, New Delhi & Affiliated to JNTUH, Hyderabad.

Kondapur (V), Ghatkesar (M), Medchal - Malkajgiri (D) - 501 301

## Certificate of Participation

This is to certify that Mr./Ms./Mrs. Bhavani Greetha  
of CSE, Vignans Institute of management & Technology for women  
has participated in a Seminar on "Quality Research Publications" held on 28-07-2020, Organized  
by IQAC, Vignans' Institute of Management and Technology for Women.



Coordinator  
Internal Quality Assurance Cell  
**VIGNANS IQAC** For Women  
Vignans Institute of Management & Technology for Women  
Kondapur (V), Ghatkesar (M), Medchal - Malkajgiri (D) - 501301  
Telangana State

*Handwritten signature*  
PRINCIPAL

Vignans Institute of Management & Technology For Women  
Kondapur (V), Ghatkesar (M), Medchal-Malkajgiri (D)-501301  
Telangana State

*Handwritten signature*  
PRINCIPAL  
Vignans Institute of Management & Technology For Women  
Kondapur (V), Ghatkesar (M), Medchal-Malkajgiri (D)-501301  
Telangana State



# VIGNAN'S INSTITUTE OF MANAGEMENT AND TECHNOLOGY FOR WOMEN

(Sponsored by Lavu Educational Society)

Approved by AICTE, New Delhi & Affiliated to JNTUH, Hyderabad.

Kondapur (V), Ghatkesar (M), Medchal - Malkajgiri (D) - 501 301



## Certificate of Participation

This is to certify that *Mr./Ms./Mrs. Ch. Sunil*

*of CSE, Vignans Institute of management & Technology for women*  
*has participated in a Seminar on "Quality Research Publications" held on 28-07-2020, Organized*  
*by IQAC, Vignans Institute of Management and Technology for Women.*

*CF* Coordinator  
Internal Quality Assurance Cell  
Vignans Institute of Management & Technology For Women  
Kondapur (V), Ghatkesar (M), Medchal-Malkajgiri (D) - 501301  
Telangana State



*nan*  
PRINCIPAL

Vignans Institute of Management & Technology For Women  
Kondapur (V), Ghatkesar (M), Medchal-Malkajgiri (D) - 501301

*nan*  
PRINCIPAL  
Vignans Institute of Management & Technology For Women  
Kondapur (V), Ghatkesar (M), Medchal-Malkajgiri (D) - 501301  
Telangana State



# VIGNAN'S INSTITUTE OF MANAGEMENT AND TECHNOLOGY FOR WOMEN

(Sponsored by Lavu Educational Society)

Approved by AICTE, New Delhi & Affiliated to JNTUH, Hyderabad.

Kondapur (V), Ghatkesar (M), Medchal - Malkajgiri (D) - 501 301

Accredited By



## Certificate of Participation

This is to certify that Mr./Ms./Mrs. Venukumar Nagu

of CSE, Vignan's Institute of management & Technology for women  
has participated in a Seminar on "Quality Research Publications" held on 28-07-2020, Organized  
by IQAC, Vignan's Institute of Management and Technology for Women.

  
Coordinator

Quality Assurance Cell  
**Vignan's Institute of Management & Technology For Women**  
Kondapur (V), Ghatkesar (M), Medchal-Malkajgiri (D) - 501301





PRINCIPAL

Vignan's Institute of Management & Technology For Women  
Kondapur (V), Ghatkesar (M), Medchal-Malkajgiri (D)

Telangana State

  
PRINCIPAL  
Vignan's Institute of Management & Technology For Women  
Kondapur (V), Ghatkesar (M), Medchal-Malkajgiri (D)



# VIGNAN'S INSTITUTE OF MANAGEMENT AND TECHNOLOGY FOR WOMEN

(Sponsored by Lavu Educational Society)

Approved by AICTE, New Delhi & Affiliated to JNTUH, Hyderabad.

Kondapur (M), Ghatkesar (M), Medchal - Malkajgiri (D) - 501 301

Accredited By



## Certificate of Participation

This is to certify that Mr./Ms./Mrs. S. Sandeep Babu

of CSE, Vignans Institute of Management & Technology for women  
has participated in a Seminar on "Quality Research Publications" held on 28-07-2020, Organized  
by IQAC, Vignans Institute of Management and Technology for Women.



Co-ordinator  
Quality Assurance Cell  
Vignans Institute of Management & Technology For Women  
Kondapur (M), Ghatkesar (M), Medchal-Malkajgiri (D)-501301  
Telangana State

*Handwritten signature*

Principal

Vignans Institute of Management & Technology For Women

Kondapur (M), Ghatkesar (M), Medchal-Malkajgiri (D)-501301  
Telangana State

Principal  
Vignans Institute of Management & Technology For Women  
Kondapur (M), Ghatkesar (M), Medchal-Malkajgiri (D)-501301  
Telangana State



# VIGNAN'S INSTITUTE OF MANAGEMENT AND TECHNOLOGY FOR WOMEN

(Sponsored by Lavu Educational Society)

Approved by AICTE, New Delhi & Affiliated to JNTUH, Hyderabad.

Kondapur (V), Ghatkesar (M), Medchal - Malkajgiri (D) - 501 301

Accredited By



## Certificate of Participation

This is to certify that Mr./Ms./Mrs. Sathini Santhosh Kumar  
of CSE, Vignans Institute of management & Technology for Women  
has participated in a Seminar on "Quality Research Publications" held on 28-07-2020, Organized  
by IQAC, Vignans Institute of Management and Technology for Women.



Co-ordinator  
Vignans Institute of Management & Technology For Women  
Kondapur (V), Ghatkesar (M), Medchal-Malkajgiri (D) - 501301

*Santhi*  
PRINCIPAL

Vignans Institute of Management & Technology For Women  
Kondapur (V), Ghatkesar (M), Medchal-Malkajgiri (D) - 501301

PRINCIPAL  
Vignans Institute of Management & Technology For Women  
Kondapur (V), Ghatkesar (M), Medchal-Malkajgiri (D) - 501301  
Telangana State



# VIGNAN'S INSTITUTE OF MANAGEMENT AND TECHNOLOGY FOR WOMEN

(Sponsored by Lavu Educational Society)  
Approved by AICTE, New Delhi & Affiliated to JNTUH, Hyderabad.  
Kondapur (V), Ghatkesar (M), Medchal - Malkajgiri (D) - 501 301



## Certificate of Participation

This is to certify that Mr./Mrs. S. Dilli Babu  
of CSE, Vignan's Institute of management & Technology for con  
has participated in a Seminar on "Quality Research Publications" held on 28-07-2020, Organized  
by IQAC, Vignan's Institute of Management and Technology for Women.



Co-ordinator  
Cybernetic Quality Assurance Cell  
Vignan's Institute of Management & Technology For Women  
Kondapur (V), Ghatkesar (M), Medchal-Malkajgiri (D)-501301  
Telangana State

Principal  
Vignan's Institute of Management & Technology For Women  
Kondapur (V), Ghatkesar (M), Medchal-Malkajgiri (D)-501301  
Telangana State

Principal  
Vignan's Institute of Management & Technology For Women  
Kondapur (V), Ghatkesar (M), Medchal-Malkajgiri (D)-501301  
Telangana State





# VIGNAN'S INSTITUTE OF MANAGEMENT AND TECHNOLOGY FOR WOMEN

(Sponsored by Lavu Educational Society)  
Approved by AICTE, New Delhi & Affiliated to JNTUH, Hyderabad.  
Kondapur (V), Ghatkesar (M), Medchal - Malkajgiri (D) - 501 301



## Certificate of Participation

This is to certify that Mr./Ms./Mrs. Vinay Bhushan Pillalamari  
of CSE, Vignans Institute of management & Technology for women  
has participated in a Seminar on "Quality Research Publications" held on 28-07-2020, Organized  
by IQAC, Vignans Institute of Management and Technology for Women.

*Handwritten signature in green ink.*



*Handwritten signature in black ink.*  
Coordinator  
Quality Assurance Cell  
Vignans Institute of Management & Technology For Women  
Kondapur (V), Ghatkesar (M), Medchal-Malkajgiri (D) - 501301  
Telangana State

Vignans Institute of Management & Technology For Women  
Kondapur (V), Ghatkesar (M), Medchal-Malkajgiri (D), Telangana State

*Handwritten signature in black ink.*  
Principal  
Vignans Institute of Management & Technology For Women  
Kondapur (V), Ghatkesar (M), Medchal-Malkajgiri (D), Telangana State



# VIGNAN'S INSTITUTE OF MANAGEMENT AND TECHNOLOGY FOR WOMEN

(Sponsored by Lavu Educational Society)

Approved by AICTE, New Delhi & Affiliated to JNTUH, Hyderabad.

Kondapur (V), Ghatkesar (M), Medchal - Malkajgiri (D) - 501 301

Accredited By



## Certificate of Participation

This is to certify that Mr./Mrs. Linga murthy Endla

of CSE, Vignans Institute of management & Technology for women  
has participated in a Seminar on "Quality Research Publications" held on 28-07-2020, Organized  
by IQAC, Vignans Institute of Management and Technology for Women.

  
Co-ordinator  
Internal Quality Assurance Cell  
Vignans Institute of Management & Technology For Women  
Kondapur (M), Ghatkesar (M), Medchal-Malkajgiri (D)-501301  
Telangana State





Principal

Vignans Institute of Management & Technology For Women  
Kondapur (M), Ghatkesar (M), Medchal-Malkajgiri (D), State

Telangana State

Principal

Vignans Institute of Management & Technology For Women  
Kondapur (M), Ghatkesar (M), Medchal-Malkajgiri (D), State  
Telangana State



# VIGNAN'S INSTITUTE OF MANAGEMENT AND TECHNOLOGY FOR WOMEN

(Sponsored by Lavu Educational Society)

Approved by AICTE, New Delhi & Affiliated to JNTUH, Hyderabad.

Kondapur (V), Ghatkesar (M), Medchal - Malkajgiri (D) - 501 301

Accredited By



## Certificate of Participation

This is to certify that <sup>V</sup>Mr./Ms./Mrs. Jagadeeshwar Reddy

of CSE, Vignans Institute of management & Technology for women  
has participated in a Seminar on "Quality Research Publications" held on 28-07-2020, Organized  
by IQAC, Vignans Institute of Management and Technology for Women.



Coordinator  
Quality Assurance Cell  
IQAC For Women  
Vignans Institute of Management & Technology  
Kondapur (V), Ghatkesar (M), Medchal-Malkajgiri (D)-501301  
Telangana State





Principal  
Vignans Institute of Management & Technology For Women  
Kondapur (V), Ghatkesar (M), Medchal-Malkajgiri (D)-501301  
Telangana State

  
Principal  
Vignans Institute of Management & Technology  
Kondapur (V), Ghatkesar (M), Medchal-Malkajgiri (D)-501301  
Telangana State



# VIGNAN'S INSTITUTE OF MANAGEMENT AND TECHNOLOGY FOR WOMEN

(Sponsored by Lavu Educational Society)

Approved by AICTE, New Delhi & Affiliated to JNTUH, Hyderabad.

Kondapur (V), Ghatkesar (M), Medchal - Malkajgiri (D) - 501 301

Accredited By



## Certificate of Participation

This is to certify that Mr./Ms./Mrs. K. Bharath Reddy  
of CSE, Vignans Institute of management & Technology for women  
has participated in a Seminar on "Quality Research Publications" held on 28-07-2020, Organized  
by IQAC, Vignans Institute of Management and Technology for Women.



  
Coordinator  
Quality Assurance Cell  
Vignans Institute of Management & Technology For Women  
Kondapur (V), Ghatkesar (M), Medchal-Malkajgiri (D)-501301  
Telangana State

  
PRINCIPAL  
Vignans Institute of Management & Technology For Women  
Kondapur (V), Ghatkesar (M), Medchal-Malkajgiri (D)-501301  
Telangana State

  
PRINCIPAL  
Vignans Institute of Management & Technology For Women  
Kondapur (V), Ghatkesar (M), Medchal-Malkajgiri (D)-501301  
Telangana State



# VIGNAN'S INSTITUTE OF MANAGEMENT AND TECHNOLOGY FOR WOMEN

(Sponsored by Lavu Educational Society)

Approved by AICTE, New Delhi & Affiliated to JNTUH, Hyderabad.

Kondapur (V), Ghatkesar (M), Medchal - Malkajgiri (D) - 501 301

Accredited By



## Certificate of Participation

This is to certify that Mr./Ms./Mrs. Ch. Mounika

of CSE, Vignans Institute of management & Technology for women,  
has participated in a Seminar on "Quality Research Publications" held on 28-07-2020, Organized  
by IQAC, Vignans Institute of Management and Technology for Women.

*CP*

Co-ordinator

Quality Assurance Cell

Vignans Institute of Management & Technology for Women  
Kondapur (V), Ghatkesar (M), Medchal-Malkajgiri (D)-501301  
Telangana State



*ASH*

PRINCIPAL

Vignans Institute of Management & Technology for Women  
Kondapur (V), Ghatkesar (M), Medchal-Malkajgiri (D)-501301  
Telangana State

*ASH*

PRINCIPAL

Vignans Institute of Management & Technology for Women  
Kondapur (V), Ghatkesar (M), Medchal-Malkajgiri (D)-501301  
Telangana State



# VIGNAN'S INSTITUTE OF MANAGEMENT AND TECHNOLOGY FOR WOMEN

(Sponsored by Lavu Educational Society)  
Approved by AICTE, New Delhi & Affiliated to JNTUH, Hyderabad.

Kondapur (V), Ghatkesar (M), Medchal - Malkajgiri (D) - 501 301



## Certificate of Participation

This is to certify that Mr./Ms./Mrs. Dr. A. Premalatha  
of BSK, Vignan's Institute of management & Technology for women  
has participated in a Seminar on "Quality Research Publications" held on 28-07-2020, Organized  
by IQAC, Vignan's Institute of Management and Technology for Women.



  
Co-ordinator  
Quality Assurance Cell  
Vignan's Institute of Management & Technology For Women  
Kondapur (V), Ghatkesar (M), Medchal-Malkajgiri (D)-501301  
Telangana State

  
Principal

Vignan's Institute of Management & Technology For Women  
Kondapur (V), Ghatkesar (M), Medchal-Malkajgiri (D)-501301  
Telangana State



PRINCIPAL  
Vignan's Institute of Management & Technology For Women  
Kondapur (V), Ghatkesar (M), Medchal-Malkajgiri (D)-501301  
Telangana State



# VIGNAN'S INSTITUTE OF MANAGEMENT AND TECHNOLOGY FOR WOMEN

(Sponsored by Lawu Educational Society)

Approved by AICTE, New Delhi & Affiliated to JNTUH, Hyderabad.

Kondapur (V), Ghatkesar (M), Medchal - Malkajgiri (D) - 501 301

Accredited By



## Certificate of Participation

This is to certify that Mr./Ms./Mrs. Srinivasulu Thonukunuri  
of BSH, Vignans Institute of management & Technology for Women  
has participated in a Seminar on "Quality Research Publications" held on 28-07-2020, Organized  
by IQAC, Vignans Institute of Management and Technology for Women.

*VP*

Co-ordinator  
Quality Assurance Cell  
Co-ordinator of Management & Technology for Women  
Vignans Institute of Management & Technology for Women  
Kondapur (V), Ghatkesar (M), Medchal-Malkajgiri (D)-501301  
Telangana State



*VP*

PRINCIPAL  
Vignans Institute of Management & Technology For Women  
Kondapur (V), Ghatkesar (M), Medchal-Malkajgiri (D) - 501301  
Telangana State

*VP*

PRINCIPAL  
Vignans Institute of Management & Technology For Women  
Kondapur (V), Ghatkesar (M), Medchal-Malkajgiri (D) - 501301  
Telangana State



# VIGNAN'S INSTITUTE OF MANAGEMENT AND TECHNOLOGY FOR WOMEN

(Sponsored by Lavu Educational Society)

Approved by AICTE, New Delhi & Affiliated to JNTUH, Hyderabad.

Kondapur (V), Ghatkesar (M), Medchal - Malkajgiri (D) - 501 301

Accredited By



## Certificate of Participation

This is to certify that Mr./Ms./Mrs. Y. Sathish

of BSH, Vignans Institute of Management & Technology for Women  
has participated in a Seminar on "Quality Research Publications" held on 28-07-2020, Organized  
by IQAC, Vignans Institute of Management and Technology for Women.



Co-ordinator

Quality Assurance Cell  
Vignans Institute of Management & Technology For Women

Kondapur (V), Ghatkesar (M), Medchal-Malkajgiri (D)-501301  
Telangana State





PRINCIPAL

Vignans Institute of Management & Technology For Women  
Kondapur (V), Ghatkesar (M), Medchal-Malkajgiri (D) District  
Telangana State



PRINCIPAL

Vignans Institute of Management & Technology For Women  
Kondapur (V), Ghatkesar (M), Medchal-Malkajgiri (D)-501301  
Telangana State





# VIGNAN'S INSTITUTE OF MANAGEMENT AND TECHNOLOGY FOR WOMEN

(Sponsored by Lavu Educational Society)  
Approved by AICTE, New Delhi & Affiliated to JNTUH, Hyderabad.  
Kondapur (M), Ghatkesar (M), Medchal - Malkajgiri (D) - 501 301



## Certificate of Participation

This is to certify that Mr./Ms./Mrs. Dileep Thotakuri  
of BSH, Vignans Institute of management & Technology for women  
has participated in a Seminar on "Quality Research Publications" held on 28-07-2020, Organized  
by IQAC, Vignans Institute of Management and Technology for Women.



  
Co-ordinator  
Quality Assurance Cell  
Vignans Institute of Management & Technology For Women  
Kondapur (M), Ghatkesar (M), Medchal-Malkajgiri (D)-501301  
Telangana State

  
PRINCIPAL  
Vignans Institute of Management & Technology For Women  
Kondapur (M), Ghatkesar (M), Medchal-Malkajgiri (D) - 501301  
Telangana State

  
PRINCIPAL  
Vignans Institute of Management & Technology For Women  
Kondapur (M), Ghatkesar (M), Medchal-Malkajgiri (D)-501301  
Telangana State



# VIGNAN'S INSTITUTE OF MANAGEMENT AND TECHNOLOGY FOR WOMEN

(Sponsored by Lavu Educational Society)

Approved by AICTE, New Delhi & Affiliated to JNTUH, Hyderabad.

Kondapur (V), Ghatkesar (M), Medchal - Malkajgiri (D) - 501 301

Accredited By



## Certificate of Participation

This is to certify that Mr./Ms./Mrs. Kavitha Denti

of BSH, Vignans Institute of management & Technology for women  
has participated in a Seminar on "Quality Research Publications" held on 28-07-2020, Organized  
by IQAC, Vignans Institute of Management and Technology for Women.



Co-ordinator  
Quality Assurance Cell  
Vignans Institute of Management & Technology For Women  
Kondapur (V), Ghatkesar (M), Medchal-Malkajgiri (D)-501301  
Telangana State



  
Principal  
Vignans Institute of Management & Technology For Women  
Kondapur (V), Ghatkesar (M), Medchal-Malkajgiri (D)-501301  
Telangana State

  
PRINCIPAL  
Vignans Institute of Management & Technology For Women  
Kondapur (V), Ghatkesar (M), Medchal-Malkajgiri (D)-501301  
Telangana State



# VIGNAN'S INSTITUTE OF MANAGEMENT AND TECHNOLOGY FOR WOMEN

(Sponsored by Lavu Educational Society)

Approved by AICTE, New Delhi & Affiliated to JNTUH, Hyderabad.

Kondapur (M), Ghatkesar (M), Medchal - Malkajgiri (D) - 501 301

Accredited By



NATIONAL BOARD  
of ACCREDITATION

CSE & EC

## Certificate of Participation

This is to certify that Mr./Ms./Mrs. Santhosh Kumar Kodam  
of BSK, Vignana's Institute of management & Technology for women  
has participated in a Seminar on "Quality Research Publications" held on 28-07-2020, Organized  
by IQAC, Vignana's Institute of Management and Technology for Women.

Co-ordinator  
Quality Assurance Cell  
Vignana's Institute of Management & Technology For Women  
Kondapur (M), Ghatkesar (M), Medchal-Malkajgiri (D)-501301  
Telangana State



PRINCIPAL

Vignana's Institute of Management & Technology For Women  
Kondapur (M), Ghatkesar (M), Medchal-Malkajgiri (D)-501301  
Telangana State

PRINCIPAL

Vignana's Institute of Management & Technology For Women  
Kondapur (M), Ghatkesar (M), Medchal-Malkajgiri (D)-501301  
Telangana State



# VIGNAN'S INSTITUTE OF MANAGEMENT AND TECHNOLOGY FOR WOMEN

(Sponsored by Lavu Educational Society)

Approved by AICTE, New Delhi & Affiliated to JNTUH, Hyderabad.

Kondapur (V), Ghatkesar (M), Medchal - Malkajgiri (D) - 501 301



## Certificate of Participation

This is to certify that Mr./Ms./Mrs. Komarelli Bal Reddy  
of BSH, Vignans Institute of management & Technology for Women  
has participated in a Seminar on "Quality Research Publications" held on 28-07-2020, Organized  
by IQAC, Vignans Institute of Management and Technology for Women.

*Handwritten signature*  
PRINCIPAL  
Vignans Institute of Management & Technology For Women  
Kondapur (V), Ghatkesar (M), Medchal-Malkajgiri (D), 501301  
Telangana State



*Handwritten signature*  
Co-ordinator  
Quality Assurance Cell  
Co-ordinator of IQAC & Technology For Women  
Vignans Institute of Management & Technology For Women  
Kondapur (V), Ghatkesar (M), Medchal-Malkajgiri (D)-501301  
Telangana State

*Handwritten signature*  
PRINCIPAL  
Vignans Institute of Management & Technology For Women  
Kondapur (V), Ghatkesar (M), Medchal-Malkajgiri (D)-501301  
Telangana State



# VIGNAN'S INSTITUTE OF MANAGEMENT AND TECHNOLOGY FOR WOMEN

(Sponsored by Lavu Educational Society)

Approved by AICTE, New Delhi & Affiliated to JNTUH, Hyderabad.

Kondapur (M), Ghatkesar (M), Medchal - Malkajgiri (D) - 501 301

Accredited By



## Certificate of Participation

This is to certify that Mr./Ms./Mrs. Maddi Swamy

of BSH, Vignans Institute of management & Technology, for women  
has participated in a Seminar on "Quality Research Publications" held on 28-07-2020, Organized  
by IQAC, Vignans Institute of Management and Technology for Women.

Co-ordinator

Quality Assurance Cell

Vignans Institute of Management & Technology For Women  
Kondapur (M), Ghatkesar (M), Medchal-Malkajgiri (D)-501301

Telangana State



PRINCIPAL

Vignans Institute of Management & Technology For Women  
Kondapur (M), Ghatkesar (M), Medchal-Malkajgiri (D)-501301

Telangana State

PRINCIPAL

Vignans Institute of Management & Technology For Women  
Kondapur (M), Ghatkesar (M), Medchal-Malkajgiri (D)-501301

Telangana State



# VIGNAN'S INSTITUTE OF MANAGEMENT AND TECHNOLOGY FOR WOMEN

(Sponsored by Lavu Educational Society)  
Approved by AICTE, New Delhi & Affiliated to JNTUH, Hyderabad.

Kondapur (M), Ghatkesar (M), Medchal - Malkajgiri (D) - 501 301



## Certificate of Participation

This is to certify that Mr./Mrs. A. Mallikarjuna

of BSH, Vignans Institute of management & Technology for women  
has participated in a Seminar on "Quality Research Publications" held on 28-07-2020, Organized  
by IQAC, Vignans Institute of Management and Technology for Women.

  
Co-ordinator  
Quality Assurance Cell  
Vignans Institute of Management & Technology For Women  
Kondapur (M), Ghatkesar (M), Medchal-Malkajgiri (D)-501301  
Telangana State



  
PRINCIPAL

Vignans Institute of Management & Technology For Women  
Kondapur (M), Ghatkesar (M), Medchal-Malkajgiri (D)-501301  
Telangana State



PRINCIPAL

Vignans Institute of Management & Technology For Women  
Kondapur (M), Ghatkesar (M), Medchal-Malkajgiri (D)-501301  
Telangana State



# VIGNAN'S INSTITUTE OF MANAGEMENT AND TECHNOLOGY FOR WOMEN

Accredited By  
**NBA**  
NATIONAL BOARD OF ACCREDITATION  
**CSE & EC**

(Sponsored by Laxmi Educational Society)  
Approved by AICTE, New Delhi & Affiliated to JNTUH, Hyderabad.  
Kondapur (M), Ghatkesar (M), Medchal - Malkajgiri (D) - 501 301

## Certificate of Participation

This is to certify that Mr./Ms./Mrs. Suzanshalini Vurum  
of BSH, Vignana's Institute of management & Technology for women  
has participated in a Seminar on "Quality Research Publications" held on 28-07-2020, Organized  
by IQAC, Vignana's Institute of Management and Technology for Women.



  
Co-ordinator  
Quality Assurance Cell  
Vignana's Institute of Management & Technology For Women  
Kondapur (M), Ghatkesar (M), Medchal-Malkajgiri (D)-501301  
Telangana State

  
PRINCIPAL  
Vignana's Institute of Management & Technology For Women  
Kondapur (M), Ghatkesar (M), Medchal-Malkajgiri (D)-501301  
Telangana State

  
PRINCIPAL  
Vignana's Institute of Management & Technology For Women  
Kondapur (M), Ghatkesar (M), Medchal-Malkajgiri (D)-501301  
Telangana State



# VIGNAN'S INSTITUTE OF MANAGEMENT AND TECHNOLOGY FOR WOMEN

(Sponsored by Lavu Educational Society)

Approved by AICTE, New Delhi & Affiliated to JNTUH, Hyderabad.

Kondapur (V), Ghatkesar (M), Medchal - Malkajgiri (D) - 501 301

Accredited By



## Certificate of Participation

This is to certify that Mr./Ms./Mrs. Venkatesham Borra

of BSH, Vignans Institute of management & technology for women  
has participated in a Seminar on "Quality Research Publications" held on 28-07-2020, Organized  
by IQAC, Vignans Institute of Management and Technology for Women.

Co-ordinator  
Quality Assurance Cell  
Vignans Institute of Management & Technology For Women  
Kondapur (V), Ghatkesar (M), Medchal-Malkajgiri (D)-501301  
Telangana State



PRINCIPAL

Vignans Institute of Management & Technology For Women  
Kondapur (V), Ghatkesar (M), Medchal-Malkajgiri (D)-501301  
Telangana State

PRINCIPAL

Vignans Institute of Management & Technology For Women  
Kondapur (V), Ghatkesar (M), Medchal-Malkajgiri (D)-501301  
Telangana State





# VIGNAN'S INSTITUTE OF MANAGEMENT AND TECHNOLOGY FOR WOMEN

(Sponsored by Lavu Educational Society)  
Approved by AICTE, New Delhi & Affiliated to JNTUH, Hyderabad.

Kondapur (V), Ghatkesar (M), Medchal - Malkajgiri (D) - 501 301



## Certificate of Participation

This is to certify that Mr./Ms./Mrs. Prasad Grattu  
of BSH, Vignana's Institute of management & Technology for women  
has participated in a Seminar on "Quality Research Publications" held on 28-07-2020, Organized  
by IQAC, Vignana's Institute of Management and Technology for Women.

*VP*

Co-ordinator  
Quality Assurance Cell  
Vignana's Institute of Management & Technology For Women  
Kondapur (V), Ghatkesar (M), Medchal-Malkajgiri (D)-501301  
Telangana State



*raah*

PRINCIPAL  
Vignana's Institute of Management & Technology For Women  
Kondapur (V), Ghatkesar (M), Medchal-Malkajgiri (D)-501301  
Telangana State

*raah*

PRINCIPAL  
Vignana's Institute of Management & Technology For Women  
Kondapur(V), Ghatkesar(M), Medchal-Malkajgiri(D)-501301  
Telangana State



# VIGNAN'S INSTITUTE OF MANAGEMENT AND TECHNOLOGY FOR WOMEN

(Sponsored by Lavu Educational Society)

Approved by AICTE, New Delhi & Affiliated to JNTUH, Hyderabad.

Kondapur (V), Ghatkesar (M), Medchal - Malkajgiri (D) - 501 301

Accredited By



## Certificate of Participation

This is to certify that Mr./Ms./Mrs. Raja Baby Kammoluri  
of BSH, Vignan's Institute of management & Technology for women  
has participated in a Seminar on "Quality Research Publications" held on 28-07-2020, Organized  
by IQAC, Vignan's Institute of Management and Technology for Women.

Co-ordinator

Co-ordinator  
Quality Assurance Cell

Vignan's Institute of Management & Technology For Women  
Kondapur (V), Ghatkesar (M), Medchal-Malkajgiri (D)-501301  
Telangana State



PRINCIPAL

Vignan's Institute of Management & Technology For Women  
Kondapur (V), Ghatkesar (M), Medchal-Malkajgiri (D)-501301  
Telangana State

PRINCIPAL

Vignan's Institute of Management & Technology For Women  
Kondapur (V), Ghatkesar (M), Medchal-Malkajgiri (D)-501301  
Telangana State



# VIGNAN'S INSTITUTE OF MANAGEMENT AND TECHNOLOGY FOR WOMEN

(Sponsored by Lavu Educational Society)

Approved by AICTE, New Delhi & Affiliated to JNTUH, Hyderabad.

Kondapur (M), Ghatkesar (M), Medchal - Malkajgiri (D) - 501 301

Accredited By



## Certificate of Participation

This is to certify that Mr./Ms./Mrs. Vinutha Kandakuri

of BSH, Vignans Institute of management & Technology for women  
has participated in a Seminar on "Quality Research Publications" held on 28-07-2020, Organized  
by IQAC, Vignans Institute of Management and Technology for Women.



Co-ordinator

Quality Assurance Cell

Vignans Institute of Management & Technology For Women  
Kondapur (M), Ghatkesar (M), Medchal-Malkajgiri (D)-501301  
Telangana State





PRINCIPAL

Vignans Institute of Management & Technology For Women  
Kondapur (M), Ghatkesar (M), Medchal-Malkajgiri (D)-501301  
Telangana State



PRINCIPAL

Vignans Institute of Management & Technology For Women  
Kondapur (M), Ghatkesar (M), Medchal-Malkajgiri (D)-501301  
Telangana State



# VIGNAN'S INSTITUTE OF MANAGEMENT AND TECHNOLOGY FOR WOMEN

(Sponsored by Lavu Educational Society)

Approved by AICTE, New Delhi & Affiliated to JNTUH, Hyderabad.

Kondapur (V), Ghatkesar (M), Medchal - Malkajgiri (D) - 501 301

Accredited By



## A SEMINAR ON **RESEARCH & INNOVATION**

**31<sup>ST</sup> AUGUST, 2021 @ 10:30 AM**

**Venue: SEMINAR HALL**



Resource Person:  
**Dr. Udaya Kiran,**  
Principal,  
Bhaskar Engineering College,  
Hyderabad.

Chief Patron:  
**Dr. Lavu Rathalish,**  
Chairman, Vignan Group.

Patron:  
**Mr. B. Shrovan,**  
CEO, Vignan Group.

Co-Patron:  
**Dr. G. Apparao Naidu,**  
Principal, VMTW.

Advisor:  
**Mr. G. Rajesh,**  
Co-Ordinator, IQAC.

Program Co-Ordinator:  
**Mrs. K. Helini,**  
Assistant Professor, IT.  
Call: +91 96529 10002



**INTERNAL QUALITY ASSURANCE CELL (IQAC)**



*Handwritten signature*  
**PRINCIPAL**  
Vignan's Institute of Management & Technology for Women  
Kondapur(V), Ghatkesar(M), Medchal-Malkajgiri (D) - 501301  
Telangana State

Date: 28/08/2021

To  
The Principal,  
VMTW,  
Kondapur, Ghatkesar.

Subject: Approval to conduct a Seminar on "Research and Innovation" Req-Reg:-

Respected sir,

IQAC is planning to organize a one day Seminar on "Research and Innovations" on 31/08/2021. I am writing to request your kind support and permission in organizing a seminar on research and innovation. The main objective of this seminar is to provide a platform for researchers, academicians to exchange ideas, share insights, and discuss the latest advancements in various fields of research and innovation.

So I request you to give permission for conducting this Seminar.

Thank you sir.

Yours Faithfully

  
Rajesh G

Co-ordinator, IQAC



  
PRINCIPAL  
Vignona's Institute of Management & Technology For Women  
Kondapur (V), Ghatkesar (M), Medchal-Malkajgiri (Dt)-501301  
Telangana State

<p><b>Name</b> Dr. C. Udaya Kiran, Principal, BHASKAR ENGINEERING COLLEGE, YENKAPALLY, MOINABAD MANDAL, RANGA REDDY DISTRICT, HYDERABAD</p> <p><b>Telephone</b> 08413-235046/ 235684/ 85</p> <p><b>E-Mail</b> principal@bec.edu.in</p>	
--	--

Dr. C. Udaya Kiran, with the College leadership team, promotes standards of Teaching, Research and quality of the Institution. He, with his 19 years of Teaching and administrative experience, manages, monitors and controls to improve the quality of various educational activities of the Institution. He is also a Professor of Mechanical Engineering.

He obtained his B.Tech Degree (1992) in Mechanical Engineering from GPREC, SK University. He is a second rank holder in M.Tech in Production Engineering (2000) from VT University. He is awarded with Ph.D degree (Mechanical) in composite materials from SRTM University, in the year 2008. He is guiding a group of research scholars who are carrying out research in the area of Polymer composites, Bio composites and Nanocomposites.

He is a recognized research supervisor from JNTUH, JNTUA and KLU. One of his students submitted her Ph.D thesis to JNTUH for her Ph.D. He has published more than 55 papers in peer reviewed International journals. He has been acting as a Reviewer for various journals like Journal of Reinforced Plastics and Composites, Journal of Thermal Engineering, Journal of Chemical Engineering and Materials Science.

He is appointed as an Editorial Board Member of Journal of Materials Sciences and Applications, American Journal of Materials Research, AASCIT Materials, Editor for International Journal of Computer Science Information and Engineering Technologies. He is a life member of ISTE. He got best Paper Award with Cash Prize in an International Conference (2005) held by Shinshu University, Japan.



  
 PRINCIPAL  
 Vignna's Institute of Management & Technology For Women  
 Kondapur(V), Ghatkesar(M), Medchal-Malkajgiri(Dr)-501301  
 Telangana State



Date:31/08/21

## Seminar on "Research and Innovation"

The seminar aimed to create an environment that promotes research excellence and encourages innovation among faculty members. The sessions conducted covered a wide range of topics related to research methodologies, emerging trends, ethical considerations, and the dissemination of research findings. The seminar attracted a diverse audience, including faculty members from various disciplines.

### The key highlights of the seminar include:

**Inaugural Session:** The seminar began with an inaugural session where Dr.G.Apparao Naidu,Principal sir,VMTW delivered a keynote address emphasizing the importance of research and innovation in academic growth and societal development. The session further handed over to the guest Dr. C. Udaya Kiran ,Principal,Bhaskar Engineering college. The session provided an overview of the seminar's objectives and set the tone for the subsequent sessions.



*ASH*  
PRINCIPAL

Vignans Institute of Management & Technology for Women  
Kondapur(V), Ghatkesar(M), Medchal-Malkajgiri(D)-501301  
Telangana State



**Research Methodologies and Tools:** The participants learned about quantitative and qualitative research methods, data analysis techniques, and the use of software/tools for research. The sessions were highly engaging, allowing participants to clarify doubts and gain practical insights into conducting high-quality research.

**Emerging Trends in Research:** This seminar provided a platform to discuss emerging trends in different fields of research. Speaker presented case studies and shared insights into the latest advancements in areas such as artificial intelligence, big data analytics, biotechnology, sustainability, and digital technologies. The participants were inspired to explore these emerging areas and consider their potential for innovative research.



*ASH*  
PRINCIPAL

Vignan's Institute of Management & Technology For Women  
Kondapur(V),Ghatkesar(M),Medchal-Malkajgiri(D)-501301  
Telangana State





**Ethical Considerations in Research:** A session dedicated to research ethics and responsible conduct of research was conducted. The session highlighted the importance of ethical considerations, proper citation practices, intellectual property rights, and avoiding plagiarism in research work. The participants gained a deeper understanding of ethical principles and their application in research.

**Learning Outcomes:**

The seminar facilitated the exchange of ideas, best practices, and emerging trends in various fields of research. It emphasized the importance of ethical considerations, research methodologies, and the dissemination of research findings.

This seminar ended with a formal vote of thanks by IQAC Co-Ordinator. He expressed his sincere appreciation to our esteemed speaker who generously shared his expertise and experiences.



*[Handwritten Signature]*  
PRINCIPAL  
Vignan's Institute of Management & Technology For Women  
Kondapur(V), Ghatkesar(M), Medchal-Malkajgiri(D)-501301  
Telangana State

*[Handwritten Signature]*  
Program Co-ordinator



# VIGNAN'S INSTITUTE OF MANAGEMENT AND TECHNOLOGY FOR WOMEN

Accredited By



(Sponsored by Lavu Educational Society)

Approved by AICTE, New Delhi & Affiliated to JNTUH, Hyderabad.

Kondapur (V), Ghatkesar (M), Medchal - Malkajgiri (D) - 501 301

## CERTIFICATE OF PARTICIPATION

This is to certify that Mr./Ms./Mrs. K. Chandana

of B.S.H. Vignans's Institute of Management and Technology for Women

has participated in a Seminar on "Research and Innovation" held on 31-08-2021, Organized by IQAC, Vignans's Institute of Management and Technology for Women.



 Co-ordinator  
**Co-ordinator IQAC**  
Vignans's Institute of Management and Technology for Women  
Kondapur (V), Ghatkesar (M), Medchal-Malkajgiri (D) - 501301

 PRINCIPAL  
Vignans's Institute of Management & Technology for Women  
Kondapur(V), Ghatkesar(M), Medchal-Malkajgiri(D)-501301  
Telangana State

 PRINCIPAL  
**Principal**  
Vignans's Institute of Management & Technology for Women  
Kondapur(V), Ghatkesar(M), Medchal-Malkajgiri(D)-501301  
Telangana State



# VIGNAN'S INSTITUTE OF MANAGEMENT AND TECHNOLOGY FOR WOMEN

(Sponsored by Lavu Educational Society)

Approved by AICTE, New Delhi & Affiliated to JNTUH, Hyderabad.

Kondapur (V), Ghatkesar (M), Medchal - Malkajgiri (D) - 501 301

Accredited By



CSE & ECE

## CERTIFICATE OF PARTICIPATION

This is to certify that Mr./Ms./Mrs. B. Phijik

of IT, Vignans Institute of Management and Technology for Women

has participated in a Seminar on "Research and Innovation" held on 31-08-2021,  
Organized by IQAC, Vignans Institute of Management and Technology for Women.

  
Co-ordinator IQAC  
Vignans Institute of Management and Technology for Women  
Kondapur (V), Ghatkesar (M), Medchal - Malkajgiri (D) - 501 301  
Telangana State

  
Principal  
Vignans Institute of Management and Technology for Women  
Kondapur (V), Ghatkesar (M), Medchal - Malkajgiri (D) - 501 301  
Telangana State

Principal  
Vignans Institute of Management and Technology for Women  
Kondapur (V), Ghatkesar (M), Medchal - Malkajgiri (D) - 501 301  
Telangana State



# VIGNAN'S INSTITUTE OF MANAGEMENT AND TECHNOLOGY FOR WOMEN

(Sponsored by Lavu Educational Society)  
Approved by AICTE, New Delhi & Affiliated to JNTUH, Hyderabad.

Kondapur (V), Ghatkesar (M), Medchal - Malkajgiri (D) - 501 301

Accredited By



CSE & ECE

## CERTIFICATE OF PARTICIPATION

This is to certify that Mr./Ms./Mrs. K. Bharath Reddy  
of IT, Vignans Institute of Management and Technology for Women  
has participated in a Seminar on "Research and Innovation" held on 31-08-2021,  
Organized by IQAC, Vignans Institute of Management and Technology for Women.



  
Co-ordinator,  
IQAC For Women  
Women's Institute of Management & Technology for Women  
Kondapur (V), Ghatkesar (M), Medchal-Malkajgiri (D)-501301

  
PRINCIPAL  
Vignans Institute of Management & Technology for Women  
Kondapur(V), Ghatkesar(M), Medchal-Malkajgiri(D)-501301  
Telangana State

  
PRINCIPAL  
Vignans Institute of Management & Technology for Women  
Kondapur(V), Ghatkesar(M), Medchal-Malkajgiri(D)-501301  
Telangana State



# VIGNAN'S INSTITUTE OF MANAGEMENT AND TECHNOLOGY FOR WOMEN

(Sponsored by Lavu Educational Society)

Approved by AICTE, New Delhi & Affiliated to JNTUH, Hyderabad.

Kondapur (V), Ghatkesar (M), Medchal - Malkajgiri (D) - 501 301

Accredited By



NATIONAL BOARD OF ACCREDITATION

CSE & ECE

## CERTIFICATE OF PARTICIPATION

This is to certify that Mr./Ms./Mrs. K. Helini

of IT, Vignans Institute of Management and Technology for Women

has participated in a Seminar on "Research and Innovation" held on 31-08-2021.

Organized by IQAC, Vignans Institute of Management and Technology for Women.



*[Handwritten Signature]*

PRINCIPAL

Vignans Institute of Management & Technology for Women  
Kondapur(V), Ghatkesar(M), Medchal-Malkajgiri(D)-501301  
Telangana State

*[Handwritten Signature]*

Co-ordinator

Quality Assurance Cell

Vignans Institute of Management and Technology for Women  
Kondapur (V), Ghatkesar (M), Medchal-Malkajgiri (D)-501301  
Telangana State

*[Handwritten Signature]*

PRINCIPAL

Vignans Institute of Management & Technology for Women  
Kondapur(V), Ghatkesar(M), Medchal-Malkajgiri(D)-501301  
Telangana State



# VIGNAN'S INSTITUTE OF MANAGEMENT AND TECHNOLOGY FOR WOMEN

(Sponsored by Lavu Educational Society)

Approved by AICTE, New Delhi & Affiliated to JNTUH, Hyderabad.

Kondapur (V), Ghatkesar (M), Medchal - Malkajgiri (D) - 501 301

Accredited By



CSE & ECE

## CERTIFICATE OF PARTICIPATION

This is to certify that Mr./Mrs./Dr. S. Gayaz  
of ECE, Vignans Institute of Management and Technology for Women

has participated in a Seminar on "Research and Innovation" held on 31-08-2021,  
Organized by IQAC, Vignans Institute of Management and Technology for Women.



*[Signature]* Co-ordinator  
**Co-ordinator, IQAC**  
Vignans Institute of Management and Technology for Women  
Kondapur (V), Ghatkesar (M), Medchal-Malkajgiri (D) - 501301  
Telangana State

*[Signature]*

PRINCIPAL

Vignans Institute of Management & Technology For Women  
Kondapur(V), Ghatkesar(M), Medchal-Malkajgiri(D)-501301  
Telangana State

*[Signature]*  
PRINCIPAL  
Vignans Institute of Management & Technology For Women  
Kondapur(V), Ghatkesar(M), Medchal-Malkajgiri(D)-501301  
Telangana State



# VIGNAN'S INSTITUTE OF MANAGEMENT AND TECHNOLOGY FOR WOMEN

(Sponsored by Lavu Educational Society)

Approved by AICTE, New Delhi & Affiliated to JNTUH, Hyderabad.

Kondapur (V), Ghatkesar (M), Medchal - Malkajgiri (D) - 501 301

Accredited By



NATIONAL BOARD OF ACCREDITATION

CSE & ECE

## CERTIFICATE OF PARTICIPATION

This is to certify that Mr./Ms./Mrs./Dr. Sarinava Chatterjee  
of ECE, Vignans Institute of Management and Technology for Women

has participated in a Seminar on "Research and Innovation" held on 31-08-2021,

Organized by IQAC, Vignans Institute of Management and Technology for Women.



 Co-ordinator

**Co-ordinator IQAC**  
Vignans Institute of Management and Technology for Women  
Kondapur (V), Ghatkesar (M), Medchal-Malkajgiri (D)-501301

 PRINCIPAL

Vignans Institute of Management & Technology for Women  
Kondapur(V), Ghatkesar(M), Medchal-Malkajgiri(D)-501301  
Telangana State

 PRINCIPAL  
Vignans Institute of Management & Technology for Women  
Kondapur(V), Ghatkesar(M), Medchal-Malkajgiri(D)-501301  
Telangana State



# VIGNAN'S INSTITUTE OF MANAGEMENT AND TECHNOLOGY FOR WOMEN

(Sponsored by Lavu Educational Society)

Approved by AICTE, New Delhi & Affiliated to JNTUH, Hyderabad.

Kondapur (V), Ghatkesar (M), Medchal - Malkajgiri (D) - 501 301

Accredited By



CSE & ECE

## CERTIFICATE OF PARTICIPATION

This is to certify that Mr./Ms./Mrs: Sivilkumar Tangili  
of ECE, Vignans Institute of Management and Technology for Women

has participated in a Seminar on "Research and Innovation" held on 31-08-2021,  
Organized by IQAC, Vignans Institute of Management and Technology for Women.



  
Co-ordinator  
Quality Assurance Cell  
Co-ordinator, IQAC  
Vignans Institute of Management and Technology for Women  
Kondapur (V), Ghatkesar (M), Medchal-Malkajgiri (D)-501301

  
PRINCIPAL  
Vignans Institute of Management & Technology for Women  
Kondapur (V), Ghatkesar (M), Medchal-Malkajgiri (D)-501301  
Telangana State

  
PRINCIPAL  
Vignans Institute of Management & Technology for Women  
Kondapur (V), Ghatkesar (M), Medchal-Malkajgiri (D)-501301  
Telangana State





# VIGNAN'S INSTITUTE OF MANAGEMENT AND TECHNOLOGY FOR WOMEN

(Sponsored by Lavu Educational Society)

Approved by AICTE, New Delhi & Affiliated to JNTUH, Hyderabad.

Kondapur (V), Ghatkesar (M), Medchal - Malkajgiri (D) - 501 301

Accredited By



NATIONAL BOARD OF ACCREDITATION

CSE & ECE

## CERTIFICATE OF PARTICIPATION

This is to certify that Mr./Ms./Mrs. S. Pullaiah  
of ECE, Vignans Institute of Management and Technology for Women  
has participated in a Seminar on "Research and Innovation" held on 31-08-2021,  
Organized by IQAC, Vignans Institute of Management and Technology for Women.



  
Co-ordinator  
Quality Assurance Cell  
**Co-ordinator IQAC**  
Vignans Institute of Management and Technology for Women  
Kondapur (V), Ghatkesar (M), Medchal-Malkajgiri (D)-501301  
Telangana State

  
PRINCIPAL

Vignans Institute of Management & Technology For Women  
Kondapur(V),Ghatkesar(M),Medchal-Malkajgiri(D)-501301  
Telangana State

  
PRINCIPAL  
Vignans Institute of Management & Technology For Women  
Kondapur(V),Ghatkesar(M),Medchal-Malkajgiri(D)-501301  
Telangana State



# VIGNAN'S INSTITUTE OF MANAGEMENT AND TECHNOLOGY FOR WOMEN

(Sponsored by Lavu Educational Society)

Approved by AICTE, New Delhi & Affiliated to JNTUH, Hyderabad.

Kondapur (V), Ghatkesar (M), Medchal - Malkajgiri (D) - 501 301

Accredited By



CSE & ECE

## CERTIFICATE OF PARTICIPATION

This is to certify that Mr./Ms./Mrs. Vijay Kumar R. Urkude  
of ECE, Vignans Institute of Management and Technology for Women  
has participated in a Seminar on "Research and Innovation" held on 31-08-2021,  
Organized by IQAC, Vignans Institute of Management and Technology for Women.



 Co-ordinator  
**Co-ordinator IQAC**  
Vignans Institute of Management and Technology for Women  
Kondapur (V), Ghatkesar (M), Medchal-Malkajgiri (D) - 501301



PRINCIPAL

Vignans Institute of Management & Technology for Women  
Kondapur (V), Ghatkesar (M), Medchal-Malkajgiri (D) - 501301  
Telangana State

  
PRINCIPAL  
Vignans Institute of Management & Technology for Women  
Kondapur (V), Ghatkesar (M), Medchal-Malkajgiri (D) - 501301  
Telangana State



# VIGNAN'S INSTITUTE OF MANAGEMENT AND TECHNOLOGY FOR WOMEN

(Sponsored by Lavu Educational Society)

Approved by AICTE, New Delhi & Affiliated to JNTUH, Hyderabad.

Kondapur (M), Ghatkesar (M), Medchal - Malkajgiri (D) - 501 301

Accredited By



CSE & ECE

## CERTIFICATE OF PARTICIPATION

This is to certify that Mr./Ms./Mrs. Ashok Reddy Katta  
of ECE, Vignans Institute of Management and Technology for Women  
has participated in a Seminar on "Research and Innovation" held on 31-08-2021,  
Organized by IQAC, Vignans Institute of Management and Technology for Women.



 Co-ordinator  
**Co-ordinator IQAC**  
Vignans Institute of Management & Technology For Women  
Kondapur (M), Ghatkesar (M), Medchal-Malkajgiri (D)-501301

 PRINCIPAL

Vignans Institute of Management & Technology For Women  
Kondapur (M), Ghatkesar (M), Medchal-Malkajgiri (D)-501301  
Telangana State

 PRINCIPAL  
**Principal**  
Vignans Institute of Management & Technology For Women  
Kondapur (M), Ghatkesar (M), Medchal-Malkajgiri (D)-501301  
Telangana State



# VIGNAN'S INSTITUTE OF MANAGEMENT AND TECHNOLOGY FOR WOMEN

(Sponsored by Lavu Educational Society)

Approved by AICTE, New Delhi & Affiliated to JNTUH, Hyderabad.

Kondapur (V), Ghatkesar (M), Medchal - Malkajgiri (D) - 501 301

Accredited By



CSE & ECE

## CERTIFICATE OF PARTICIPATION

This is to certify that Mr./Ms./Mrs. Bhuvan Mahesh  
of ECE, Vignan's Institute of Management and Technology for Women  
has participated in a Seminar on "Research and Innovation" held on 31-08-2021,  
Organized by IQAC, Vignan's Institute of Management and Technology for Women.



A. J. S. Co-ordinator  
**Co-ordinator IQAC**  
Vignan's Institute of Management and Technology for Women  
Kondapur (V), Ghatkesar (M), Medchal-Malkajgiri (D)-501301

R. Ach.  
**PRINCIPAL**

Vignan's Institute of Management & Technology For Women  
Kondapur(V), Ghatkesar(M), Medchal-Malkajgiri(D)-501301  
Telangana State

R. Ach.  
**PRINCIPAL**  
Vignan's Institute of Management & Technology For Women  
Kondapur(V), Ghatkesar(M), Medchal-Malkajgiri(D)-501301  
Telangana State



# VIGNAN'S INSTITUTE OF MANAGEMENT AND TECHNOLOGY FOR WOMEN

(Sponsored by Lavu Educational Society)

Approved by AICTE, New Delhi & Affiliated to JNTUH, Hyderabad.

Kondapur (V), Ghatkesar (M), Medchal - Malkajgiri (D) - 501 301

Accredited By



NATIONAL BOARD OF ACCREDITATION

CSE & ECE

## CERTIFICATE OF PARTICIPATION

This is to certify that Mr./Ms./Mrs. G. Ganesh Reddy  
of ECE, Vignans Institute of Management and Technology for Women  
has participated in a Seminar on "Research and Innovation" held on 31-08-2021,  
Organized by IQAC, Vignans Institute of Management and Technology for Women.



  
Co-ordinator  
**Co-ordinator IQAC**  
Vignans Institute of Management and Technology for Women  
Kondapur (V), Ghatkesar (M), Medchal-Malkajgiri (D)-501301



PRINCIPAL

Vignans Institute of Management & Technology for Women  
Kondapur (V), Ghatkesar (M), Medchal-Malkajgiri (D)-501301

Telangana State

  
PRINCIPAL  
**Principal IQAC**  
Vignans Institute of Management & Technology for Women  
Kondapur (V), Ghatkesar (M), Medchal-Malkajgiri (D)-501301  
Telangana State



# VIGNAN'S INSTITUTE OF MANAGEMENT AND TECHNOLOGY FOR WOMEN

(Sponsored by Lavu Educational Society)  
Approved by AICTE, New Delhi & Affiliated to JNTUH, Hyderabad.  
Kondapur (V), Ghatkesar (M), Medchal - Malkajgiri (D) - 501 301

Accredited By



CSE & ECE

## CERTIFICATE OF PARTICIPATION

This is to certify that Mr./Ms./Mrs. Karthikapal Maddikunta  
of ECE, Vignans Institute of Management and Technology for Women  
has participated in a Seminar on "Research and Innovation" held on **31-08-2021**,  
Organized by IQAC, Vignans Institute of Management and Technology for Women.



*[Signature]*  
Co-ordinator  
Quality Assurance Cell  
IQAC  
Vignans Institute of Management and Technology for Women  
Kondapur (V), Ghatkesar (M), Medchal-Malkajgiri (D)-501301

*[Signature]*  
PRINCIPAL  
Vignans Institute of Management & Technology For Women  
Kondapur(V), Ghatkesar(M), Medchal-Malkajgiri(D)-501301  
Telangana State

*[Signature]*  
PRINCIPAL  
Vignans Institute of Management & Technology For Women  
Kondapur(V), Ghatkesar(M), Medchal-Malkajgiri(D)-501301  
Telangana State



# VIGNAN'S INSTITUTE OF MANAGEMENT AND TECHNOLOGY FOR WOMEN

(Sponsored by Lavu Educational Society)

Approved by AICTE, New Delhi & Affiliated to JNTUH, Hyderabad.

Kondapur (V), Ghatkesar (M), Medchal - Malkajgiri (D) - 501 301

Accredited By



CSE & ECE

## CERTIFICATE OF PARTICIPATION

This is to certify that Mr./Ms./Mrs. Nagaraju Eduru  
of ECE, Vignans Institute of Management and Technology for Women  
has participated in a Seminar on "Research and Innovation" held on **31-08-2021**,  
Organized by IQAC, Vignans Institute of Management and Technology for Women.



 Co-ordinator  
**Co-ordinator, IQAC**  
Vignans Institute of Management and Technology for Women  
Kondapur (V), Ghatkesar (M), Medchal-Malkajgiri (D)-501301

 PRINCIPAL

Vignans Institute of Management & Technology for Women  
Kondapur(V), Ghatkesar(M), Medchal-Malkajgiri(D)-501301  
Telangana State

 PRINCIPAL  
**Principal**  
Vignans Institute of Management & Technology for Women  
Kondapur(V), Ghatkesar(M), Medchal-Malkajgiri(D)-501301  
Telangana State



# VIGNAN'S INSTITUTE OF MANAGEMENT AND TECHNOLOGY FOR WOMEN

(Sponsored by Lavu Educational Society)

Approved by AICTE, New Delhi & Affiliated to JNTUH, Hyderabad.

Kondapur (V), Ghatkesar (M), Medchal - Malkajgiri (D) - 501 301

Accredited By



CSE & ECE

## CERTIFICATE OF PARTICIPATION

This is to certify that Mr./Ms./Mrs. Gangula Swathi

of ECE, Vignans Institute of Management and Technology for Women

has participated in a Seminar on "Research and Innovation" held on 31-08-2021,  
Organized by IQAC, Vignans Institute of Management and Technology for Women.



 Co-ordinator  
**Co-ordinator IQAC**  
Vignans Institute of Management and Technology for Women  
Kondapur (V), Ghatkesar (M), Medchal-Malkajgiri (D)-501301

 PRINCIPAL

Vignans Institute of Management & Technology for Women  
Kondapur(V), Ghatkesar(M), Medchal-Malkajgiri(D)-501301  
Telangana State

 PRINCIPAL  
**Principal**  
Vignans Institute of Management & Technology for Women  
Kondapur(V), Ghatkesar(M), Medchal-Malkajgiri(D)-501301  
Telangana State





# VIGNAN'S INSTITUTE OF MANAGEMENT AND TECHNOLOGY FOR WOMEN

(Sponsored by Lavu Educational Society)

Approved by AICTE, New Delhi & Affiliated to JNTUH, Hyderabad.

Kondapur (V), Ghatkesar (M), Medchal - Malkajgiri (D) - 501 301

Accredited By



CSE & ECE

## CERTIFICATE OF PARTICIPATION

This is to certify that Mr./Ms./Mrs. Vinod Kumar Bijuvala  
of ECE, Vignans Institute of Management and Technology for Women  
has participated in a Seminar on "Research and Innovation" held on **31-08-2021**,  
Organized by IQAC, Vignans Institute of Management and Technology for Women.



*[Signature]*  
Co-ordinator  
Quality Assurance Cell  
IQAC  
Vignans Institute of Management and Technology For Women  
Kondapur (V), Ghatkesar (M), Medchal-Malkajgiri (D)-501301

*[Signature]*  
PRINCIPAL

Vignans Institute of Management & Technology For Women  
Kondapur(V), Ghatkesar(M), Medchal-Malkajgiri(D)-501301  
Telangana State

*[Signature]*  
PRINCIPAL  
Vignans Institute of Management & Technology For Women  
Kondapur(V), Ghatkesar(M), Medchal-Malkajgiri(D)-501301  
Telangana State



# VIGNAN'S INSTITUTE OF MANAGEMENT AND TECHNOLOGY FOR WOMEN

(Sponsored by Lavu Educational Society)

Approved by AICTE, New Delhi & Affiliated to JNTUH, Hyderabad.

Kondapur (V), Ghatkesar (M), Medchal - Malkajgiri (D) - 501 301

Accredited By



NATIONAL BOARD OF ACCREDITATION

GSE & ECE

## CERTIFICATE OF PARTICIPATION

This is to certify that Mr./Ms./Mrs. Narendra Gali  
of ECE, Vignans Institute of Management and Technology for Women  
has participated in a Seminar on "Research and Innovation" held on 31-08-2021,  
Organized by IQAC, Vignans Institute of Management and Technology for Women.



  
Co-ordinator  
Quality Assurance Cell  
IQAC  
Vignans Institute of Management & Technology for Women  
Kondapur (V), Ghatkesar (M), Medchal-Malkajgiri (D)-501301  
Telangana State



PRINCIPAL

Vignans Institute of Management & Technology for Women  
Kondapur(V), Ghatkesar(M), Medchal-Malkajgiri(D)-501301  
Telangana State

  
PRINCIPAL  
Vignans Institute of Management & Technology for Women  
Kondapur(V), Ghatkesar(M), Medchal-Malkajgiri(D)-501301  
Telangana State



# VIGNAN'S INSTITUTE OF MANAGEMENT AND TECHNOLOGY FOR WOMEN

(Sponsored by Lavu Educational Society)

Approved by AICTE, New Delhi & Affiliated to JNTUH, Hyderabad.

Kondapur (V), Ghatkesar (M), Medchal - Malkajgiri (D) - 501 301

Accredited By



NATIONAL BOARD OF ACCREDITATION

CSE & ECE

## CERTIFICATE OF PARTICIPATION

This is to certify that Mr.AMs./Mrs. Usharani Narasingam  
of ECE, Vignans Institute of Management and Technology for Women

has participated in a Seminar on "Research and Innovation" held on 31-08-2021,  
Organized by IQAC, Vignans Institute of Management and Technology for Women.



*Usharani*

PRINCIPAL

Vignans Institute of Management & Technology for Women  
Kondapur(V), Ghatkesar(M), Medchal-Malkajgiri(D)-501301  
Telangana State

*Usharani* Co-ordinator

Co-ordinator Quality Assurance Cell

**IQAC**  
Vignans Institute of Management & Technology for Women  
Kondapur (V), Ghatkesar (M), Medchal-Malkajgiri (D)-501301  
Telangana State

*Usharani*

PRINCIPAL

Vignans Institute of Management & Technology for Women  
Kondapur(V), Ghatkesar(M), Medchal-Malkajgiri(D)-501301  
Telangana State



# VIGNAN'S INSTITUTE OF MANAGEMENT AND TECHNOLOGY FOR WOMEN

(Sponsored by Lavu Educational Society)

Approved by AICTE, New Delhi & Affiliated to JNTUH, Hyderabad.

Kondapur (M), Ghatkesar (M), Medchal - Malkajgiri (D) - 501 301

Accredited By



CSE & ECE

## CERTIFICATE OF PARTICIPATION

This is to certify that Mr./Ms./Mrs. Udaya Sri Bondi  
of ECE, Vignans Institute of Management and Technology for Women  
has participated in a Seminar on "Research and Innovation" held on **31-08-2021**,  
Organized by IQAC, Vignans Institute of Management and Technology for Women.



*Prash*  
PRINCIPAL

Vignans Institute of Management & Technology for Women  
Kondapur (M), Ghatkesar (M), Medchal-Malkajgiri (D) - 501301  
Telangana State

*[Signature]* Co-ordinator  
**Co-ordinator IQAC**  
Vignans Institute of Management & Technology For Women  
Kondapur (M), Ghatkesar (M), Medchal-Malkajgiri (D) - 501301  
Telangana State

*[Signature]*  
PRINCIPAL  
**Principal**  
Vignans Institute of Management & Technology for Women  
Kondapur (M), Ghatkesar (M), Medchal-Malkajgiri (D) - 501301  
Telangana State



# VIGNAN'S INSTITUTE OF MANAGEMENT AND TECHNOLOGY FOR WOMEN

(Sponsored by Lavu Educational Society)

Approved by AICTE, New Delhi & Affiliated to JNTUH, Hyderabad.

Kondapur (V), Ghatkesar (M), Medchal - Malkajgiri (D) - 501 301

Accredited By



**CSE & ECE**

## CERTIFICATE OF PARTICIPATION

This is to certify that Mr./Ms./Mrs. Naresh Chunchu  
of ECE, Vignan's Institute of Management and Technology for Women.

has participated in a Seminar on "Research and Innovation" held on **31-08-2021**,  
Organized by IQAC, Vignan's Institute of Management and Technology for Women.



 Co-ordinator  
**Co-ordinator IQAC**  
Vignan's Institute of Management and Technology for Women  
Kondapur (V), Ghatkesar (M), Medchal-Malkajgiri (D)-501301  
Telangana State

 PRINCIPAL  
Vignan's Institute of Management & Technology for Women  
Kondapur (V), Ghatkesar (M), Medchal-Malkajgiri (D)-501301  
Telangana State

 PRINCIPAL  
Vignan's Institute of Management & Technology for Women  
Kondapur (V), Ghatkesar (M), Medchal-Malkajgiri (D)-501301  
Telangana State



# VIGNAN'S INSTITUTE OF MANAGEMENT AND TECHNOLOGY FOR WOMEN

(Sponsored by Lavu Educational Society)

Approved by AICTE, New Delhi & Affiliated to JNTUH, Hyderabad.

Kondapur (V), Ghatkesar (M), Medchal - Malkajgiri (D) - 501 301

Accredited By



CSE & ECE

## CERTIFICATE OF PARTICIPATION

This is to certify that Mr./Mrs. Kiran Kumar Shankar  
of EEE, Vignans Institute of Management and Technology for Women  
has participated in a Seminar on "Research and Innovation" held on 31-08-2021,  
Organized by IQAC, Vignans Institute of Management and Technology for Women.



 Co-ordinator  
**Co-ordinator IQAC**  
Vignans Institute of Management and Technology for Women  
Kondapur (V), Ghatkesar (M), Medchal-Malkajgiri (D)-501301



PRINCIPAL  
Vignans Institute of Management & Technology For Women  
Kondapur(V), Ghatkesar(M), Medchal-Malkajgiri(D)-501301  
Telangana State

  
PRINCIPAL  
Vignans Institute of Management & Technology For Women  
Kondapur(V), Ghatkesar(M), Medchal-Malkajgiri(D)-501301  
Telangana State



# VIGNAN'S INSTITUTE OF MANAGEMENT AND TECHNOLOGY FOR WOMEN

(Sponsored by Lavu Educational Society)

Approved by AICTE, New Delhi & Affiliated to JNTUH, Hyderabad.

Kondapur (V), Ghatkesar (M), Medchal - Malkajgiri (D) - 501 301

Accredited By



CSE & ECE

## CERTIFICATE OF PARTICIPATION

This is to certify that Mr./Ms./Mrs. M. Sudheer Kumar  
of EEE, Vignans Institute of Management and Technology for Women  
has participated in a Seminar on "Research and Innovation" held on 31-08-2021,  
Organized by IQAC, Vignans Institute of Management and Technology for Women.



  
Co-ordinator  
**Co-ordinator IQAC**  
Vignans Institute of Management and Technology for Women  
Kondapur (V), Ghatkesar (M), Medchal-Malkajgiri (D) - 501 301



PRINCIPAL  
Vignans Institute of Management & Technology for Women  
Kondapur(V), Ghatkesar(M), Medchal-Malkajgiri(D)-501301  
Telangana State

  
PRINCIPAL  
Vignans Institute of Management & Technology for Women  
Kondapur(V), Ghatkesar(M), Medchal-Malkajgiri(D)-501301  
Telangana State



# VIGNAN'S INSTITUTE OF MANAGEMENT AND TECHNOLOGY FOR WOMEN

(Sponsored by Lavu Educational Society)

Approved by AICTE, New Delhi & Affiliated to JNTUH, Hyderabad.

Kondapur (V), Ghatkesar (M), Medchal - Malkajgiri (D) - 501 301

Accredited By



CSE & ECE

## CERTIFICATE OF PARTICIPATION

This is to certify that Mr./Ms./Mrs. / Dr. B. Shrinivasa Kumar  
of CSE, Vignans Institute of Management and Technology for Women

has participated in a Seminar on "Research and Innovation" held on 31-08-2021,  
Organized by IQAC, Vignans Institute of Management and Technology for Women.



 Co-ordinator  
**Co-ordinator IQAC**  
Vignans Institute of Management and Technology for Women  
Kondapur (V), Ghatkesar (M), Medchal-Malkajgiri (D)-501301  
Telangana State



PRINCIPAL  
Vignans Institute of Management & Technology for Women  
Kondapur (V), Ghatkesar (M), Medchal-Malkajgiri (D)-501301  
Telangana State

 PRINCIPAL  
Vignans Institute of Management & Technology for Women  
Kondapur (V), Ghatkesar (M), Medchal-Malkajgiri (D)-501301  
Telangana State





# VIGNAN'S INSTITUTE OF MANAGEMENT AND TECHNOLOGY FOR WOMEN

(Sponsored by Lavu Educational Society)

Approved by AICTE, New Delhi & Affiliated to JNTUH, Hyderabad.

Kondapur (M), Ghatkesar (M), Medchal - Malkajgiri (D) - 501 301

Accredited By



NATIONAL BOARD OF ACCREDITATION

CSE & ECE

## CERTIFICATE OF PARTICIPATION

This is to certify that Mr./Ms./Mrs./Dr. S. Ranga Swanup  
of CSE, Vignan's Institute of Management and Technology for Women  
has participated in a Seminar on "Research and Innovation" held on 31-08-2021,  
Organized by IQAC, Vignan's Institute of Management and Technology for Women.



*[Signature]*  
Co-ordinator  
**Co-ordinator IQAC**  
Vignan's Institute of Management and Technology for Women  
Kondapur (M), Ghatkesar (M), Medchal-Malkajgiri (D)-501301

*[Signature]*

PRINCIPAL  
Vignan's Institute of Management & Technology For Women  
Kondapur(M), Ghatkesar(M), Medchal-Malkajgiri(D)-501301  
Telangana State

*[Signature]*  
PRINCIPAL  
Vignan's Institute of Management & Technology For Women  
Kondapur(M), Ghatkesar(M), Medchal-Malkajgiri(D)-501301  
Telangana State



# VIGNAN'S INSTITUTE OF MANAGEMENT AND TECHNOLOGY FOR WOMEN



(Sponsored by Lavu Educational Society)  
Approved by AICTE, New Delhi & Affiliated to JNTUH, Hyderabad.  
Kondapur (V), Ghatkesar (M), Medchal - Malkajgiri (D) - 501 301

## CERTIFICATE OF PARTICIPATION

This is to certify that Mr./Ms./Mrs./Dr. A. Sudhir Babu  
of CSE, Vignans Institute of Management and Technology for Women  
has participated in a Seminar on "Research and Innovation" held on 31-08-2021,  
Organized by IQAC, Vignans Institute of Management and Technology for Women.



*[Signature]*  
Co-ordinator  
IQAC  
Vignans Institute of Management and Technology for Women  
Kondapur (V), Ghatkesar (M), Medchal-Malkajgiri (D) - 501 301

*[Signature]*  
PRINCIPAL  
Vignans Institute of Management & Technology For Women  
Kondapur (V), Ghatkesar (M), Medchal-Malkajgiri (D) - 501 301  
Telangana State

*[Signature]*  
PRINCIPAL  
Vignans Institute of Management & Technology For Women  
Kondapur (V), Ghatkesar (M), Medchal-Malkajgiri (D) - 501 301  
Telangana State



# VIGNAN'S INSTITUTE OF MANAGEMENT AND TECHNOLOGY FOR WOMEN

(Sponsored by Lavu Educational Society)

Approved by AICTE, New Delhi & Affiliated to JNTUH, Hyderabad.

Kondapur (V), Ghatkesar (M), Medchal - Malkajgiri (D) - 501 301

Accredited By



NATIONAL BOARD OF ACCREDITATION

CSE & ECE

## CERTIFICATE OF PARTICIPATION

This is to certify that Mr./Ms./Mrs. Dr. Ch. Basava Raj  
of CSE, Vignans Institute of Management and Technology for Women  
has participated in a Seminar on "Research and Innovation" held on 31-08-2021,  
Organized by IQAC, Vignans Institute of Management and Technology for Women.



  
Co-ordinator  
**Co-ordinator IQAC**  
Vignans Institute of Management and Technology for Women  
Kondapur (V), Ghatkesar (M), Medchal - Malkajgiri (D) - 501 301

  
Principal

Vignans Institute of Management & Technology for Women  
Kondapur (V), Ghatkesar (M), Medchal - Malkajgiri (D) - 501301  
Telangana State

  
PRINCIPAL  
**Principal**  
Vignans Institute of Management & Technology for Women  
Kondapur (V), Ghatkesar (M), Medchal - Malkajgiri (D) - 501301  
Telangana State



# VIGNAN'S INSTITUTE OF MANAGEMENT AND TECHNOLOGY FOR WOMEN

(Sponsored by Lavu Educational Society)

Approved by AICTE, New Delhi & Affiliated to JNTUH, Hyderabad.

Kondapur (V), Ghatkesar (M), Medchal - Malkajgiri (D) - 501 301

Accredited By



**CSE & ECE**

## CERTIFICATE OF PARTICIPATION

This is to certify that Mr./Ms./Mrs. Andromi Vasireddy  
of CSE, Vignans Institute of Management and Technology for Women  
has participated in a Seminar on "Research and Innovation" held on **31-08-2021**,  
Organized by IQAC, Vignans Institute of Management and Technology for Women.



  
Co-ordinator  
IQAC  
Vignans Institute of Management and Technology for Women  
Kondapur (V), Ghatkesar (M), Medchal-Malkajgiri (D) - 501301

  
PRINCIPAL

Vignans Institute of Management & Technology for Women  
Kondapur(V), Ghatkesar(M), Medchal-Malkajgiri(D)-501301  
Telangana State

  
PRINCIPAL  
Vignans Institute of Management & Technology for Women  
Kondapur(V), Ghatkesar(M), Medchal-Malkajgiri(D)-501301  
Telangana State



# VIGNAN'S INSTITUTE OF MANAGEMENT AND TECHNOLOGY FOR WOMEN

(Sponsored by Lavu Educational Society)

Approved by AICTE, New Delhi & Affiliated to JNTUH, Hyderabad.

Kondapur (V), Ghatkesar (M), Medchal - Malkajgiri (D) - 501 301

Accredited By



CSE & ECE

## CERTIFICATE OF PARTICIPATION

This is to certify that Mr./Ms./Mrs. Vishnu Vardhana Rao Marom  
of CSE, Vignan's Institute of Management and Technology for Women

has participated in a Seminar on "Research and Innovation" held on **31-08-2021**,  
Organized by IQAC, Vignan's Institute of Management and Technology for Women.



*Prin*  
PRINCIPAL

Vignan's Institute of Management & Technology For Women  
Kondapur(V), Ghatkesar(M), Medchal-Malkajgiri(D)-501301  
Telangana State

*[Signature]*  
Co-ordinator

**Co-ordinator IQAC**  
Vignan's Institute of Management & Technology For Women  
Kondapur(V), Ghatkesar (M), Medchal-Malkajgiri (D)-501301  
Telangana State

*[Signature]*  
PRINCIPAL  
Vignan's Institute of Management & Technology For Women  
Kondapur(V), Ghatkesar(M), Medchal-Malkajgiri(D)-501301  
Telangana State



# VIGNAN'S INSTITUTE OF MANAGEMENT AND TECHNOLOGY FOR WOMEN

(Sponsored by Lavu Educational Society)

Approved by AICTE, New Delhi & Affiliated to JNTUH, Hyderabad.

Kondapur (V), Ghatkesar (M), Medchal - Malkajgiri (D) - 501 301

Accredited By



CSE & ECE

## CERTIFICATE OF PARTICIPATION

This is to certify that Mr./Ms./Mrs. Rajendra Prasad Panaganti  
of CSE, Vignan's Institute of Management and Technology for Women  
has participated in a Seminar on "Research and Innovation" held on **31-08-2021**,  
Organized by IQAC, Vignan's Institute of Management and Technology for Women.



*[Signature]*  
PRINCIPAL

Vignan's Institute of Management & Technology For Women  
Kondapur(V), Ghatkesar(M), Medchal-Malkajgiri(D)-501301  
Telangana State

*[Signature]* Co-ordinator  
**Co-ordinator IQAC**  
Vignan's Institute of Management & Technology For Women  
Kondapur (V), Ghatkesar (M), Medchal-Malkajgiri (D)-501301

*[Signature]* PRINCIPAL  
**Principal IQAC**  
Vignan's Institute of Management & Technology For Women  
Kondapur(V), Ghatkesar(M), Medchal-Malkajgiri(D)-501301  
Telangana State



# VIGNAN'S INSTITUTE OF MANAGEMENT AND TECHNOLOGY FOR WOMEN

(Sponsored by Lavu Educational Society)

Approved by AICTE, New Delhi & Affiliated to JNTUH, Hyderabad.

Kondapur (V), Ghatkesar (M), Medchal - Malkajgiri (D) - 501 301

Accredited By



CSE & ECE

## CERTIFICATE OF PARTICIPATION

This is to certify that Mr./Ms./Mrs. *Lavi Surarapu*  
of *CSE, Vignan's Institute of Management and Technology for Women*

has participated in a Seminar on "Research and Innovation" held on 31-08-2021,  
Organized by IQAC, Vignan's Institute of Management and Technology for Women.



*A. J. S.* Co-ordinator  
Co-ordinator IQAC  
Vignan's Institute of Management and Technology for Women  
Kondapur (V), Ghatkesar (M), Medchal - Malkajgiri (D) - 501301  
Telangana State

*RAJAN*

PRINCIPAL

Vignan's Institute of Management & Technology For Women  
Kondapur(V), Ghatkesar(M), Medchal-Malkajgiri(D)-501301  
Telangana State

*RAJAN* PRINCIPAL  
Vignan's Institute of Management & Technology For Women  
Kondapur(V), Ghatkesar(M), Medchal-Malkajgiri(D)-501301  
Telangana State



# VIGNAN'S INSTITUTE OF MANAGEMENT AND TECHNOLOGY FOR WOMEN

(Sponsored by Lavu Educational Society)

Approved by AICTE, New Delhi & Affiliated to JNTUH, Hyderabad.

Kondapur (V), Ghatkesar (M), Medchal - Malkajgiri (D) - 501 301

Accredited By



CSE & ECE

## CERTIFICATE OF PARTICIPATION

This is to certify that Mr./Ms./Mrs. Bhavani Geetha  
of CSE, Vignan's Institute of Management and Technology for Women  
has participated in a Seminar on "Research and Innovation" held on **31-08-2021**,  
Organized by IQAC, Vignan's Institute of Management and Technology for Women.



  
Co-ordinator  
**Co-ordinator IQAC**  
Vignan's Institute of Management & Technology For Women  
Kondapur (V), Ghatkesar (M), Medchal-Malkajgiri (D) - 501301  
Telangana State

  
PRINCIPAL

Vignan's Institute of Management & Technology For Women  
Kondapur(V), Ghatkesar(M), Medchal-Malkajgiri(D)-501301  
Telangana State

  
PRINCIPAL  
**Principal IQAC**  
Vignan's Institute of Management & Technology For Women  
Kondapur(V), Ghatkesar(M), Medchal-Malkajgiri(D)-501301  
Telangana State





# VIGNAN'S INSTITUTE OF MANAGEMENT AND TECHNOLOGY FOR WOMEN

(Sponsored by Lavu Educational Society)

Approved by AICTE, New Delhi & Affiliated to JNTUH, Hyderabad.

Kondapur (V), Ghatkesar (M), Medchal - Malkajgiri (D) - 501 301

Accredited By



NATIONAL BOARD OF ACCREDITATION

CSE & ECE

## CERTIFICATE OF PARTICIPATION

This is to certify that Mr./Ms./Mrs. Ch. Sunil  
of CSE, Vignans Institute of Management and Technology for Women  
has participated in a Seminar on "Research and Innovation" held on 31-08-2021,  
Organized by IQAC, Vignans Institute of Management and Technology for Women.



*[Signature]*  
Co-ordinator  
Assurance Cell  
**IQAC**  
Vignans Institute of Management and Technology for Women  
Kondapur (V), Ghatkesar (M), Medchal-Malkajgiri (D)-501301

*[Signature]*

PRINCIPAL

Vignans Institute of Management & Technology For Women  
Kondapur(V), Ghatkesar(M), Medchal-Malkajgiri(D)-501301  
Telangana State

*[Signature]*  
PRINCIPAL  
Vignans Institute of Management & Technology For Women  
Kondapur(V), Ghatkesar(M), Medchal-Malkajgiri(D)-501301  
Telangana State



# VIGNAN'S INSTITUTE OF MANAGEMENT AND TECHNOLOGY FOR WOMEN

(Sponsored by Lavu Educational Society)

Approved by AICTE, New Delhi & Affiliated to JNTUH, Hyderabad.

Kondapur (V), Ghatkesar (M), Medchal - Malkajgiri (D) - 501 301

Accredited By



CSE & ECE

## CERTIFICATE OF PARTICIPATION

This is to certify that Mr./Mrs. K. Prathyusha  
of CSE, Vignan's Institute of Management and Technology for Women  
has participated in a Seminar on "Research and Innovation" held on 31-08-2021,  
Organized by IQAC, Vignan's Institute of Management and Technology for Women.



  
Co-ordinator  
Assurance Cell  
IQAC  
Vignan's Institute of Management and Technology for Women  
Kondapur (V), Ghatkesar (M), Medchal-Malkajgiri (D) - 501301

  
PRINCIPAL

Vignan's Institute of Management & Technology for Women  
Kondapur(V), Ghatkesar(M), Medchal-Malkajgiri(D)-501301  
Telangana State

  
PRINCIPAL  
Vignan's Institute of Management & Technology for Women  
Kondapur(V), Ghatkesar(M), Medchal-Malkajgiri(D)-501301  
Telangana State



# VIGNAN'S INSTITUTE OF MANAGEMENT AND TECHNOLOGY FOR WOMEN

(Sponsored by Lavu Educational Society)

Approved by AICTE, New Delhi & Affiliated to JNTUH, Hyderabad.

Kondapur (V), Ghatkesar (M), Medchal - Malkajgiri (D) - 501 301

Accredited By



CSE & ECE

## CERTIFICATE OF PARTICIPATION

This is to certify that Mr./Ms./Mrs. H. Saisiva  
of CSE, Vignan's Institute of Management and Technology for Women  
has participated in a Seminar on "Research and Innovation" held on 31-08-2021,  
Organized by IQAC, Vignan's Institute of Management and Technology for Women.



 Co-ordinator  
**Co-ordinator IQAC**  
Vignan's Institute of Management & Technology For Women  
Kondapur (V), Ghatkesar (M), Medchal-Malkajgiri (D)-501301

  
PRINCIPAL  
Vignan's Institute of Management & Technology for Women  
Kondapur (V), Ghatkesar (M), Medchal-Malkajgiri (D)-501301  
Telangana State

  
PRINCIPAL  
Vignan's Institute of Management & Technology For Women  
Kondapur (V), Ghatkesar (M), Medchal-Malkajgiri (D)-501301  
Telangana State



# VIGNAN'S INSTITUTE OF MANAGEMENT AND TECHNOLOGY FOR WOMEN

(Sponsored by Lavu Educational Society)  
Approved by AICTE, New Delhi & Affiliated to JNTUH, Hyderabad.

Kondapur (V), Ghatkesar (M), Medchal - Malkajgiri (D) - 501 301

Accredited By



NATIONAL BOARD OF ACCREDITATION

CSE & ECE

## CERTIFICATE OF PARTICIPATION

This is to certify that Mr./Ms./Mrs. S. Krishna Babu  
of CSE, Vignans Institute of Management and Technology for Women

has participated in a Seminar on "Research and Innovation" held on 31-08-2021,  
Organized by IQAC, Vignans Institute of Management and Technology for Women.



*Handwritten signature*

PRINCIPAL  
Vignans Institute of Management & Technology for Women  
Kondapur(V), Ghatkesar(M), Medchal-Malkajgiri(D)-501301  
Telangana State

*Handwritten signature*  
Co-ordinator  
Co-ordinator IQAC  
Vignans Institute of Management & Technology for Women  
Kondapur(V), Ghatkesar(M), Medchal-Malkajgiri(D)-501301  
Telangana State

*Handwritten signature*  
PRINCIPAL  
Vignans Institute of Management & Technology for Women  
Kondapur(V), Ghatkesar(M), Medchal-Malkajgiri(D)-501301  
Telangana State



# VIGNAN'S INSTITUTE OF MANAGEMENT AND TECHNOLOGY FOR WOMEN

(Sponsored by Lavu Educational Society)

Approved by AICTE, New Delhi & Affiliated to JNTUH, Hyderabad.

Kondapur (V), Ghatkesar (M), Medchal - Malkajgiri (D) - 501 301

Accredited By



## CERTIFICATE OF PARTICIPATION

This is to certify that Mr./Ms./Mrs. S. Sandeep Babar  
of CSE, Vignans Institute of Management and Technology for Women  
has participated in a Seminar on "Research and Innovation" held on 31-08-2021,  
Organized by IQAC, Vignans Institute of Management and Technology for Women.



*Prakash*

PRINCIPAL  
Vignans Institute of Management & Technology for Women  
Kondapur(V), Ghatkesar(M), Medchal-Malkajgiri(D)-501301  
Telangana State

*[Signature]* Co-ordinator  
Co-ordinator IQAC  
Vignans Institute of Management and Technology for Women  
Kondapur (V), Ghatkesar (M), Medchal-Malkajgiri (D)-501301  
Telangana State

*[Signature]* PRINCIPAL  
Vignans Institute of Management & Technology for Women  
Kondapur(V), Ghatkesar(M), Medchal-Malkajgiri(D)-501301  
Telangana State



# VIGNAN'S INSTITUTE OF MANAGEMENT AND TECHNOLOGY FOR WOMEN

(Sponsored by Lavu Educational Society)

Approved by AICTE, New Delhi & Affiliated to JNTUH, Hyderabad.

Kondapur (M), Ghatkesar (M), Medchal - Malkajgiri (D) - 501 301

Accredited By



NATIONAL BOARD OF ACCREDITATION

CSE & ECE

## CERTIFICATE OF PARTICIPATION

This is to certify that Mr./Ms./Mrs. Sathini Santosh Kumar  
of CSE, Vignan's Institute of Management and Technology for Women

has participated in a Seminar on "Research and Innovation" held on 31-08-2021,  
Organized by IQAC, Vignan's Institute of Management and Technology for Women.



  
Co-ordinator  
**Co-ordinator, IQAC**  
Assurance Cell  
Vignan's Institute of Management and Technology for Women  
Kondapur (M), Ghatkesar (M), Medchal - Malkajgiri (D) - 501 301

*Handwritten signature*

Principal  
Vignan's Institute of Management and Technology for Women  
Kondapur (M), Ghatkesar (M), Medchal - Malkajgiri (D) - 501 301  
Telangana State

  
PRINCIPAL  
**Principal**  
Vignan's Institute of Management and Technology for Women  
Kondapur (M), Ghatkesar (M), Medchal - Malkajgiri (D) - 501 301  
Telangana State



# VIGNAN'S INSTITUTE OF MANAGEMENT AND TECHNOLOGY FOR WOMEN

(Sponsored by Lavu Educational Society)

Approved by AICTE, New Delhi & Affiliated to JNTUH, Hyderabad.

Kondapur (V), Ghatkesar (M), Medchal - Malkajgiri (D) - 501 301

Accredited By



CSE & ECE

## CERTIFICATE OF PARTICIPATION

This is to certify that Mr./Ms./Mrs. Venkat Rao Abbala  
of CSE, Vignans Institute of Management and Technology for Women

has participated in a Seminar on "Research and Innovation" held on 31-08-2021,

Organized by IQAC, Vignans Institute of Management and Technology for Women.



[Signature] Co-ordinator  
**Co-ordinator IQAC**  
Vignans Institute of Management and Technology for Women  
Ghatkesar (M), Medchal-Malkajgiri (D) - 501301

[Signature]  
PRINCIPAL  
Vignans Institute of Management & Technology for Women  
Kondapur(V), Ghatkesar(M), Medchal-Malkajgiri(D) - 501301

[Signature]  
PRINCIPAL  
Vignans Institute of Management & Technology for Women  
Kondapur(V), Ghatkesar(M), Medchal-Malkajgiri(D) - 501301  
Telangana State



# VIGNAN'S INSTITUTE OF MANAGEMENT AND TECHNOLOGY FOR WOMEN

(Sponsored by Lavu Educational Society)

Approved by AICTE, New Delhi & Affiliated to JNTUH, Hyderabad.

Kondapur (V), Ghatkesar (M), Medchal - Malkajgiri (D) - 501 301

Accredited By

**NBA**  
NATIONAL BOARD  
of ACCREDITATION

**CSE & ECE**

## CERTIFICATE OF PARTICIPATION

This is to certify that Mr./Ms./Mrs. M. Uday Kumar  
of CSE, Vignans Institute of Management and Technology for Women  
has participated in a Seminar on "Research and Innovation" held on 31-08-2021,  
Organized by IQAC, Vignans Institute of Management and Technology for Women.



  
Co-ordinator  
**IQAC**  
Vignans Institute of Management and Technology for Women  
Kondapur (V), Ghatkesar (M), Medchal-Malkajgiri (D) - 501301

  
PRINCIPAL

Vignans Institute of Management & Technology For Women  
Kondapur(V), Ghatkesar(M), Medchal-Malkajgiri(D) - 501 301  
Telangana State

  
PRINCIPAL  
Vignans Institute of Management & Technology For Women  
Kondapur(V), Ghatkesar(M), Medchal-Malkajgiri(D) - 501301  
Telangana State





# VIGNAN'S INSTITUTE OF MANAGEMENT AND TECHNOLOGY FOR WOMEN

(Sponsored by Lavu Educational Society)

Approved by AICTE, New Delhi & Affiliated to JNTUH, Hyderabad.

Kondapur (V), Ghatkesar (M), Medchal - Malkajgiri (D) - 501 301

Accredited By



GSE & ECE

## CERTIFICATE OF PARTICIPATION

This is to certify that Mr./Ms./Mrs. S. Dilhi Babu  
of CSE, Vignan's Institute of Management and Technology for Women  
has participated in a Seminar on "Research and Innovation" held on 31-08-2021,  
Organized by IQAC, Vignan's Institute of Management and Technology for Women.



*Handwritten signature*

Vignan's Institute of Management & Technology for Women  
Kondapur (V), Ghatkesar (M), Medchal - Malkajgiri (D) - 501301  
Telangana State

*Handwritten signature*

Principal/PRINCIPAL

Co-ordinator IQAC

*Handwritten signature*  
Co-ordinator IQAC  
Vignan's Institute of Management & Technology for Women  
Kondapur (V), Ghatkesar (M), Medchal - Malkajgiri (D) - 501301  
Telangana State

Vignan's Institute of Management & Technology for Women  
Kondapur (V), Ghatkesar (M), Medchal - Malkajgiri (D) - 501301



VIGNAN'S INSTITUTE OF MANAGEMENT AND TECHNOLOGY FOR WOMEN

# TECHNOLOGY FOR WOMEN

(Sponsored by Lavu Educational Society)

Approved by AICTE, New Delhi & Affiliated to JNTUH, Hyderabad.

Kondapur (V), Ghatkesar (M), Medchal - Malkajgiri (D) - 501 301

Accredited By



NATIONAL BOARD OF ACCREDITATION

CSE & ECE

## CERTIFICATE OF PARTICIPATION

This is to certify that Mr./Ms./Mrs. Hanay Bhusan Pillamari  
of CSE, Vignan's Institute of Management and Technology for Women

has participated in a Seminar on "Research and Innovation" held on **31-08-2021**,  
Organized by IQAC, Vignan's Institute of Management and Technology for Women.



*[Signature]*  
Co-ordinator  
Vignan's Institute of Management and Technology for Women  
Kondapur (V), Ghatkesar (M), Medchal - Malkajgiri (D) - 501 301

*[Signature]*  
PRINCIPAL

Vignan's Institute of Management & Technology for Women  
Kondapur (V), Ghatkesar (M), Medchal - Malkajgiri (D) - 501 301  
Telangana State

*[Signature]*

Principal

Vignan's Institute of Management & Technology for Women  
Kondapur (V), Ghatkesar (M), Medchal - Malkajgiri (D) - 501 301



VIGNAN'S INSTITUTE OF MANAGEMENT & TECHNOLOGY FOR WOMEN

# TECHNOLOGY FOR WOMEN

(Sponsored by Lavu Educational Society)

Approved by AICTE, New Delhi & Affiliated to JNTUH, Hyderabad.

Kondapur (V), Ghatkesar (M), Medchal - Malkajgiri (D) - 501 301



## CERTIFICATE OF PARTICIPATION

This is to certify that Mr./Ms./Mrs. Deep Shokhuri  
of B.S.H. Vignans Institute of Management and Technology for Women

has participated in a Seminar on "Research and Innovation" held on 31-08-2021,  
Organized by IQAC, Vignans Institute of Management and Technology for Women.



[Signature] Co-ordinator  
Vignans Institute of Management & Technology For Women  
Kondapur (V), Ghatkesar (M), Medchal - Malkajgiri (D) - 501 301  
Telangana State

**Co-ordinator IQAC**

[Signature]

Vignans Institute of Management & Technology For Women  
Kondapur (V), Ghatkesar (M), Medchal - Malkajgiri (D) - 501 301  
Telangana State

[Signature]

**Principal**

Vignans Institute of Management & Technology For Women  
Kondapur (V), Ghatkesar (M), Medchal - Malkajgiri (D) - 501 301  
Telangana State



**VIGNAN'S INSTITUTE OF MANAGEMENT & TECHNOLOGY FOR WOMEN**



**TECHNOLOGY FOR WOMEN**

(Sponsored by Lavu Educational Society)  
Approved by AICTE, New Delhi & Affiliated to JNTUH, Hyderabad.  
Kondapur (V), Ghatkesar (M), Medchal - Malkajgiri (D) - 501 301

**CERTIFICATE OF PARTICIPATION**

This is to certify that Mr./Ms./Mrs. Kavitha Danti  
of B.S.H. Vignans's Institute of Management and Technology for Women  
has participated in a Seminar on "Research and Innovation" held on **31-08-2021**,  
Organized by IQAC, Vignans's Institute of Management and Technology for Women.



**PRINCIPAL**  
Vignans's Institute of Management & Technology for Women  
Kondapur (V), Ghatkesar (M), Medchal - Malkajgiri (D) - 501 301  
Telangana State

**Principal/PRINCIPAL**

**Co-ordinator IQAC**  
Vignans's Institute of Management & Technology for Women  
Kondapur (V), Ghatkesar (M), Medchal - Malkajgiri (D) - 501 301  
Telangana State

Vignans's Institute of Management & Technology for Women  
Kondapur (V), Ghatkesar (M), Medchal - Malkajgiri (D) - 501 301



INSTITUTE OF MANAGEMENT AND

**TECHNOLOGY FOR WOMEN**

(Sponsored by Lavu Educational Society)

Approved by AICTE, New Delhi & Affiliated to JNTUH, Hyderabad.

Kondapur (V), Ghatkesar (M), Medchal - Malkajgiri (D) - 501 301

Accredited By

**NBA**

NATIONAL BOARD  
OF ACCREDITATION

**CSE & ECE**

## CERTIFICATE OF PARTICIPATION

This is to certify that Mr./Ms./Mrs. Santosh Kumar Kodam  
of B.S.H., Vignans Institute of Management and Technology for Women  
has participated in a Seminar on "Research and Innovation" held on **31-08-2021**,  
Organized by IQAC, Vignans Institute of Management and Technology for Women.



Co-ordinator

Cell for Quality Assurance & Technology For Women

**Co-ordinator, IQAC**

Vignans Institute of Management and Technology for Women  
Kondapur (V), Ghatkesar (M), Medchal - Malkajgiri (D) - 501301

PRINCIPAL

Vignans Institute of Management & Technology For Women  
Kondapur(V), Ghatkesar(M), Medchal-Malkajgiri(D)-501301  
Telangana State

**Principal**

Vignans Institute of Management & Technology For Women  
Kondapur(V), Ghatkesar(M), Medchal-Malkajgiri(D)-501301



VIGNA

# TECHNOLOGY FOR WOMEN

(Sponsored by Lavu Educational Society)

Approved by AICTE, New Delhi & Affiliated to JNTUH, Hyderabad.

Kondapur (V), Ghatkesar (M), Medchal - Malkajgiri (D) - 501 301

TECHNOLOGY FOR WOMEN AND

Recognized by



## CERTIFICATE OF PARTICIPATION

This is to certify that Mr./Ms./Mrs. Komareddy Bal Reddy  
of BSH, Vignan's Institute of Management and Technology for Women  
has participated in a Seminar on "Research and Innovation" held on 31-08-2021,  
Organized by IQAC, Vignan's Institute of Management and Technology for Women.



*[Signature]*  
Co-ordinator  
Vignan's Institute of Management and Technology for Women  
Kondapur (V), Ghatkesar (M), Medchal - Malkajgiri (D) - 501 301  
Telangana State

*[Signature]*  
PRINCIPAL

Vignan's Institute of Management & Technology For Women  
Kondapur(V), Ghatkesar(M), Medchal-Malkajgiri(D)-501301  
Telangana State

*[Signature]*

Principal

Vignan's Institute of Management & Technology For Women  
Kondapur(V), Ghatkesar(M), Medchal-Malkajgiri(D)-501301  
Telangana State



## TECHNOLOGY FOR WOMEN

(Sponsored by Lavu Educational Society)

Approved by AICTE, New Delhi & Affiliated to JNTUH, Hyderabad.

Kondapur (V), Ghatkesar (M), Medchal - Malkajgiri (D) - 501 301



# CERTIFICATE OF PARTICIPATION

This is to certify that Mr./Ms./Mrs. Maddi Swamy  
of BSH, Vignan's Institute of Management and Technology for Women  
has participated in a Seminar on "Research and Innovation" held on **31-08-2021**,  
Organized by IQAC, Vignan's Institute of Management and Technology for Women.



  
Co-ordinator  
Internal Quality Assurance Cell  
Vignan's Institute of Management & Technology For Women  
Kondapur (V), Ghatkesar (M), Medchal - Malkajgiri (D) - 501301  
Telangana State  
**Co-ordinator, IQAC**

  
Principal  
Vignan's Institute of Management & Technology For Women  
Kondapur (V), Ghatkesar (M), Medchal - Malkajgiri (D) - 501301  
Telangana State

**Principal**

Vignan's Institute of Management & Technology For Women  
Kondapur (V), Ghatkesar (M), Medchal - Malkajgiri (D) - 501301  
Telangana State



## TECHNOLOGY FOR WOMEN

(Sponsored by Lavu Educational Society)

Approved by AICTE, New Delhi & Affiliated to JNTUH, Hyderabad.

Kondapur (V), Ghatkesar (M), Medchal - Malkajgiri (D) - 501 301



# CERTIFICATE OF PARTICIPATION

This is to certify that Mr./Ms./Mrs. *A. Mallikarjuna*

of *B.S.H. Vignans Institute of Management and Technology for Women*

has participated in a Seminar on "Research and Innovation" held on 31-08-2021,  
Organized by IQAC, Vignans Institute of Management and Technology for Women.



*A. Mallikarjuna* Co-ordinator  
Internal Quality Assurance Cell  
Vignans Institute of Management & Technology for Women  
Kondapur (V), Ghatkesar (M), Medchal - Malkajgiri (D) - 501 301  
Telangana State  
**Co-ordinator, IQAC**

*A. Mallikarjuna*  
PRINCIPAL

Vignans Institute of Management & Technology for Women  
Kondapur (V), Ghatkesar (M), Medchal - Malkajgiri (D) - 501 301  
Telangana State

*A. Mallikarjuna*

**Principal**

Vignans Institute of Management & Technology for Women  
Kondapur (V), Ghatkesar (M), Medchal - Malkajgiri (D) - 501 301  
Telangana State





**INSTITUTE FOR WOMEN**

(Sponsored by Lavu Educational Society)

Approved by AICTE, New Delhi & Affiliated to JNTUH, Hyderabad.

**Kondapur (V), Ghatkesar (M), Medchal - Malkajgiri (D) - 501 301**



# CERTIFICATE OF PARTICIPATION

This is to certify that Mr./Ms./Mrs. R. Manjula  
of B.S.H. Vignan's Institute of Management and Technology for Women  
has participated in a Seminar on **"Research and Innovation"** held on **31-08-2021**,  
Organized by IQAC, Vignan's Institute of Management and Technology for Women.



*[Signature]*  
Co-ordinator  
Vignan's Institute of Management & Technology for Women  
Kondapur (V), Ghatkesar (M), Medchal - Malkajgiri (D) - 501 301  
Telangana State

*[Signature]*  
Vignan's Institute of Management & Technology for Women  
Kondapur (V), Ghatkesar (M), Medchal - Malkajgiri (D) - 501 301  
Telangana State

*[Signature]*  
Principal

**Principal**  
Vignan's Institute of Management & Technology for Women  
Kondapur (V), Ghatkesar (M), Medchal - Malkajgiri (D) - 501 301  
Telangana State



VIGNANS INSTITUTE OF MANAGEMENT AND TECHNOLOGY FOR WOMEN



INSTITUTE FOR WOMEN

(Sponsored by Lavu Educational Society)  
Approved by AICTE, New Delhi & Affiliated to JNTUH, Hyderabad.

Kondapur (V), Ghatkesar (M), Medchal - Malkajgiri (D) - 501 301

# CERTIFICATE OF PARTICIPATION

This is to certify that Mr./Ms./Mrs. J. Mohan Krishna  
of BSH, Vignans Institute of Management and Technology for Women  
has participated in a Seminar on "Research and Innovation" held on 31-08-2021,  
Organized by IQAC, Vignans Institute of Management and Technology for Women.



*IQAC*  
Vignans Institute of Management & Technology for Women  
Kondapur (V), Ghatkesar (M), Medchal - Malkajgiri (D) - 501 301  
Telangana State

*J. Mohan Krishna*  
Co-ordinator  
Vignans Institute of Management & Technology for Women  
Kondapur (V), Ghatkesar (M), Medchal - Malkajgiri (D) - 501 301  
Telangana State

*J. Mohan Krishna*

Principal  
Vignans Institute of Management & Technology for Women  
Kondapur (V), Ghatkesar (M), Medchal - Malkajgiri (D) - 501 301  
Telangana State



VIGNANS INSTITUTE OF MANAGEMENT AND  
**TECHNOLOGY FOR WOMEN**

(Sponsored by Lavu Educational Society)

Approved by AICTE, New Delhi & Affiliated to JNTUH, Hyderabad.

Kondapur (V), Ghatkesar (M), Medchal - Malkajgiri (D) - 501 301



**CERTIFICATE OF PARTICIPATION**

This is to certify that Mr./Ms./Mrs. Md. Khaleel Akter  
of B.S.H. Vignans Institute of Management and Technology for Women  
has participated in a Seminar on "Research and Innovation" held on **31-08-2021**,  
Organized by IQAC, Vignans Institute of Management and Technology for Women.



*[Signature]* Co-ordinator  
Internal Quality Assurance Cell  
Vignans Institute of Management & Technology for Women  
Kondapur (V), Ghatkesar (M), Medchal-Malkajgiri (D)-501301  
Telangana State  
**Co-ordinator, IQAC**

*[Signature]*  
Principal  
Vignans Institute of Management & Technology for Women  
Kondapur (V), Ghatkesar (M), Medchal-Malkajgiri (D)-501301  
Telangana State

**Principal**

Vignans Institute of Management & Technology for Women  
Kondapur (V), Ghatkesar (M), Medchal-Malkajgiri (D)-501301  
Telangana State



## TECHNOLOGY FOR WOMEN

(Sponsored by Lavu Educational Society)

Approved by AICTE, New Delhi & Affiliated to JNTUH, Hyderabad.

Kondapur (V), Ghatkesar (M), Medchal - Malkajgiri (D) - 501 301



# CERTIFICATE OF PARTICIPATION

This is to certify that Mr./Ms./Mrs. Syamshobhini Venum  
of B.S.H. Vignans's Institute of Management and Technology for Women  
has participated in a Seminar on "Research and Innovation" held on 31-08-2021,  
Organized by IQAC, Vignans's Institute of Management and Technology for Women.



  
Co-ordinator  
Vignans's Institute of Management & Technology for Women  
Kondapur (V), Ghatkesar (M), Medchal - Malkajgiri (D) - 501301  
Telangana State

  
PRINCIPAL  
Vignans's Institute of Management & Technology for Women  
Kondapur (V), Ghatkesar (M), Medchal - Malkajgiri (D) - 501301  
Telangana State



Principal

Vignans's Institute of Management & Technology for Women  
Kondapur (V), Ghatkesar (M), Medchal - Malkajgiri (D) - 501301  
Telangana State



## VIGNAN'S INSTITUTE OF MANAGEMENT AND TECHNOLOGY FOR WOMEN

(Sponsored by Lavu Educational Society)

Approved by AICTE, New Delhi & Affiliated to JNTUH, Hyderabad.

Kondapur (V), Ghatkesar (M), Medchal - Malkajgiri (D) - 501 301



# INTERNAL QUALITY ASSURANCE CELL (IQAC)

A Workshop On

# NAAC

## ACCREDITATION & ASSESSMENT

22-10-2022 @ 9:30 AM

Venue: Seminar Hall



Resource Person:  
**Dr. A. Mallikarjuna Reddy,**  
Associate Professor,  
Asuraj University, Hyderabad.

Chief Patron:  
**Dr. Lavu Rathaiah,**  
Chairman, Vignan-Group.

Patron:  
**Mr. B. Shravan,**  
CEO, Vignan Group.

Co-Patron:  
**Dr. G. Apparao Naidu,**  
Principal, VMTW.

Advisor:  
**Mr. G. Rajesh,**  
Co-Ordinator, IQAC.

Program Co-Ordinator:  
**Mr. B. Phijik,**  
Associate Professor & HOD,  
Department of IT,  
Cell: +91 96529 10002

Date: 20/10/22

To  
The Principal  
VMTW  
Ghatkesar, Hyd

Sub: Request for Permission to Conduct Workshop on NAAC Accreditation & Assessment

Respected Sir,

IQAC is planning to conduct a workshop on NAAC Accreditation & Assessment on 22/10/22 in our campus. The workshop aims to provide faculty members with valuable insights into the accreditation process and help them understand the requirements for achieving and maintaining accreditation.

So we request you to give Approval for conducting this FDP and sanction the required amount to organize the FDP.

We eagerly anticipate your favorable response, and we remain committed to upholding the highest standards of quality.

Thank you Sir

Yours Faithfully

  
Rajesh Gundla

Co-ordinator, IQAC



  
PRINCIPAL

Vignana's Institute of Management & Technology For Women  
Kondapur(V), Ghatkesar(M), Medchal-Malkajgiri(Dt)-501301  
Telangana State

**Dr. A. MALLIKARJUNA REDDY**  
**Associate Professor**  
**Dept. of CSE**  
**Anurag University, HYD.**

**Mobile Number: 8341222040**  
**mallikarjunreddycse@anurag.edu.in**



Dr. A. Mallikarjuna Reddy working as Assoc. Prof in CSE department, Anurag University, Have a total experience of 10 years in academics under various capacities. To his credit he has 1 patent, 2 Books, 20 Scopus, 25 UGC Journal Publications and also presented more than 10 papers in various international conferences. He also contributed as a speaker for various Faculty Development programmes on Teaching and Learning Practices. He is a Member of BoS, NAAC coordinator, IoT Research Wing Coordinator and also a member of various professional bodies like IAENG, CSTA, IFERP, IS & IRED. He is serving as active reviewer of peer reviewed international journals such as JEET and IFERP. He has been a part of Advisory Committee, Convener, Chair, Co-chair, Technical Program Committee and organizing committee member for various International and National conferences. His areas of interest are Digital Image Processing, Internet of Things, Data Science, Databases and Security. He Received Certificates from Coursera and NPTEL in various courses and currently doing Specialization courses on Machine Learning and Internet of Things.

### Education

- 2014-2019 PhD. in Computer Science and Engineering from Jawaharlal Nehru Technological University, Kakinada (JNTUK)
- 2008-2010 M.Tech (Computer Science and Engineering) from National Institute of Technology Calicut (NITC)
- 2003-2007 B.E. (Computer Science & Engineering) from Anna University, Tamilnadu.

### Patent

Dr. A. Mallikarjuna Reddy . IHY – Prediction: Intelligent system and method for advanced harvest yield prediction using IoT based technology . The Patent Office Journal No. 01/2020 Dated 03/01/2020.

### Books

1. Data Structure through C++ published by LAMBERT academic publishing, ISBN No: 978-613-998906-5, 2018.
2. Foundations of Database Management Systems Published by LAP academic publishing, ISBN No: 978-620-2-51548-1, 2020.



**PRINCIPAL**  
Vignaa's Institute of Management & Technology For Women  
Kondapur (V), Ghathkesar (M), Medchal-Malkajgiri (DI)-601301  
Telangana State

## International & National Conferences

1. Internet of Things (IoT) Security threats and its countermeasures, 4th International Conference on Applied and Theoretical Computing and Communication Technology (iCATecT – 2018) held on AIET, Mangalore, Karnataka, India, 6-8 September 2018.
2. Smart Healthcare Analysis and Therapy for Voice Disorder using Cloud and Edge Computing, 4th International Conference on Applied and Theoretical Computing and Communication Technology (iCATecT – 2018) held on AIET, Mangalore, Karnataka, India, 6-8 September 2018.
3. A Comparative Study of Medical Image Classification Using Machine Learning Methods, Research Advancements in Computational Informatics (RACI 2018) held on AGI, March 22-23 2018.
4. A Survey paper for Face Recognition System, Research Advancements in Computational Informatics (RACI 2018) held on AGI, March 22-23 2018.
5. A Survey on various IoT Attacks and its Countermeasures, Research Advancements in Computational Informatics (RACI 2018) held on AGI, March 22-23 2018.
6. Comparison of various face detection and face recognition algorithms, Research Advancements in Computational Informatics (RACI 2018) held on AGI, March 22-23 2018.
7. Facial Recognition Based on Straight Angle Fuzzy Texture Unit Matrix at the International Conference on Big Data Analytics and computational Intelligence (ICBDAC-2017) held in Chirala Engineering College, Chirala, India 23-25 March 2017.
8. Open Educational Resources for Content Management and Delivery at the International Conference on Transformations in Engineering Education (ICTIEE'17) held on Vardhaman College of Engineering, Hyderabad, India, 22 & 23 Jan 4-6 2017.
9. Privacy Preserving Public Auditing for Shared Data in Cloud in International Journal of Research (IJR) e-ISSN: 2348-6848, p-ISSN: 2348-795X Volume 2, Issue 10, October 2015
10. Classification of Child and Adulthood Using GLCM Based on Diagonal LBP presented at the International Conference on Applied and Theoretical Computing and Communication Technology (iCATecT – 2015) will be held in Bapuji Institute of Engineering & Technology (BIET), Davangere, Karnataka, India from 29 – 31 October 2015.
11. A Framework processing Images in Map Reduce Environment at the International Conference on International Conference on Recent Innovations in Engineering and Technology (ICRIEAT-2016) will be held in Karitya Hotel, Hyderabad, India, 22 & 23 December 2015.

## Journals

1. A. Mallikarjuna Reddy, V. Venkata Krishna, L. Sumalatha Face Recognition based on Cross Diagonal Complete Motif Matrix, IJ. Image, Graphics and Signal Processing, 2018, 3, 59-66.
2. A. Mallikarjuna Reddy, V. Venkata Krishna, L. Sumalatha. Face recognition based on stable uniform patterns International Journal of Engineering & Technology, 7 (2) (2018) 626-634.
3. A. Mallikarjuna Reddy, V. Venkata Krishna, L. Sumalatha. Efficient Face Recognition by Compact Symmetric Elliptical Texture Matrix (Csetm) Jour of Adv Research in Dynamical & Control Systems, Vol. 10, 4-Regular Issue, 2018.



  
PRINCIPAL  
Vignans Institute of Management & Technology For Women  
Kondapur(V), Ghatkesar(M), Medchal-Malkajgiri(Dt)-501301  
Telangana State



4. A. Mallikarjuna Reddy, G. RupaKinnera, T. Chandrasekhara Reddy, and G. Vishnu Murthy Generating Cancelable Fingerprint Template Using Triangular Structures Journal of Computational and Theoretical Nanoscience Vol. 16, 1951–1955, 2019.
5. A. Mallikarjuna Reddy, V. Venkata Krishna, L. Sumalatha. Age Classification using Motif and Statistical Features Derived on Gradient Facial Images Recent Patents on Computer Science vol.12 ,1-12,2019.
6. A.Mallikarjuna Reddy, B. KarunaSree Security towards Flooding Attacks in Inter Domain Routing Object using Ad hoc Network International Journal of Engineering and Advanced Technology (IJEAT) ISSN: 2249 – 8958, Volume-8 Issue-3, February 2019 .
7. M Purushotham Reddy, K Srinivasa Reddy, L Lakshmi, A. Mallikarjuna Reddy. Effective technique based on Intensity Huge Saturation and Standard Variation for Image Fusion of Satellite Images International Journal of Engineering and Advanced Technology (IJEAT) ISSN: 2249-8958, Volume-8 Issue-5, June 2019 .
8. B. Pruthvi Raj Goud, G. L. AnandBabu, G. Sekhar Reddy, A. Mallikarjuna Reddy. Multiple Object Detection interface using HSV,Hough and Haar – Classifier International Journal of Innovative Technology and Exploring Engineering (IJITEE) ISSN: 2278-3075, Volume-8 Issue-9, July 2019 .
9. P. Dayaker, P. Honey Diana, T. Chandrasekhara Reddy, A. Mallikarjuna Reddy Advancements of Security and Privacy of Sensitive Data Cloud Computing Jour of Adv Research in Dynamical & Control Systems, Vol. 10, 11-Special Issue, 2018.
10. A. Obulesh, P. Vamshi Krishna, A. Mallikarjuna Reddy. Classification of Lung Patterns based on Transition Neighborhood Pattern (TNP) Jour of Adv Research in Dynamical & Control Systems, Vol. 10, 15-Special Issue, 2018.
11. RavulaArun Kumar, A. Mallikarjuna Reddy, T. Chandrasekhar Reddy, M. Ravi Kishore A Study of Block Chain Technology and Cryptocurrency Jour of Adv Research in Dynamical & Control Systems, Vol. 10, 11-Special Issue, 2018.
12. T. Chandrasekhara Reddy, PinnapPranathi, A. Mallikarjun Reddy, G. Vishnu Murthy, and IlaiahKavati Biometric Template Security Using Convex Hulls Features Journal of Computational and Theoretical Nanoscience Vol. 16, 1947–1950, 201

  
PRINCIPAL

Vignans Institute of Management & Technology For Women  
Kondapur(V), Ghatkesar(M), Medchal-Malkajgiri(DT)-501301  
Telangana State





Date:22/10/22

### Workshop on Overview of NAAC Accreditation and Assessment Process

Workshop on NAAC was held on 22/10/22 in Seminar Hall of our Institution at 9:30 am. This Workshop on NAAC Accreditation and Assessment was organized by IQAC of our college with the aim of providing faculty members, with a comprehensive understanding of the NAAC accreditation process and guidelines.

**Speaker :** Dr.Mallikarjuna Reddy,Associate Professor,Anurag University.

Program was formally inaugurated by our beloved Principal Dr.Apparao Naidu and briefed about the importance of this Workshop.Later IQAC Co-ordinator welcomed the Speaker and handed over the Session.

Dr.Mallikarjuna Reddy,Associate Professor,Anurag University. Speaker of this programme commenced the session and Covered the following.

Overview of the NAAC accreditation process and its importance in quality assurance.

Benefits of accreditation for institutions, faculty, students, and othis stakeholders.

Detailed explanation of the NAAC criteria and the specific metrics used for assessment.

Guidelines for compiling a comprehensive SSR, including data collection, analysis, and documentation procedures.

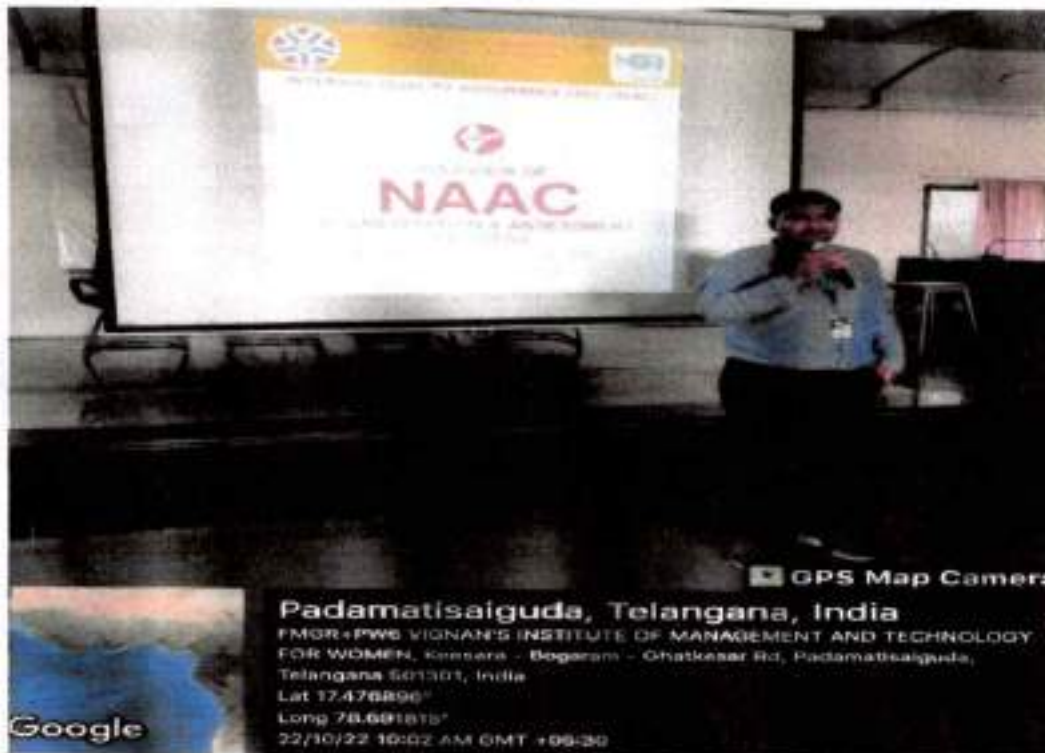

*ASh*  
PRINCIPAL

Vignans Institute of Management & Technology For Women  
Kondapur(V),Ghatkesar(M),Medchal-Malkajgiri(D)-501301  
Telangana State



Effective presentation techniques and strategies for organizing information in the SSR. Addressing the key aspects required by NAAC, such as curricular aspects, teaching-learning processes, student support systems, and governance.

Session ended with vote of thanks by IQAC Co-ordinator. He expressed his sincere appreciation to our keynote speaker for his thought-provoking presentations and for shedding light on the significance of NAAC accreditation in promoting quality assurance and continuous improvement in higher education institutions.

The Workshop on NAAC Accreditation and Assessment provided an excellent platform for participants to enhance their understanding of the accreditation process and acquire the necessary knowledge and skills to pursue accreditation successfully. The workshop enabled participants to familiarize themselves with the NAAC criteria, prepare a comprehensive SSR, and implement quality enhancement strategies in the institution.



*[Signature]*  
Program Co-ordinator  
**PRINCIPAL**  
Vignan's Institute of Management & Technology For Women  
Kondapur(V), Ghatkesar(M), Medchal-Malkajgiri(D)-501301  
Telangana State



# VIGNAN'S INSTITUTE OF MANAGEMENT AND TECHNOLOGY FOR WOMEN

Accredited By



CSE & ECE

(Sponsored by Lavu Educational Society)

Approved by AICTE, New Delhi & Affiliated to JNTUH, Hyderabad.

Kondapur (V), Ghatkesar (M), Medchal - Malkajgiri (D) - 501 301

## CERTIFICATE OF PARTICIPATION

This is to certify that Mr./Ms./Mrs. B. Phirlik  
of IT, Vignans Institute of management and Technology for women  
has participated in a WORKSHOP on "Overview of NAAC Accreditation and Assessment Process" held on 22<sup>nd</sup> October, 2022, Organized by IQAC, Vignans Institute of Management and Technology for Women.



  
Co-ordinator

Co-ordinator  
Quality Assurance Cell  
Vignans Institute of Management & Technology For Women  
(Kondapur (V), Ghatkesar (M), Malkajgiri (D) - 501301)

**Co-ordinator IQAC**  
Vignans Institute of Management & Technology For Women  
(Kondapur (V), Ghatkesar (M), Malkajgiri (D) - 501301)  
Telangana State



PRINCIPAL

Vignans Institute of Management & Technology For Women  
Kondapur (V), Ghatkesar (M), Medchal-Malkajgiri (D) - 501301  
Telangana State



Principal

Vignans Institute of Management & Technology For Women  
Kondapur (V), Ghatkesar (M), Medchal-Malkajgiri (D) - 501301  
Telangana State



# VIGNAN'S INSTITUTE OF MANAGEMENT AND TECHNOLOGY FOR WOMEN

(Sponsored by Lavu Educational Society)

Approved by AICTE, New Delhi & Affiliated to JNTUH, Hyderabad.

Kondapur (V), Ghatkesar (M), Medchal - Malkajgiri (D) - 501 301

Accredited By



## CERTIFICATE OF PARTICIPATION

This is to certify that Mr./Ms./Mrs. K. Bharath Reddy  
of IT, Vignans Institute of management and technology for women  
has participated in a WORKSHOP on "Overview of NAAC Accreditation and Assessment Process" held on 22<sup>nd</sup> October, 2022, Organized by IQAC, Vignans Institute of Management and Technology for Women.



  
Co-ordinator

Internal Quality Assurance Cell  
Coordinator, IQAC  
Vignans Institute of Management & Technology For Women  
Kondapur (V), Ghatkesar (M), Medchal - Malkajgiri (D) - 501301  
Telangana State



PRINCIPAL

Vignans Institute of Management & Technology For Women  
Kondapur (V), Ghatkesar (M), Medchal - Malkajgiri (D) - 501 301  
Telangana State

  
Principal

Vignans Institute of Management & Technology For Women  
Kondapur (V), Ghatkesar (M), Medchal - Malkajgiri (D) - 501 301  
Telangana State



# VIGNAN'S INSTITUTE OF MANAGEMENT AND TECHNOLOGY FOR WOMEN

(Sponsored by Lavu Educational Society)  
Approved by AICTE, New Delhi & Affiliated to JNTUH, Hyderabad.

Kondapur (V), Ghatkesar (M), Medchal - Malkajgiri (D) - 501 301

Accredited By



NATIONAL BOARD OF ACCREDITATION

CSE & ECE

## CERTIFICATE OF PARTICIPATION

This is to certify that Mr./Ms./Mrs. K. Helini

of II, Vignans Institute of management and Technology for women  
has participated in a WORKSHOP on "Overview of NAAC Accreditation and Assessment Process" held on 22<sup>nd</sup> October, 2022, Organized by IQAC, Vignans Institute of Management and Technology for Women.



PRINCIPAL

Vignans Institute of Management & Technology For Women  
Kondapur (V), Ghatkesar (M), Medchal-Malkajgiri (D) - 501301  
Telangana State

*[Signature]*

Co-ordinator, IQAC  
Vignans Institute of Management & Technology For Women  
Kondapur (V), Ghatkesar (M), Medchal-Malkajgiri (D) - 501301  
Telangana State

*[Signature]*

Principal  
Vignans Institute of Management & Technology For Women  
Kondapur (V), Ghatkesar (M), Medchal-Malkajgiri (D) - 501301  
Telangana State



# VIGNAN'S INSTITUTE OF MANAGEMENT AND TECHNOLOGY FOR WOMEN

(Sponsored by Lavu Educational Society)  
Approved by AICTE, New Delhi & Affiliated to JNTUH, Hyderabad.

Kondapur (V), Ghatkesar (M), Medchal - Malkajgiri (D) - 501 301



## CERTIFICATE OF PARTICIPATION

This is to certify that Mr./Ms./Mrs. V. Rupa

of IT, Vignans Institute of management and Technology for women  
has participated in a WORKSHOP on "Overview of NAAC Accreditation and Assessment Process" held on 22<sup>nd</sup> October, 2022, Organized by IQAC, Vignans Institute of Management and Technology for Women.



  
Co-ordinator  
Internal Quality Assurance Cell  
Vignans Institute of Management & Technology For Women  
Kondapur (V), Ghatkesar (M), Malkajgiri (D) - 501301  
Telangana State.



PRINCIPAL  
Vignans Institute of Management & Technology For Women  
Kondapur (V), Ghatkesar (M), Medchal-Malkajgiri (D) - 501301  
Telangana State.



Principal  
Vignans Institute of Management & Technology For Women  
Kondapur (V), Ghatkesar (M), Medchal-Malkajgiri (D) - 501301  
Telangana State.



# VIGNAN'S INSTITUTE OF MANAGEMENT AND TECHNOLOGY FOR WOMEN

(Sponsored by Lavu Educational Society)  
Approved by AICTE, New Delhi & Affiliated to JNTUH, Hyderabad.

Kondapur (V), Ghatkesar (M), Medchal - Malkajgiri (D) - 501 301

Accredited By



## CERTIFICATE OF PARTICIPATION

This is to certify that Mr./Ms./Mrs. Ch. Swapna

of IT, Vignan's Institute of management and Technology for women  
has participated in a WORKSHOP on "Overview of NAAC Accreditation and Assessment Process" held on 22<sup>nd</sup> October, 2022, Organized by IQAC, Vignan's Institute of Management and Technology for Women.



  
Co-ordinator  
Internal Quality Assurance Cell  
Vignan's Institute of Management & Technology For Women  
Medchal-Mahabubnagar (D)-501301  
Kondapur (V), Ghatkesar (M), Medchal-Mahabubnagar (D)-501301  
**Co-ordinator, IQAC**  
Telangana State



PRINCIPAL  
Vignan's Institute of Management & Technology For Women  
Medchal-Mahabubnagar (D)-501301  
Kondapur (V), Ghatkesar (M), Medchal-Mahabubnagar (D)-501301  
Telangana State



PRINCIPAL  
Vignan's Institute of Management & Technology For Women  
Medchal-Mahabubnagar (D)-501301  
Kondapur (V), Ghatkesar (M), Medchal-Mahabubnagar (D)-501301  
Telangana State





# VIGNAN'S INSTITUTE OF MANAGEMENT AND TECHNOLOGY FOR WOMEN

(Sponsored by Lawu Educational Society)  
Approved by AICTE, New Delhi & Affiliated to JNTUH, Hyderabad.

Kondapur (V), Ghatkesar (M), Medchal - Malkajgiri (D) - 501 301

Accredited By



## CERTIFICATE OF PARTICIPATION

This is to certify that Mr./Ms./Mrs.     G. Ramya    

of IT, Vignans Institute of management and Technology for women  
has participated in a WORKSHOP on "Overview of NAAC Accreditation and Assessment Process" held on 22<sup>nd</sup> October, 2022, Organized by IQAC, Vignans Institute of Management and Technology for Women.



*[Signature]*  
Co-ordinator  
Internal Quality Assurance Cell  
Management & Technology For Women  
Vignans Institute of Management & Technology for Women  
Kondapur (V), Ghatkesar (M), Medchal - Malkajgiri (D) - 501 301  
Telangana State

PRINCIPAL

*[Signature]*  
Vignans Institute of Management & Technology For Women  
Kondapur (V), Ghatkesar (M), Medchal - Malkajgiri (D) - 501 301  
Telangana State

PRINCIPAL

*[Signature]*  
Vignans Institute of Management & Technology For Women  
Kondapur (V), Ghatkesar (M), Medchal - Malkajgiri (D) - 501 301  
Telangana State



# VIGNAN'S INSTITUTE OF MANAGEMENT AND TECHNOLOGY FOR WOMEN

(Sponsored by Lavu Educational Society)

Approved by AICTE, New Delhi & Affiliated to JNTUH, Hyderabad.

Kondapur (V), Ghatkesar (M), Medchal - Malkajgiri (D) - 501 301

Accredited By



NATIONAL BOARD OF ACCREDITATION

CSE & ECE

## CERTIFICATE OF PARTICIPATION

This is to certify that Mr./Ms./Mrs. Dr. S. Ranga Swamy of AIML, Vignan's Institute of management and Technology for women. has participated in a WORKSHOP on "Overview of NAAC Accreditation and Assessment Process" held on 22<sup>nd</sup> October, 2022, Organized by IQAC, Vignan's Institute of Management and Technology for Women.

*naac*



*[Signature]*  
Co-ordinator  
Internal Quality Assurance Cell  
Vignan's Institute of Management & Technology For Women  
Kondapur (V), Ghatkesar (M), Medchal-Malkajgiri (D)-501301  
Telangana State

*[Signature]*  
PRINCIPAL  
Vignan's Institute of Management & Technology For Women  
Kondapur (V), Ghatkesar (M), Medchal-Malkajgiri (D)-501301  
Telangana State

PRINCIPAL & Principal  
Vignan's Institute of Management & Technology For Women  
Kondapur (V), Ghatkesar (M), Medchal-Malkajgiri (D)-501301  
Telangana State



# VIGNAN'S INSTITUTE OF MANAGEMENT AND TECHNOLOGY FOR WOMEN

(Sponsored by Lavu Educational Society)

Approved by AICTE, New Delhi & Affiliated to JNTUH, Hyderabad.

Kondapur (V), Ghatkesar (M), Medchal - Malkajgiri (D) - 501 301

Accredited By



## CERTIFICATE OF PARTICIPATION

This is to certify that Mr./Ms./Mrs. P. Shilpa Sri of AIML, Vignan's Institute of Management and Technology for women has participated in a WORKSHOP on "Overview of NAAC Accreditation and Assessment Process" held on 22<sup>nd</sup> October, 2022, Organized by IQAC, Vignan's Institute of Management and Technology for Women.



*[Signature]*  
Co-ordinator

Co-ordinator  
Normal Quality Assurance Cell  
Vignan's Institute of Management & Technology For Women  
Kondapur (V), Ghatkesar (M), Medchal-Malkajgiri (D)-501301  
T.S.

**Co-ordinator, IQAC**  
Vignan's Institute of Management & Technology For Women  
Kondapur (V), Ghatkesar (M), Medchal-Malkajgiri (D)-501301  
T.S.

*[Signature]*  
PRINCIPAL

Principal  
Vignan's Institute of Management & Technology For Women  
Kondapur (V), Ghatkesar (M), Medchal-Malkajgiri (D)-501301  
T.S.

*[Signature]*

Principal

Vignan's Institute of Management & Technology For Women  
Kondapur (V), Ghatkesar (M), Medchal-Malkajgiri (D)-501301  
T.S.



# VIGNAN'S INSTITUTE OF MANAGEMENT AND TECHNOLOGY FOR WOMEN

(Sponsored by Lawu Educational Society)  
Approved by AICTE, New Delhi & Affiliated to JNTUH, Hyderabad.

Kondapur (V), Ghatkesar (M), Medchal - Malkajgiri (D) - 501 301



## CERTIFICATE OF PARTICIPATION

This is to certify that Mr./Ms./Mrs. A. Srilatha  
of AIML, Vignan's Institute of management & Technology for women  
has participated in a WORKSHOP on "Overview of NAAC Accreditation and Assessment  
Process" held on 22<sup>nd</sup> October, 2022, Organized by IQAC, Vignan's Institute of  
Management and Technology for Women.



  
Coordinator  
Internal Quality Assurance Cell  
**Coordinator, IQAC**  
Vignan's Institute of Management & Technology For Women  
Kondapur (V), Ghatkesar (M), Medchal - Malkajgiri (D)  
Telangana State

  
PRINCIPAL  
Vignan's Institute of Management & Technology For Women  
Kondapur(V), Ghatkesar(M), Medchal-Malkajgiri(D)-501301  
Telangana State

  
Principal  
Vignan's Institute of Management & Technology For Women



# VIGNAN'S INSTITUTE OF MANAGEMENT AND TECHNOLOGY FOR WOMEN

(Sponsored by Lavu Educational Society)

Approved by AICTE, New Delhi & Affiliated to JNTUH, Hyderabad.

Kondapur (V), Ghatkesar (M), Medchal - Malkajgiri (D) - 501 301



## CERTIFICATE OF PARTICIPATION

This is to certify that Mr./Mrs. Dr. Srinivasulu Thonukunuri of BSTH, Vignan's Institute of management and Technology for women has participated in a WORKSHOP on "Overview of NAAC Accreditation and Assessment Process" held on 22<sup>nd</sup> October, 2022, Organized by IQAC, Vignan's Institute of Management and Technology for Women.

*[Signature]*  
PRINCIPAL

Vignan's Institute of Management & Technology For Women  
Kondapur (V), Ghatkesar (M), Medchal-Malkajgiri (D)-501301  
Telangana State

*[Signature]*  
Co-ordinator  
Vignan's Institute of Management & Technology For Women  
Kondapur (V), Ghatkesar (M), Medchal-Malkajgiri (D)-501301  
Telangana State



*[Signature]*  
PRINCIPAL  
Vignan's Institute of Management & Technology For Women  
Kondapur (V), Ghatkesar (M), Medchal-Malkajgiri (D)-501301  
Telangana State



# VIGNAN'S INSTITUTE OF MANAGEMENT AND TECHNOLOGY FOR WOMEN

(Sponsored by Law Education Society)  
Approved by AICTE, New Delhi & Affiliated to JNTUH, Hyderabad.

Kondapur (V), Ghatkesar (M), Medchal - Malkajgiri (D) - 501 301



## CERTIFICATE OF PARTICIPATION

This is to certify that Mr./Ms./Mrs. Dr. Y. Sathish  
of BSH, Vignans Institute of management and Technology for women  
has participated in a WORKSHOP on "Overview of NAAC Accreditation and Assessment Process" held on 22<sup>nd</sup> October, 2022. Organized by IQAC, Vignans Institute of Management and Technology for Women.



*[Signature]*  
Co-ordinator  
Internal Quality Assurance Cell  
Management & Technology For Women  
Vignans Institute of Management & Technology For Women  
Kondapur (V), Ghatkesar (M), Medchal - Malkajgiri (D) - 501301  
Telangana State

*[Signature]*  
PRINCIPAL  
Vignans Institute of Management & Technology For Women  
Kondapur (V), Ghatkesar (M), Medchal - Malkajgiri (D) - 501301  
Telangana State

*[Signature]*  
PRINCIPAL  
Vignans Institute of Management & Technology For Women  
Kondapur (V), Ghatkesar (M), Medchal - Malkajgiri (D) - 501301  
Telangana State



# VIGNAN'S INSTITUTE OF MANAGEMENT AND TECHNOLOGY FOR WOMEN

(Sponsored by Law Education Society)  
Approved by AICTE, New Delhi & Affiliated to JNTUH, Hyderabad.

Kondapur (V), Ghatkesar (M), Medchal - Malkajgiri (D) - 501 301



## CERTIFICATE OF PARTICIPATION

This is to certify that Mr./Ms./Mrs. Dr. K. Manjula  
of BST, Vignan's Institute of management and Technology for women  
has participated in a WORKSHOP on "Overview of NAAC Accreditation and Assessment  
Process" held on 22<sup>nd</sup> October, 2022, Organized by IQAC, Vignan's Institute of  
Management and Technology for Women.

  
PRINCIPAL  
Vignan's Institute of Management & Technology For Women  
Kondapur(V), Ghatkesar(M), Medchal-Malkajgiri(D)-501301  
Telangana State

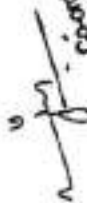
  
Co-ordinator  
Vignan's Institute of Management & Technology For Women  
Kondapur(V), Ghatkesar(M), Medchal-Malkajgiri(D)-501301  
Telangana State



  
PRINCIPAL  
Vignan's Institute of Management & Technology For Women  
Kondapur(V), Ghatkesar(M), Medchal-Malkajgiri(D)-501301  
Telangana State



# VIGNAN'S INSTITUTE OF MANAGEMENT AND TECHNOLOGY FOR WOMEN

(Sponsored by Lavu Educational Society)  
Approved by AICTE, New Delhi & Affiliated to JNTUH, Hyderabad.  
Kondapur (V), Ghatkesar (M), Medchal - Malkajgiri (D) - 501 301



## CERTIFICATE OF PARTICIPATION

This is to certify that Mr./Ms./Mrs. Dr. Kandimalla Srija  
of BSH, Vignans Institute of management and Technology for women  
has participated in a WORKSHOP on "Overview of NAAC Accreditation and Assessment  
Process" held on 22<sup>nd</sup> October, 2022, Organized by IQAC, Vignans Institute of  
Management and Technology for Women.

*[Signature]*  
PRINCIPAL  
Vignans Institute of Management & Technology For Women  
Kondapur(V), Ghatkesar(M), Medchal-Malkajgiri(D)-501301  
Telangana State

*[Signature]*  
Co-ordinator  
Internal Quality Assurance Cell  
(Management & Technology) For Women  
Vignans Institute of Management & Technology  
Kondapur (V), Ghatkesar (M), Malkajgiri (D)  
Telangana State



*[Signature]*  
Principal  
Vignans Institute of Management & Technology For Women





# VIGNAN'S INSTITUTE OF MANAGEMENT AND TECHNOLOGY FOR WOMEN

(Sponsored by Lavu Educational Society)

Approved by AICTE, New Delhi & Affiliated to JNTUH, Hyderabad.

Kondapur (V), Ghatkesar (M), Medchal - Malkajgiri (D) - 501 301



## CERTIFICATE OF PARTICIPATION

This is to certify that Mr./Ms./Mrs. Dileep Thotakurri  
of BSh, Vignans Institute of management and Technology for women  
has participated in a WORKSHOP on "Overview of NAAC Accreditation and Assessment Process" held on 22<sup>nd</sup> October, 2022, Organized by IQAC, Vignans Institute of Management and Technology for Women.



*[Signature]*  
Co-ordinator  
Vignans Institute of Management & Technology for Women  
Kondapur(V), Ghatkesar(M), Medchal-Malkajgiri(D)-501301  
Telangana State

PRINCIPAL

*[Signature]*  
Principal  
Vignans Institute of Management & Technology for Women  
Kondapur(V), Ghatkesar(M), Medchal-Malkajgiri(D)-501301  
Telangana State



# VIGNAN'S INSTITUTE OF MANAGEMENT AND TECHNOLOGY FOR WOMEN

(Sponsored by Lavu Educational Society)

Approved by AICTE, New Delhi & Affiliated to JNTUH, Hyderabad.

Kondapur (V), Ghatkesar (M), Medchal - Malkajgiri (D) - 501 301



## CERTIFICATE OF PARTICIPATION

This is to certify that Mr./Ms./Mrs. Kavitha Danti  
of BSH, Vignan's Institute of management and Technology for women  
has participated in a WORKSHOP on "Overview of NAAC Accreditation and Assessment Process" held on 22<sup>nd</sup> October, 2022, Organized by IQAC, Vignan's Institute of Management and Technology for Women.



  
Coordinator  
Internal Quality Assurance Cell  
**Coordinator IQAC**  
Vignan's Institute of Management & Technology For Women  
Kondapur (V), Ghatkesar (M), Medchal-Malkajgiri (D) - 501301  
Telangana State

  
PRINCIPAL  
Vignan's Institute of Management & Technology for Women  
Kondapur (V), Ghatkesar (M), Medchal-Malkajgiri (D) - 501301  
Telangana State

  
**Principal**  
Vignan's Institute of Management & Technology For Women



# VIGNAN'S INSTITUTE OF MANAGEMENT AND TECHNOLOGY FOR WOMEN

(Sponsored by Lavu Educational Society)

Approved by AICTE, New Delhi & Affiliated to JNTUJH, Hyderabad.

Kondapur (V), Ghatkesar (M), Medchal - Malkajgiri (D) - 501 301



## CERTIFICATE OF PARTICIPATION

This is to certify that Mr./Mrs. Santhosh Kumar Kodam  
of BSH, Vignan's Institute of management and Technology for women  
has participated in a WORKSHOP on "Overview of NAAC Accreditation and Assessment  
Process" held on 22<sup>nd</sup> October, 2022. Organized by IQAC, Vignan's Institute of  
Management and Technology for Women.

*Santhosh*  
PRINCIPAL

Vignan's Institute of Management & Technology for Women  
Kondapur(V), Ghatkesar(M), Medchal-Malkajgiri(D)-501301  
Telangana State

*[Signature]*  
Coordinator  
Internal Quality Assurance Cell  
Vignan's Institute of Management & Technology for Women  
Kondapur (V), Medchal-Malkajgiri (D)-501301  
Co-ordinator IQAC



*[Signature]*

Principa PRINCIPAL  
Vignan's Institute of Management & Technology for Women  
Kondapur (V), Medchal-Malkajgiri (D)-501301  
Telangana State



# VIGNAN'S INSTITUTE OF MANAGEMENT AND TECHNOLOGY FOR WOMEN

(Sponsored by Lawu Educational Society)  
Approved by AICTE, New Delhi & Affiliated to JNTUJH, Hyderabad.  
Kondapur (V), Ghatkesar (M), Medchal - Malkajgiri (D) - 501 301



## CERTIFICATE OF PARTICIPATION

This is to certify that Mr./Mrs. Komarelli Bal Reddy  
of BSH, Vignan's Institute of management and Technology for women  
has participated in a WORKSHOP on "Overview of NAAC Accreditation and Assessment Process" held on 22<sup>nd</sup> October, 2022, Organized by IQAC, Vignan's Institute of Management and Technology for Women.

*NAAC*  
PRINCIPAL  
Vignan's Institute of Management & Technology for Women  
Kondapur (V), Ghatkesar (M), Medchal-Malkajgiri (D)-501301  
Telangana State



*[Signature]*  
Co-ordinator  
Internal Quality Assurance Cell  
Vignan's Institute of Management & Technology for Women  
Kondapur (V), Ghatkesar (M), Medchal-Malkajgiri (D)-501301  
Telangana State

*NAAC*  
PRINCIPAL  
Vignan's Institute of Management & Technology for Women  
Kondapur (V), Ghatkesar (M), Medchal-Malkajgiri (D)-501301  
Telangana State



# VIGNAN'S INSTITUTE OF MANAGEMENT AND TECHNOLOGY FOR WOMEN

(Sponsored by Law Educational Society)  
Approved by AICTE, New Delhi & Affiliated to JNTUH, Hyderabad.

Kondapur (V), Ghatkesar (M), Medchal - Malkajgiri (D) - 501 301



## CERTIFICATE OF PARTICIPATION

This is to certify that Mr./Ms./Mrs. Maddi Swamy  
of BSH, Vignans Institute of management and Technology for women  
has participated in a WORKSHOP on "Overview of NAAC Accreditation and Assessment  
Process" held on 22<sup>nd</sup> October, 2022. Organized by IQAC, Vignans Institute of  
Management and Technology for Women.



Internal Quality Assurance Cell  
Vignans Institute of Management & Technology for Women  
Kondapur (V), Ghatkesar (M), Medchal - Malkajgiri (D) - 501301  
Telangana State

*NAAC*  
PRINCIPAL

Vignans Institute of Management & Technology for Women  
Kondapur(V), Ghatkesar(M), Medchal-Malkajgiri(D)-501301  
Telangana State

PRINCIPAL  
Vignans Institute of Management & Technology for Women



# VIGNAN'S INSTITUTE OF MANAGEMENT AND TECHNOLOGY FOR WOMEN

(Sponsored by Lavu Educational Society)

Approved by AICTE, New Delhi & Affiliated to JNTUH, Hyderabad.

Kondapur (V), Ghatkesar (M), Medchal - Malkajgiri (D) - 501 301



## CERTIFICATE OF PARTICIPATION

This is to certify that Mr./Mrs./Ms. A. Mallikarjuna  
of BSh, Vignan's Institute of management and Technology for women  
has participated in a WORKSHOP on "Overview of NAAC Accreditation and Assessment  
Process" held on 22<sup>nd</sup> October, 2022, Organized by IQAC, Vignan's Institute of  
Management and Technology for Women.

*Principal*  
PRINCIPAL  
Vignan's Institute of Management & Technology for Women  
Kondapur (V), Ghatkesar (M), Medchal - Malkajgiri (D) - 501301  
Telangana State

*Co-ordinator*  
Co-ordinator  
National Quality Assurance  
Institute of Management & Technology for Women  
Kondapur (V), Ghatkesar (M), Medchal - Malkajgiri (D) - 501301  
Telangana State



*Principal*  
PRINCIPAL  
Vignan's Institute of Management & Technology for Women  
Kondapur (V), Ghatkesar (M), Medchal - Malkajgiri (D) - 501301  
Telangana State



# VIGNAN'S INSTITUTE OF MANAGEMENT AND TECHNOLOGY FOR WOMEN

(Sponsored by Lawu Educational Society)  
Approved by AICTE, New Delhi & Affiliated to JNTUH, Hyderabad.

Kondapur (V), Ghatkesar (M), Medchal - Malkajgiri (D) - 501 301



## CERTIFICATE OF PARTICIPATION

This is to certify that Mr./Ms./Mrs. R. Manjula  
of BSH, Vignan's Institute of management and Technology for women  
has participated in a WORKSHOP on "Overview of NAAC Accreditation and Assessment Process" held on 22<sup>nd</sup> October, 2022, Organized by IQAC, Vignan's Institute of Management and Technology for Women.

  
Co-ordinator  
Internal Quality Assurance  
(Management & Technology) For Women  
Vignan's Institute of Management & Technology (IQAC)  
Kondapur (V), Ghatkesar (M), Medchal - Malkajgiri (D) - 501301  
Telangana State

  
Principal  
Vignan's Institute of Management & Technology For Women  
Kondapur (V), Ghatkesar (M), Medchal - Malkajgiri (D) - 501301  
Telangana State





# VIGNAN'S INSTITUTE OF MANAGEMENT AND TECHNOLOGY FOR WOMEN

(Sponsored by Lavu Educational Society)

Approved by AICTE, New Delhi & Affiliated to JNTUH, Hyderabad.

Kondapur (V), Ghatkesar (M), Medchal - Malkajgiri (D) - 501 301



## CERTIFICATE OF PARTICIPATION

This is to certify that Mr./Ms./Mrs. Md Khaleel Akhtar  
of BSH, Vignans Institute of management and Technology for women  
has participated in a WORKSHOP on "Overview of NAAC Accreditation and Assessment Process" held on 22<sup>nd</sup> October, 2022, Organized by IQAC, Vignans Institute of Management and Technology for Women.

PRINCIPAL

Vignans Institute of Management & Technology for Women  
Kondapur (V), Ghatkesar (M), Medchal-malkajgiri (D) - 501301  
Telangana State

Co-ordinator

Co-ordinator  
Vignans Institute of Management & Technology for Women  
Kondapur (V), Ghatkesar (M), Medchal-malkajgiri (D) - 501301  
Telangana State



Principal  
Vignans Institute of Management & Technology for Women  
Kondapur (V), Ghatkesar (M), Medchal-malkajgiri (D) - 501301





# VIGNAN'S INSTITUTE OF MANAGEMENT AND TECHNOLOGY FOR WOMEN

(Sponsored by Lavu Educational Society)  
Approved by AICTE, New Delhi & Affiliated to JNTUH, Hyderabad  
Kondapur (V), Ghatkesar (M), Medchal - Malkajgiri (D) - 501 301



## CERTIFICATE OF PARTICIPATION

This is to certify that Mr./Ms./Mrs. Suzanshalini Yurum  
of BSH, Vignans Institute of management and Technology for women  
has participated in a WORKSHOP on "Overview of NAAC Accreditation and Assessment  
Process" held on 22<sup>nd</sup> October, 2022, Organized by IQAC, Vignans Institute of  
Management and Technology for Women.



Coordinator  
Internal Quality Assurance Cell  
Vignans Institute of Management & Technology for Women  
Kondapur (V), Ghatkesar (M), Medchal - Malkajgiri (D) - 501 301  
Telangana State

Principal  
Vignans Institute of Management & Technology for Women  
Kondapur (V), Ghatkesar (M), Medchal - Malkajgiri (D) - 501 301  
Telangana State

*[Signature]*  
Principal



# TECHNOLOGY FOR WOMEN

(Sponsored by Lavu Educational Society)

Approved by AICTE, New Delhi & Affiliated to JNTUH, Hyderabad.

Kondapur (V), Ghatkesar (M), Medchal - Malkajgiri (D) - 501 301



## CERTIFICATE OF PARTICIPATION

This is to certify that Mr./Ms./Mrs. Venkatesham Boorna  
of BSH, Vignan's Institute of management and Technology for women  
has participated in a WORKSHOP on "Overview of NAAC Accreditation and Assessment  
Process" held on 22<sup>nd</sup> October, 2022, Organized by IQAC, Vignan's Institute of  
Management and Technology for Women.

*[Signature]*  
PRINCIPAL

Vignan's Institute of Management & Technology for Women  
Kondapur (V), Ghatkesar (M), Medchal - Malkajgiri (D) - 501 301  
Telangana State

*[Signature]*  
Co-ordinator  
Vignan's Institute of Management & Technology for Women  
Kondapur (V), Ghatkesar (M), Medchal - Malkajgiri (D) - 501 301  
Telangana State



*[Signature]*  
Principal  
Vignan's Institute of Management & Technology for Women  
Kondapur (V), Ghatkesar (M), Medchal - Malkajgiri (D) - 501 301  
Telangana State



# VIGNAN'S INSTITUTE OF MANAGEMENT AND TECHNOLOGY FOR WOMEN

(Sponsored by Lavu Educational Society)  
Approved by AICTE, New Delhi & Affiliated to JNTUH, Hyderabad.  
Kondapur (V), Ghatkesar (M), Medchal - Malkajgiri (D) - 501 301



## CERTIFICATE OF PARTICIPATION

This is to certify that Mr./Mrs. ✓ S. Ramadevi  
of B.S.H, Vignan's Institute of management and Technology for women  
has participated in a WORKSHOP on "Overview of NAAC Accreditation and Assessment Process" held on 22<sup>nd</sup> October, 2022, Organized by IQAC, Vignan's Institute of Management and Technology for Women.

*ADN*  
Principal  
Vignan's Institute of Management & Technology for Women  
Kondapur (V), Ghatkesar (M), Medchal - Malkajgiri (D) - 501 301  
Telangana - 501301

*[Signature]*  
Coordinator  
Internal Quality Assurance Cell  
Vignan's Institute of Management & Technology for Women  
Kondapur (V), Ghatkesar (M), Medchal - Malkajgiri (D) - 501 301



*[Signature]*  
Principal  
Vignan's Institute of Management & Technology for Women  
Kondapur (V), Ghatkesar (M), Medchal - Malkajgiri (D) - 501 301  
Telangana - 501301



# VIGNAN'S INSTITUTE OF MANAGEMENT AND TECHNOLOGY FOR WOMEN

(Sponsored by Lavu Educational Society)

Approved by AICTE, New Delhi & Affiliated to JNTUH, Hyderabad.

Kondapur (V), Ghatkesar (M), Medchal - Malkajgiri (D) - 501 301



## CERTIFICATE OF PARTICIPATION

This is to certify that Mr./Mrs. Prasad Gattu of BSH, Vignan's Institute of management and Technology for women has participated in a WORKSHOP on "Overview of NAAC Accreditation and Assessment Process" held on 22<sup>nd</sup> October, 2022, Organized by IQAC, Vignan's Institute of Management and Technology for Women.

PRINCIPAL

Vignan's Institute of Management & Technology For Women  
Kondapur (V), Ghatkesar (M), Medchal-Malkajgiri (D)-501301  
Telangana State

Co-ordinator  
Internal Quality Assurance Cell  
Vignan's Institute of Management & Technology For Women  
Kondapur (V), Ghatkesar (M), Medchal-Malkajgiri (D)-501301

Co-ordinator IQAC  
Vignan's Institute of Management & Technology For Women  
Kondapur (V), Ghatkesar (M), Medchal-Malkajgiri (D)-501301



Principal  
Vignan's Institute of Management & Technology For Women  
Kondapur (V), Ghatkesar (M), Medchal-Malkajgiri (D)-501301  
Telangana State



# VIGNAN'S INSTITUTE OF MANAGEMENT AND TECHNOLOGY FOR WOMEN

(Sponsored by Lawu Educational Society)  
Approved by AICTE, New Delhi & Affiliated to JNTUH, Hyderabad.  
Kondapur (V), Ghatkesar (M), Medchal - Malkajgiri (D) - 501 301



## CERTIFICATE OF PARTICIPATION

This is to certify that Mr./Mrs. Raja Babu Kammakuri  
of BST, Vignans Institute of management and Technology for women  
has participated in a WORKSHOP on "Overview of NAAC Accreditation and Assessment  
Process" held on 22<sup>nd</sup> October, 2022. Organized by IQAC, Vignans Institute of  
Management and Technology for Women.

*[Signature]*  
Co-ordinator  
Internal Quality Assurance Cell  
Vignans Institute of Management & Technology For Women  
Kondapur (V), Ghatkesar (M), Medchal - Malkajgiri (D) - 501 301  
Telangana State

*[Signature]*  
PRINCIPAL  
Vignans Institute of Management & Technology For Women  
Kondapur (V), Ghatkesar (M), Medchal - Malkajgiri (D) - 501 301  
Telangana State



*[Signature]*  
PRINCIPAL  
Vignans Institute of Management & Technology For Women  
Kondapur (V), Ghatkesar (M), Medchal - Malkajgiri (D) - 501 301  
Telangana State



# VIGNAN'S INSTITUTE OF MANAGEMENT AND TECHNOLOGY FOR WOMEN

(Sponsored by Lavu Educational Society)

Approved by AICTE, New Delhi & Affiliated to JNTUH, Hyderabad.

Kondapur (V), Ghatkesar (M), Medchal - Malkajgiri (D) - 501 301



## CERTIFICATE OF PARTICIPATION

This is to certify that Mr./Ms./Mrs. M. Ravindranath  
of BSTH, Vignan's Institute of management and Technology for women  
has participated in a WORKSHOP on "Overview of NAAC Accreditation and Assessment  
Process" held on 22<sup>nd</sup> October, 2022, Organized by IQAC, Vignan's Institute of  
Management and Technology for Women.

*Handwritten signature*  
PRINCIPAL

*Handwritten signature*  
Co-ordinating Officer IQAC  
Vignan's Institute of Management & Technology for Women  
Kondapur (V), Ghatkesar (M), Medchal-Malkajgiri (D) - 501301  
Telangana State



*Handwritten signature*  
PRINCIPAL  
Vignan's Institute of Management & Technology for Women  
Kondapur (V), Ghatkesar (M), Medchal-Malkajgiri (D) - 501301  
Telangana State



# VIGNAN'S INSTITUTE OF MANAGEMENT AND TECHNOLOGY FOR WOMEN

(Sponsored by Lawu Educational Society)

Approved by AICTE, New Delhi & Affiliated to JNTUH, Hyderabad.

Kondapur (V), Ghatkesar (M), Medchal - Malkajgiri (D) - 501 301



## CERTIFICATE OF PARTICIPATION

This is to certify that Mr./Ms./Mrs. B. Bhavani of BSH, Vignans Institute of management and Technology for women has participated in a WORKSHOP on "Overview of NAAC Accreditation and Assessment Process" held on 22<sup>nd</sup> October, 2022, Organized by IQAC, Vignans Institute of Management and Technology for Women.

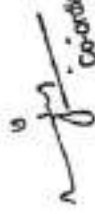

  
Co-ordinator  
Internal Quality Assurance Cell  
Management & Technology For Women  
Vignans Institute of Management & Technology (D)-501301  
Kondapur (V), Ghatkesar (M), Medchal (D), Malkajgiri (D) - 501301  
Telangana State  
**Co-ordinator IQAC**

  
PRINCIPAL  
Vignans Institute of Management & Technology For Women  
Management & Technology (D)-501301  
Kondapur (V), Ghatkesar (M), Medchal (D), Malkajgiri (D) - 501301  
Telangana State  
**Principal**  
Vignans Institute of Management & Technology For Women







# VIGNANA'S INSTITUTE OF MANAGEMENT AND TECHNOLOGY FOR WOMEN

(Sponsored by Lawu Educational Society)  
Approved by AICTE, New Delhi & Affiliated to JNTUH, Hyderabad.

Kondapur (V), Ghatkesar (M), Medchal - Malkajgiri (D) - 501 301



## CERTIFICATE OF PARTICIPATION

This is to certify that Mr./Ms./Mrs. Venkat Rao Ubbala  
of CSE, Vignana's Institute of management and Technology for women  
has participated in a WORKSHOP on "Overview of NAAC Accreditation and Assessment  
Process" held on 22<sup>nd</sup> October, 2022, Organized by IQAC, Vignana's Institute of  
Management and Technology for Women.

*AA*  
**PRINCIPAL**  
Vignana's Institute of Management & Technology for Women  
Kondapur(V), Ghatkesar(M), Medchal-Malkajgiri(D)-501301  
Telangana State

*AA*  
Co-ordinator  
Internal Quality Assurance Cell  
**CAORDINATOR**  
Vignana's Institute of Management & Technology for Women  
Kondapur (V), Ghatkesar (M), Medchal-Malkajgiri (D)-501301  
Telangana State



Vignana's Institute of Management & Technology for Women



# TECHNOLOGY FOR WOMEN

(Sponsored by Lavu Educational Society)

Approved by AICTE, New Delhi & Affiliated to JNTUH, Hyderabad.

Kondapur (V), Ghatkesar (M), Medchal - Malkajgiri (D) - 501 301

ACCREDITED AND

Approved by



NATIONAL BOARD OF ACCREDITATION

CSE & ECE

## CERTIFICATE OF PARTICIPATION

This is to certify that Mr./Ms./Mrs. M. Uday Kumar of CSE, Vignan's Institute of management and Technology for women has participated in a WORKSHOP on "Overview of NAAC Accreditation and Assessment Process" held on 22<sup>nd</sup> October, 2022, Organized by IQAC, Vignan's Institute of Management and Technology for Women.

*Principal*  
Principal  
Vignan's Institute of Management & Technology For Women  
Ghatkesar (M), Medchal-Malkajgiri (D) - 501 301  
Telangana State

*Co-ordinator*  
Co-ordinator  
Vignan's Institute of Management & Technology For Women  
Ghatkesar (M), Medchal-Malkajgiri (D) - 501 301  
Telangana State



*Principal*  
Principal  
Vignan's Institute of Management & Technology For Women  
Ghatkesar (M), Medchal-Malkajgiri (D) - 501 301  
Telangana State



# VIGNAN'S INSTITUTE OF MANAGEMENT AND TECHNOLOGY FOR WOMEN

(Sponsored by Law Educational Society)

Approved by AICTE, New Delhi & Affiliated to JNTUH, Hyderabad.

Kondapur (V), Ghatkesar (M), Medchal - Malkajgiri (D) - 501 301



## CERTIFICATE OF PARTICIPATION

This is to certify that Mr./Mrs. Sathini Santhosh Kumar of CSE, Vignans Institute of Management and Technology for women has participated in a WORKSHOP on "Overview of NAAC Accreditation and Assessment Process" held on 22<sup>nd</sup> October, 2022, Organized by IQAC, Vignans Institute of Management and Technology for Women.

  
PRINCIPAL  
Vignans Institute of Management & Technology For Women  
Kondapur(V), Ghatkesar(M), Medchal-Malkajgiri(DI)-501301  
Telangana State

  
Coordinator  
Internal Quality Assurance Cell  
Vignans Institute of Management & Technology For Women  
Kondapur(V), Ghatkesar(M), Medchal-Malkajgiri(DI)-501301  
Telangana State



  
Principal  
Vignans Institute of Management & Technology For Women  
Kondapur(V), Ghatkesar(M), Medchal-Malkajgiri(DI)-501301  
Telangana State



# VIGNAN'S INSTITUTE OF MANAGEMENT AND TECHNOLOGY FOR WOMEN

(Sponsored by Lavu Educational Society)  
Approved by AICTE, New Delhi & Affiliated to JNTUH, Hyderabad.

Kondapur (V), Ghatkesar (M), Medchal - Malkajgiri (D) - 501 301



## CERTIFICATE OF PARTICIPATION

This is to certify that Mr./Mrs. R. Krishna Naik  
of CSE, Vignans Institute of management and Technology for women  
has participated in a WORKSHOP on "Overview of NAAC Accreditation and Assessment Process" held on 22<sup>nd</sup> October, 2022, Organized by IQAC, Vignans Institute of Management and Technology for Women.

*Handwritten signature*  
PRINCIPAL

Vignans Institute of Management & Technology for Women  
Kondapur(V), Ghatkesar(M), Medchal-Malkajgiri(D)-501301  
Telangana State

*Handwritten signature*  
Co-ordinator  
Internal Quality Assurance Cell  
Vignans Institute of Management & Technology for Women  
Kondapur(V), Ghatkesar(M), Malkajgiri(D)-501301  
Telangana State



*Handwritten signature*  
Principal  
Vignans Institute of Management & Technology for Women  
Kondapur(V), Ghatkesar(M), Malkajgiri(D)-501301  
Telangana State



# VIGNAN'S INSTITUTE OF MANAGEMENT AND TECHNOLOGY FOR WOMEN

(Sponsored by Lawu Educational Society)  
Approved by AICTE, New Delhi & Affiliated to JNTUH, Hyderabad.

Kondapur (V), Ghatkesar (M), Medchal - Malkajgiri (D) - 501 301



## CERTIFICATE OF PARTICIPATION

This is to certify that Mr./Mrs. S. Sandeep Babu  
of CSE, Vignan's Institute of management and Technology for women  
has participated in a WORKSHOP on "Overview of NAAC Accreditation and Assessment Process" held on 22<sup>nd</sup> October, 2022, Organized by IQAC, Vignan's Institute of Management and Technology for Women.



  
Co-ordinator  
Internal Quality Assurance Cell  
Management & Technology For Women  
Vignan's **Co-ordinator IQAC**  
Kondapur (V), Ghatkesar (M), Medchal - Malkajgiri (D) - 501301  
Telangana State

  
PRINCIPAL

Vignan's Institute of Management & Technology For Women  
Kondapur(V), Ghatkesar(M), Medchal-Malkajgiri(D)-501301  
Telangana State

  
PRINCIPAL  
Vignan's Institute of Management & Technology For Women  
Kondapur(V), Ghatkesar(M), Medchal-Malkajgiri(D)-501301  
Telangana State



# VIGNAN'S INSTITUTE OF MANAGEMENT AND TECHNOLOGY FOR WOMEN

(Sponsored by Lawu Educational Society)

Approved by AICTE, New Delhi & Affiliated to JNTUJH, Hyderabad.

Kondapur (V), Ghatkesar (M), Medchal - Malkajgiri (D) - 501 301



## CERTIFICATE OF PARTICIPATION

This is to certify that Mr./Mrs. K. Prathyusha of CSE, Vignans Institute of management and Technology for women has participated in a WORKSHOP on "Overview of NAAC Accreditation and Assessment Process" held on 22<sup>nd</sup> October, 2022, Organized by IQAC, Vignans Institute of Management and Technology for Women.

*[Signature]*  
PRINCIPAL

Vignans Institute of Management & Technology For Women  
Kondapur (V), Ghatkesar (M), Medchal-Malkajgiri (D) - 501301  
Telangana State



*[Signature]*  
Co-ordinator  
Internal Quality Assurance & Management  
Vignans Institute of Management & Technology For Women  
Kondapur (V), Ghatkesar (M), Medchal-Malkajgiri (D) - 501301  
Telangana State

*[Signature]*  
PRINCIPAL  
Vignans Institute of Management & Technology For Women  
Kondapur (V), Ghatkesar (M), Medchal-Malkajgiri (D) - 501301  
Telangana State



# VIGNAN'S INSTITUTE OF MANAGEMENT AND TECHNOLOGY FOR WOMEN

(Sponsored by Lavu Educational Society)

Approved by AICTE, New Delhi & Affiliated to JNTUH, Hyderabad.

Kondapur (V), Ghatkesar (M), Medchal - Malkajgiri (D) - 501 301



## CERTIFICATE OF PARTICIPATION

This is to certify that Mr./Mrs./Ms. ✓ V. Sriisha  
of CSE, Vignans Institute of management and Technology for women  
has participated in a WORKSHOP on "Overview of NAAC Accreditation and Assessment Process" held on 22<sup>nd</sup> October, 2022, Organized by IQAC, Vignans Institute of Management and Technology for Women.

*ASHA*  
PRINCIPAL

Vignans Institute of Management & Technology For Women  
Kondapur(V), Ghatkesar(M), Medchal-Malkajgiri(D)-501301  
Telangana State



*[Signature]*  
Co-ordinator  
Internal Quality Assurance Cell  
Vignans Institute of Management & Technology For Women  
Kondapur(V), Ghatkesar(M), Medchal(Malkajgiri)(D)-501301  
Telangana State

Co-ordinator IQAC  
Vignans Institute of Management & Technology For Women  
Kondapur(V), Ghatkesar(M), Medchal(Malkajgiri)(D)-501301  
Telangana State

*[Signature]*  
Principal

Vignans Institute of Management & Technology For Women  
Kondapur(V), Ghatkesar(M), Medchal(Malkajgiri)(D)-501301  
Telangana State



# VIGNAN'S INSTITUTE OF MANAGEMENT AND TECHNOLOGY FOR WOMEN

(Sponsored by Lavu Educational Society)  
Approved by AICTE, New Delhi & Affiliated to JNTUH, Hyderabad.

Kondapur (V), Ghatkesar (M), Medchal - Malkajgiri (D) - 501 301



## CERTIFICATE OF PARTICIPATION

This is to certify that Mr./Mrs. Dr. Rajendra prasad panaganti  
of CSE, Vignan's Institute of management and Technology for women  
has participated in a WORKSHOP on "Overview of NAAC Accreditation and Assessment  
Process" held on 22<sup>nd</sup> October, 2022, Organized by IQAC, Vignan's Institute of  
Management and Technology for Women.

*Handwritten signature in green ink*  
PRINCIPAL

Vignan's Institute of Management & Technology for Women  
Kondapur (V), Ghatkesar (M), Medchal-Malkajgiri (D) - 501 301  
Telangana State

*Handwritten signature*  
Co-ordinator  
Co-ordinator Quality Assurance Cell  
Vignan's Institute of Management & Technology for Women  
Kondapur (V), Ghatkesar (M), Medchal-Malkajgiri (D) - 501 301  
Telangana State



*Handwritten signature*  
Principal  
Vignan's Institute of Management & Technology for Women  
Kondapur (V), Ghatkesar (M), Medchal-Malkajgiri (D) - 501 301  
Telangana State





# VIGNAN'S INSTITUTE OF MANAGEMENT AND TECHNOLOGY FOR WOMEN

(Sponsored by Lawu Educational Society)  
Approved by AICTE, New Delhi & Affiliated to JNTUH, Hyderabad.

Kondapur (V), Ghatkesar (M), Medchal - Malkajgiri (D) - 501 301



## CERTIFICATE OF PARTICIPATION

This is to certify that Mr./Ms./Mrs. Dr. Ch. Basava Raj  
of CSE, Vignans Institute of management and Technology for women  
has participated in a WORKSHOP on "Overview of NAAC Accreditation and Assessment  
Process" held on 22<sup>nd</sup> October, 2022, Organized by IQAC, Vignans Institute of  
Management and Technology for Women.



  
Coordinator  
Internal Quality Assurance Cell  
Vignans Institute of Management & Technology for Women  
Kondapur (V), Ghatkesar (M), Medchal - Malkajgiri (D) - 501301  
Telangana State

  
PRINCIPAL  
Vignans Institute of Management & Technology for Women  
Kondapur (V), Ghatkesar (M), Medchal - Malkajgiri (D) - 501301  
Telangana State

Principal

Vignans Institute of Management & Technology for Women



VIGNAN'S INSTITUTE OF MANAGEMENT AND TECHNOLOGY FOR WOMEN

TECHNOLOGY FOR WOMEN

(Sponsored by Lawu Educational Society)

Approved by AICTE, New Delhi & Affiliated to JNTUH, Hyderabad.

Kondapur (V), Ghatkesar (M), Medchal - Malkajgiri (D) - 501 301



# CERTIFICATE OF PARTICIPATION

This is to certify that Mr./Ms. ✓ Indrani Vasireddy of CSE, Vignan's Institute of management and Technology for women has participated in a WORKSHOP on "Overview of NAAC Accreditation and Assessment Process" held on 22<sup>nd</sup> October, 2022, Organized by IQAC, Vignan's Institute of Management and Technology for Women.

*aan*  
PRINCIPAL

Vignan's Institute of Management & Technology For Women  
Ghatkesar (M), Medchal-Malkajgiri (D)-501301  
Telangana State

*[Signature]*  
Co-ordinator, IQAC  
Vignan's Institute of Management & Technology For Women  
Ghatkesar (M), Medchal-Malkajgiri (D)-501301  
Telangana State



*[Signature]*  
Principal, Management & Technology For Women  
Vignan's Institute of Management & Technology For Women  
Ghatkesar (M), Medchal-Malkajgiri (D)-501301  
Telangana State



# VIGNAN'S INSTITUTE OF MANAGEMENT AND TECHNOLOGY FOR WOMEN

(Sponsored by Lawu Educational Society)

Approved by AICTE, New Delhi & Affiliated to JNTUJH, Hyderabad.

Kondapur (V), Ghatkesar (M), Medchal - Malkajgiri (D) - 501 301



## CERTIFICATE OF PARTICIPATION

This is to certify that Mr./Mrs. Vishnu Vardhana Rao Moram  
of CSE, Vignans Institute of management and Technology for women  
has participated in a WORKSHOP on "Overview of NAAC Accreditation and Assessment  
Process" held on 22<sup>nd</sup> October, 2022, Organized by IQAC, Vignans Institute of  
Management and Technology for Women.

  
PRINCIPAL

Vignans Institute of Management & Technology for Women  
Kondapur (V), Ghatkesar (M), Medchal-Malkajgiri (D) - 501 301  
Telangana State

  
Co-ordinator  
Internal Quality Assurance Cell  
Vignans Institute of Management & Technology for Women  
Kondapur (V), Ghatkesar (M), Medchal-Malkajgiri (D) - 501 301  
Telangana State



  
Principa PRINCIPAL  
Vignans Institute of Management & Technology for Women  
Kondapur (V), Ghatkesar (M), Medchal-Malkajgiri (D) - 501 301  
Telangana State



# VIGNAN'S INSTITUTE OF MANAGEMENT AND TECHNOLOGY FOR WOMEN

(Sponsored by Lavu Educational Society)  
Approved by AICTE, New Delhi & Affiliated to JNTUH, Hyderabad.

Kondapur (V), Ghatkesar (M), Medchal - Malkajgiri (D) - 501 301



## CERTIFICATE OF PARTICIPATION

This is to certify that Mr./Mrs. Ravi Surarapu  
of CSE, Vignans Institute of management and Technology for women  
has participated in a WORKSHOP on "Overview of NAAC Accreditation and Assessment  
Process" held on 22<sup>nd</sup> October, 2022, Organized by IQAC, Vignans Institute of  
Management and Technology for Women.

*Handwritten signature*

PRINCIPAL

Vignans Institute of Management & Technology for Women  
Kondapur (V), Ghatkesar (M), Medchal-Malkajgiri (D) - 501301  
Telangana State

*Handwritten signature*  
Co-ordinator  
Internal Quality Assurance Cell  
Management & Technology for Women  
Kondapur (V), Ghatkesar (M), Medchal-Malkajgiri (D) - 501301  
Telangana State

Co-ordinator IQAC  
Vignans Institute of Management & Technology for Women  
Kondapur (V), Ghatkesar (M), Medchal-Malkajgiri (D) - 501301  
Telangana State



*Handwritten signature*  
Principal  
Vignans Institute of Management & Technology for Women  
Kondapur (V), Ghatkesar (M), Medchal-Malkajgiri (D) - 501301  
Telangana State



# VIGNAN'S INSTITUTE OF MANAGEMENT AND TECHNOLOGY FOR WOMEN

(Sponsored by Lavu Educational Society)

Approved by AICTE, New Delhi & Affiliated to JNTUH, Hyderabad.

Kondapur (V), Ghatkesar (M), Medchal - Malkajgiri (D) - 501 301



## CERTIFICATE OF PARTICIPATION

This is to certify that Mr./Mrs. G. Ksanthi Kshari  
of CSE, Vignans Institute of management and Technology for women  
has participated in a WORKSHOP on "Overview of NAAC Accreditation and Assessment  
Process" held on 22<sup>nd</sup> October, 2022, Organized by IQAC, Vignans Institute of  
Management and Technology for Women

*[Signature]*  
PRINCIPAL

Vignans Institute of Management & Technology for Women  
Kondapur(V), Ghatkesar(M), Medchal-Malkajgiri(D)-501301  
Telangana State

*[Signature]*  
Co-ordinator  
Internal Quality Assurance Cell  
Management & Technology for Women  
Vignans Institute of Management & Technology for Women  
Kondapur(V), Ghatkesar(M), Medchal-Malkajgiri(D)-501301  
Telangana State



*[Signature]*  
PRINCIPAL

Vignans Institute of Management & Technology for Women  
Kondapur(V), Ghatkesar(M), Medchal-Malkajgiri(D)-501301  
Telangana State



# VIGNAN'S INSTITUTE OF MANAGEMENT AND TECHNOLOGY FOR WOMEN

(Sponsored by Lavu Educational Society)

Approved by AICTE, New Delhi & Affiliated to JNTUH, Hyderabad.

Kondapur (M), Ghatkesar (M), Medchal - Malkajgiri (D) - 501 301



## CERTIFICATE OF PARTICIPATION

This is to certify that Mr./Ms./Mrs. Ch. Sunil  
of CSE, Vignans Institute of management and Technology for women  
has participated in a WORKSHOP on "Overview of NAAC Accreditation and Assessment Process" held on 22<sup>nd</sup> October, 2022, Organized by IQAC, Vignans Institute of Management and Technology for Women.

  
PRINCIPAL  
Vignans Institute of Management & Technology For Women  
Ghatkesar(M), Ghatkesar(M), Medchal-Malkajgiri(D)-501301  
Telangana State

  
Co-ordinator  
Internal Quality Assurance  
Cell  
Vignans Institute of Management & Technology For Women  
Ghatkesar (M), Medchal - Malkajgiri (D) - 501301  
Telangana State



  
PRINCIPAL  
Vignans Institute of Management & Technology For Women  
Ghatkesar (M), Medchal - Malkajgiri (D) - 501301



# VIGNAN'S INSTITUTE OF MANAGEMENT AND TECHNOLOGY FOR WOMEN

(Sponsored by Lawu Educational Society)

Approved by AICTE, New Delhi & Affiliated to JNTUH, Hyderabad.

Kondapur (V), Ghatkesar (M), Medchal - Malkajgiri (D) - 501 301



## CERTIFICATE OF PARTICIPATION

This is to certify that Mr./Ms./Mrs. L. Suresh  
of CSE, Vignan's Institute of Management and Technology for Women  
has participated in a WORKSHOP on "Overview of NAAC Accreditation and Assessment  
Process" held on 22<sup>nd</sup> October, 2022, Organized by IQAC, Vignan's Institute of  
Management and Technology for Women.

*Handwritten signature in green ink.*

*Handwritten signature in blue ink.*  
Co-ordinator  
National Quality Assurance Cell  
(Management & Technology) For Women  
Kondapur (V), Ghatkesar (M), Medchal - Malkajgiri (D) - 501301

*Handwritten signature in blue ink.*  
Principal





# VIGNAN'S INSTITUTE OF MANAGEMENT AND TECHNOLOGY FOR WOMEN

(Sponsored by Lavu Educational Society)

Approved by AICTE, New Delhi & Affiliated to JNTUH, Hyderabad.

Kondapur (V), Ghatkesar (M), Medchal - Malkajgiri (D) - 501 301



## CERTIFICATE OF PARTICIPATION

This is to certify that Mr./Ms./Mrs. B. Mamatha of CSE, Vignans Institute of management and Technology for women has participated in a WORKSHOP on "Overview of NAAC Accreditation and Assessment Process" held on 22<sup>nd</sup> October, 2022. Organized by IQAC, Vignans Institute of Management and Technology for Women.



  
Co-ordinator  
Co-ordinator Quality Assurance Cell  
Management & Technology For Women  
Vignans Institute of Management & Technology For Women  
Kondapur (V), Ghatkesar (M), Medchal-Malkajgiri (D) - 501301  
Principal  
Vignans Institute of Management & Technology For Women  
Kondapur (V), Ghatkesar (M), Medchal-Malkajgiri (D) - 501301  
Telangana State





# VIGNAN'S INSTITUTE OF MANAGEMENT AND TECHNOLOGY FOR WOMEN

(Sponsored by Lawu Educational Society)  
Approved by AICTE, New Delhi & Affiliated to JNTUH, Hyderabad.

Kondapur (V), Ghatkesar (M), Medchal - Malkajgiri (D) - 501 301



## CERTIFICATE OF PARTICIPATION

This is to certify that Mr./Ms./Mrs. Dr. S. Gayathri  
of ECE, Vignan's Institute of management and Technology for women  
has participated in a WORKSHOP on "Overview of NAAC Accreditation and Assessment  
Process" held on 22<sup>nd</sup> October, 2022, Organized by IQAC, Vignan's Institute of  
Management and Technology for Women.

  
Coordinator  
Internal Quality Assurance Cell





Co-ordinator, IQAC, Vignan's Institute of Management & Technology For Women  
Kondapur (V), Ghatkesar (M), Medchal-Malkajgiri (D) - 501301  
Telangana State  
PRINCIPAL  
Principal



VIGNANS INSTITUTE OF MANAGEMENT AND

TECHNOLOGY FOR WOMEN

(Sponsored by Lawu Educational Society)

Approved by AICTE, New Delhi & Affiliated to JNTUH, Hyderabad.

Kondapur (V), Ghatkesar (M), Medchal - Malkajgiri (D) - 501 301



### CERTIFICATE OF PARTICIPATION

This is to certify that Mr./Ms./Mrs. Dr. Krishnamoorthy Raja of ECE, Vignans Institute of management and Technology for women has participated in a WORKSHOP on "Overview of NAAC Accreditation and Assessment Process" held on 22<sup>nd</sup> October, 2022, Organized by IQAC, Vignans Institute of Management and Technology for Women.

  
Co-ordinator  
Vignans Institute of Management & Technology for Women  
Kondapur (V), Ghatkesar (M), Medchal - Malkajgiri (D) - 501 301



  
PRINCIPAL  
Vignans Institute of Management & Technology for Women  
Kondapur (V), Ghatkesar (M), Medchal - Malkajgiri (D) - 501 301  
Telangana State



# VIGNAN'S INSTITUTE OF MANAGEMENT AND TECHNOLOGY FOR WOMEN

(Sponsored by Lawu Educational Society)

Approved by AICTE, New Delhi & Affiliated to JNTUH, Hyderabad.

Kondapur (M), Ghatkesar (M), Medchal - Malkajgiri (D) - 501 301

Accredited By



NATIONAL BOARD OF ACCREDITATION

CSE & ECE

## CERTIFICATE OF PARTICIPATION

This is to certify that Mr./Ms./Mrs. Dr. Vijay Kumar R Urkude of ECE, Vignans Institute of management and Technology for women has participated in a WORKSHOP on "Overview of NAAC Accreditation and Assessment Process" held on 22<sup>nd</sup> October, 2022, Organized by IQAC, Vignans Institute of Management and Technology for Women.

  
Co-ordinator  
Internal Quality Assurance Cell  
Management & Technology For Women  
Vignans Institute of Management & Technology (D), 501301  
Co-ordinator IQAC



  
PRINCIPAL

Vignans Institute of Management & Technology For Women  
Landmark VI, Ghatkesar (M), Medchal-Malkajgiri (D) - 501301  
Telangana State



Principa PRINCIPAL  
Management & Technology For Women  
Vignans Institute of Management & Technology For Women



# VIGNAN'S INSTITUTE OF MANAGEMENT AND TECHNOLOGY FOR WOMEN

(Sponsored by Lavu Educational Society)  
Approved by AICTE, New Delhi & Affiliated to JNTUH, Hyderabad.

Kondapur (V), Ghatkesar (M), Medchal - Malkajgiri (D) - 501 301



## CERTIFICATE OF PARTICIPATION

This is to certify that Mr./Ms./Mrs. Dr. Masthan Basha Shaik  
of ECE, Vignans Institute of management and Technology for women  
has participated in a WORKSHOP on "Overview of NAAC Accreditation and Assessment  
Process" held on 22<sup>nd</sup> October, 2022, Organized by IQAC, Vignans Institute of  
Management and Technology for Women.

*Handwritten signature*  
PRINCIPAL

Vignans Institute of Management & Technology for Women  
Varesepur(V), Ghatkesar(M), Medchal-Malkajgiri(D)-501301  
Telangana State

*Handwritten signature*  
Co-ordinator  
Internal Quality Assurance Cell  
Management & Technology for Women  
Vignans Institute of Management & Technology for Women  
Kondapur (V), Ghatkesar (M), Medchal - Malkajgiri (D) - 501301

Co-ordinator IQAC



*Handwritten signature*  
Principal  
Vignans Institute of Management & Technology for Women  
Kondapur (V), Ghatkesar (M), Medchal - Malkajgiri (D) - 501301



# VIGNAN'S INSTITUTE OF MANAGEMENT AND TECHNOLOGY FOR WOMEN

(Sponsored by Lavu Educational Society)  
Approved by AICTE, New Delhi & Affiliated to JNTUH, Hyderabad.

Kondapur (V), Ghatkesar (M), Medchal - Malkajgiri (D) - 501 301



## CERTIFICATE OF PARTICIPATION

This is to certify that *Mr./Ms./Mrs. Hari Krishna Pannam* of *ECE, Vignans Institute of management and Technology for women* has participated in a WORKSHOP on "Overview of NAAC Accreditation and Assessment Process" held on 22<sup>nd</sup> October, 2022, Organized by IQAC, Vignans Institute of Management and Technology for Women.

*NAAC*

PRINCIPAL

Vignans Institute of Management & Technology For Women  
Kondapur(V), Ghatkesar(M), Medchal-Malkajgiri(D)-501301  
Telangana State

*[Signature]*  
Co-ordinator  
Quality Assurance Cell  
Management & Technology For Women  
Vignans Institute of Management & Technology For Women

*[Signature]*

PRINCIPAL

Vignans Institute of Management & Technology For Women  
Kondapur(V), Ghatkesar(M), Medchal-Malkajgiri(D)-501301  
Telangana State





# VIGNAN'S INSTITUTE OF MANAGEMENT AND TECHNOLOGY FOR WOMEN

(Sponsored by Lavu Educational Society)

Approved by AICTE, New Delhi & Affiliated to JNTUJH, Hyderabad.

Kondapur (V), Ghatkesar (M), Medchal - Malkajgiri (D) - 501 301



## CERTIFICATE OF PARTICIPATION

This is to certify that Mr./Ms./Mrs. Sunil Kumar Tangili of ECE, Vignans Institute of management and Technology for women has participated in a WORKSHOP on "Overview of NAAC Accreditation and Assessment Process" held on 22<sup>nd</sup> October, 2022, Organized by IQAC, Vignans Institute of Management and Technology for Women.

*NAAC*

  
Co-ordinator  
Assurance Cell  
Vignans Institute of Management & Technology for Women  
Kondapur(V), Ghatkesar(M), Medchal-Malkajgiri(D)-501301  
Telangana State

PRINCIPAL

  
PRINCIPAL  
Vignans Institute of Management & Technology for Women  
Kondapur(V), Ghatkesar(M), Medchal-Malkajgiri(D)-501301  
Telangana State



PRINCIPAL  
Vignans Institute of Management & Technology for Women  
Kondapur(V), Ghatkesar(M), Medchal-Malkajgiri(D)-501301  
Telangana State



# VIGNAN'S INSTITUTE OF MANAGEMENT AND TECHNOLOGY FOR WOMEN

(Sponsored by Lawu Educational Society)

Approved by AICTE, New Delhi & Affiliated to JNTUH, Hyderabad.

Kondapur (V), Ghatkesar (M), Medchal - Malkajgiri (D) - 501 301

Accredited By



NATIONAL BOARD OF ACCREDITATION

CSE & ECE

## CERTIFICATE OF PARTICIPATION

This is to certify that Mr./Ms./Mrs. T. Pullaiah of ECE, Vignana's Institute of management and Technology for women has participated in a WORKSHOP on "Overview of NAAC Accreditation and Assessment Process" held on 22<sup>nd</sup> October, 2022, Organized by IQAC, Vignana's Institute of Management and Technology for Women.

*PRINCIPAL*

Vignana's Institute of Management & Technology For Women  
Kondapur(V), Ghatkesar(M), Medchal-Malkajgiri(D)-501301  
Telangana State

*Coordinator*  
Internal Quality Assurance Cell



*PRINCIPAL*

Vignana's Institute of Management & Technology For Women  
Kondapur(V), Ghatkesar(M), Medchal-Malkajgiri(D)-501301  
Telangana State



# VIGNAN'S INSTITUTE OF MANAGEMENT AND TECHNOLOGY FOR WOMEN

(Sponsored by Lawu Educational Society)

Approved by AICTE, New Delhi & Affiliated to JNTUH, Hyderabad.

Kondapur (V), Ghatkesar (M), Medchal - Malkajgiri (D) - 501 301



## CERTIFICATE OF PARTICIPATION

This is to certify that Mr./Mrs. Ashok Reddy Katta  
of ECE, Vignans Institute of management and Technology for women  
has participated in a WORKSHOP on "Overview of NAAC Accreditation and Assessment Process" held on 22<sup>nd</sup> October, 2022. Organized by IQAC, Vignans Institute of Management and Technology for Women.

PRINCIPAL

Vignans Institute of Management & Technology For Women  
Kondapur(V), Ghatkesar(M), Medchal-Malkajgiri(D)-501301  
Telangana State

Co-ordinator  
Internal Quality Assurance Cell  
Management & Technology For Women  
Kondapur (V) - Malkajgiri (D) - 501301

Co-ordinator, IQAC

Principal  
PRINCIPAL

Vignans Institute of Management & Technology For Women  
Kondapur(V), Ghatkesar(M), Medchal-Malkajgiri(D)-501301  
Telangana State







# VIGNAN'S INSTITUTE OF MANAGEMENT AND TECHNOLOGY FOR WOMEN

(Sponsored by Lawu Educational Society)

Approved by AICTE, New Delhi & Affiliated to JNTUJH, Hyderabad.

Kondapur (V), Ghatkesar (M), Medchal - Malkajgiri (D) - 501 301



CSE & ECE

## CERTIFICATE OF PARTICIPATION

This is to certify that Mr./Mrs. Burugu Mahesh  
of ECE, Vignans Institute of management and Technology for women  
has participated in a WORKSHOP on "Overview of NAAC Accreditation and Assessment Process" held on 22<sup>nd</sup> October, 2022, Organized by IQAC, Vignans Institute of Management and Technology for Women.

*[Signature]*  
Co-ordinator  
Co-ordinator Quality Assurance Cell  
Management & Technology For Women  
Kondapur (V), Ghatkesar (M), Medchal-Malkajgiri (D)-501301  
Telangana State  
**PRINCIPAL**  
Vignans Institute of Management & Technology For Women  
Kondapur(V), Ghatkesar(M), Medchal-Malkajgiri(D)-501301  
Telangana State





# VIGNAN'S INSTITUTE OF MANAGEMENT AND TECHNOLOGY FOR WOMEN

(Sponsored by Lawu Educational Society)

Approved by AICTE, New Delhi & Affiliated to JNTUH, Hyderabad.

Kondapur (V), Ghatkesar (M), Medchal - Malkajgiri (D) - 501 301



CSE & ECE

## CERTIFICATE OF PARTICIPATION

This is to certify that Mr./Mrs. G. Ganesh Reddy  
of ECE, Vignans Institute of management and Technology for women  
has participated in a WORKSHOP on "Overview of NAAC Accreditation and Assessment Process" held on 22<sup>nd</sup> October, 2022, Organized by IQAC, Vignans Institute of Management and Technology for Women.



  
Co-ordinator  
Internal Quality Assurance Cell  
Vignans Institute of Management & Technology For Women

  
Principal  
Principal  
Vignans Institute of Management & Technology For Women  
Kondapur(V), Ghatkesar(M), Medchal-Malkajgiri(D)-501301  
Telangana State



# VIGNAN'S INSTITUTE OF MANAGEMENT AND TECHNOLOGY FOR WOMEN

(Sponsored by Lavu Educational Society)

Approved by AICTE, New Delhi & Affiliated to JNTUH, Hyderabad.

Kondapur (V), Ghatkesar (M), Medchal - Malkajgiri (D) - 501 301

Accredited By



NATIONAL BOARD OF ACCREDITATION



## CERTIFICATE OF PARTICIPATION

This is to certify that Mr./Ms./Mrs. KarthiKpal Maddikunta of ECE, Vignan's Institute of management and Technology for women has participated in a WORKSHOP on "Overview of NAAC Accreditation and Assessment Process" held on 22<sup>nd</sup> October, 2022, Organized by IQAC, Vignan's Institute of Management and Technology for Women.



*[Signature]*  
Co-ordinator  
Co-ordinator  
Quality Assurance Cell  
Management & Technology For Women  
Vignan's Institute of Management & Technology (D)-501301  
Kondapur (V), Ghatkesar (M), Medchal - Malkajgiri (D)  
Telangana State

*[Signature]*  
PRINCIPAL  
Vignan's Institute of Management & Technology For Women  
Kondapur (V), Ghatkesar (M), Medchal - Malkajgiri (D)-501301  
Telangana State

*[Signature]*  
Principal  
Vignan's Institute of Management & Technology For Women  
Kondapur (V), Ghatkesar (M), Medchal - Malkajgiri (D)-501301  
Telangana State



# VIGNAN'S INSTITUTE OF MANAGEMENT AND TECHNOLOGY FOR WOMEN

(Sponsored by Lawu Educational Society)

Approved by AICTE, New Delhi & Affiliated to JNTUH, Hyderabad.

Kondapur (V), Ghatkesar (M), Medchal - Malkajgiri (D) - 501 301

Accredited By



NATIONAL BOARD OF ACCREDITATION



## CERTIFICATE OF PARTICIPATION

This is to certify that Mr./Ms./Mrs. Nagaraju Eduuru  
of ECE, Vignans Institute of management and Technology for women  
has participated in a WORKSHOP on "Overview of NAAC Accreditation and Assessment Process" held on 22<sup>nd</sup> October, 2022, Organized by IQAC, Vignans Institute of Management and Technology for Women.



*NASH*  
PRINCIPAL  
Vignans Institute of Management & Technology for Women  
Kondapur(V), Ghatkesar(M), Medchal-Malkajgiri(D)-501301  
Telangana State

*NASH*  
Co-ordinator  
Co-ordinator Quality Assurance Cell  
Vignans Institute of Management & Technology for Women  
Kondapur(V), Ghatkesar(M), Medchal-Malkajgiri(D)-501301  
Telangana State

**Co-ordinator IQAC**  
Vignans Institute of Management & Technology for Women  
Kondapur (V), Ghatkesar (M), Medchal - Malkajgiri (D) - 501 301  
Telangana State

*NASH*  
**Principal**  
Vignans Institute of Management & Technology for Women  
Kondapur (V), Ghatkesar (M), Medchal - Malkajgiri (D) - 501 301  
Telangana State



# VIGNAN'S INSTITUTE OF MANAGEMENT AND TECHNOLOGY FOR WOMEN

(Sponsored by Lavu Educational Society)

Approved by AICTE, New Delhi & Affiliated to JNTUH, Hyderabad.

Kondapur (V), Ghatkesar (M), Medchal - Malkajgiri (D) - 501 301

Accredited By



NATIONAL BOARD  
ACCREDITATION



## CERTIFICATE OF PARTICIPATION

This is to certify that Mr./Ms./Mrs. Gangula Swathi  
of ECE, Vignans Institute of management and Technology for women

has participated in a WORKSHOP on "Overview of NAAC Accreditation and Assessment Process" held on 22<sup>nd</sup> October, 2022, Organized by IQAC, Vignans Institute of Management and Technology for Women.



*[Signature]*  
Coordinator

Internal Quality Assurance Cell  
**Coordinator IQAC**  
Vignans Institute of Management & Technology for Women  
Kondapur (V), Ghatkesar (M), Medchal-Malkajgiri (D)-501301  
Telangana State

*[Signature]*  
**PRINCIPAL**  
Vignans Institute of Management & Technology for Women  
Kondapur (V), Ghatkesar (M), Medchal-Malkajgiri (D)-501301  
Telangana State

*[Signature]*  
**Principal**

Vignans Institute of Management & Technology for Women

Vignans Institute of Management & Technology for Women



# VIGNANS INSTITUTE OF MANAGEMENT AND TECHNOLOGY FOR WOMEN

(Sponsored by Lavu Educational Society)

Approved by AICTE, New Delhi & Affiliated to JNTUH, Hyderabad.

Kondapur (V), Ghatkesar (M), Medchal - Malkajgiri (D) - 501 301

Accredited By



NATIONAL BOARD OF ACCREDITATION

CSE & ECE

## CERTIFICATE OF PARTICIPATION

This is to certify that Mr./Ms./Mrs. Vinod Kumar Bixyala of ECE, Vignans Institute of management and Technology for women has participated in a WORKSHOP on "Overview of AAC Accreditation and Assessment process" held on 22<sup>nd</sup> October, 2022, Organized by IQAC, Vignans Institute of Management and Technology for Women.



PRINCIPAL

Vignans Institute of Management & Technology for Women  
Kondapur(V), Ghatkesar(M), Medchal-Malkajgiri(D)-501301  
Telangana State

Co-ordinator

Internal Quality Assurance Cell

Vignans Institute of Management & Technology for Women

Kondapur (V), Ghatkesar (M), Medchal-Malkajgiri (D)-501301

Telangana State

Principal

Vignans Institute of Management & Technology for Women



# TECHNOLOGY FOR WOMEN

(Sponsored by Lawu Educational Society)  
Approved by AICTE, New Delhi & Affiliated to JNTUH, Hyderabad.  
Kondapur (V), Ghatkesar (M), Medchal - Malkajgiri (D) - 501 301



NATIONAL BOARD  
OF ACCREDITATION



## CERTIFICATE OF PARTICIPATION

This is to certify that Mr./Ms./Mrs. Usharani Narasingam  
of ECE, Vignan's Institute of management and Technology for women  
has participated in a WORKSHOP on "Overview of NAAC Accreditation and Assessment  
Process held on 22<sup>nd</sup> October 2022, Organized by IQAC, Vignan's Institute of  
Management and Technology for Women.



*[Signature]*  
Co-ordinator, IQAC  
Vignan's Institute of Management & Technology For Women  
Kondapur (V), Ghatkesar (M), Medchal-Malkajgiri (D) - 501301  
T.S.

*[Signature]*  
PRINCIPAL

Vignan's Institute of Management & Technology For Women  
Kondapur (V), Ghatkesar (M), Medchal-Malkajgiri (D) - 501 301  
Telangana State

*[Signature]*  
Principal

Vignan's Institute of Management & Technology For Women  
Kondapur (V), Ghatkesar (M), Medchal-Malkajgiri (D) - 501301  
Telangana State



# TECHNOLOGY FOR WOMEN

(Sponsored by Lawu Educational Society)

Approved by AICTE, New Delhi & Affiliated to JNTUH, Hyderabad.

Kondapur (V), Ghatkesar (M), Medchal - Malkajgiri (D) - 501 301



NATIONAL BOARD  
OF ACCREDITATION



## CERTIFICATE OF PARTICIPATION

This is to certify that Mr./Ms./Mrs. Nareesh Chunchu  
of ECE, Vignan's Institute of management and Technology for women  
has participated in a WORKSHOP on "Overview of NAAC Accreditation and Assessment  
Process" held on 22<sup>nd</sup> October 2022. Organized by IQAC, Vignan's Institute of  
Management and Technology for Women.



*[Signature]*  
Co-ordinator  
Quality Assurance Cell  
Vignan's Institute of Management & Technology For Women  
Kondapur (V), Ghatkesar (M), Medchal - Malkajgiri (D) - 501 301  
T.S.

*[Signature]*  
PRINCIPAL  
Vignan's Institute of Management & Technology For Women  
Kondapur (V), Ghatkesar (M), Medchal - Malkajgiri (D) - 501 301  
Telangana State

*[Signature]*  
Principal  
Vignan's Institute of Management & Technology For Women  
Kondapur (V), Ghatkesar (M), Medchal - Malkajgiri (D) - 501 301  
Telangana State





# VIGNAN'S INSTITUTE OF MANAGEMENT AND TECHNOLOGY FOR WOMEN

(Sponsored by Lavu Educational Society)  
Approved by AICTE, New Delhi & Affiliated to JNTUH, Hyderabad.

Kondapur (V), Ghatkesar (M), Medchal - Malkajgiri (D) - 501 301

Accredited By



NATIONAL BOARD  
OF ACCREDITATION



## CERTIFICATE OF PARTICIPATION

This is to certify that Mr./Ms./Mrs. Hemalatha Maddigatla  
of ECE, Vignans Institute of management and Technology for women  
has participated in a WORKSHOP on "Overview of IQAC Accreditation and Assessment  
Process" held on 22<sup>nd</sup> October, 2022, Organized by IQAC, Vignans Institute of  
Management and Technology for Women.



*[Signature]* Co-ordinator  
Internal Quality Assurance Cell  
Vignans Institute of Management & Technology For Women  
Kondapur (V), Ghatkesar (M), Medchal-Malkajgiri (D)-501301  
**Co-ordinator, IQAC**  
Telangana State

*[Signature]*

**PRINCIPAL**  
Vignans Institute of Management & Technology For Women  
Kondapur (V), Ghatkesar (M), Medchal-Malkajgiri (D)-501301  
Telangana State

*[Signature]*

**Principal**  
Vignans Institute of Management & Technology For Women  
Kondapur (V), Ghatkesar (M), Medchal-Malkajgiri (D)-501301  
Telangana State



# VIGNAN'S INSTITUTE OF MANAGEMENT AND TECHNOLOGY FOR WOMEN

(Sponsored by Lavu Educational Society)

Approved by AICTE, New Delhi & Affiliated to JNTUH, Hyderabad.

Kondapur (V), Ghatkesar (M), Medchal - Malkajgiri (D) - 501 301

Accredited By



NATIONAL BOARD  
ACCREDITATION



## CERTIFICATE OF PARTICIPATION

This is to certify that Mr./Ms./Mrs. Nagaraju Eduuru  
of ECE, Vignans Institute of management and Technology for women  
has participated in a WORKSHOP on "Overview of NAAC Accreditation and Assessment  
Process" held on 22<sup>nd</sup> October, 2022, Organized by IQAC, Vignans Institute of  
Management and Technology for Women.



*[Signature]* Co-ordinator  
Internal Quality Assurance Cell  
(Department of Management & Technology) For Women  
Vignans Institute of Management & Technology  
Kondapur (V), Ghatkesar (M), Medchal - Malkajgiri (D) - 501301  
T.S.

*[Signature]*  
PRINCIPAL  
Vignans Institute of Management & Technology For Women  
(Kondapur(V), Ghatkesar(M), Medchal-Malkajgiri(D)-501301)  
Telangana State

*[Signature]*  
Principal  
Vignans Institute of Management & Technology For Women  
(Kondapur(V), Ghatkesar(M), Medchal-Malkajgiri(D)-501301)  
Telangana State



# VIGNAN'S INSTITUTE OF MANAGEMENT AND TECHNOLOGY FOR WOMEN

(Sponsored by Lavu Educational Society)

Approved by AICTE, New Delhi & Affiliated to JNTUH, Hyderabad.

Kondapur (V), Ghatkesar (M), Medchal - Malkajgiri (D) - 501 301

Accredited By



NATIONAL BOARD OF ACCREDITATION



## CERTIFICATE OF PARTICIPATION

This is to certify that Mr./Ms./Mrs. Kiran Kumar Lanka of EEE, Vignans Institute of management and Technology for women has participated in a WORKSHOP on "Overview of NAAC Accreditation and Assessment Process" held on 22<sup>nd</sup> October 2022, Organized by IQAC, Vignans Institute of Management and Technology for Women.



*[Signature]*  
Co-ordinator  
Internal Quality Assurance Cell  
Vignans Institute of Management & Technology For Women  
Medchal-Malkajgiri (D)-501301  
**Co-ordinator IQAC**  
Vignans Institute of Management & Technology For Women  
Kondapur (V) Medchal-Malkajgiri (D)

*[Signature]*

**PRINCIPAL**  
Vignans Institute of Management & Technology For Women  
Kondapur (V), Ghatkesar (M), Medchal-Malkajgiri (D)-501301  
Telangana State

*[Signature]*

**Principal**  
Vignans Institute of Management & Technology For Women  
Kondapur (V), Ghatkesar (M), Medchal-Malkajgiri (D)-501301  
Telangana State



# VIGNAN'S INSTITUTE OF MANAGEMENT AND TECHNOLOGY FOR WOMEN

(Sponsored by Lavu Educational Society)

Approved by AICTE, New Delhi & Affiliated to JNTUH, Hyderabad.

Kondapur (V), Ghatkesar (M), Medchal - Malkajgiri (D) - 501 301

Accredited By



NATIONAL BOARD OF ACCREDITATION



## CERTIFICATE OF PARTICIPATION

This is to certify that Mr./Ms./Mrs. Kumari Kandukuril of EEE, Vignan's Institute of management and Technology for women has participated in a WORKSHOP on "Overview of NAAC Accreditation and Assessment Process" held on 22<sup>nd</sup> October, 2022, Organized by IQAC, Vignan's Institute of Management and Technology for Women.



*[Signature]* Co-ordinator  
Internal Quality Assurance Cell  
Vignan's Institute of Management & Technology For Women  
Kondapur (V), Ghatkesar (M), Medchal-Malkajgiri (D)-501301  
**Co-ordinator, IQAC**  
T.S.

*[Signature]*  
PRINCIPAL  
Vignan's Institute of Management & Technology For Women  
Kondapur (V), Ghatkesar (M), Medchal-Malkajgiri (D)-501301  
Telangana State

*[Signature]*  
Principal  
Vignan's Institute of Management & Technology For Women  
Kondapur (V), Ghatkesar (M), Medchal-Malkajgiri (D)-501301  
Telangana State



# VIGNAN'S INSTITUTE OF MANAGEMENT AND TECHNOLOGY FOR WOMEN

Accredited By



(Sponsored by Lawu Educational Society)

Approved by AICTE, New Delhi & Affiliated to JNTUH, Hyderabad.

Kondapur (V), Ghatkesar (M), Medchal - Malkajgiri (D) - 501 301

NEW DELHI  
INDIA



## CERTIFICATE OF PARTICIPATION

This is to certify that Mr./Ms./Mrs. Rambabu Thatikayala  
of EEE, Vignan's Institute of management and Technology for women  
has participated in a WORKSHOP on "Overview of IQAC Accreditation and Assessment  
Process" held on 22<sup>nd</sup> October, 2022, Organized by IQAC, Vignan's Institute of  
Management and Technology for Women.



PRINCIPAL

Vignan's Institute of Management & Technology for Women  
Kondapur (V), Ghatkesar (M), Medchal-Malkajgiri (D)-501301  
Telangana State

[Signature]  
Co-ordinator  
Internal Quality Assurance Cell  
Management & Technology For Women  
Kondapur (V), Ghatkesar (M), Medchal - Malkajgiri (D) - 501301  
Telangana State

[Signature]  
PRINCIPAL  
Vignan's Institute of Management & Technology for Women  
Kondapur (V), Ghatkesar (M), Medchal-Malkajgiri (D)-501301  
Telangana State



VIGNAN'S INSTITUTE OF MANAGEMENT AND TECHNOLOGY FOR WOMEN

**TECHNOLOGY FOR WOMEN**

(Sponsored by Lavu Educational Society)

Approved by AICTE, New Delhi & Affiliated to JNTUH, Hyderabad.

Kondapur (V), Ghatkesar (M), Medchal - Malkajgiri (D) - 501 301



**CERTIFICATE OF PARTICIPATION**

This is to certify that Mr./Ms./Mrs. V. Maddileti Reddy of AIML, Vignan's Institute of management and Technology for women has participated in a WORKSHOP on "Overview of NAAC Accreditation and Assessment Process" held on 22<sup>nd</sup> October, 2022, Organized by IQAC, Vignan's Institute of Management and Technology for Women.

*[Signature]*  
PRINCIPAL

Vignan's Institute of Management & Technology for Women  
Kondapur(V), Ghatkesar(M), Medchal-Malkajgiri(D)-501301  
Telangana State

*[Signature]*  
Co-ordinator

Co-ordinator IQAC  
Vignan's Institute of Management & Technology for Women  
Kondapur (V), Ghatkesar (M), Medchal - Malkajgiri (D) - 501301  
Telangana State



*[Signature]*  
Principal  
Vignan's Institute of Management & Technology for Women  
Kondapur(V), Ghatkesar(M), Medchal-Malkajgiri(D)-501301  
Telangana State

# Participation in NIRF



## National Institutional Ranking Framework

Ministry of Education



### Welcome to Data Capturing System: ENGINEERING

Institute ID

Institute Name: Vignan's Institute of Management & Technology for Women

Full Report

#### Sanctioned (Approved) Intake

Academic Year	2020-21	2019-20	2018-19	2017-18	2016-17
UG [4 Years Program(s)]: Sanctioned (approved) students intake	420	420	300	300	---

#### Total Actual Student Strength (Program(s) Offered by Your Institution)

(All programs of all years)	No. of Male Students	No. of Female Students	Total Students	Within State (Including male & female)	Outside State (Including male & female)	Outside Country (Including male & female)	Economically Backward (Including male & female)	Socially Challenged (SC+ST+OBC Including male & female)	No. of students receiving full tuition fee reimbursement from the State and Central Government	No. of students receiving full tuition fee reimbursement from Institution Funds	No. of students receiving full tuition fee reimbursement from the Private Bodies
UG [4 Years Program(s)]	0	1023	1023	1023	0	0	581	442	36	5	9

#### Placement & Higher Studies

UG [4 Years Program(s)]: Placement & higher studies for previous 3 years

Academic Year	No. of first year students intake in the year	No. of first year students admitted in the year	Academic Year	No. of students admitted through Lateral entry	Academic Year	No. of students graduating in minimum stipulated time	No. of students placed	Median salary of placed graduates (Amount in Rs.)	No. of students placed	No. of students placed
(2015-16)	300	185	(2016-17)	0	(2018-19)	184	109	220000 (Two lakhs and twenty thousand only)	14	
(2016-17)	300	203	(2017-18)	0	(2019-20)	192	133	300000 (Three lakhs only)	11	
(2017-18)	300	220	(2018-19)	0	(2020-21)	231	11	325000 (Three lakhs and twenty five thousand only)	0	

#### Ph.D Student Details

*[Signature]*  
**PRINCIPAL**  
 Vignan's Institute of Management & Technology For Women  
 Kondapur (V), Ghalkesar (M), Medchal-Malkajiri (Dt)-501301  
 Telangana State





**National Institutional Ranking Framework**  
Ministry of Education  
Government of India

Welcome to Data Capturing System: ENGINEERING

Submitted Institute Data for NIRF'2021'

Institute Name: VIGNAN'S INSTITUTE OF MANAGEMENT AND TECHNOLOGY FOR WOMEN [IR-E-C-19622]

**Sanctioned (Approved) Intake**

Academic Year	2019-20	2018-19	2017-18	2016-17	2015-16	2014-15
JG [4 Years Program(s)]	420	300	300	-	-	-
PG [2 Year Program(s)]	54	-	-	-	-	-

**Total Actual Student Strength (Program(s) Offered by Your Institution)**

(All programs of all years)	No. of Male Students	No. of Female Students	Total Students	Within State (Including male & female)	Outside State (Including male & female)	Outside Country (Including male & female)	Economically Backward (Including male & female)	Socially Challenged (SC-ST+OBC Including male & female)	No. of students receiving full reimbursement from the State and Central Government	No. of students receiving full reimbursement from Institution Funds	No. of students receiving full tuition fee reimbursement from the Private Bodies	No. of students who are not receiving full tuition fee reimbursement
JG [4 Years Program(s)]	0	961	961	952	9	0	216	449	349	0	1	315
PG [2 Year Program(s)]	0	0	0	0	0	0	0	0	0	0	0	0

**Placement & Higher Studies**

**G [4 Years Program(s)]: Placement & higher studies for previous 3 years**

Academic Year	No. of first year students intake in the year	No. of first year students admitted in the year	Academic Year	No. of students admitted through Lateral entry	Academic Year	No. of students graduating in minimum stipulated time	No. of students placed	Median salary of graduates(Amount in Rs.)	No. of students selected for Higher Studies
2014-15	600	10	2015-16	0	2017-18	8	8	180000(One Lakh Eighty Thousand)	0
2015-16	300	185	2016-17	0	2018-19	124	106	330000(Three Lakh Thirty Thousand)	10
2016-17	300	203	2017-18	0	2019-20	144	127	350000(Three Lakh Fifty Thousand)	11

**G [2 Years Program(s)]: Placement & higher studies for previous 3 years**

Academic Year	No. of first year students intake in the year	No. of first year students admitted in the year	Academic Year	No. of students graduating in minimum stipulated time	No. of students placed	Median salary of graduates(Amount in Rs.)	No. of students selected for Higher Studies
2016-17	18	5	2017-18	0	0	0(Zero)	0
2017-18	18	2	2018-19	0	0	0(Zero)	0
2018-19	54	0	2019-20	0	0	0(Zero)	0



Quality audit  
recognized by state,  
national or  
international agencies  
(ISO Certification,  
NBA)

# राष्ट्रीय प्रत्यायन बोर्ड

चौथा तल, ईस्ट टावर, एन. बी. सी. सी. प्लेस, भीष्म पितामह मार्ग, प्रगति विहार, लोधी रोड, नई दिल्ली -110003  
**NATIONAL BOARD OF ACCREDITATION**  
4th Floor, East Tower, NBCC Place, Bhisham Pitamah Marg, Pragati Vihar, Lodhi Road, New Delhi 110003



File No. 11-306-2018-NBA

Date 26.08.2022

To,

The Principal  
Vignan's Institute of Management & Technology for Women,  
Kondapur (V), Ghatkesar (M), Medichal (D)  
Telangana- 501301

**Subject:** Further accreditation status on the basis of Compliance Report of the programs in Tier II offered by Vignan's Institute of Management & Technology for Women, Kondapur (V), Ghatkesar (M), Medichal (D) Telangana- 501301.

Sir,

This is regarding Compliance Report submitted by Vignan's Institute of Management & Technology for Women, Kondapur (V), Ghatkesar (M), Medichal (D) Telangana- 501301 for the UG Engineering programs which were accredited by NBA in Tier-II for academic years 2019-20 to 2021-22 whose validity of accreditation has expired on 30.06.2022.

2. An Expert Team conducted data verification of the programs on 05<sup>th</sup> June, 2022. The report submitted by the Expert Team was considered by the concerned Committees constituted for the purpose in NBA. The Competent Authority in NBA has approved the following accreditation status to the programs as given in the table below:

Sl. No	Name of the Program(s) (UG)	Basis of Evaluation	Accreditation Status	Period of validity	Remarks
(1)	(2)	(3)	(4)	(5)	(6)
1.	Computer Science & Engineering	Tier-II June, 2015 Document	Accredited	Academic Years 2022-2023 to 2024-2025 i.e. Up to 30-06-2025	Accreditation status granted is valid for the period indicated in Col.5 or till the program has the approval of the Competent Authority, whichever is earlier
2.	Electronics & Communication Engineering		Accredited		

3. It may be noted that only students who graduate during the validity period of accreditation, will be deemed to have graduated with an NBA accredited degree.

4. The programs have been granted accreditation for further 3 years. Vignan's Institute of Management & Technology for Women, Kondapur (V), Ghatkesar (M), Medichal (D) Telangana- 501301 should submit fresh online application under First Cycle SAR through e-NBA portal at least five months before the expiry of validity of accreditation mentioned above.

5. The accreditation status awarded to the programs as indicated in the above table does not imply that the accreditation has been granted to Vignan's Institute of Management & Technology for Women, Kondapur (V), Ghatkesar (M), Medichal (D) Telangana- 501301 as a whole. As such the Institution should nowhere along with its name including on its letter head etc. write that it is accredited by NBA because it is program accreditation and not Institution accreditation. If such an instance comes to NBA's notice, this will be viewed seriously. Complete name of the program(s) accredited, level of program(s) and the period of validity of accreditation, as well as the Academic Year from which the accreditation is effective should be mentioned unambiguously whenever and wherever it is required to indicate the status of accreditation by NBA.

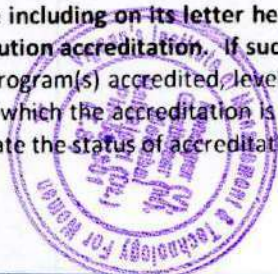

*Principal*  
Vignan's Institute of Management & Technology for Women,  
Kondapur (V), Ghatkesar (M), Medichal (D) Telangana- 501301

*Chandika*

6. The accreditation status of the above programs is subject to change on periodic review, if needed by the NBA. It is desired that the relevant information in respect of accredited programs as indicated in the table in paragraph 2, appears on the website and information bulletin of the Institute.

7. The accreditation status awarded to the programs as indicated in table in paragraph 2 above is subject to maintenance of the current standards during the period of accreditation. If there are any changes in the status (major changes of faculty strength, organizational structure etc.), the same are required to be communicated to the NBA, with an appropriate explanatory note.

8. A copy each of Report of the Visiting Team in respect of the above programs is enclosed.

Yours faithfully,

  
(Dr. Anil Kumar Nassa)  
Member Secretary

Encls: 1. Copy each of Report of the Visiting Team in respect of the programs.

**Copy to:**

1. The Registrar,  
Jawaharlal Nehru Technological University, Hyderabad,  
F9VR+8H2, Ashok Nagar, Kukatpally Housing Board Colony,  
Kukatpally, Hyderabad, Telangana 500085
2. The Commissioner,  
Directorate of Technical Education  
2nd Floor, Vidya Bhavan,  
Opp. to Latha Talkies, Nampally,  
Hyderabad - 500 001
3. Accreditation File
4. Master Accreditation file of the State



  
PRINCIPAL  
Vignans Institute of Management & Technology For Women  
Kondapur (Ch), Ghatkesar (H), Malkajgiri (Dist), Pin-500 085  
Telangana State

# NATIONAL BOARD OF ACCREDITATION

NBCC Place, East Tower, 4<sup>th</sup> Floor, Bhisham Pitamah Marg,  
Pragati Vihar, New Delhi-110 003  
Tel: +91 11 2436 0620-22, 2436 0654 ; Telefax: +91 11 4308 4903  
Website: www.nbaind.org



F. No. 11-306-2018-NBA

Dated: 19-03-2019

To  
The Principal  
Vignan's Institute of Management & Technology for Women,  
Kondapur (V), Ghatkesar (M), Medichal (D)  
Telangana- 501301

Subject: Accreditation status of programmes applied by Vignan's Institute of Management & Technology for Women, Kondapur (V), Ghatkesar (M), Medichal (D) Telangana- 501301.

Sir/Madam,

This has reference to your application I.D. No. 3125-04/09/2018 seeking accreditation by National Board of Accreditation in Tier-II format to UG Engineering programs offered by Vignan's Institute of Management & Technology for Women, Kondapur (V), Ghatkesar (M), Medichal (D) Telangana-501301.

2. An Expert Team conducted on-site evaluation of the programs from 04<sup>th</sup>- 06<sup>th</sup> January, 2019. The report submitted by the Expert Team was considered by the concerned Committees constituted for the purpose in NBA. The competent authority in NBA has approved the following accreditation status to the programs as given in the table below:

Sl. No	Name of the Program (UG)	Basis of Evaluation	Accreditation Status	Period of validity	Remarks
(1)	(2)	(3)	(4)	(5)	(6)
1.	Computer Science & Engineering	Tier-II June 2015 Document	Accredited	Academic Years 2019-2020 to 2021-2022 i.e. Up to 30-06-2022	Accreditation status granted is valid for the period indicated in Col.5 or till the program has the approval of the competent authority, whichever is earlier
2.	Electronics & Communication Engineering		Accredited		

3. It may be noted that only students who graduate during the validity period of accreditation, will be deemed to have graduated with an NBA accredited degree.

4. The programs have been granted accreditation for 3 years. Vignan's Institute of Management & Technology for Women, Kondapur (V), Ghatkesar (M), Medichal (D) Telangana- 501301 should submit the Compliance Report at least six months before the expiry of validity of accreditation mentioned above to be eligible for consideration by the concerned Committee in NBA for further processing of the accreditation status. This could entail further extension of accreditation or a revisit, as deemed appropriate by NBA Committees.

5. The accreditation status awarded to the programs as indicated in the above table does not imply that the accreditation has been granted to Vignan's Institute of Management & Technology for Women, Kondapur (V), Ghatkesar (M), Medichal (D) Telangana- 501301 as a whole. As such the Institution should nowhere along with its name including on its letter head etc. write that it is accredited by NBA because it is program accreditation and not Institution accreditation. If such an instance comes to NBA's notice, this will be viewed seriously. Complete name of the program(s) accredited, level of program(s) and the period of validity of accreditation, as well as the Academic Year from which the accreditation is effective should be mentioned unambiguously whenever and wherever it is required to indicate the status of accreditation by NBA.

  
PRINCIPAL

Vignan's Institute of Management & Technology For Women  
Kondapur (V), Ghatkesar (M), Medchal-Malkajgiri (Dt)-501301  
Telangana State



6. The accreditation status of the above programs is subject to change on periodic review, if needed by the NBA. It is desired that the relevant information in respect of accredited programs as indicated in the table in paragraph 2, appears on the website and information bulletin of the Institute.
7. The accreditation status awarded to the programs as indicated in table in paragraph 2 above is subject to maintenance of the current standards during the period of accreditation. If there are any changes in the status (major changes of faculty strength, organizational structure etc.), the same are required to be communicated to the NBA, with an appropriate explanatory note.
8. A copy each of the Report of Chairman of the Visiting Team and Evaluators' Reports in respect of the above programs are enclosed.
9. If the Institute is not satisfied with the decision of NBA, it may appeal within thirty days of receipt of this communication giving reasons for the same and by paying the requisite fee.

Yours faithfully,

  
(Dr. Anil Kumar Nassa)  
Member Secretary

- Encls: 1. Copy of Report of Chairman of the Visiting Team.  
2. Copy each of Expert Reports of the Visiting Team.

Copy to:

1. The Registrar,  
Jawaharlal Technological University, Hyderabad  
Kukatpally, Hyderabad-500085, Telangana
2. The Commissioner,  
Directorate of Technical Education  
5<sup>th</sup> and 6<sup>th</sup> Floors, B.R.K.R. Bhavan,  
Tankbund Road, Saifabad, Hyderabad-500063
4. Accreditation File
5. Master Accreditation folder of the State



  
PRINCIPAL  
Vignans Institute of Management & Technology For Women  
Kondapur (V), Ghatkesar (M), Medchal-Malkajgiri (Dt)-501301  
Telangana State

CERTIFICAT ♦ CERTIFICADO ♦ СЕРТИФИКАТ ♦ CERTIFICATE ♦



# CERTIFICATE



This is to Certify that the Management System of

## VIGNAN'S INSTITUTE OF MANAGEMENT AND TECHNOLOGY FOR WOMEN

KONDAPUR (V), GHATKESAR (M), HYDERABAD,  
MEDCHAL (DIST), PIN - 501 301, TELANGANA, INDIA

.has been found to conform to the Energy Management System standard:

### ISO 50001:2018

This certificate is valid for the following scope of operations:

Providing Technical Educational Services Leading to award of Under Graduate Programs in Engineering (B.Tech) and Post Graduate Programs in Engineering (M.Tech).

Certificate No.: IN54933G

Date of initial registration	Date of this Certificate	Surv. audit on or before / Certificate expiry	Recertification Due
12 May 2023	12 May 2023	11 May 2024	11 May 2026



This Certificate remains valid subject to satisfactory surveillance audits.

*Paul*  
Director



This Certificate is the property of Staunchly Management & System Services Limited and shall be returned immediately when demanded.

**STAUNCHLY MANAGEMENT AND SYSTEM SERVICES LIMITED**

Labrynth Business Centre,43 Middle Hill Gate,  
Stockport Great Manchester,England-SK1 3DG  
Web : [www.staunchlyservices.com](http://www.staunchlyservices.com)  
E-mail : [info@staunchlyservices.com](mailto:info@staunchlyservices.com)  
Phone : +44 7404621007  
Company Registered in England with

**PRINCIPAL**  
Vignans Institute of Management & Technology For Women  
Kondapur(V), Ghatkesar(M), Medchal-Malkajgiri(Dt)-501301  
Telangana State





**KVQA**

# Certificate of Registration

(Environment Management System)

**KVQA CERTIFICATION SERVICES PVT. LTD.**

This is to certify that the Environment Management System of



## **VIGNAN'S INSTITUTE OF MANAGEMENT AND TECHNOLOGY FOR WOMEN**

**KONDAPUR (V), GHATKESAR (M), HYDERABAD,  
MEDCHAL (DIST), PIN - 501 301, TELANGANA, INDIA**

Has been found in accordance with Environmental Management  
System standard

**ISO 14001:2015**

This certificate is valid for the following product or service range

**Providing Technical Educational Services Leading to award of Under  
Graduate Programs in Engineering (B.Tech) and Post Graduate  
Programs in Engineering (M.Tech).**

1<sup>st</sup> Surveillance Due On: 10/03/2024: Done On:

2<sup>nd</sup> Surveillance Due On: 10/03/2025: Done On:

**Certificate No: KDAACE20230402**

Date Of Issue: 10, April, 2023

Valid Until: 09, April, 2026\*

Issued by

Authorized signatory KVQA



To Check the Status of the Certification kindly log on to [www.kvqa.in](http://www.kvqa.in)  
F-300, Sector - 63, Noida U.P. India. Ph- 011 -22711940, 22711941  
Email : [delhi@kvqaindia.com](mailto:delhi@kvqaindia.com)

\*Subject to successful completion of surveillance audits

Emirates International Accreditation Centre  
CB-EMS-045





Where there is Rural Wellbeing  
there is Universal Prosperity



सत्यमेव जयते  
Ministry of Education  
Government of India

भारत सरकार/ Government of India  
महात्मा गांधी राष्ट्रीय ग्रामीण शिक्षा परिषद / Mahatma Gandhi National Council of Rural Education  
उच्चशिक्षाविभाग/Department of Higher Education  
शिक्षामंत्रालय / Ministry of Education

# Certificate of Accreditation

This is to certify that

**Vignan's Institute of Management and Technology for Women**

**Medchal Malkajigiri Telangana State**

is graded as

Parameters	Green Cover on campus	Surface Water Harvesting	Rooftop Water Harvesting	Rooftop Solar System	Waste Management
Grades	A+	A+	A	A	A

for the academic year of 2022-23 in Phase 1 of the  
**National Rural Institutions Sustainability Grading (NRISG)**

*24/3*  
PRINCIPAL  
Vignan's Institute of Management & Technology For Women  
Kondapur (V), Chaitkesar (M), Medchal-Malkajigiri (Dt.)-501301  
Telangana State

*Nagalakshmi.*

Member Secretary



Date: March 2023

Certificate No: MGNCRE/NRISG/N/005

**Audit Report – AY: 2022-23**

**ACKNOWLEDGEMENT**

We are grateful to the management and committee members of Vignan's Institute of Management and Technology for Women, Ghatkesar, Hyderabad, to award this prestigious project on Environmental auditing. Further we sincerely thank the college staff for providing us with the necessary facilities and cooperation during the audit. This ample cooperation helped us a lot in making this audit possible and successful.

For KVQA CERTIFICATION SERVICES PVT.LTD

(Lav Kaushik)  
Lead Auditor

KVQA CERTIFICATION SERVICES PVT. LTD.

Authorized Signatory



  
PRINCIPAL

Vignan's Institute of Management & Technology For Women  
Kondapur (V), Ghatkesar (M), Medchal-Malkajgiri (Dt)-501301  
Telangana State

## On-site audit report

Organization	VIGNAN'S INSTITUTE OF MANAGEMENT AND TECHNOLOGY FOR WOMEN	MR	D Venugopal Rao	Audit No.	2023/E-05/151
Address	KONDAPUR (V), GHATKESAR (M), HYDERABAD, MEDCHAL (DIST), PIN - 501 301, TELANGANA, INDIA				
Audit type	<input checked="" type="checkbox"/> Initial (Reassessment), On-site. <input type="checkbox"/> Re-audit. <input type="checkbox"/> surveillance <input type="checkbox"/> Change. <input type="checkbox"/> Special surveillance. <input type="checkbox"/> Others ( )				
Certification scope	Providing Technical Educational Services Leading to award of Under Graduate Programs in Engineering (B.Tech) and Post Graduate Programs in Engineering (M.Tech).				
IAF CODE	37				
Standard	<input type="checkbox"/> ISO (9001:2015) . <input type="checkbox"/> ISO 22000 . <input checked="" type="checkbox"/> ISO14001:2015. <input type="checkbox"/> OH&S 45001:2018				
Audit day	03/04/2023 (M D)				
Audit team	Lead auditors'	Auditors	Audit trainee		
	(sign) Lav Kaushik	(sign )	(sign)		
Next audit	Follow-up or Re-audit	<input type="checkbox"/> Document. On-site( ) <input type="checkbox"/> Re-audit ( )			
	Surveillance or reassessment	Date: Audit type: ( Surv ) audit			
Result of follow-up audit	Summary ( <input type="checkbox"/> Onsite confirm, <input type="checkbox"/> Document confirm) The client has implement/Not implemented the CAR Date: Auditor: (signature)				

## Attachment

<input type="checkbox"/> Audit summary (KAF-09) <input type="checkbox"/> Attendance sheet (KAF-10) <input type="checkbox"/> Audit schedule Stage 1 (KAF-13) <input type="checkbox"/> Audit schedule Stage 2 (KAF-12) <input type="checkbox"/> Confirmation of certification scope (KAF-14) <input type="checkbox"/> Details for certificate of multi-sites (KAF-21)(if applicable) <input type="checkbox"/> Surveillance program (KAF-17)	<input type="checkbox"/> CAR register (KAF-18) <input type="checkbox"/> Corrective action request (CAR)(KAF-19) <input type="checkbox"/> Observation reports (KAF-20) <input type="checkbox"/> Report of document review (A&B)KAF-07 <input type="checkbox"/> Audit checklist Others ( ) ※Below forms shall be distributed to applicants as well
---	--

※ indicates attachments for initial(Reassessment) audit or any changes occurred  
 ★ limited to KVQA CERTIFICATION SERVICES PVT.LTD. Audit File.

Recipient: Registration Applicant organization, KVQA CERTIFICATION SERVICES PVT.LTD., other ( )

※ All the records recorded during audit shall be confidential and shall not disclose to any person or entity without consent of an applicant, except upon request from Accreditation body for its evaluation of KVQA CERTIFICATION SERVICES PVT LTD. Certification procedures  
 The audit has been done on sampling basis

※ Guidance of certification procedures applies

Address KVQA CERTIFICATION SERVICES PVT.LTD.



KVQA CERTIFICATION SERVICES PVT. LTD.

Authorised Signatory

*Adh*  
 PRINCIPAL

Vignan's Institute of Management & Technology For Women  
 Kondapur (V), Ghatkesar (M), Medchal-Malkajgiri (Dt)-501301  
 Telangana State

**Audit schedule for ISO 14001:2015**

Organization	VIGNAN'S INSTITUTE OF MANAGEMENT AND TECHNOLOGY FOR WOMEN	Audit no.	2023 E-05/151	Revision	0
Address	KONDAPUR (V), GHATKESAR (M), HYDERABAD, MEDCHAL (DIST), PIN - 501 301, TELANGANA, INDIA				
Scope	Providing Technical Educational Services Leading to award of Under Graduate Programs in Engineering (B.Tech) and Post Graduate Programs in Engineering (M.Tech).				
Date	Time	Auditing Elements (departments) Per Each Auditor			ISO 14001:2015 Clauses
		LEAD AUDITOR Lav Kaushik	Auditor Mr.	EXPERT) Mr.	
03/04/2023	10:00 to 10:30	Opening Meeting			
	10:30 to 11:30	EMR Internal audit and Management review			
	11:30 to 12:00	Legal & Evaluation of Compliance			
	12:00 to 1:00	Training and HR			
	1:00 to 2:00	Lunch			
	2:00 to 3:00	Aspect and Impact EMS Risk			
	3:00 to 4:00	EMP & Operational Control			
	4:00 to 5:00	Emergency preparedness			
	5:00 to 5:30	Top management			
	5:30 to 6:30	Closing Meeting			
Date: 03/04/2023		Lead Auditor: Lav Kaushik(Signature)			

Audit Objective: - The Audit shall be carried on the basis of the requirement of the Standard, Evaluation of the ability of the Organization to meet applicable Statutory/Regulatory/Contractual requirements, meeting Objectives and Identification of potential improvement of Management System. The answers to be reported under the respective clauses in the Audit summary.



  
**PRINCIPAL**  
 Vignans Institute of Management & Technology For Women  
 Kondapur (V), Ghatkesar (M), Medchal-Malkajgiri (Dt)-501301  
 Telangana State



Organization	VIGNAN'S INSTITUTE OF MANAGEMENT AND TECHNOLOGY FOR WOMEN	Audit no.	2023/E-05/151	Issue date	03/04/2023
Applicable Standards	<input type="checkbox"/> ISO 9001 ISO 9001:2015 <input checked="" type="checkbox"/> ISO 14001 ISO 14001:2015 <input type="checkbox"/> ISO 45001 ISO 45001:2018	Applicable Clause	6.1.4		
		Division	Maintenance		
		Auditor	(signature)		
Audit type	<input checked="" type="checkbox"/> Initial. 2nd surveillance <input type="checkbox"/> Others ( )	Non-conformity Grade	<input checked="" type="checkbox"/> Minor nonconformity <input type="checkbox"/> Major nonconformity		
Nonconformity ( Confirm with on-site visit <input checked="" type="checkbox"/> Confirm with document)					
There is no Operational control procedure for discard of e waste related to computer or printer					
Lead Auditor:	Lav Kaushik(sign)	E. Management Representative: (sign)			
Analysis (Basic reason for occurring nonconformity Procedure is not formulated for the the e waste management.					
Corrective action ( Plan. Result (Attachment Yes No)E waste management procedure will be submitted.					
E. Management Representative: EMR. (sign)				Date:03/04/2023	
Follow-up audit	( document confirm on-site confirm) (sign)	Validation Auditor:Date:	(sign)		
Auditor:Date:					

- The result of corrective action taken shall be submitted to KVQA CERTIFICATION SERVICES within 1 month after CAR issued.
- The result of corrective action taken shall be verified by on-site audit (major nonconformity) or document review (minor nonconformity), if it is not made within 3 months re-audit will be required.

KVQA CERTIFICATION SERVICES PVT. LTD.

*(Signature)*  
 Authorised Signatory



*(Signature)*  
 PRINCIPAL  
 Vignan's Institute of Management & Technology For Women  
 Kondapur (V), Ghatkesar (M), Medchal-Malkajiri (Dt)-501301  
 Telangana State

### Observation reports

Organization: VIGNAN'S INSTITUTE OF MANAGEMENT AND TECHNOLOGY FOR WOMEN

Audit no 2023/E-05/151 Page:1/1

Department	Contents Points for Improvement	ISO Element	Grade of NC
			Observation
	Review of the transport condition is not done		observation
	Communication of EMS policy among the staff is not done.		observation
	Tracker for the completion of EMS objective is not evidenced.		observation
	Few legal records are not updated in the legal register.		observation
	Mock drill records are evidenced but the photographs are not evidence.		observation
	Emergency evacuation plan is not updated.		observation

Auditor: Lav Kaushik (signature)

Audit date: 03/04/2023

KVQA CERTIFICATION SERVICES PVT. LTD.

Authorized Signatory



PRINCIPAL

Vignans Institute of Management & Technology For Women  
Kondapur (V), Ghatkesar (M), Medchal-Malkajgiri (Dt)-501301,  
Telangana State

**Audit summary**

Organization	VIGNAN'S INSTITUTE OF MANAGEMENT AND TECHNOLOGY FOR WOMEN	Date	03/04/2023	Audit No.	2023/E-05/151
CAR issue	<input checked="" type="checkbox"/> Minor 01 issue, Major 0 issue (Onsite confirm required) <input checked="" type="checkbox"/> Document confirm				
Document	Manual No. 0 Rev. No. 00				
Evaluation	Does organization's system comply with certification audit criteria?				<input checked="" type="checkbox"/> Yes, <input type="checkbox"/> No
	Was there any deviation from audit plan? If Yes Please Specify				<input type="checkbox"/> Yes, <input checked="" type="checkbox"/> No
	Are proper corrective & preventive actions taken according to the results of internal audit?				<input checked="" type="checkbox"/> Yes, <input type="checkbox"/> No
	Was there any issue impacting the audit program? If Yes please specify				<input type="checkbox"/> Yes, <input checked="" type="checkbox"/> No
	Is there any significant changes that can affect management system since last audit & any difference between data submitted by organization and assessed in on-site audit?				<input type="checkbox"/> Yes, <input checked="" type="checkbox"/> No
	Is it assured that organization maintain and develop its system continuously?				<input type="checkbox"/> Yes, <input checked="" type="checkbox"/> No
	(Additional review points in reassessment)				
	Does all elements of system effectively interact with one another?				<input checked="" type="checkbox"/> Yes, <input type="checkbox"/> No
	Is there any unresolved issue identified? If Yes Please specify				<input type="checkbox"/> Yes, <input checked="" type="checkbox"/> No
	Is it assured that organization has commitment for maintaining its system effectively?				<input checked="" type="checkbox"/> Yes, <input type="checkbox"/> No
(Additional review point in surveillance)					
Is the certification mark properly used?				<input type="checkbox"/> Yes, <input type="checkbox"/> No	
(Effectiveness of the system, Requirements for improvement) The organization has well implemented environmental management system The organization has all the necessary documents regarding the Manufacturing and Supply of Refractories. Aspect impact analysis of EMS along with the environment risks have been Identified with control measures in HSE plan. Appropriate EMS implementation On-site at temporary site was also found proper. Training need identification to be Made and training should start from Top management to the workers. All major suppliers Are environment concerned and ISO certified? All employees are aware of emergency Conditions. Mock Drill Training Records were evident. Customer feedback form to be Introduced and benefit to society plan not available. The Observation Report is annexed For ready reference. The auditors are convinced that after implementation of the Observation, the company will have a better environmental management system. One minor CAR issued in operational control and observation compliance for corrective action shall be verified in the next audit. Hence the company is recommended for Continue of certificate					
Audit Result	<input checked="" type="checkbox"/> Recommend certification for initial audit, maintain its certification for surveillance. As your system is proper and effectively practiced, certification is recommended <input type="checkbox"/> After document audit as follow-up, it will be resolved Your system is practiced without any serious major non-conformity as shown from CAR issue. You are required to submit the result of corrective action taken, which includes corrective action, analysis of the reason, and preventive action to KVQA CERTIFICATION SERVICES within 1month. When the result is satisfactory, certification will be recommended (certification will be maintained for surveillance). The observations shall be verified in the Surveillance audit <input type="checkbox"/> After on-site visit as follow-up, this will be resolved More than 01 Minor non-conformity is found in your system as shown from above CAR issues. You are required to submit the result of corrective action taken, which includes corrective action, analysis of the reason, and preventive action to KVQA CERTIFICATION SERVICES within 1month. Additional on-site visit as follow-up will be conducted and when it is satisfactory, certification will be recommended (maintained for surveillance). <input type="checkbox"/> Not to satisfy with standard Major non-conformities are found in your system as shown from above CAR issues. Re-audit is required				
	<input type="checkbox"/> Not to certify with standard Major non-conformities are found in your system as shown from above CAR issues. Re-audit is required				
Audit fee	Remitted or not?	<input type="checkbox"/> Yes <input type="checkbox"/> No (When audit fee is paid, certification will not be issued/maintained)			



KVQA CERTIFICATION SERVICES PVT. LTD.

Authorised Signatory

*Signature*

PRINCIPAL

Vignans Institute of Management & Technology For Women  
 Kondapur (V), Ghatkesar (M), Medchal-Malkajgiri (Dt)-501301  
 Telangana State





**KVQA**

# Certificate of Registration

(Environment Management System)

**KVQA CERTIFICATION SERVICES PVT. LTD.**

This is to certify that the Environment Management System of



## **VIGNAN'S INSTITUTE OF MANAGEMENT AND TECHNOLOGY FOR WOMEN**

**KONDAPUR (V), GHATKESAR (M), HYDERABAD,  
MEDCHAL (DIST), PIN - 501 301, TELANGANA, INDIA**

Has been found in accordance with Environmental Management  
System standard

**ISO 14001:2015**

This certificate is valid for the following product or service range

**Providing Technical Educational Services Leading to award of Under  
Graduate Programs in Engineering (B.Tech) and Post Graduate  
Programs in Engineering (M.Tech).**

1<sup>st</sup> Surveillance Due On: 10/03/2024; Done On:  
2<sup>nd</sup> Surveillance Due On: 10/03/2025; Done On:

Certificate No: **KDACE20230402**

Date Of Issue: 10, April, 2023  
Valid Until: 09, April, 2026\*

Issued by

Authorised signatory KVQA



**eiaci**

To Check the Status of the Certification kindly log on to [www.kvqa.in](http://www.kvqa.in)  
E-300, Sector - 63, Noida U.P. India. Ph- 011 -22711940, 22711941  
Email : [delhi@kvqaindia.com](mailto:delhi@kvqaindia.com)

\*Subject to successful completion of surveillance audits



*Adh*  
PRINCIPAL

Vignans Institute of Management & Technology For Women  
Kondapur (V), Ghatkesar (M), Medchal-Malkajgiri (Dt)-501301  
Telangana State

# STAUNCHLY MANAGEMENT AND SYSTEM SERVICES LIMITED



## ISO 50001; 2018 INITIAL REPORT

**COMPANY NAME:** VIGNAN'S INSTITUTE OF MANAGEMENT AND TECHNOLOGY FOR WOMEN

**COMPANY ADDRESS:** KONDAPUR (V), GHATKESAR (M), HYDERABAD, MEDCHAL (DIST), PIN - 501 301, TELANGANA, INDIA

**Company Representative:**

**Start date of visit:** 03<sup>rd</sup> & 04<sup>th</sup> May 202023  
**Visit duration:** 02 Days

**AUDIT TEAM – Lead Auditor**

ARUN KUMAR

STAUNCHLY MANAGEMENT AND SYSTEM  
SERVICES LIMITED

Authorised Signatory

Page 1 of 7

  
Vignans Institute of Management & Technology For Women  
Kondapur (V), Ghatkesar (M), Medchal-Mulkajgi (Dist)-501301  
Telangana State



## AUDIT SCOPE & OBJECTIVES

### Objectives

To evaluate the ongoing effective compliance of the Energy Management System against the requirements of ISO 50001:2018, the scope of certification and your own Energy Management System(EnMS).

The audit will also identify any areas of potential improvement to your management system, as appropriate to the audit scope.

### Scope

Providing Technical Educational Services Leading to award of Under Graduate Programs in Engineering (B.Tech) and Post Graduate Programs in Engineering (M.Tech).

This scope was reviewed during this audit and was considered appropriate, there are no foreseen changes at this time.

### Standard – Audit Criteria

ISO 50001; 2018

### Site location

**KONDAPUR (V), GHATKESAR (M), HYDERABAD,  
MEDCHAL (DIST), PIN - 501 301, TELANGANA, INDIA**

STAUNCHLY MANAGEMENT AND SYSTEM  
SERVICES LIMITED

  
Authorised Signatory

  
Vignar's Institute of Management & Technology For Women  
Kondapur (V), Ghatkesar (M), Medchal, Angul (Dist) Sec-01  
Telangana State



**AUDIT FINDINGS**

**Nonconformities identified during last visit – (VMTW05015)**

There were no corrective actions required to be taken in response to the last audit.

There are no outstanding nonconformities from previous audits.

**Nonconformities identified during this visit – Aspect Impact register is not updated**

The assessment was based on sampling.

**ASSESSMENT COMMENTS & OPPORTUNITIES FOR IMPROVEMENT**

**ASSESSMENT COMMENTS**

From the sample selected for audit at this surveillance audit the VIGNAN'S INSTITUTE OF MANAGEMENT AND TECHNOLOGY FOR WOMEN management & employees have demonstrated that they are maintaining their Energy Management System (EnMS) in line with Energy management processes and the policy objectives. As can be seen form the findings of this report there is evidence of compliance with both ISO 50001:2018 and the EnMS, Policy and Objectives. The EnMS was seen to have the capability to meet applicable requirements and expected outcomes.

EnPI's are identified and energy objectives have been set as part of the energy review process. From the representative sample taken as part of the audit the EnMS was seen to be capable of achieving Energy policy commitments, objectives and operational control needs. The EnMS was assessed and found to be managing internal monitoring processes & internal audits.

The assessment demonstrated a high level of implementation of the processes and monitoring and measurement activities, ensuring that the planned arrangements are achieved. Management review and internal audits continue to be carried out to a high standard, are effective and conform to the requirements of the standard

Monthly monitoring of energy is reviewed and the results are investigated as appropriate. There is an opportunity to improve the investigation reporting (OFI/02) Energy performance is known and performance is evaluated against the objectives and predicted energy use.

There have been significant improvement made to the detail and effectiveness of the individual site audits. The duration and detail of the audit has been increased, and there is a positive effect can be seen in the energy performance. The audits now include interrogating the BMS and other control systems on site, improving control of energy use and better reflecting the sites occupancy.

STANCHLY MANAGEMENT AND SYSTEM  
SERVICES LIMITED

Authorised Signatory

  
PRINCIPAL

Vignans Institute of Management & Technology For Women  
Kondapur (V), Ghatkesar (M), Medchal (M) Hyderabad (T.S.)  
Telangana 501002



**Site Review**

The audit was completed on site. A tour of 1 locations was included in this initial audit . These sites were all academic locations.

The site tours included interviews with the facilities managers and Facility Assistants, a review of site energy monitoring and a tour of the buildings including academics areas as relevant.

All of the locations visited were seen to be managed in line with the energy management system with onsite teams demonstrating a good understanding of the significant energy uses and the variables that effect energy efficiency.

**AUDIT CONCLUSION**

**Summary and certification status**

During the assessment no nonconformities were raised.

Continued certification is recommended.

The audit plan & objectives have been achieved and the certificate scope remains appropriate.

ISO 50001: During this audit it has been demonstrated and confirmed that there has been continual energy performance improvement made across the business. Examples of which are detailed in this report.

**Follow up action required**

In response to any nonconformity raised you are required to prepare, document and implement a correction and corrective action plan. Each finding must be investigated to identify any root causes or underlying trends. Appropriate action must be taken to eliminate the cause of any nonconformity in order to prevent reoccurrence. The plan must define timely action, timescales and responsibilities.

There is no need to submit this plan to us as the actions detailed will be verified by the auditor during the next visit.

Failure to adequately implement the planned action may result in the raising of a major nonconformity putting your certification in jeopardy.

A response to any opportunity for improvement raised is optional.

STAINCHLY MANAGEMENT AND SYSTEM SERVICES LIMITED

  
Authorised Signatory

  
PRINCIPAL

Vignar's Institute of Management & Technology For Women  
Kondapur V, Ghatkesar Rd, Medchal-Mahabubnagar District  
Telangana-501416



The scope of the EnMS has been updated to include carbon emissions from scope 3 sources. This has been done in anticipation of changes to the legal compliance scheme 'PAT Perform Achieve and Trade'. This may include net zero in future. This has been seen as an opportunity to remain compliant with PAT via the ISO 50001:2018 Certification. The details are to be fully established following the issue of government guidance on the changes to the PAT scheme.

There are potential complications with the relationship between Carbon reduction and energy efficiency. This will be monitored at future audits and will become clearer how this will fit in to the ISO 50001 EnMS, once the Indian Government has published the new PAT guidance / Scheme documents.

Continual Improvement of energy performance and the EnMS was demonstrated during this audit and the 3 year cycle. There are processes in place to identify and manage continual improvement. There has been significant improvement in energy performance set against the baseline. PIOEATFW continues to make cycle significant investment in new buildings to replace the older stock. There is an established commitment to continual improvement with stretching future objectives in place

All of the employees and management interviewed during this assessment were positive and demonstrated an awareness of the EnMS. There was an open dialogue established which greatly assisted the auditor – Thank You.

#### OPPORTUNITIES FOR IMPROVEMENT

##### OFI/01 – LEADERSHIP:

Top Management - Energy Policy and Carbon Management Plan were drafted by the Associate Director (Sustainable Operations) and approved by the Director of Estates.

The Carbon & Environment Action Group (C&EAG), is no longer responsible for this. The leadership section of the Compliance manual, needs to be reviewed to reflect this recent change in authorities.

##### OFI/02 – INVESTIGATION OF SIGNIFICANT DEVIATIONS:

Significant deviations are identified as part of the monthly energy monitoring process, with sites identified as having significant deviations required to investigate and respond the energy team.

A number of the responses are limited in detail and slow. Significant deviation needs to be investigated and responded to, to ensure energy performance is maintained. There is an opportunity to improve the response detail and time.  
ISO 50001:2018 9.1.1

Thanks to the company and its people for their time and cooperation during the audit.

STAUNCHLY MANAGEMENT AND SYSTEM  
SERVICES LIMITED

Authorised Signatory



Vignee Institute of Management & Technology  
Kozhikode (V), Coimbatore (M), Mysore (K), Bangalore (B),  
Tirunelveli (T)



**MISCELLANEOUS**

**Changes to your management system**

You must not carry out significant changes to the Energy Management System, without first confirming with your auditor that the proposed changes are acceptable.

**Report distribution**

The report will be distributed to the company representative, the Lead Auditor and the Business Support Team (for archiving), unless otherwise agreed.

**Report confidentiality**

This report will not be disclosed to any third party by us. You are free to circulate it as required, however, if this report is circulated to a third party the entire content (excluding audit trail) must be included.

**NEXT VISIT**

The current 3 year audit programme, audit frequency and duration, were considered during this visit against your current scope and manning levels. The audit program and auditor competences are confirmed as suitable and sufficient and remain unchanged.

The next visit will be due in May 2026 and will be of 2 days duration.

An Audit programme including an agreed outlined plan for your next assessment visit and a summary of previous assessments in the certification cycle is attached to/included in this report. Further details as appropriate will be confirmed prior to your next assessment visit.

STANCHLY MANAGEMENT AND SYSTEM SERVICES LIMITED

  
Authorised Signatory



Vopari's Institute of Management & Technology Pvt. Ltd.  
Kondhwa, Chhatrapati Shivaji Maharaj (S. J.) Road,  
Pune-411 004



**Next visit plan – 2 day EnMS Initial Audit.**

Date	Time	Auditor	Area / Department / Process / Function
KONDAPUR (V), GHATKESAR (M), HYDERABAD, MEDCHAL (DIST), PIN - 501 301, TELANGANA, INDIA			
Jan2017	9:00	Arun kumar	Arrive On Site - On site meeting and greeting
	09.15		<b>Opening Meeting &amp; Management System Administration</b> Management System Manual / Policy / Risks and Opportunities / Management Review / Objectives & targets. <b>Internal Audits</b> Including corrective action management. Evaluation of Legal compliance <b>Management Review</b> <b>Energy Planning, Baseline &amp; Performance</b> <b>Lunch</b> <b>Operational Control - Site Tour</b> Including site tours – Energy use, monitoring, communication, maintenance energy projects. <b>Auditor / Report Preparation Time - The close out &amp; follow up on any outstanding details picked up during the audit</b>
	12.45		
	16.30	Arun kumar	End of day review
Day 2 Jan 2017	9:00	Arun kumar	Arrive on site
	09.15		<b>Monitoring &amp; Measurement</b> Including significant deviations. <b>Operational Control – Site Tour</b> Including site tours – Energy use, monitoring, communication, maintenance energy projects. <b>Lunch</b> <b>Competence, Training &amp; Awareness</b> Identification of personnel who can have a significant effect on energy use. Evidence of training and awareness on site. <b>Auditor / Report Preparation Time - The close out &amp; follow up on any outstanding details picked up during the audit</b>
	16.00		Closing Meeting

**Notes to Client:**

- Times are approximate and will be confirmed at the opening meeting prior to commencement of the audit.
- Our auditors reserve the right to change or add to the elements listed before or during the audit depending on the results of on-site investigation
- Your contract with us is an integral part of this audit plan and details confidentiality arrangements, audit scope, information on follow up activities and any special reporting requirements.

**End of Report**

**STANCHLY MANAGEMENT AND SYSTEM SERVICES LIMITED**

*[Handwritten Signature]*  
 CHIEF PA

*[Handwritten Signature]*  
 Authorised Signatory





◆ CERTIFICAT ◆ CERTIFICADO ◆ СЕРТИФИКАТ ◆ CERTIFICATE ◆ ZERTIFIKAT



# CERTIFICATE



This is to Certify that the Management System of

## VIGNAN'S INSTITUTE OF MANAGEMENT AND TECHNOLOGY FOR WOMEN

KONDAPUR (V), GHATKESAR (M), HYDERABAD,  
MEDCHAL (DIST), PIN - 501 301, TELANGANA, INDIA

.has been found to conform to the Energy Management System standard:

### ISO 50001:2018

This certificate is valid for the following scope of operations:

**Providing Technical Educational Services Leading to award of Under Graduate Programs in Engineering (B.Tech) and Post Graduate Programs in Engineering (M.Tech).**

*Certificate No.: IN54933G*

<u>Date of initial registration</u>	<u>Date of this Certificate</u>	<u>Surv. audit on or before / Certificate expiry</u>	<u>Recertification Due</u>
12 May 2023	12 May 2023	11 May 2024	11 May 2026



This Certificate remains valid subject to satisfactory surveillance audits.

*Paul*  
\_\_\_\_\_  
Director



This Certificate is the property of Staunchly Management & System Services Limited and shall be returned immediately when demanded.

**STAUNCHLY MANAGEMENT AND SYSTEM SERVICES LIMITED**

Labrynth Business Centre,43 Middle Hill Gate,

Stockport Great Manchester,England-SK1 3DG

Web : [www.staunchlyservices.com](http://www.staunchlyservices.com)

E-mail : [info@staunchlyservices.com](mailto:info@staunchlyservices.com)

Phone : +44 7404621007

Company Registered in England with

**PRINCIPAL**  
Vignans Institute of Management & Technology For Women  
Kondapur(V), Ghatkesar(M), Medchal-Malkajgiri(Dt)-501301  
Telangana State

